

# Instruction Manual

## DO 6+ Dissolved Oxygen/Temp



CE

**EUTECH**  
**INSTRUMENTS**

*Technology Made Easy...*

**ISO 9001**  
CERTIFIED

68X243634  
Rev 0 Mar 09

Part of Thermo Fisher Scientific

## **Preface**

This manual serves to explain the use of the DO 6+ hand held meter.

This manual functions in two ways: first as a step by step guide to help you operate the meter; second, as a handy reference guide.

This manual is written to cover as many anticipated applications of the DO 6+ meter as possible. If there are doubts in the use of this meter, please do not hesitate to contact the nearest Eutech Instruments Authorized Distributor.

Eutech Instruments will not accept any responsibility for damage or malfunction to the meter caused by improper use of the instrument.

The information presented in this manual is subject to change without notice as improvements are made, and does not represent a commitment on the part of Eutech Instruments.

Copyright © 2009

Eutech Instruments Pte Ltd

All rights reserved.

## Table of Contents

<b>1. INTRODUCTION</b>	<b>1</b>
<b>2. GETTING STARTED</b>	<b>2</b>
2.1 Description of Keypad Functions	2
2.2 Description of LCD Annunciators	3
2.3 Inserting & removing the rubber armour / stand	4
2.4 Inserting New Batteries	4
2.5 Battery Replacement	5
2.6 Connecting the Electrode	5
2.7 Electrode Information	6
2.8 Switching the Meter On	7
2.9 Changing Mode	7
<b>3. CALIBRATION</b>	<b>8</b>
3.1 General Information	8
3.2 Temperature Calibration	10
3.3 % Saturation Calibration	11
3.3.1 100% Calibration	11
3.3.2 0% Calibration	12
3.4 mg/L or ppm Calibration	13
<b>4. MEASUREMENT</b>	<b>14</b>
4.1 Temperature Compensation	14
4.2 Taking Measurements	15
4.3 Pressure & Salinity Compensated Measurements	16
4.4 Holding a Reading	16
<b>5. SETUP</b>	<b>17</b>
5.1 Configuration Menu (COF.1)	21
5.2 Automatic Temperature Compensation (A.ATC)	21
5.3 Selection of mg/L or ppm (b.DO)	22
5.4 Calibration Data (CAL.2)	22
5.5 Electrode Data (ELE.3)	23
5.6 Automatic Shut Off (AtO.4)	24
5.7 Reset to Factory Default (rSt.5)	25
5.8 % Saturation Offset Adjustment (OFS.6)	26
5.9 Pressure & Salinity Adjustment	27
<b>6. PROBE MAINTENANCE</b>	<b>29</b>
6.1 Cap and Electrolyte Replacement	30
6.2 Electrolyte Solution	31
<b>7. TROUBLESHOOTING</b>	<b>31</b>
<b>8. ERROR MESSAGES</b>	<b>32</b>

**9. FACTORY DEFAULT SETTINGS .....33**

**10. SPECIFICATIONS .....34**

**11. REPLACEMENTS AND ACCESSORIES.....36**

**12. DISSOLVED OXYGEN THEORY .....37**

Measurement Units .....38

What Is Being Measured? .....38

Air Calibration .....39

Applications .....39

**13. WARRANTY .....40**

**14. RETURN OF ITEMS.....40**

## 1. INTRODUCTION

Thank you for purchasing the DO 6+. This microprocessor-based handheld meter is economical and easy to use. It has a large custom LCD (Liquid Crystal Display) for clear and easy reading.

The DO 6+ offers measurement of dissolved oxygen (DO) as percentage saturation or concentration. Temperature measurement is also available in degrees Celsius. The meter ensures accurate measurement of the dissolved oxygen values through its temperature, barometric pressure and salinity compensation features.

Meter kits include a dissolved oxygen probe, refill solution, a rubber armour / stand, 4 alkaline "AAA" batteries, instruction manual, and warranty card. For additional information, see *Section 11 — REPLACEMENTS AND ACCESSORIES*.

Please read this manual thoroughly before operating your meter.

## 2. GETTING STARTED

### 2.1 Description of Keypad Functions

Your meter has 6 keys on its splash-proof keypad. Some buttons have multiple functions depending on the mode of operation.

**ON/OFF** Powers meter on and off. Meter starts up in the measurement mode that you last switched off from.

**CAL** Enters into calibration mode. Pressing while in calibration mode will abort calibration without confirming value.

**MODE** Selects desired measurement mode. When pressed simultaneously with ON/OFF, it will take you into the SETUP mode. For more information see *Section 5 — SETUP*.

**HOLD** Freezes measured reading. Press again to resume live reading.

**ENTER** Confirms calibration value in calibration mode and confirm selections in SETUP mode.

**▲▼** Increment/decrement values during calibration mode or scroll through SETUP menus. Set offset adjustments and configuration settings.



## 2.2 Description of LCD Annunciators

Your meter has a large custom LCD that consists of 4-digit segments plus annunciators for percentage saturation (%), concentration (mg/L or ppm) and Temperature in degrees Celsius (T).

Other annunciators include "A" (when the ATC function is activated), "CAL" (when meter is in calibration mode) and low battery condition.

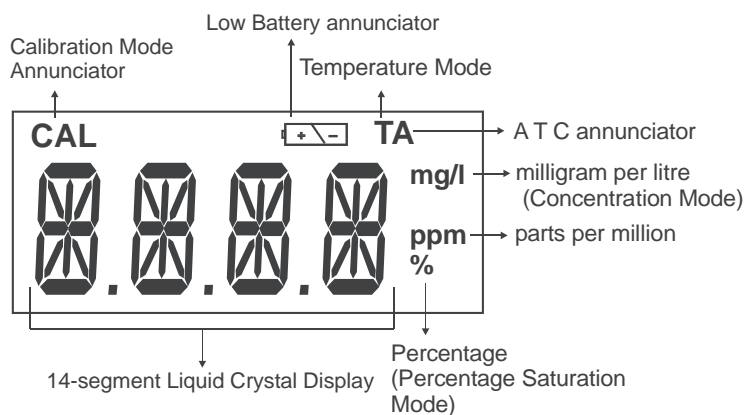

Active LCD display for DO 6+

### 2.3 *Inserting & removing the rubber armour / stand*

1. To remove meter from rubber armour, push out from the bottom edges of meter until it is completely out of boot. Ensure that your electrode cables are not connected. See **Figure 1**.
2. To insert meter into armour, slide in from the top of meter before pushing the bottom edges of meter down to set it into position. Lift up the stand at the back of meter for bench top applications if necessary. See **Figure 2**.

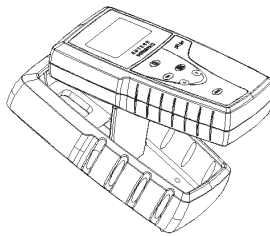

Figure 1



Figure 2

### 2.4 *Inserting New Batteries*

The battery compartment is found at the back of instrument. To open the battery compartment, push in the direction of arrow and lift up the cover. Note the polarity of battery before inserting into position. After replacement, place cover back and press down until it locks.

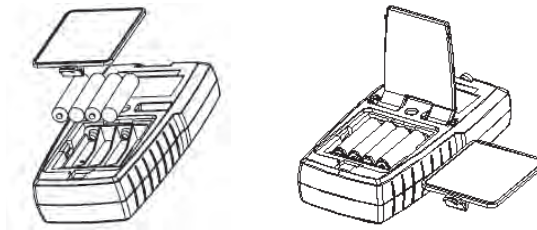

## 2.5 Battery Replacement

A low battery annunciator in the LCD alerts you when battery power is running low. *Caution: Power off the meter before replacing battery.*



**Low Battery Condition**

## 2.6 Connecting the Electrode

- 1) To connect the electrode, align the connector slots with the posts of meter's socket and rotate connector clockwise until it locks.
- 2) To remove, rotate the connector in anti-clockwise direction until it unlocks, and slide the connector off the socket.
- 3) Insert the mini phono jack of temperature sensor into the socket on the meter as shown below.

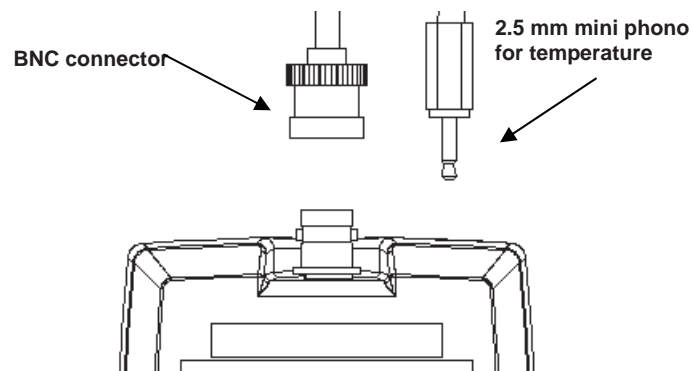

## 2.7 Electrode Information

The DO 6+ includes a galvanic DO electrode (93X233912) which doesn't require warm-up. It generates a millivolt signal proportional to the amount of oxygen in the solution.

The electrode has a dual cable; a BNC connector for DO measurement and a phono jack plug for temperature. The sensor utilizes a cathode, anode, and electrolyte that are separated from the sample by an oxygen permeable membrane. The membrane is pre-assembled for you and fixed to a detachable cap. The pre-assembled cap design allows simple replacement and fast conditioning.

The probe is light weight and includes a built-in temperature sensor. The epoxy body of the probe is 12mm diameter while the detachable Noryl cap is 16mm diameter. The compact sensing area reduces air entrapment resulting in quick, accurate, and stable readings.

The pre-assembled cap must be completely submersed to obtain an accurate reading in solutions. Provide simple stirring for best results—ideally achieve a minimum water flow rate of 2 inch/second on the membrane. The probe is not recommended beyond 0 to 50 °C.

Shaking will aid to remove bubbles if needed before taking a reading. When calibrating in air, shake to remove water from the membrane.

The membrane is thin and can not be repaired if damaged. Use care to protect from scratches, abrasion, or contact with solids. For best results keep membrane clean by rinsing after daily use. See *Section 6 – PROBE MAINTENANCE*.

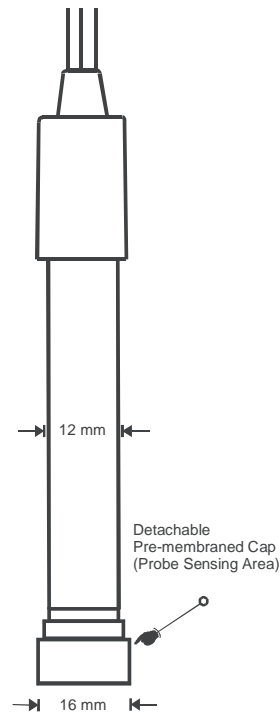

**Galvanic DO probe  
(93X233912)**

### 2.8 Switching the Meter On

Press **ON/OFF** to power up your meter. Your meter will cycle through various setup parameters when switched on.

- 1) All LCD segments will briefly illuminate.
- 2) The model [DO 6+] will display next along with mg/l, ppm, and % annunciators.
- 3) Next, the meter revision number [r #.##] is shown briefly before beginning measurement.
- 4) The meter begins with the measurement mode that was in use when it was previously powered off—%, mg/l, ppm, or T.

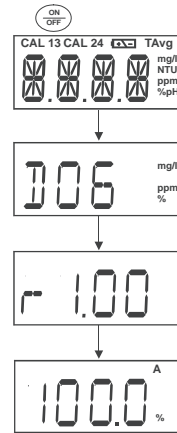

### 2.9 Changing Mode

Press **MODE** to switch between percentage saturation (%), concentration (mg/L)(ppm), and temperature (T) measurement.

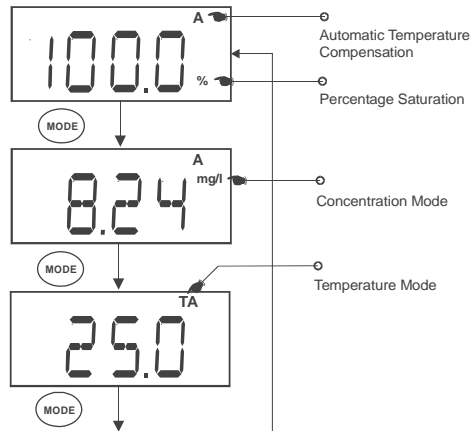

### 3. CALIBRATION

#### 3.1 General Information

The DO 6+ has three measurement modes; DO as % saturation, DO as mg/L (or ppm) concentration, and temperature.

Dissolved oxygen levels vary with temperature, barometric pressure, and salinity, so calibration must be performed with consideration of these factors. ***It is necessary to set the proper temperature, barometric pressure and salinity values prior to performing any DO calibration or measurement.***

See Section 3.2 — *Temperature Calibration*

See Section 5.2 — *Automatic Temperature Compensation.*

See Section 5.9 — *Pressure & Salinity Adjustment.*

The DO 6+ will accept two % saturation calibration points; 100% using saturated air or air-saturated water, and 0% using zero oxygen solution. When 100% calibration is performed, the corresponding concentration is adjusted simultaneously. Therefore, it is not necessary to calibrate the concentration mode. If calibrating for 0% oxygen, note that the meter will take several minutes to reach 0% saturation value and constant stirring is not required.

The following table lists calibration values in % saturation calibration mode with two different barometric pressures. Note that the saturation value (92.1%) has decreased due to the lower barometric pressure entered.

% Saturation (per factory default value)	Calibration Value (760mmHg)	Calibration Value (700mmHg)
less than 10%	0%	0%
10.1% to 49.9%	Err.1 (error 1)	Err.1 (error 1)
50% to 200%	100%	92.1%

If calibration is attempted from 10.1% to 49.9%, the “Err.1” message is shown—calibration is rejected and the display will return to measurement mode.

The DO 6+ will accept one calibration point in concentration mode. The minimum value is 2 mg/L (ppm), and the calibration window is +/- 40% of the factory default value.

Temperature and % saturation calibration should take place **before** attempting to perform mg/L (ppm) concentration calibration.

Calibration of the concentration mode will only replace the previous concentration calibration and does not affect the % saturation calibration.

To offset your % saturation reading to match another instrument, see *Section 5.8 — % Saturation Offset Adjustment*.

New calibration values will automatically override the existing data. Perform daily calibration for best results. To completely recalibrate the meter and when installing a replacement electrode, it is best to clear all calibration data. See *Section 5.7 Reset to Factory Default*.

### 3.2 Temperature Calibration

For best DO accuracy, ensure that the temperature is accurate. The temperature sensor of the DO 6+ probe has been factory calibrated, however if it changes over time or if the probe is replaced, calibration may be necessary. To protect from erroneous calibrations, the allowable tolerance is limited to  $\pm 5^{\circ}\text{C}$  adjustment of the factory default value.

Most users utilize automatic temperature compensation using the sensor that is built into the probe. However, manual temperature compensation can be used to input a fixed, known temperature.

- 1) Press **MODE** to select temperature mode. The display should show "T" for temperature and "A" for automatic temperature compensation.
- 2) Dip the probe into a solution with a known, accurate temperature (i.e. a temperature bath). Allow enough time for the temperature reading to stabilize.
- 3) Press **CAL**. The CAL indicator will blink above the display. The temperature value shown is the value based on the factory default.
- 4) Press **▲ ▼** to adjust the reading to match the correct temperature value (i.e. of the temperature bath).
- 5) Press **HOLD/ENTER** to confirm the calibration and return to measurement mode.

Press **CAL** as needed to exit calibration without confirmation at any time.

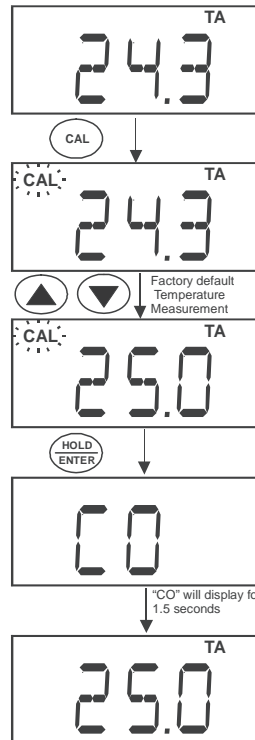

### 3.3 % Saturation Calibration

The DO6+ can be easily calibrated in air. For best DO accuracy, ensure that the barometric pressure value is accurate.

The barometric pressure factory default is 760 mm Hg, which results in a theoretical calibration value of 100% saturation in air. If the barometric pressure setting has been changed from 760 mm Hg, the meter will automatically adjust to a new % saturation calibration value instead of 100%. This new value is correct for the adjusted barometric pressure.

#### 3.3.1 100% Calibration

- 1) Rinse the probe well with DI water or rinse solution.
- 2) Press **MODE** to select % saturation.
- 3) Hold the probe in the air with the tip facing downwards. Wait for the reading to stabilize.
- 4) Press **CAL**. The CAL indicator and intended percentage calibration point (100%) display briefly, before CAL flashes. The % value based on the factory default calibration is shown.
- 5) Press **HOLD/ENTER** to confirm the calibration. The meter displays "CO", automatically calibrates to 100.0% air saturation, then returns to measurement mode.

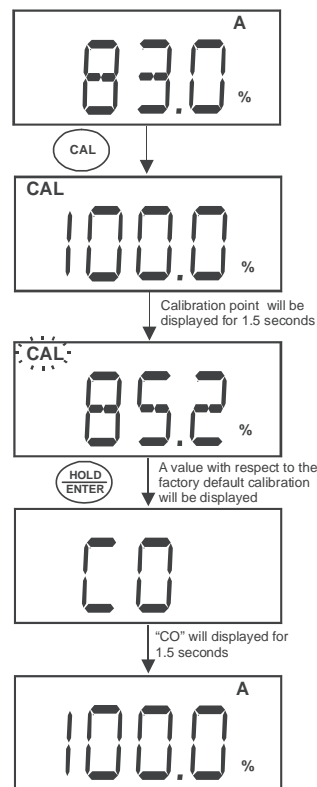

**3.3.2 0% Calibration**

- 1) Rinse the probe well with DI water or rinse solution.
- 2) Press **MODE** to select % saturation.
- 3) Dip the probe into zero oxygen solution. Wait for the reading to stabilize.
- 4) Press **CAL**. The CAL indicator and intended percentage calibration point (0%) display briefly, before CAL flashes. The % value based on the factory default calibration is shown.
- 5) Press **HOLD/ENTER** to confirm the calibration. The meter displays "CO", automatically calibrates to 0.0% saturation, then returns to measurement mode.

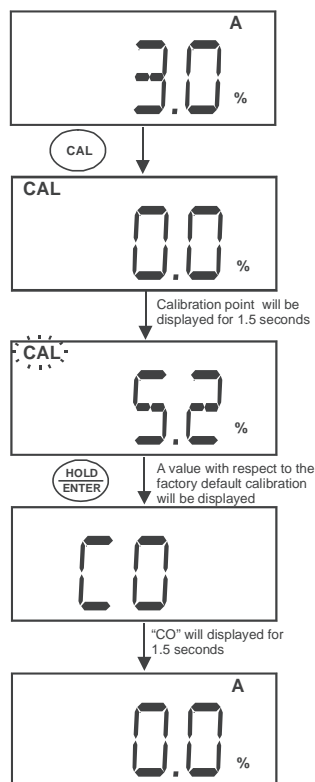

### 3.4 mg/L or ppm Calibration

Performing a 100% saturation calibration will simultaneously calibrate the corresponding mg/L (ppm) concentration value. Therefore, additional mg/L (ppm) calibration isn't required in most circumstances.

If desired, you can perform a calibration adjustment in mg/L (ppm) without affecting your % saturation calibration value.

- 1) Perform 100% saturation calibration. See Section 3.3.1 — 100% Calibration.
- 2) Rinse the probe well with DI water or rinse solution.
- 3) Dip the probe into a sample of known oxygen concentration (i.e. determined by titration or another instrument). Wait for the reading to stabilize.
- 4) Press **MODE** to select the mg/L (ppm).
- 5) Press **CAL**. The CAL indicator and current concentration display briefly, before CAL flashes. The concentration value based on the factory default calibration is shown.
- 6) Press **▲ ▼** to adjust the reading to match the known oxygen concentration value.
- 7) Press **HOLD/ENTER** to confirm the calibration. The meter displays "CO", automatically calibrates to the entered value, then returns to measurement mode.

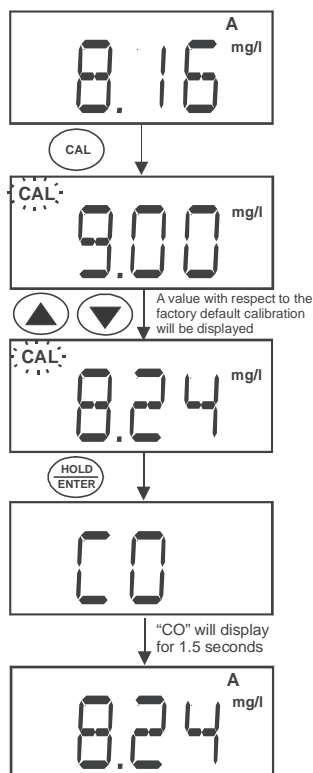

**NOTE:** The minimum calibration value is 2 mg/L. To prevent erroneous calibrations, the calibration is limited to  $\pm 40\%$  adjustment of the factory default value.

## 4. MEASUREMENT

The DO 6+ offers automatic or manual temperature compensation. See Section 5.2 — *Automatic Temperature Compensation*.

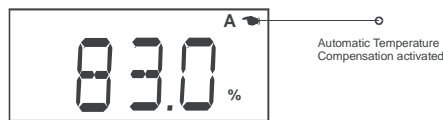

### 4.1 Temperature Compensation

Insert the phono plug of the probe for Automatic Temperature Compensation (ATC). The "A" annunciator will display normally when active, or blink if the phono plug is disconnected.

Deactivate "A.ATC" for manual temperature compensation. The "A" annunciator is not displayed when the meter is in manual temperature compensation mode.

For manual temperature compensation, manually enter the desired process temperature into the meter from 0 and 50 °C. Default is 25 °C.

- 1) Press **MODE** to select temperature.
- 2) Press **CAL**. The "CAL" indicator will start blinking and the display will show the last manually set temperature value.
- 3) Check the temperature of your sample using an accurate reference thermometer. Wait for the value to stabilize. Press ▲ ▼ to manually set the temperature value.
- 4) Press **HOLD/ENTER** to confirm the calibration. The meter displays "CO", automatically sets the entered value, then returns to measurement mode.

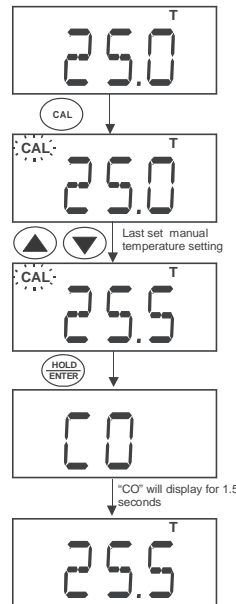

## 4.2 Taking Measurements

Follow these general rules when taking measurements: keep the membrane free from contact with solid objects, provide stirring of your solution—this helps to overcome the oxygen consumption of the probe and prevents air bubble entrapment, do not strike against hard surfaces, and do not submerge the cable for extended periods.

- 1) Rinse the probe well with DI water or rinse solution.
- 2) Select the appropriate measurement mode. Press **MODE** to toggle between modes:
  - a. Percentage Saturation (%)
  - b. Concentration (mg/L) or (ppm)
  - c. Temperature (T)
- 3) Dip the probe into the sample.
- 4) Allow reading to stabilize and observe reading.

To change the concentration units see *Section 5.3—Selection of mg/L or ppm.*

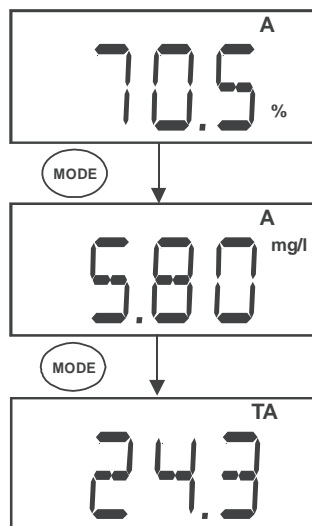

### 4.3 Pressure & Salinity Compensated Measurements

During measurement the dissolved oxygen reading is automatically compensated for salinity and pressure based on values entered in the setup menu. For best DO accuracy, ensure pressure and salinity are adjusted accordingly from the setup menu. The factory default values are 760 mm Hg (101.3 kPa) barometric pressure (sea level) and 0.0 ppt salinity (no salinity). See Section 5.9 — Pressure & Salinity Adjustment.

### 4.4 Holding a Reading

To hold the displayed reading momentarily, press **HOLD/ENTER** during any measurement. The %, mg/L, ppm or T annunciator will blink, indicating that the value is held.

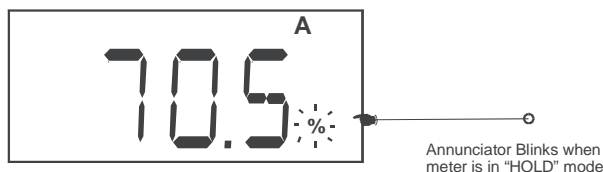

Press **HOLD/ENTER** again to deactivate the HOLD function. The meter reverts to the current active measurement and the annunciator will stop blinking.

If the auto-off feature is activated, the meter will turn off automatically after 20 minutes of non use. The HOLD value is not retained when the meter is shut off automatically or manually.

## 5. SETUP

There are two setup menus. One menu is derived from the % saturation and temperature modes, the other menu is derived from the mg/L (or ppm) concentration mode.

- 1) Press **MODE** to display % or temperature. Press **ON/OFF** to power off.

OR

Press **MODE** to display mg/L (or ppm). Press **ON/OFF** to power off.

- 2) With the meter off, keep the **MODE** key pressed. Press and release **ON/OFF**, then release **MODE**. The meter should display "SEt.P" after **ON/OFF** is released and "COF.1" after **MODE** is released.

Press **CAL** one or more times as needed during setup mode to exit and return to measurement mode at any time.

SEt.P	Setup Menu
COF.1	Configuration Menu <b>A.ATC</b> Automatic Temperature Compensation <b>b.DO</b> Select mg/L or ppm units for concentration mode (available from concentration setup only)
CAL.2	View the latest calibration data according to the respective setup menu.
ELE.3	View the electrode properties <b>FACT</b> View the slope factor <b>OFS</b> View the % saturation offset adjustment. (available from % saturation concentration setup only) <b>HI.mV</b> View the mV value at 100% saturation <b>LO.mV</b> View the mV value at 0% saturation
AEO.4	Selection of automatic power-off (20 min from the last key press)
RSt.S	Reset Menu <b>A.CAL</b> Calibration only reset to factory default <b>b.USR</b> User settings reset to factory default
OFS.6	% saturation offset adjustment (available from % saturation concentration setup only)
DPr.7	Dissolved Oxygen Parameters <b>A.HG</b> Barometric pressure adjustment in mmHg <b>A.PA</b> Barometric pressure adjustment in kilopascal <b>b.SAL</b> Salinity adjustment (available from concentration setup only)

**MODE** Switch off from % Saturation or Temperature measurement mode. Press and hold MODE key and then switch on.

**ON**  
**OFF**

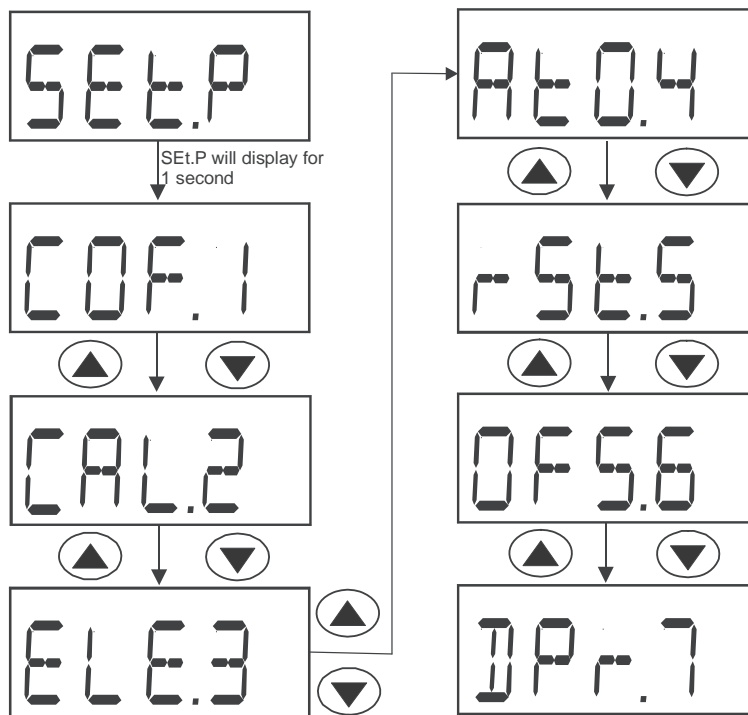

% or Temperature Setup Menu

**MODE** Switch off from Concentration measurement mode. Press and hold MODE key and then switch on.

**ON OFF**

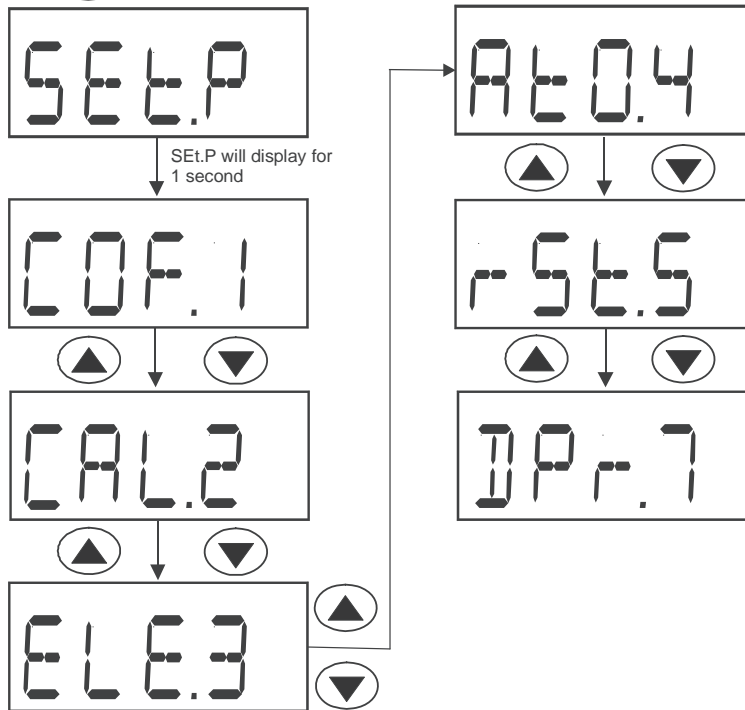

mg/L (ppm) Concentration Setup Menu

### 5.1 Configuration Menu (COF.1)

### 5.2 Automatic Temperature Compensation (A.ATC)

Use this menu to change automatic temperature compensation (A) or units of concentration (mg/L or ppm). ATC is recommended for most applications.

- 1) From "COF.1" of either setup menu, press **HOLD/ENTER** to display "A.ATC".
- 2) Press **HOLD/ENTER** to enter the selection menu.
- 3) Use ▲▼ to select YES (activate ATC) or NO (deactivate ATC and activate manual temperature compensation).
- 4) Press **HOLD/ENTER** to confirm.
- 5) Press **CAL** to return to measurement mode.

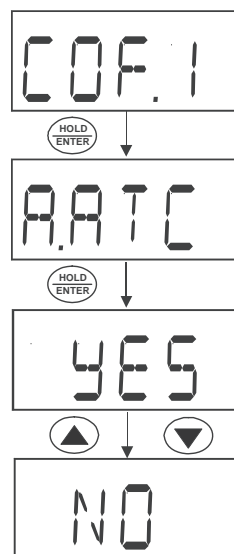

Selection of Automatic or Manual Temperature Compensation

### 5.3 Selection of mg/L or ppm (b.DO)

- 1) From "COF.1" of the mg/L (ppm) setup menu, press **HOLD/ENTER** three times to display "b.DO".
- 2) Use ▲▼ to select the desired units of measurement.
- 3) Press **HOLD/ENTER** to confirm.
- 4) Press **CAL** to return to measurement mode.

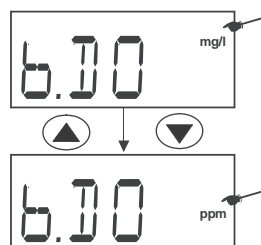

### 5.4 Calibration Data (CAL.2)

To view the % saturation or mg/L (ppm) concentration calibration data, proceed from the corresponding setup menu.

- 1) From the setup menu, press ▲▼ to select "CAL.2" for the most recent calibration data.
- 2) Press **HOLD/ENTER** to view calibration data.
- 3) Press **HOLD/ENTER** or **CAL** to exit.
- 4) Press **CAL** to return to measurement mode.

Note: " - - - - - " indicates no calibration data exists for the selected mode.

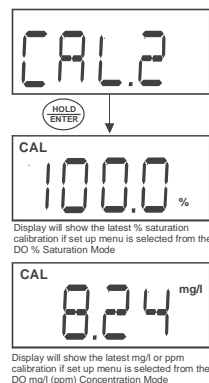

### 5.5 *Electrode Data (ELE.3)*

Use this menu to view electrode data for diagnostic purposes. Data includes; slope factor (FACT), % saturation offset (OFS), 100% saturation mV value (HI.mV), and 0% saturation mV value (LO.mV). To view electrode data for % saturation or mg/L (ppm) modes, enter from the corresponding setup menu.

The electrode slope factor gives an indication of the probe's efficiency. It is the ratio of the actual mV produced by the probe to the theoretical mV value. The ratio displays from 0.5 to 1.999.

The % saturation offset allows you to view the electrode offset adjustment made in Section 5.8 — % Saturation Offset Adjustment.

- 1) From the setup menu, press ▲ ▼ to select "ELE.3".
- 2) Press **HOLD/ENTER** to enter the menu. "FACT" is momentarily shown before displaying the slope factor.
- 3) Press **HOLD/ENTER** again. "OFS" is momentarily shown before displaying % saturation offset. Note: this is not available from the mg/L (ppm) concentration setup menu.
- 4) Press **HOLD/ENTER** again. "HI.mV" is momentarily shown before displaying the electrodes mV output at 100%.
- 5) Press **HOLD/ENTER** again. "LO.mV" is momentarily shown before displaying the electrodes mV output at 0%.

Press **CAL** to exit the setup mode and return to measurement mode at any time.

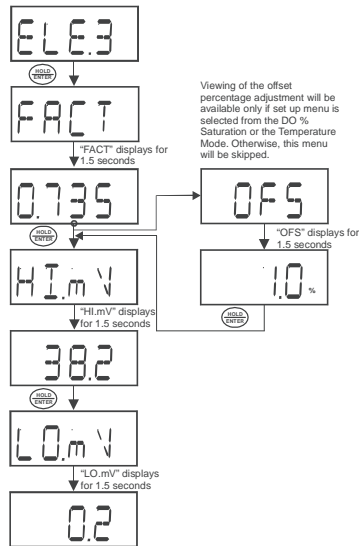

### 5.6 Automatic Shut Off (AtO.4)

Use this feature to conserve batteries. When active, the meter will automatically shut off 20 minutes after the last key press.

- 1) From the setup menu, press **▲▼** to select "AtO.4".
- 2) Press **HOLD/ENTER** to enter the menu.
- 3) Use **▲▼** to select YES (activate automatic off) or NO (activate automatic off).
- 4) Press **HOLD/ENTER** to confirm.
- 5) Press **CAL** to return to measurement mode.

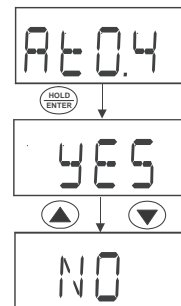

### 5.7 Reset to Factory Default (rSt.5)

Use this mode to reset the meter to factory default settings. There are two levels of reset.

**Calibration (A.CAL)** resets calibration values only.

**User (b.USR)** resets all data, calibration, and other customized setup functions.

- 1) From the setup menu, press ▲▼ to select "rSt.5".

- 2) Press **HOLD/ENTER** to enter the menu.

- 3) Press **HOLD/ENTER** to enter calibration reset "A.CAL".

- 4) Use ▲▼ to select YES (reset calibration) or NO (do not reset calibration).

- 5) Press **HOLD/ENTER** to confirm. If "YES", the meter returns to measurement mode after resetting.

Note: Both % and concentration calibrations are reset when from the % saturation setup. However, when calibration reset occurs from the concentration setup, only concentration is reset.

- 6) If "NO", the User Reset menu "b.USR" is displayed.

- 7) Press **HOLD/ENTER** to enter the menu.

- 8) Use ▲▼ to select YES (reset user) or NO (do not reset user).

- 9) Press **HOLD/ENTER** to confirm.

- 10) If "YES", the meter returns to measurement mode after resetting.

- 11) Press **CAL** to return to measurement mode.

### 5.8 % Saturation Offset Adjustment (OFS.6)

Use this feature to offset the meter's value when cross referenced to another DO meter. The DO 6+ allows +/- 10.0% offset adjustment. View the offset value from the Electrode Data menu "ELE.3".

- 1) Using the % saturation mode of your DO6+, observe the reading a sample solution after it has stabilized.
- 2) Similarly, observe the reading of the same sample using another DO meter as a reference. The probe of the reference meter should be immersed in the same sample at the same depth.
- 3) Switch off the DO6+ and enter the % saturation setup menu.
- 4) Press ▲▼ to select "OFS.6".
- 5) Press **HOLD/ENTER** to enter the menu. The display will momentarily show the measured reading based on the last calibration before displaying the last offset adjusted value.
- 6) Use ▲▼ to enter the value of the reference DO meter.
- 7) Press **HOLD/ENTER** to confirm.
- 8) Press **CAL** to return to measurement mode.

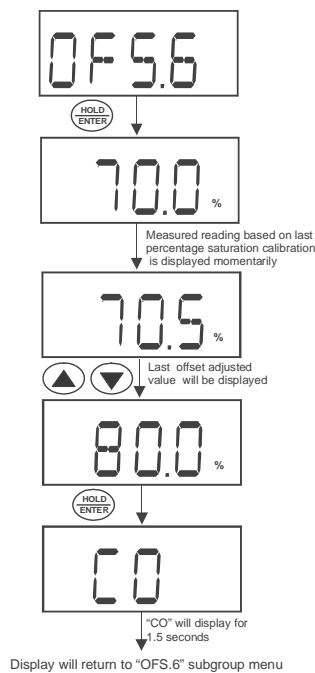

**Note: User calibrations will reset the offset adjustment to 0.0 %.**

### 5.9 Pressure & Salinity Adjustment

Use this menu to set barometric pressure and salinity values of the sample to be measured. Use mmHg (A.HG) or kilopascal (A.PA) barometric pressure units, and ppt salinity units (bSAL) from concentration setup menu. For best accuracy, enter the actual salinity value if your samples are at least 0.1 ppt (100 ppm). Maximum adjustment is 50 ppt (50,000 ppm or 5% salt).

- 1) Press **MODE** to display mg/L concentration. Press **ON/OFF** to power off.
- 2) With the meter off, keep the **MODE** key pressed. Press and release **ON/OFF**, then release **MODE**. The meter should display "SEt.P" after ON/OFF is released and "COF.1" after **MODE** is released.
- 3) Press **▲▼** until the display shows "DPr.7".
- 4) Press **HOLD/ENTER**. The display will show the current setting, either "A.HG" (millimeters of mercury or mm Hg) or "A.PA" (kilopascal or kPa).
- 5) Use **▲▼** to select the desired barometric pressure units, then press **HOLD/ENTER** to confirm.
- 6) Use **▲▼** to set the actual pressure value and press **HOLD/ENTER** to confirm. If values were changed, the confirmation indicator "CO" will display briefly.
- 7) Next, "b.SAL" (salinity adjustment) will display. "DPr.7" (main group menu) will display if mg/L was not used in step 1). Note: if the concentration setup was not used in step 1) the meter will return to "DPr.7" as salinity is only accessible thru concentration setup.
- 8) Press **CAL** to return to measurement mode or **HOLD/ENTER** for salinity setting adjustment.
- 9) Use **▲▼** to enter the salinity of your solution in parts per thousand (ppt).
- 10) Press **HOLD/ENTER** to confirm. If values were changed, a confirmation indicator "CO" will display briefly.
- 11) Press **CAL** to return to measurement mode.

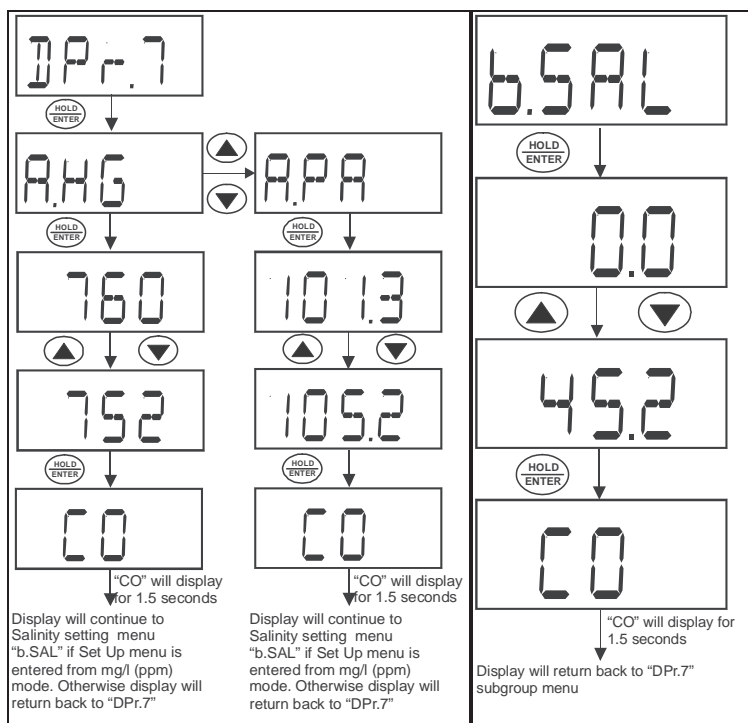

Pressure & Salinity Adjustment Sequences

## 6. PROBE MAINTENANCE

The DO 6+ probe is a galvanic measuring element which produces an output proportional to the oxygen present in the medium in which it is placed. The galvanic probe design lets you take measurements immediately – without the typical 15 minute wait of polarographic dissolved oxygen probes.

The probe consists of two parts. The upper part consists of the anode, cathode, and dual cable. The lower part consists of a pre-assembled cap, and electrolyte solution.

Oxygen diffuses through the membrane onto the cathode, where it is consumed. This process produces an electrical current which flows through the cable to the meter. The electric current produced is proportional to the oxygen that passes through the membrane and the layer of electrolyte. This makes it possible to measure the partial pressure of oxygen in the sample at a given temperature.

Since the DO in the sample is consumed by the cathode it is essential to have flow past the membrane of the probe to prevent the occurrence of false readings. The probe uses very little oxygen for its measurement. This enables it to function correctly with liquid movement as low as 2 inch/sec across membrane.

The permeability of the membrane to oxygen varies greatly with temperature. Therefore compensation is needed for this variation. The DO 6+ probe comes with built-in temperature compensation for the membrane variation.

Proper maintenance will help you maximize probe life and accurate readings.

Deposits on the membrane surface act as a barrier to oxygen diffusing through the membrane, so clean the membrane to assure maximum reliability.

After each use, rinse the probe with clean water to avoid any hardening of deposits. If growth develops on the probe, use a disinfecting chemical to clean.

**NOTE:** Although the membrane is strong and not easily damaged, wipe it gently while cleaning it. If the membrane is punctured, damaged, or torn, the probe will not function properly.

There are no special probe storage requirements.

### 6.1 Cap and Electrolyte Replacement

Replacement of the pre-assembled cap is required only when you cannot calibrate the probe, or if the membrane is damaged. Typical membrane damages are punctures or wrinkles caused during measurements or cleaning.

For part numbers, see *Section 11 – REPLACEMENTS AND ACCESSORIES*.

- 1) Unscrew the cap counter clockwise from the probe sensing tip.
- 2) Rinse the probe under running water.
- 3) Mount the nozzle tip onto the syringe provided. Fill the syringe with the refill solution through the tip of the plastic bottle.
- 4) Hold the probe upside down. Insert the nozzle tip into one of the 4 holes surrounding the silver cathode. Inject the fill solution into the probe body until solution leaks out from the fill hole (approximately 5 mL).
- 5) Replace pre-assembled cap by tightening clockwise until hand tightened.
- 6) Allow at least 1 hour for the electrode to equilibrate before usage.

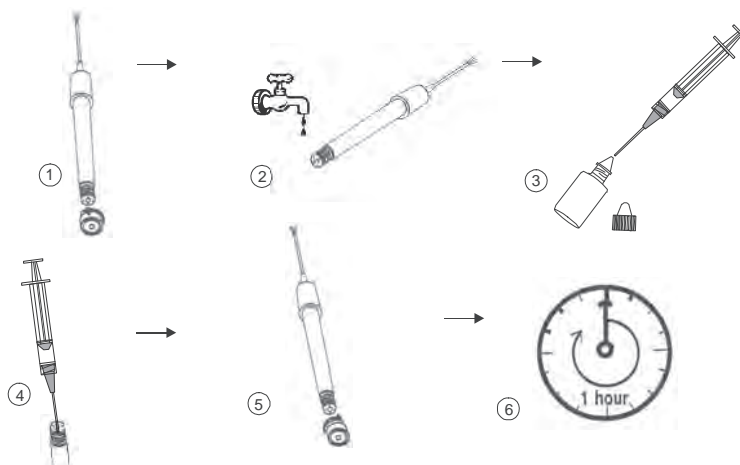

## 6.2 Electrolyte Solution

The electrolyte solution in your probe's cap will deplete on usage and will need to be replaced periodically. The replacement electrolyte solution included with your probe comes premixed and ready to use. To order more electrolyte solution, *Section 11 – REPLACEMENTS AND ACCESSORIES*.

## 7. TROUBLESHOOTING

Problem	Cause	Solution
No display when turned on	<ul style="list-style-type: none"> <li>a) Batteries not in place</li> <li>b) Batteries not in correct polarity (+ / – position)</li> <li>c) Weak batteries</li> </ul>	<ul style="list-style-type: none"> <li>a) Ensure batteries are in place and making good contact</li> <li>b) Re-insert batteries with correct polarity</li> <li>c) Replace batteries</li> </ul>
Unstable readings	<ul style="list-style-type: none"> <li>a) Insufficient electrolyte in probe</li> <li>b) Air bubbles trapped around the probe</li> <li>c) Dirty or damaged probe</li> <li>d) Probe not deep enough in sample</li> <li>e) External noise pickup or induction caused by nearby electric motor</li> <li>f) Broken probe</li> </ul>	<ul style="list-style-type: none"> <li>a) Fill probe with electrolyte &amp; / or replace pre-assembled cap</li> <li>b) Stir or tap probe to remove bubbles</li> <li>c) Clean the probe and re-calibrate</li> <li>d) Make sure sample entirely covers the probe sensors</li> <li>e) Move or switch off interfering motor</li> <li>f) Replace probe</li> </ul>
Slow response	<ul style="list-style-type: none"> <li>a) Dirty / Oily probe</li> <li>b) Temperature is changing</li> </ul>	<ul style="list-style-type: none"> <li>a) Clean probe</li> <li>b) Allow temperature to stabilize</li> </ul>
No response to key press	<ul style="list-style-type: none"> <li>a) HOLD in use- indicated by flashing display</li> <li>b) Damaged pad</li> <li>c) Internal program error</li> </ul>	<ul style="list-style-type: none"> <li>a) Press HOLD/ENTER</li> <li>b) Return to dealer</li> <li>c) Reset by reinserting batteries</li> </ul>

## 8. ERROR MESSAGES

LCD Display	Indicates	Cause	Solution
	Low battery	Need new batteries or battery connection is bad.	Clean battery contacts. Replace batteries, noting polarity.
"Err 1" in % Saturation Mode	% Saturation calibration error	Calibration is attempted when the factory calibrated absolute value is within 10.1% to 49.9%	Check the value of the calibration solution. If zero calibration is done, make sure the limit of 10% is not exceeded Recondition your probe
"Err. 1" in mg/L (ppm) Concentration Mode	Concentration calibration error	Calibration is attempted when the factory calibrated absolute value is below 2.00	Verify the solution is above 2.00 Verify the temperature and salinity settings Recondition your probe
"UR"/"OR" with blinking "A" annunciator in Temperature Mode	ATC probe error, Under Range, Over Range	ATC probe is disconnected or broken with the ATC feature activated. Temperature is out of range	Connect the ATC plug to the meter. Verify the temperature accuracy. Ensure probe is not broken or punctured.
"----" with blinking "A" annunciator in % Saturation and Concentration Mode	ATC probe error	ATC probe is disconnected or broken with the ATC feature activated. Temperature is out of range	Connect the ATC plug to the meter. Verify the temperature accuracy. Ensure probe is not broken or punctured.

## 9. FACTORY DEFAULT SETTINGS

MENU	DESCRIPTION	OPTIONS	DEFAULT
COF.1	Configuration Setup Menu		
A.ATC	Automatic Temperature Compensation	YES / NO	YES
b.DO	DO Concentration Units	mg/L or ppm	mg/L
CAL.2	Calibration Data	View only	----
ELE.3	Electrode Data Menu		
FACT	Electrode Slope Factor	View only	1.000
OFS	Viewing the % Saturation offset adjustment.	View only	0.0%
HI.mV	View mV Value at 100% Saturation	View only	50 mV
LO.mV	View mV Value at 0% Saturation	View only	0 mV
AtO.4	Automatic Power Off	YES / NO	YES
rSt.5	Reset to Factory Default Menu		
A.CAL	Selection of Calibration Reset	NO / YES	NO
b.USR	Selection of User Reset	NO / YES	NO
OFS.6	% Saturation Offset Adjustment	+/- 10.0%	0.0%
DPr.7	Dissolved Oxygen Parameters Menu		
A.HG	Pressure Adjustment in mm Hg	500 – 1499	760
A.PA	Pressure Adjustment in kPa	66.6 - 199.9	101.3
b.SAL	Salinity Adjustment in ppt	0.0 - 50.0	0.0
	Manual Temperature Compensation	0.0 - 50.0 °C	25.0°C

## 10. SPECIFICATIONS

% Saturation Mode Range Resolution Relative accuracy	0.00 – 200.0 % 0.1 % ± 1.5% of Full Scale
mg/L (ppm) Concentration Mode Range Resolution Relative accuracy	0.00 – 20.00 mg/L or ppm 0.01 mg/L; 0.01 ppm ± 1.5% of Full Scale
Temperature Range Resolution Relative accuracy	-5.0 – 105.0 °C (meter only)* 0.1 °C ± 0.5 °C  <i>*Probe measures 0.0 – 50.0 °C</i>
Salinity Correction Range Resolution Method	0.0 – 50.0 ppt 0.1 ppt Automatic correction after manual input
Barometric Pressure Correction (mm Hg) Range Resolution Method	500 to 1499 mm Hg or 66.6 to 199.9 kPA 1 mm Hg or 0.1 kPA Automatic correction after manual input
Automatic Temperature Compensation	0.0 to 50.0°C
Manual Temperature Compensation	0.0 to 50.0°C
Probe (DO / Temp)	Galvanic / Thermistor
Probe Diameter	Body 12 mm, Cap 16 mm
Response Time	60 seconds to achieve 95% of the reading
% Saturation Calibration Points	100% in saturated air or air-saturated water. 0% in zero oxygen solution

% Saturation Calibration Limits	Factory calibrated absolute value of 10.0% and below for 0% point & 50% to 200% for 100% point.
Concentration Calibration Window	+/- 40% from the factory default measurement value. Minimum reading allowed is 2.00 mg/L (ppm).
Temperature Calibration Window	+/- 5°C from factory default measurement
Offset Adjustments (% Saturation)	+/- 10.0 of reading in Saturation mode
HOLD function	Yes
Auto-Off function	Selectable Auto Off function. (20 minutes after last press)
Display	Custom Single 4 Digit LCD
Inputs	BNC for DO & 2.5 mm Phono for temperature
Operating Range	0 to 50 °C
Power Requirements	4 AAA-sized batteries (included)
Battery Life	> 700 hours (Alkaline Batteries)
Dimensions	Meter: 15.7 x 8.5 x 4.2 cm / 255 g Probe: 115 mm x 12 mm (Dia), 3-ft cable Membrane housing: 16 mm (Dia)

## 11. REPLACEMENTS AND ACCESSORIES

Description	Order Code Part Number
DO 6+ Dissolved Oxygen Meter in Hard Plastic Carry Case	ECDO600PLUSK 01X370112
DO 6+ Dissolved Oxygen Meter with 3 m Cable Electrode, (2) Assembled Membrane Cap Housing, Refilling Electrolyte (10-mL) & Carrying Kit Set	ECDO602PLUSK 01X370113
DO 6+ Dissolved Oxygen Meter with 1 m Cable Electrode, 2 Assembled Membrane Cap Housing, Refilling Electrolyte (10-mL) & Carrying Kit Set	ECDO601PLUSK 01X370114
DO probe, 10-mL electrolyte and plastic syringe, 3 m Cable	ECDO6HANDY3M 01X233916
DO probe, 10 mL electrolyte and plastic syringe, 1 m Cable	ECDO6HANDY 01X233913
Hard Plastic Carry Case with (4) sample Bottles (60 mL)	ECECODRYKIT 01X266903
Replacement Rubber Armour / Stand	15X410401
Assembled Membrane Cap	01X241608
Assembled Membrane Cap, 10-mL electrolyte, plastic syringe	01X241609
DO probe electrolyte refilling solution	01X211226 (50 mL)
Replacement Alkaline AAA batteries	60X023200

## 12. DISSOLVED OXYGEN THEORY

Dissolved Oxygen (DO) refers to the volume of oxygen that is contained in water. There are two main sources of DO in water; atmosphere and photosynthesis. Waves and tumbling water mix air into the water where oxygen readily dissolves until saturation occurs. Oxygen is also produced by aquatic plants and algae during photosynthesis.

The amount of DO that can be held by water depends on 3 factors:

- 1) **TEMPERATURE:**  
DO increases with decreasing temperature  
(colder water holds more oxygen)
- 2) **SALINITY:**  
DO increases with decreasing salinity  
(freshwater holds more oxygen than saltwater does)
- 3) **ATMOSPHERIC PRESSURE:**  
DO decreases with decreasing atmospheric pressure  
(amount of DO absorbed in water decreases as altitude increases)

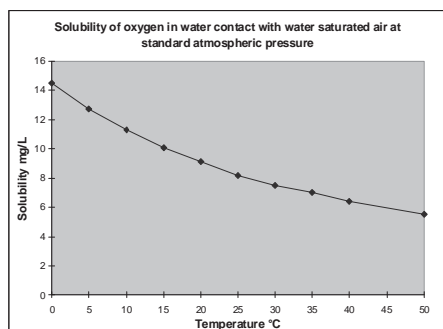

DO Solubility in Water vs Temperature

### **Measurement Units**

One measure of DO in water is parts per million (ppm) which is the number of oxygen molecules (O<sub>2</sub>) per million total molecules in a sample. Calculating the % Saturation is another way to analyze DO levels. % Saturation is the measured DO level divided by the greatest amount of oxygen that the water could hold under various temperature and atmospheric pressure conditions multiplied by 100.

### **What Is Being Measured?**

DO probes respond to the partial pressure of oxygen in liquid or gas being measured – they measure the “pressure” of oxygen rather than concentration. All of the oxygen entering the probe is consumed at the cathode where it is electrochemically reduced to hydroxyl ions producing an electrical current within the probe:

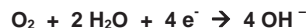

Since all oxygen entering the probe is chemically consumed, the partial pressure of oxygen in the electrolyte is zero. Therefore, a partial pressure gradient exists across the membrane and the rate at which oxygen enters the probe is a function of the partial pressure of oxygen in the gas or in liquid being measured.

When a probe is placed in air saturated water, the current it produces will not be affected by the temperature or salinity of the water. The DO concentration in the water, however, will vary with temperature and salinity. Because it is convenient to report DO concentration in mg/L or ppm, it is necessary to adjust for temperature and salinity of the water to get correct readings in these units.

If DO were to be reported in terms of partial pressure or % Saturation, then temperature and/or salinity compensation for oxygen solubility would not be necessary. Most probes are temperature compensated – i.e. they convert the “partial pressure measurement” to mg/L of DO at whatever temperature the water happens to be at for a given salinity and barometric pressure.

### ***Air Calibration***

Understanding the principle of air calibration is easy, once you know that it is partial pressure that the probe is responding to. When the probe is in air, it is measuring the partial pressure of oxygen in air. If water is air saturated, then the partial pressure of oxygen in the water will be the same as it is in air. Therefore, all you need to know is the temperature of the air in which the probe is placed. By consulting solubility tables for oxygen at the particular barometric pressure and salinity of the water being measured, the corresponding concentration (mg/L or ppm) can be found for air saturated water at the air calibration temperature, and the meter can be set accordingly. Because most meters are temperature compensated, they will still give correct readings in mg/L even though the actual water temperature may be different to the air calibration temperature. Note: The closer the air calibration temperature is to the water temperature, the more accurate the calibration.

### ***Applications***

Oxygen is essential for fish, invertebrate, plant, and aerobic bacteria respiration. DO levels below 3 ppm are stressful to most aquatic organisms. Levels below 2 or 1 ppm will not support fish. Fish growth and activity usually require 5 to 6 ppm of DO, an important consideration for Aqua-culture industry.

Low DO indicates a demand on the oxygen of the system. Natural organic material such as leaves accumulate in the stream and create an oxygen demand as it is decomposed. Organic materials from human activities also create an oxygen demand in the system. Micro-organisms consume oxygen as they decompose sewage, urban and agricultural run-off, and discharge from food-processing plants, meat-packing plants and dairies. There is an optimum DO level for this process and if DO level falls too low, the micro-organisms die and the decomposition ceases. If DO level is too high, more power is used than necessary for aeration and the process becomes costly.

In boiler water application, presence of oxygen in the water will increase corrosion and helps build up boiler scale that inhibits heat transfer. In such instance it is critical to keep DO concentration to a minimum.

Some pollutants such as acid mine drainage produce direct chemical demands on oxygen in the water. DO is consumed in the oxidation-reduction reactions of

introduced chemical compounds such as nitrate ( $\text{NO}_3^{1-}$ ) and ammonia ( $\text{NH}_4^{1+}$ ), sulfate ( $\text{SO}_4^{2-}$ ), and sulfite ( $\text{SO}_3^{2-}$ ) and ferrous ( $\text{Fe}_2^+$ ) and ferric ( $\text{Fe}_3^+$ ) ions.

These are important consideration for water and wastewater treatment industry.

### 13. WARRANTY

This meter is supplied with a three-year warranty, six-month warranty for electrode against significant deviations in material and workmanship.

If repair or adjustment is necessary and has not been the result of abuse or misuse within the designated period, please return – freight pre-paid – and correction will be made without charge. Eutech Instruments will determine if the product problem is due to deviations or customer misuse.

Out of warranty products will be repaired on a charged basis.

#### Exclusions

The warranty on your instrument shall not apply to defects resulting from:

- Improper or inadequate maintenance by customer
- Unauthorized modification or misuse
- Operation outside of the environment specifications of the products

### 14. RETURN OF ITEMS

Authorization must be obtained from our Customer Service Department or authorized distributor before returning items for any reason. A "Return Goods Authorization" (RGA) form is available through our Authorized Distributor. Please include data regarding the reason the items are to be returned. For your protection, items must be carefully packed to prevent damage in shipment and insured against possible damage or loss. Eutech Instruments will not be responsible for damage resulting from careless or insufficient packing. A restocking charge will be made on all unauthorized returns.

***Eutech Instruments Pte Ltd reserve the right to make improvements in design, construction, and appearance of products without notice.***