

# AMS Trex™ 2 Device Communicator

## User Guide



### Copyright and trademark information

©2025 Emerson. All rights reserved.

FOUNDATION™, HART® and WirelessHART® are marks of the FieldComm Group of Austin, Texas, USA.

The Bluetooth® wordmark is a registered trademark owned by the Bluetooth SIG, Inc.

The Emerson logo is a trademark and service mark of Emerson Electric Co.

All other marks are the property of their respective owners.

### Notice

---

#### Important



Read this manual before working with the Trex unit. For personnel and system safety, and for optimum product performance, thoroughly understand the contents before using or servicing this product.

For equipment service needs, contact technical support.

---

#### Important

This device complies with Part 15 of the FCC Rules. Operation is subject to the following two conditions: (1) this device may not cause harmful interference, and (2) this device must accept any interference received, including interference that may cause undesired operation.

---

### **⚠ WARNING**

If the Trex unit is used in a manner not specified by Emerson, the protection provided by the equipment may be impaired.

---

### **⚠ WARNING**

Do not directly connect the ports or terminals on the Trex unit to any main line voltage.

---

### **⚠ WARNING**

**WARNING** - POTENTIAL ELECTROSTATIC CHARGING HAZARD - SEE INSTRUCTIONS.

**AVERTISSEMENT** - DANGER POTENTIEL DE CHARGES ÉLECTROSTATIQUES - VOIR INSTRUCTIONS

---

# Contents

Chapter 1	AMS Trex Device Communicator User Guide.....	5
Chapter 2	AMS Trex Device Communicator overview.....	9
Chapter 3	Field Communicator application.....	45
Chapter 4	Loop Diagnostics application.....	113
Chapter 5	Fieldbus Diagnostics application.....	141
Appendix A	Troubleshooting.....	169
Appendix B	Technical specifications.....	173
Appendix C	Approvals and Certifications.....	181
Glossary	.....	185
Index	.....	189



# 1 AMS Trex Device Communicator User Guide

## 1.1 User Guide overview

The *AMS Trex 2 Device Communicator User Guide* is written for instrument technicians who work with field devices, including HART<sup>®</sup>, FOUNDATION<sup>™</sup> fieldbus, and Bluetooth technology enabled devices. The user guide describes the hardware, connections to devices, the supported applications, and the diagnostics you can run on devices, 4-20 mA current loops, or FOUNDATION fieldbus segments.

### Note

The Trex unit has two communication module options. This user guide describes both modules. Any differences in the procedures based on these modules are noted.

## 1.2 Documentation conventions

The following conventions are used throughout:

### Note

A note paragraph contains special comments or instructions.

### ⚠ CAUTION

A caution paragraph alerts you to actions that can have a major impact on the equipment or stored data.

### ⚠ WARNING

A warning paragraph alerts you to actions that can have extremely serious consequences for equipment and/or personnel.



Read this manual before working with the Trex unit, and thoroughly understand the contents before use.



This symbol indicates general hazards or important instructions that must be observed to avoid personal injury or property damage.

## 1.3 Product support

Emerson provides a variety of ways to reach your Product Support team to get the answers you need when you need them:

**Phone** Toll free 800.833.8314 (U.S. and Canada)  
+1.512.832.3774 (Latin America)

+63.2 702.1111 (Asia Pacific, Europe, and Middle East)

**Email** [Guardian.GSC@Emerson.com](mailto:Guardian.GSC@Emerson.com)

**Web** <http://www.emerson.com/en-us/contact-us>

To view toll free numbers for specific countries, visit <http://www.emerson.com/technicalsupport>.

## 1.3.1 Information to provide to technical support

Before you call technical support, have a detailed description of the issue, including the information below (if applicable). Ensure you have the user manual for the devices or digital control system available.

### Information about the Trex unit

- Operating system version on the Trex unit. (Tap **Settings** → **About AMS Trex**.)
- The serial number of the Trex unit. The serial number is located on the label on the bottom of the Trex unit, near the power module LEDs. You can also view the serial number from the Settings. (Tap **Settings** → **About AMS Trex** → **Model**.)
- The version of the application. (Tap **Settings** → **Apps** → **Application**. Scroll to the bottom of the screen to view the version number.)

### Troubleshooting device communication issues

- Does the control system support HART® or FOUNDATION™ fieldbus communications?
- What is the manufacturer and model of the control system?
- What is the device manufacturer name (or ID) and model revision of the device (exact spelling if possible)?
- What task is being performed when the communication problem occurs?
- Can AMS Device Manager or another Trex unit communicate with the device?
- Are you having communication problems with multiple devices?
- Are there any error messages displayed when attempting to communicate with a device?
- Does communication work when certain devices or processes are not running?
- What is the total cable length run from the termination panel to the device?

When you are working with HART devices, answer the following questions:

- What is the loop impedance (resistance value) in the HART loop?
- If a HART multiplexer is being used, what is the manufacturer and model?
- Is the device in burst mode?
- Is the device address set to "0"?
- Is more than one device on the loop?
- Is another master (primary or secondary) on the loop? (For example, a control system or multiplexer.)

- Is the device powered by the Trex unit or an external power supply?

## 1.4 AMS Trex 2 known issues

The following list contains known issues in AMS Trex 2 Device Communicator. Some issues may be intermittent.

Issue ID	Description
224744	Hardkey navigation is not supported in the AMS Field Communicator, and AMS Device Configurator applications. Hardkey navigation will be supported with a future release.
707593	The AMS Trex 2 communication modules (Device Communication, Device Communication Plus) are not interchangeable with Trex 1. Trex 2 communication modules are only supported on the Trex 2 OS.
1524866	When the display size is set to it's maximum setting, the displayed values are truncated and parameters do not appear in the Fieldbus Diagnostics application.
14859758	The support contract and installed licenses are not viewable on the Trex unit, support contract and installed licenses can be viewed in Upgrade Studio.
15206435	Setting the display and font size too large causes the screen to distort and some applications and features to not appear. To make all applications and features visible, reset the display and font size in the Trex Settings.
15338112	When connecting or disconnecting the Trex 2 unit to Upgrade Studio using a USB connection, the device status icon does not update. To update the status of the Trex unit, click the Refresh button.
15672444	The Touchscreen Calibration application does not have an Exit button. You must complete the calibration to exit the application.
16103416	Upgrade Studio does not recognize the connected Trex unit. Disconnect and reconnect for Upgrade Studio to detect the Trex unit.
16216766	Special characters in a device configuration are not readable and will be skipped when renaming in the Configuration Management application.
19051139	The AMS Trex 2 Device Communicator Wi-Fi radio is temporarily disabled. Wi-Fi will be enabled with a future OS update. When the OS update is released users can update their Trex units via Upgrade Studio. The Wi-Fi toggle switch is visible.





## 2 AMS Trex Device Communicator overview

The Trex unit supports HART®, FOUNDATION™ fieldbus, and Bluetooth technology enabled devices, so you can configure or troubleshoot in the field or on the work bench. Electronic Device Description Language (EDDL) technology enables the Trex unit to communicate with a variety of devices independent of device manufacturer.

Depending on the attached communication module, the Trex unit lets you:

- Configure HART and FOUNDATION fieldbus devices.
- Power one HART or FOUNDATION fieldbus device.
- Measure current and view voltage.
- Perform diagnostics on a 4-20 mA current loop or FOUNDATION fieldbus segment.

The Trex unit includes a color LCD touchscreen, a Lithium-Ion power module (battery pack), a processor, memory components, and optional communication modules.

### **⚠ CAUTION**

When the Trex unit communicates with devices, follow all standards and procedures applicable to the location. Failure to comply may result in equipment damage and/or personal injury. Understand and comply with the sections in this manual.

## 2.1 Precautions for the Trex unit

Before operating the Trex unit, ensure:

- The Trex unit is not damaged.
- The power module is securely attached.
- All screws are sufficiently tightened.
- The communication terminal recess is free of dirt and debris.
- The communication module is securely attached.

### **⚠ CAUTION**

Do not use a screen protector on an IS-approved Trex unit. Static discharge is possible.

### 2.1.1 Hazardous areas

A Trex unit that meets the Intrinsic Safety requirements (IS-approved) can be used in Zone 1, or Zone 2, for Group IIC, and Class I, Division 1 and Division 2, Groups A, B, C, and D locations.

An IS-approved Trex unit may be connected to loops or segments that are attached to equipment located in Zone 0, Zone 1, Zone 2, for Group IIC; Zone 20, Zone 21, Zone 22, and Class I, Division 1 and Division 2, Groups A, B, C, and D locations.

An IS-approved Trex unit can be ordered by selecting the KL option. The Trex unit has a label that lists the approvals.

### **⚠ WARNING**

#### **Explosions can result in serious injury or death.**

Use in an explosive environment must be in accordance with the appropriate local, national, and international standards, codes, and practices. Please review the Technical specifications and Product certifications sections of the *AMS Trex Device Communicator User Guide* for any restrictions associated with safe use.

#### **Electrical shock can result in serious injury or death.**

## 2.2 Trex certification options

The Trex 2 Intrinsically Safe (IS) version (Trex2-abKLde) is approved for use in the certified hazardous areas.

The Trex 2 non IS version (Trex2-abNAde) is for use in non-hazardous areas.

See [Product certifications](#) for a list of current certifications for Trex 2.

Type designation: **Trex2-abcde** where:

**a = Communication Module** (specifies the installed devices according to IEC/EN 60079-11):

C = Trex 2 Device Communication

L = Trex 2 Device Communication Plus

D = Reserved for the complete Trex2 device assembly. For further details, see the marking on the communication module label.

0 = None

**b = Power Module Type:** (specifies the installed devices according to IEC/EN 60079-11):

P = Rechargeable Li-Ion Power Module Rev.04

0 = None

**c = Product Certification**

KL = ATEX, cCSA and CSAus, IECEx Intrinsically Safe (includes FISCO as applicable)

NA = None (Used for individual modules that are not Ex-certified as a stand-alone device, as well as for the use of the complete Trex2 device in non-hazardous areas)

**d = Radio Options**

W=Wi-fi and or Bluetooth for Trex2

9 = None for Trex2

M = Reserved for the complete TREX2 device assembly. For further details see the marking on the Display and CPU module label.

e = Options

\* = any alphanumeric or symbolic characters (not relevant for hazardous area certification)

## 2.3 Front view of the Trex unit

Figure 2-1: Front view



- A. Micro USB port (top)
- B. Power button (side)
- C. Strap connectors (side)
- D. Touchscreen
- E. Keypad
- F. Charger port for the AC adapter (side)

**Related information**

[LEDs on the power module](#)  
[Touchscreen](#)

## 2.3.1 Keypad

The Trex unit has a keypad that lets you navigate and select menu options. Use the four arrow buttons to move across all selectable options on the screen, and use the checkmark button to select an option.

The keypad also lets you enter text or numbers, based on the selected option or menu. An onscreen keyboard is displayed. The four arrows let you navigate to a letter, number, or symbol on the keyboard. Press the checkmark button or X button to select the option.

**Figure 2-2: Keypad**



- A. Cancel any unsaved changes or close a menu. Similar to a Back button.
- B. Move through the menus and icons in the applications. Press the up, down, right, and left arrow keys to highlight a menu option on a screen. The right and left arrow keys also select items in a grid or on a graph, but they do not let you navigate to the next level in a menu.
- C. Open a menu item or accept any updates. Similar to an Enter button.

## 2.4 Touchscreen

The Trex unit has a resistive touchscreen that lets you select menu items and enter text. Firmly press the screen to select an item. You need to apply more pressure than you would for smart phones and tablets. If the touchscreen seems inaccurate, you can re-calibrate it. All instructions in this manual are written for the touchscreen.

The touchscreen supports basic gestures, such as scroll up and scroll down. Multi-touch gestures, such as pinch, are not supported.

**⚠ CAUTION**

The touchscreen display on the Trex unit could be damaged if directly impacted. To avoid damaging the touchscreen:

- Use the Trex carrying case with the faceplate closed to protect the touchscreen and prevent any damage when transporting or carrying the Trex unit.
- Do not let the touchscreen come in contact with other objects.
- Contact the touchscreen with blunt items only. Sharp instruments, such as screwdrivers, can damage the touchscreen.

Repairing the touchscreen requires replacement of the entire display assembly, which is possible only at an authorized service center.

**⚠ CAUTION**

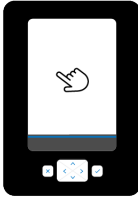
Do not use a screen protector on an IS-approved Trex unit. Static discharge is possible.

### 2.4.1 Supported gestures

The Trex unit uses a single-tap to select an item on the screen. You do not need to double-tap an option on the screen.

**Note**


Multi-touch gestures, such as pinch, are not supported. Only single-touch gestures are supported.

Gesture	Description
	<p>Tap.</p> <p>Tapping a menu item opens another menu. For example, you can tap a device description in the Field Communicator application and a menu is displayed.</p> <p>Press and hold.</p> <p>Some menu items have a context menu associated with them. Pressing and holding a menu item will activate the context menu. For example, pressing and holding on a menu in the Field Communicator application brings up a context menu that allows access to help, or adding the item as a favorite.</p>

Gesture	Description
	<p>Scroll down.</p>
	<p>Scroll up.</p>
	<p>Scroll right. Used to move right on graph or grid, or to view additional columns/data on a screen.</p>
	<p>Scroll left. Used to move left on graph or grid.</p>

## 2.4.2 Enter text, numbers, or special characters

If an option requires you to enter text, the application displays a keyboard with the permitted characters. You can enter letters, numbers, punctuation, and special characters. Tap the screen or use the four arrows keys on the keypad to enter the desired characters.

For screens that require passwords, text is hidden by default but can be revealed before confirming by tapping the reveal icon. 

### 2.4.3 Clean the touchscreen

Clean the touchscreen with a soft cloth with pH-neutral detergent or alcohol. When the touchscreen is contaminated by chemicals, immediately wipe them off with caution to avoid injury to the human body.

## 2.5 Back view of the Trex unit

You can access the communication module, the stand, and the power module.

**Figure 2-3: Back view**



- A. *Communication module*
- B. *Stand*
- C. *Power module*

### Related information

[Precautions for the communication module](#)

[Replace the stand](#)

[Power module](#)

### 2.5.1 Serial numbers

The Trex unit has a serial number for each part, including the main unit, power module, and communication module. The label on each part lists the serial number. You may need to provide a serial number if you work with technical support.

The serial number for the Trex unit is located on the label on the bottom of the unit, near the power module LEDs. You can also view the Trex unit serial number from the **Settings**. (Tap **Settings** → **About AMS Trex** → **Model**.)

## 2.6 Communication modules

The Trex unit has two communication modules.

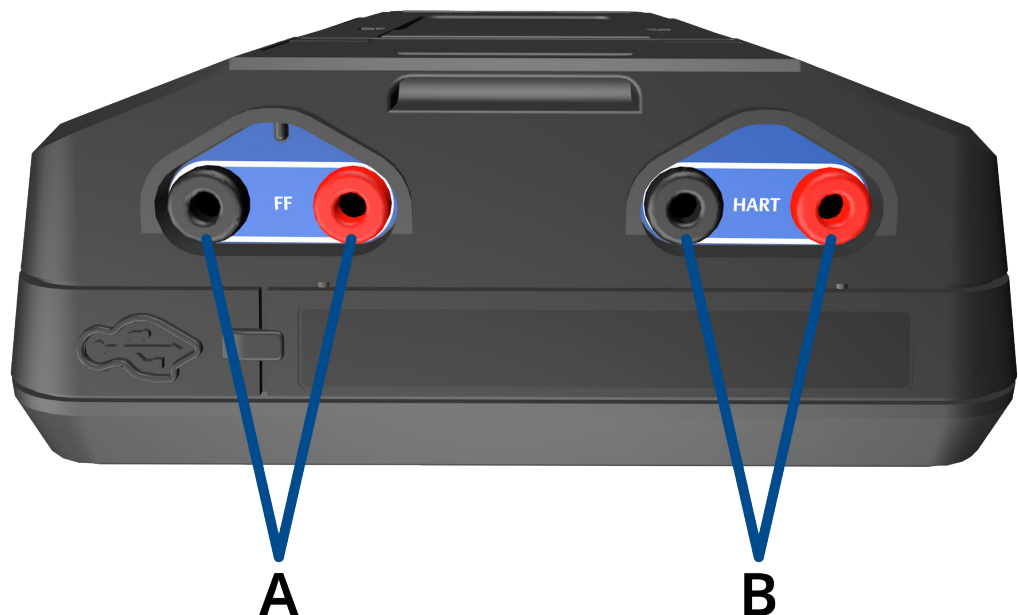
### Note

AMS Trex 2 Device Communication Modules are not interchangeable with Trex 1 Communication Modules.

### Device Communication Module

The Device Communication Module can connect to and communicate with HART and FOUNDATION fieldbus devices on an externally-powered HART loop or fieldbus segment. The Device Communication Module has unique terminals for both HART and FOUNDATION fieldbus devices.

**Figure 2-4: Device Communication Module**

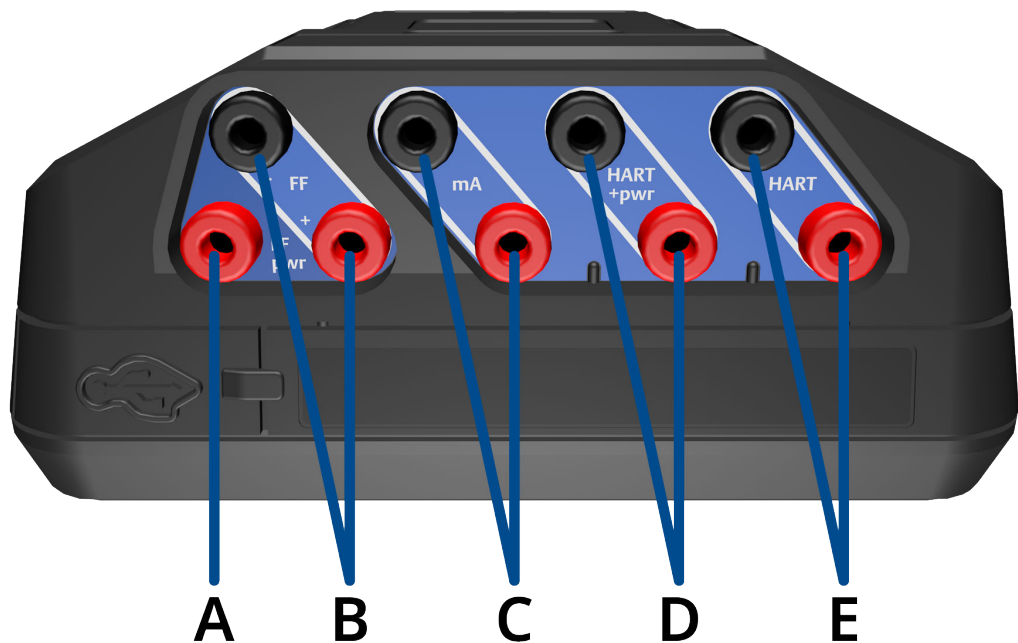


- A. Connect to externally-powered FOUNDATION fieldbus devices.
- B. Connect to externally-powered HART devices.

### Device Communication Plus Module

The Device Communication Plus Module can connect to HART and FOUNDATION fieldbus devices, measure current and voltage, and power a device.



**Figure 2-5: Device Communication Plus Module**

- A. Power a FOUNDATION fieldbus device. You need to connect the FOUNDATION fieldbus Power Plug to the FF pwr and the positive FF terminals.
- B. Connect to a FOUNDATION fieldbus device that is externally-powered or powered by the Trex unit.
- C. Measure current on a 4-20 mA current loop.
- D. Power and connect to a HART device. The HART+pwr terminals can measure the current output of a connected transmitter or control the current input to a connected positioner. The terminals also have a loop resistor for device communication.
- E. Connect to an externally-powered HART device. The HART terminals also have an optional loop resistor for enabling HART communications on 4-20 current loop and optional current control for moving a positioner.

### **⚠ CAUTION**

- Before you insert or remove a communication module, ensure the Trex unit is powered off.
- Ensure sufficient grounding. Ensure the personnel, working surfaces, and packaging are sufficiently grounded when handling electrostatically sensitive parts.
- Avoid touching the pins on the connectors or components. Discharged energy can affect the modules.
- When you insert/attach the communication module to the Trex unit, do not over tighten the screws. Use 0.5Nm maximum torque load.
- Remove the USB cable from the Trex unit before connecting to a device.

**⚠ WARNING**

- The Trex unit cannot power a 4-wire device. Do not connect Trex unit to the power terminals of a 4-wire device. This can blow a fuse inside the Trex unit. The repair/replacement will need to be completed at an authorized service center.
- Do not connect lead sets to the HART and HART + pwr terminals at the same time. If the lead sets are connected to devices, this increases the chance of wiring mistakes and could create a short in the HART loop.
- Do not add any external power to the device when the Trex unit is powering the device. This can blow a fuse inside the Trex unit. The repair/replacement will need to be completed at an authorized service center. Ensure the device is disconnected from the loop/segment and no other wires are connected to the device before providing power from the Trex unit.
- Do not use the Trex unit to power a *WirelessHART* device. Providing power to a *WirelessHART* device may damage the device.
- Do not connect the mA terminals (ammeter) in parallel with a powered 4-20 mA current loop. Ammeters have low resistance. This can disrupt the loop and cause devices to report incorrect values or positioners to move unexpectedly.
- Do not connect the mA terminals on the Trex unit to a power supply that is not current limited to 250 mA. This can blow a fuse inside the Trex unit. The repair/replacement will need to be completed at an authorized service center.

## 2.6.1 Ammeter on the Device Communication Plus module

The Device Communication Plus module has ammeters for reading current:

1. Ammeter in the mA terminals. This ammeter is intended for quick measurements and is for reference only.
2. Ammeter in the HART + pwr and HART terminals. This ammeter is used when the Trex unit is powering a transmitter, when the Trex unit is controlling current or is powering a positioner. This ammeter is intended for tasks including digital to analog trims, give feedback on the output current from the Trex unit, and is for reference only.

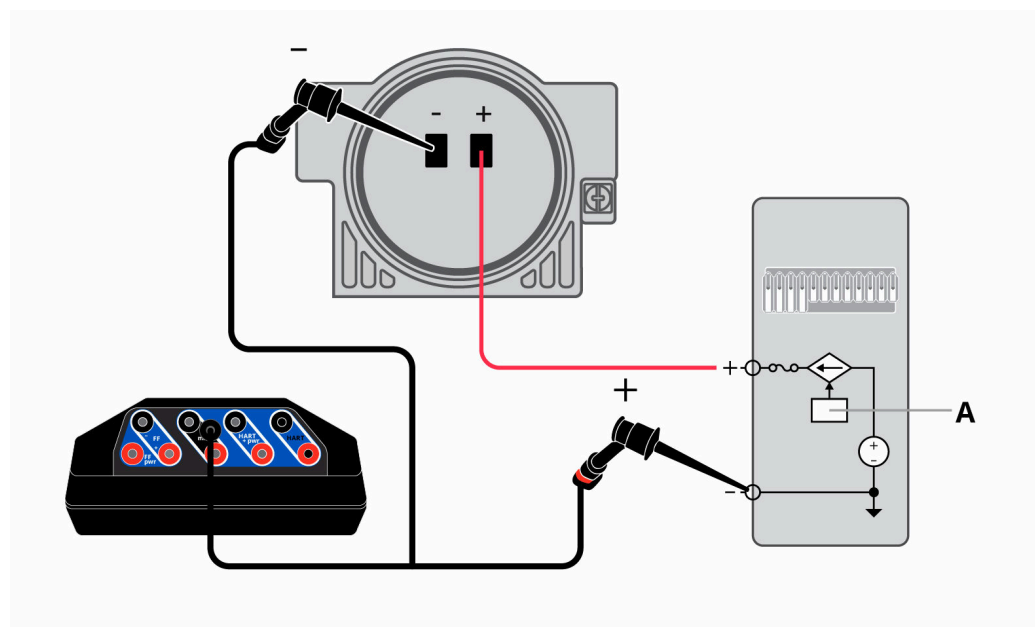
**⚠ WARNING**

- Do not use the HART + pwr and mA terminals in series when the Trex unit powers a device.
- Do not connect the mA terminals (ammeter) in parallel with a powered 4-20 mA current loop. Ammeters have low resistance. This can disrupt the loop and cause devices to report incorrect values or positioners to move unexpectedly.
- Do not connect the mA terminals (ammeter) in parallel with a powered 4-20 mA current loop. Ammeters have low resistance. This can disrupt the loop and cause devices to report incorrect values or positioners to move unexpectedly.
- Do not connect the mA terminals on the Trex unit to a power supply that is not current limited to 250 mA. This can blow a fuse inside the Trex unit. The repair/replacement will need to be completed at an authorized service center.

For best results when using the mA terminals, do the following:

- Avoid using the ammeter in cold or very hot temperatures. Extreme temperatures can affect the accuracy of the measurements.
- Connect the mA terminals on the Trex unit to the "low-side" of the device. See the example below.

**Figure 2-6: "Low-side" ammeter connection**



A. Analog output

## 2.6.2 Install a communication module

### ⚠ CAUTION

- Ensure sufficient grounding. Ensure the personnel, working surfaces, and packaging are sufficiently grounded when handling electrostatically sensitive parts.
- Avoid touching the pins on the connectors or components. Discharged energy can affect the modules.
- Handle the module with care. It is possible to bend the pins on the module's connector.

### Procedure

1. Turn off the Trex unit.
2. Place the Trex unit face down on a level, secure surface.
3. Place the communication module into the top of the Trex unit, and carefully align the communication module with the connector on the Trex unit.
4. Gently press the communication module until it is seated properly with the Trex unit.
5. Tighten the four screws using a screwdriver. Do not over tighten the screws. Use 0.5Nm maximum torque load.

## 2.6.3 Remove a communication module

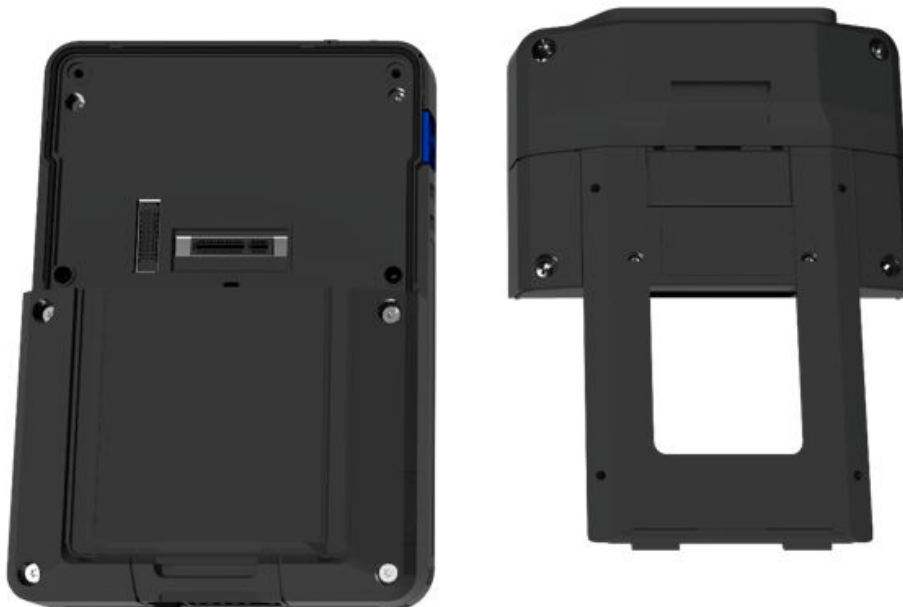
### ⚠ CAUTION

- Ensure sufficient grounding. Ensure the personnel, working surfaces, and packaging are sufficiently grounded when handling electrostatically sensitive parts.
- Avoid touching the pins on the connectors or components. Discharged energy can affect the modules.
- Handle the module with care. It is possible to bend the pins on the module's connector.

### Procedure

1. Turn off the Trex unit.
2. Place the Trex unit face down on a level, secure surface.
3. Remove any connected lead sets.
4. Loosen the four screws on the module using a screwdriver.
5. Gently lift the communication module straight away from the Trex unit. Do not slide the communication module.

Figure 2-7: Trex unit with the communication module removed



## 2.7 Power module

A rechargeable Lithium-Ion power module powers the Trex unit. A typical charge should last for more than 8 hours of continuous use. The Trex unit displays a low-battery warning when the remaining charge reaches a set level. Ensure you save any unsent data for a device before the power module reaches a low level.

You do not need to discharge or calibrate the power module. Contact technical support if you experience any problems with the power module.

### **⚠ WARNING**

Do not install, remove, or charge the Lithium Ion (Li-Ion) power module in a hazardous area environment.

### 2.7.1 Precautions for the power module and AC adapter

Understand and follow the precautions below before using the power module or AC adapter.

- When transporting a Lithium-Ion power module, follow all applicable regulations.
- Ensure sufficient grounding. Ensure the personnel, working surfaces, and packaging are sufficiently grounded when handling electrostatically sensitive parts.
- Avoid touching the pins on the connectors or components. Discharged energy can affect the power modules.

- Protect the power module and AC adapter from moisture, and respect operating and storage temperature limits listed in the *AMS Trex Device Communicator User Guide*. The AC adapter is for indoor use only.
- Do not cover the power module or AC adapter while charging. Do not subject them to prolonged periods of direct sunlight, or place them on or next to heat-sensitive materials.
- Charge the power module with only the provided AC adapter. The AC adapter should not be used with other products. Failure to comply may permanently damage the Trex unit and void the IS approval and warranty.
- Do not open or modify the power module or AC adapter. There are no user-serviceable components or safety elements inside. Opening or modifying them will void the warranty and could cause personal harm.
- Clean the AC adapter by clearing the terminal of dirt and debris, if required.
- If the AC adapter is used in a manner not specified by Emerson, the protection provided by the equipment may be impaired.
- The AC adapter comes complete with interchangeable plug heads for UK, USA, EU and AU.
- The maximum operating altitude for the AC adapter is 2000 meters.

#### **⚠ WARNING**

Do not use the AC adapter in a hazardous area environment.

## 2.7.2 AC adapter

The Trex unit includes an AC adapter for recharging the power module. The Trex unit is fully operational while the AC adapter charges the power module.

#### **⚠ WARNING**

Do not install, remove, or charge the Lithium Ion (Li-Ion) power module in a hazardous area environment.

#### **Related information**

[Precautions for the power module and AC adapter](#)

## 2.7.3 LEDs on the power module

The power module has six LEDs to indicate the charging status. Press the button next to the LEDs to illuminate the LEDs and view the current charge level.

**Figure 2-8: LEDs showing approximately 100 percent charge**

- A. AC adapter LED. Lights up when the AC adapter is attached to the power module. A green light indicates the power module is fully charged. An orange light indicates the power module is charging. No LED indicates the power module is not being charged.
- B. Power module LEDs. Each solid green LED indicates approximately 20 percent charge. A blinking LED indicates the power module is charging within that 20 percent range.
- C. Power module button. Press to illuminate the power module LEDs.

## 2.7.4

### View the remaining power module charge

You can check the remaining power module charge from several places.

#### Procedure

1. Check the charge from the power module.
  - a) Press the power module button to illuminate the 5 LEDs.
  - b) View the LEDs. Each solid green LED indicates approximately 20 percent charge.
2. Check the charge from the Trex **Home** screen.
  - a) Tap **Settings** → **Battery**.  
The charge level is displayed.

#### Related information

[LEDs on the power module](#)

Status bar

## 2.7.5 Charge the power module

Fully charge the power module before using it in the field. The Trex unit is fully operable when the power module is charging. An overcharge condition will not occur if the AC adapter is connected after charging completes. You can charge the power module when it is attached to or detached from the Trex unit.

To maintain performance, charge the power module frequently, preferably after each use. Limit full discharges, if possible.

If you experience communication issues when working with a device, remove the AC adapter from the Trex unit.

### **⚠ WARNING**

Do not install, remove, or charge the Lithium Ion (Li-Ion) power module in a hazardous area environment.

#### **Procedure**

1. Plug the AC adapter into a power outlet.
2. Attach the AC adapter cable to the charger port on the lower left side of the Trex unit.  
A full charge takes approximately three to four hours.

## 2.7.6 Install the power module into the Trex unit

### **⚠ CAUTION**

- Ensure sufficient grounding. Ensure the personnel, working surfaces, and packaging are sufficiently grounded when handling electrostatically sensitive parts.
- Avoid touching the pins on the connectors or components. Discharged energy can affect the modules.

### **⚠ WARNING**

Do not install, remove, or charge the Lithium Ion (Li-Ion) power module in a hazardous area environment.

#### **Procedure**

1. Place the Trex unit face down on a level, secure surface.
2. Align the power module with both sides of the Trex unit, and carefully place the power module onto the Trex unit.
3. Insert and tighten the four screws with a Torx® screwdriver to secure the power module. Do not over tighten the screws. Use 0.5Nm maximum torque load.



## 2.7.7 Remove the power module from the Trex unit

### ⚠ CAUTION

- Ensure sufficient grounding. Ensure the personnel, working surfaces, and packaging are sufficiently grounded when handling electrostatically sensitive parts.
- Avoid touching the pins on the connectors or components. Discharged energy can affect the modules.

### ⚠ WARNING

Do not install, remove, or charge the Lithium Ion (Li-Ion) power module in a hazardous area environment.

#### Procedure

1. Turn off the Trex unit.
2. Place the Trex unit face down on a level, secure surface.
3. Use a Torx® screwdriver to loosen the four screws on the power module. The screws do not need to be fully removed.
4. Gently lift the power module straight away from the Trex unit. Do not slide the power module.

**Figure 2-9: Trex unit with the power module removed**



## 2.7.8 Maintain the power module

To help maintain the performance and life of the power module, understand and follow the guidelines below:

- Recharge the power module frequently, preferably after each use or at night. Limit the number of full discharges, if possible.
- Avoid frequent use at high temperatures because this can reduce performance.
- Use a dry location at or near room temperature when storing the power module for an extended time. Prolonged storage at higher temperatures can reduce performance.
- Ensure the remaining charge level is at or near mid-capacity when storing for an extended time. The remaining charge will slowly drain during storage. Periodically charge the power module to ensure the remaining charge does not drain to low levels.

## 2.8 Accessories

The Trex unit includes the following accessories:

- Lead set.
- A FOUNDATION fieldbus Power Plug to enable the Trex unit to power a FOUNDATION fieldbus device.
- A USB cable to connect the Trex unit to PC applications.
- AC adapter.
- A handstrap that can be connected to either side of the Trex unit.

### 2.8.1 Cables and lead sets

The Trex unit comes with a lead set so it can connect to a device. The lead set attaches to one set of terminals on the top of the Trex unit. The positive lead is marked with a red band near the banana jacks.

---

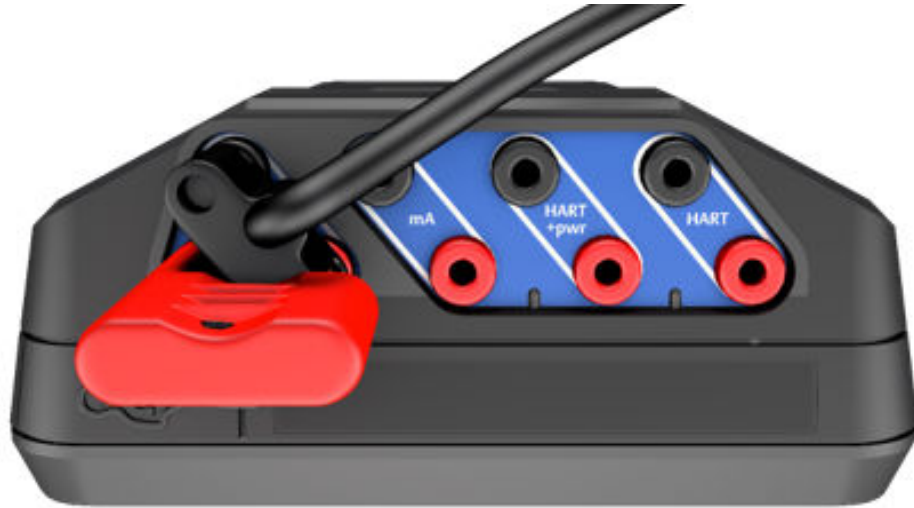
#### Note

When you remove the lead set from the Trex unit, do not pull on the cable. Grab the plug/connectors and remove the lead set from the terminals.

---

The Trex unit may also include a FOUNDATION fieldbus Power Plug, which is used to power one FOUNDATION fieldbus device. Use the FOUNDATION fieldbus Power Plug with the Device Communication Plus Module. The plug attaches to the FF pwr terminal and the positive FF terminal on top of the lead set.

**Figure 2-10: FOUNDATION fieldbus Power Plug attached to the Trex unit**



## 2.8.2 Carrying case for the Trex unit

A carrying case is available to hold the Trex unit and store lead sets, the AC adapter, and other accessories. The case has several compartments and a shoulder strap.

When transporting or carrying the Trex unit in the case, ensure the face plate on the case is closed. This protects the touchscreen from unexpected contact with other objects.

### **Note**

Ensure the carrying case is clean. Otherwise, this can affect the strength of the connection on the strap or faceplate. When carrying the Trex unit in high places, use the hand strap.

The bottom compartment on the carrying case opens so you can store the AC adapter with the Trex unit.

**Figure 2-11: The carrying case**



## 2.9 Power on or off

### Procedure

1. To power on, press and hold the power button on the upper left side of the Trex unit.
2. To power off, quickly press the power button and tap **Power off**.

### 2.9.1 Restart

#### Procedure

To restart the Trex, quickly press the power button and tap **Restart**.

### 2.9.2 Hard shut down

If the Trex unit is unresponsive, do a hard shut down and then power the Trex unit. Do not use this as your normal shut down method. Contact technical support if you need to repeatedly force a shut down.

#### Procedure

Press and hold the power button for 10-20 seconds until the Trex unit shuts down.

## 2.10 Home screen

The Home screen appears after you power the Trex unit. The Home screen displays the installed applications, the status bar at the top of the screen and the navigation bar at the bottom of the screen. The Home screen may display one or more of the applications listed below.

**Figure 2-12: Home screen**

Application	Description
Field Communicator	Connect to and configure HART or FOUNDATION fieldbus devices. The Trex unit can also power one HART or FOUNDATION fieldbus device.
Fieldbus Diagnostics	Measure the DC voltage, the noise, and the signal on a FOUNDATION fieldbus segment. The Trex unit can also power one FOUNDATION fieldbus device.
Loop Diagnostics	Measure loop current, control current, and power a HART device when using a Trex unit with a Device Communication Plus module.
Settings	View and adjust settings for the Trex unit.
Trex Help	View help topics that describe the hardware and applications on the Trex unit.
WirelessHART Provisioning	Quickly provision connected WirelessHART devices to a Smart Wireless Gateway.
AMS Device Configurator	Connect to, configure and troubleshoot Emerson's field instrumentation with Bluetooth® technology.
Trex Calculator	Calculate standard and enhanced operations in loop and unit conversion, and Ohm's law calculations.
PDF viewer	Download and display PDF files using File Transfer Utility.

### Related information

[Status bar](#)

### 2.10.1 Return to the Home screen

If an application is open, you can return to the home screen without exiting the application.

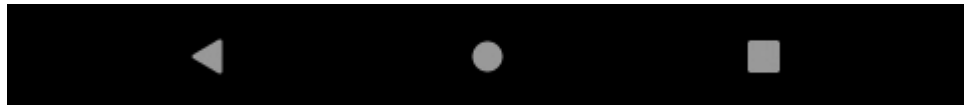
#### Procedure

Tap the circle button on the navigation bar to return to the home screen.




### 2.10.2 Navigation bar

Use the buttons along the bottom of the screen for quick navigation between Trex applications.

**Figure 2-13: Navigation bar**



### Navigation buttons

Icon	Meaning
	Back: Goes back to the previous screen.
	Home: Takes you to the Home screen.
	Recents: Displays recently opened apps.

## 2.10.3 Status bar

The status bar is located at the top of the screen and displays system information. The status bar is displayed on the Home screen and in applications.

The status bar displays the following:

- Time
- Bluetooth icon
- USB icon
- Battery level

## 2.11 Settings

The Settings application lets you view information about the Trex unit hardware and modify settings for the Trex unit. To view and modify settings, tap **Settings** on the Home screen. You can set the following:

- Screen brightness
- Wi-Fi connection
- Connect Trex to Emerson devices with Bluetooth wireless technology
- A name for the Trex unit
- Touchscreen calibration
- Date and Time
- Language preference
- Power management options
- Trex Security

## 2.11.1 View all open applications

You can have multiple applications open at one time. However, some applications may not be able to run simultaneously because they use the same Trex hardware. (An error message is displayed when this occurs.)

### Procedure

From the Home screen, tap the Recents button on the navigation bar. All open applications will be listed.


- To open, tap the application.
- To view more, swipe to the left or right.
- To close an application, swipe up.
- To close all applications, tap Clear all.

## 2.11.2 Close an application

There are multiple ways to close an application.

### Using the application menu

To close an app using the application menu:

1. Tap the application menu  and select **Exit**.

### Using the Recent apps list

To close using the Recent apps list:

1. Tap the Recents button.
2. Scroll left or right to find the app you want to close.
3. Swipe the app up and off the screen to close.

### Force stopping an app

Force closing an app can help resolve issues such as app crashes, freezing, or performance problems. This process stops the app and its background processes completely.

### Procedure

1. Tap **Settings**.
2. Scroll down and tap **Apps**.
3. Tap the app you want to close.
4. Tap **Force stop** and confirm.

## 2.11.3 Change the screen brightness

### Procedure

1. Tap **Settings** → **Display** → **Brightness level**.

2. Use the slider to change the brightness.

## 2.11.4 Set display size and text


To make your display and font size smaller or larger:

### Note

Setting the font or display too large will cause the display to distort and make applications inaccessible.

1. Tap **Settings** → **Display** → **Display size and text**.
2. To change your preferred font size, move the slider left or right.
3. To change your preferred display size, move the slider left or right.
4. To reset your settings, tap **Reset Settings**. Your display size and text preferences will reset to the original setting of the Trex unit.

## 2.11.5 Enable Bluetooth® wireless technology

You can enable or disable Bluetooth technology at any time. When Bluetooth is turned on, the Bluetooth icon  displays in the status bar.

The fastest way to enable Bluetooth technology is by using the Quick Settings menu. Swipe downward from the status bar to open the Quick Settings. Once the menu appears, tap the **Bluetooth** button.

You can also turn on Bluetooth in the Trex Settings. Tap **Settings** → **Connected devices** → **Connection preferences** → **Bluetooth** and toggle the **Use Bluetooth** switch to on.

## 2.11.6 View information about the Trex hardware and operating system

You can view the information about the Trex unit, including the name, serial number, operating system, third-party licenses, and the MAC address.

### Procedure

Tap **Settings** → **About AMS Trex**.

## 2.11.7 Enter a name for the Trex unit

You can enter a name to uniquely identify the Trex unit. This is helpful if you have multiple Trex units at your site. By default, the Trex unit is named "TrexXXXXXXXXXXXX" where the Xs are the serial number. This name is displayed in Upgrade Studio and AMS Device Manager.

### Procedure

1. Tap **Settings** → **About AMS Trex**.
2. Tap **Device name**.



3. Enter a new name up to 20 characters.
4. Tap OK.

## 2.11.8 View the application version number

You can view the version numbers for the installed applications.

### Procedure

1. Tap **Settings** → **Apps** .
2. Tap the app you want to view the version.
3. Scroll to the bottom of the page to view the version information.

## 2.11.9 Set the time and date

### Note

When you connect the Trex unit to a PC or a wireless network, the Trex unit updates to use the same time as the PC or wireless network.

### Procedure

1. Tap **Settings** → **System** → **Date & time**.
2. Disable automatic time and date.
3. Edit the following options as needed.

Option	Description
Date	Set the date.
Time	Set the time.
Time Zone	Select region and time zone
Time Format	Select the locale or 24 hour format.

## 2.11.10 Calibrate the touchscreen

If the touchscreen seems inaccurate, you can recalibrate it.

### Note

If your Trex unit is unresponsive to the touch screen, you can press and hold the x button and checkmark button at the same time to initiate the calibration.

### Procedure

1. Tap **Touchscreen Calibration**.
2. Tap **Start calibration**.
3. Tap the screen as indicated.



## 2.11.11 Set the system language

### Procedure

1. Tap **Settings** → **System** → **Languages** → **System Languages**.
2. To add a language, scroll down to the bottom of the page and tap **Add a language**.
3. Once the language is added, press and hold the two horizontal lines and move your preferred language to the top.
4. If you already have multiple languages listed, press and hold the two horizontal lines to rearrange the languages to set your preferred one as the primary language.
5. After selecting or adding your preferred language, confirm the changes (if prompted). The Trex unit will process the new selection and update the user interface accordingly.

## 2.11.12 View available storage

### Procedure

Tap **Settings** → **Storage**.

## 2.11.13 View battery life

1. Tap **Settings** → **Battery**. Remaining battery percentage is displayed.
2. To display battery life percent in the status bar toggle battery percentage on.

## 2.11.14 Power management

You can configure options to maximize power usage.

Power management option	Description
Screen timeout	Power off the screen after a period of inactivity.
Shutdown timeout	Shut down the Trex unit after a period of inactivity.

When the AC adapter is connected to the power module, all the timers are disabled. It is recommended to connect your Trex unit to the AC Adapter when not in use to ensure full charge of the power module and maximize the life of the battery.

### Note

The timers are cumulative. For example, if you set the Screen timeout duration to 5 minutes, and the Shutdown timeout duration to 10 minutes, the Trex unit shuts down after 15 minutes of inactivity.

## Set the screen timeout

To conserve power, use the screen timeout setting to automatically turn off the display after a period of inactivity.

Screen timeout is enabled only when the AC adapter is not connected to the Trex unit.

**Procedure**

1. Tap **Settings** → **Display** → **Screen timeout**.
2. Select the duration of time before the display screen powers off when idle.  
Once you tap your selection, it will take effect immediately.
3. Tap the back arrow, or use the navigation bar to return to the Home screen.

**Set the shutdown timeout**

To conserve power, set the shut down timer to automatically shut down the Trex unit after a period of inactivity, such as no key presses or taps on the screen.

Shutdown timeout is enabled only when the AC adapter is not connected to the Trex unit.

**Procedure**

1. Tap **Settings** → **Battery** → **Shutdown timeout**.
2. Select the duration of time.  
Once you tap your selection, it will take effect immediately.

## 2.11.15 Set background wallpaper

1. Open the Trex Settings and tap **Wallpaper**.
2. Tap **Wallpapers**. Wallpaper options are displayed at the bottom of the screen.
3. Tap on the wallpaper to select it.
4. Tap the Set wallpaper checkmark.
5. Select whether you want to set the wallpaper to the Home screen, Lock screen, or the Home screen and lock screen.

## 2.11.16 AMS Trex security

You can set a screen lock to secure your Trex unit from unauthorized access. Each time you turn on your unit or wake up the screen you will be prompted to unlock the Trex with a pin, or password.

**Set a screen lock**

You can set a screen lock to secure access to your Trex unit.

**Screen lock options**

- None: Trex stays unlocked
- Swipe: Swipe your finger across the screen.
- PIN: Enter 4 or more numbers.
- Password: Enter 4 or more letters or numbers.

**Procedure**

1. Tap **Settings** → **Security & privacy**.

2. Tap **Set screen lock**.
3. Tap the screen lock option you want to use.
4. Follow the on-screen instructions.

## Disable screen lock

### Procedure

1. Open the Trex Settings app.
2. Tap **Security & privacy** → **Device unlock** → **Screen lock**.
3. If you have previously set a lock, enter your pin or password.
4. To remove your screen lock, tap **None**.

## 2.11.17 Enable or disable automatically connecting to HART devices

If this option is enabled, the Field Communicator application searches for and automatically connects to an externally-powered HART device at address zero and displays its device menu. This makes the connection process faster. If this option is disabled, the Field Communicator application polls addresses zero and 63 and displays the Device List, so you can select a device from the list or change polling options from the **My Device Not Found** button.

You may want to disable this option in the following situations:

- The Trex unit is connected to a multi-drop HART loop, and you want to configure a device at another address.
- The Trex unit is connected to a transmitter at address zero with a THUM adapter. Otherwise, the Trex unit may automatically connect to the transmitter at address zero, and would not allow you to connect to the THUM adapter.
- You want to configure multiple THUM adapters and do not want to adjust the polling option.


### Procedure

1. In the Field Communicator application tap the application menu and select **Settings**.
2. Toggle the Auto Connect switch to enable or disable the option.

## 2.11.18 Enable Diagnostic Logging

### Procedure

1. **Note**  
You should only enable Diagnostic Logging when directed by Emerson service personnel.

In the Field Communicator application tap the application menu  and select **Settings**.

2. Toggle the Enable Diagnostic Logging switch to ON.

## 2.12 Applications on the Trex unit

The Home screen displays all the applications installed on the Trex unit. Open applications by tapping the application icon.

Field Communicator, Settings, and Trex Help applications do not require activation to work. Other applications on the Trex unit may be disabled until you activate the Trex unit. You can use Upgrade Studio to activate your Trex unit. Other applications may be disabled because you did not purchase a license for the functionality, or the Trex unit does not have the required communication module.

You can run some applications simultaneously on the Trex unit, while other applications may require the same hardware and cannot run at the same time. An error message is displayed on the screen when that occurs. Applications, such as the **Field Communicator** application and **Settings**, can run simultaneously. To switch between applications that can run simultaneously, tap the recents button on the navigation bar. You can then select the open application you want to view and use.

You can purchase new applications or get updates to applications from Upgrade Studio. See the Upgrade Studio Help for more information.

### Related information

[Home screen](#)

[View the application version number](#)

### 2.12.1 Activation

After you receive the Trex unit, activate it using Upgrade Studio. Activation allows you to download and install updated content on the Trex unit, as well as access to additional applications. Some applications may require you to purchase a license.

A reminder message is displayed each time you power on the Trex unit until activation is completed.

### 2.12.2 Using the application drawer

The application drawer is a list of all the apps installed on your Trex unit. All applications are displayed as icons and can be directly launched by tapping the icon. To open the app drawer, swipe up from the bottom of the Home screen.


To quickly find an app, tap the search bar and type the name of the app. The app drawer filters the results in real-time as you type.

### 2.12.3 Close an application

There are multiple ways to close an application.

### Using the application menu

To close an app using the application menu:

1. Tap the application menu  and select **Exit**.

### Using the Recent apps list

To close using the Recent apps list:

1. Tap the Recents button.
2. Scroll left or right to find the app you want to close.
3. Swipe the app up and off the screen to close.

### Force stopping an app

Force closing an app can help resolve issues such as app crashes, freezing, or performance problems. This process stops the app and its background processes completely.

#### Procedure

1. Tap **Settings**.
2. Scroll down and tap **Apps**.
3. Tap the app you want to close.
4. Tap **Force stop** and confirm.

## 2.13 USB communication

The Trex unit supports USB communication with PCs. The Trex unit has a micro USB port on the top left corner of the unit. The required USB driver is automatically installed with Upgrade Studio and AMS Device Manager. You can:

- transfer files to the Trex unit, using Upgrade Studio
- pair the Trex unit with an AMS Device Manager system to synchronize data

#### Note

AMS AutoSync is currently not supported on the Trex 2 platform. Support will be included in a future release.

To help ensure proper communication between the Trex unit and the PC, do not use a USB 2.0 cable that is longer than 2 meters. Do not connect more than one Trex unit to an AMS Device Manager station at one time.

#### CAUTION

- Remove the USB cable from the Trex unit before connecting to a device.
- Do not use USB communication in a hazardous area.

## 2.14 Upgrade Studio

Upgrade Studio is a PC application that lets you update the Trex units at your site with new/updated device descriptions, applications, and operating systems. You can download the updates to Upgrade Studio, or you can import the updates into Upgrade Studio from a network, or local drive. (You can use Upgrade Studio with or without an internet connection.)

After the updates are downloaded or imported into Upgrade Studio, you can transfer and install the updates onto the connected Trex unit.

Upgrade Studio also provides a link to MyEmerson. MyEmerson is a personalized website that provides access to Emerson sales, services and product support.

Upgrade Studio lets you:

- Create and use your Trex online user account to activate the Trex unit, download updates, view support contract information, or access MyEmerson.
- Activate the Trex unit. (Activation is required to install updates and access additional features.)
- Download new or updated device descriptions, applications, and operating systems for the Trex unit.
- Import new or updated device descriptions, applications, PDF files, and operating systems for the Trex unit into Upgrade Studio. Use the Import option if the PC does not have an internet connection and cannot download updates. (You can also import Trex synchronization files or updates to Upgrade Studio.)
- Transfer and install the updates onto the Trex unit.
- Download and install a newer version of Upgrade Studio.
- View the files that are installed on the Trex unit and additional information about the Trex unit.

To install Upgrade Studio, visit the [support page](#) to download the software.

### 2.14.1 Connect the Trex unit to Upgrade Studio using USB

#### Prerequisites

#### **⚠ CAUTION**

- Remove the USB cable from the Trex unit before connecting to a device.
- Do not use USB communication in a hazardous area.
- Upgrade Studio cannot connect to multiple Trex units at one time. Only one connection via USB is supported.
- To help ensure proper communication between the Trex unit and the PC, do not use a USB 2.0 cable that is longer than 2 meters.

### Procedure

1. Ensure the Trex unit is powered on.
2. Connect the microUSB cable to the top of the Trex unit, and then to the PC where Upgrade Studio is installed.


---

#### Note

The USB driver is installed when you install Upgrade Studio.

---

3. In Upgrade Studio, click **Activate Units** or **Install Updates**.
4. If you do not see the Trex unit, select **Show All Trex units** from the drop-down bar.

Upgrade Studio connects to the Trex unit and the  icon appears on the screen.

## 2.14.2 Create a Trex online user account

Upgrade Studio provides a link to a website to create a user account. You need a user account to:

- Activate the Trex unit. (A user account is needed for activation when Upgrade Studio has an internet connection.)
- Download updates for the Trex unit or Upgrade Studio.
- View the support contract information for the Trex unit.
- Access MyEmerson (Shop Emerson). MyEmerson is a personalized digital tool that provides access to Emerson sales, services and product information.

### Procedure

1. In Upgrade Studio, click **Login** → **Create an Account**.  
A web browser opens.
2. Enter your information.
3. Click **Request Account**.
4. Wait for notification via email that the user account is available.
5. Follow any additional steps described in the notification email.

## 2.14.3 Activate the Trex unit

### Prerequisites

Create a user account in Upgrade Studio.

The Trex unit displays an activation reminder message each time you power on the Trex unit until it is activated. Activation enables the full functionality on the Trex unit and associates the Trex unit with your user account/company.

Upgrade Studio can activate the Trex unit with or without an internet connection. The procedure below is for PCs with an internet connection.



### Procedure

1. Connect the Trex unit to the PC where Upgrade Studio is installed.
2. In Upgrade Studio, click **Activate Units**.
3. Click **Login**.
4. Enter your username and password, if prompted, and click **Login**.  
Logging in enables Upgrade Studio to retrieve the correct activation code for the Trex unit. If you do not log in, you need to click the "Don't have an activation code?" link to request an activation code. When you receive the activation code, enter or copy/paste the code onto the Activate Units screen.
5. Click the Trex unit displayed on the left side of the screen.
6. Click **Activate**.  
A message confirming the activation was successful is displayed.

## 2.14.4 Activate the Trex unit without using an internet connection

### Prerequisites

To activate the Trex unit without using an internet connection, request an activation code by emailing Emerson at [WWCS.CustServ@emerson.com](mailto:WWCS.CustServ@emerson.com) or calling 888-367-3774 option 2 (U.S. and Canada) or +63.2.702.1111 (worldwide) and providing the serial number. The serial number is located on the bottom of the Trex unit, but you can also access the serial number by connecting the Trex unit to Upgrade Studio and then hovering the cursor over the Trex unit icon.

### Procedure

1. Connect the Trex unit to the PC where Upgrade Studio is installed.
2. In Upgrade Studio, click **Activate Units**.
3. Click the connected Trex unit that is displayed on the left side of the screen.
4. Enter or copy/paste the activation code you received.
5. Click **Activate**.  
A message confirms the activation was successful.
6. Click **More** → **Export**.
7. Under **Trex Synchronization Files**, click **Show Details**.
8. Select one or more Trex synchronization files to export.
9. Click **Export**.
10. Select a location to save the Trex synchronization file, and click **OK**.
11. If you are not using the air-gap deployment, email the exported Trex synchronization file to Emerson at [WWCS.CustServ@emerson.com](mailto:WWCS.CustServ@emerson.com).
12. If you are using the air-gap deployment, do the following:
  - a) Open Upgrade Studio on the PC that has an internet connection.
  - b) Transfer the Trex synchronization file to that PC.
  - c) Click **More** → **Import Package**.

- d) Browse to the location that has the Trex synchronization file, and click **OK**.
- e) Click **Import**.
- f) Click **OK**.
- g) Log in with your username and password. Upgrade Studio uploads the Trex synchronization file.

## 2.15 Transferring files to a PC

Upgrade Studio lets you transfer logging or other files to a PC. Use the USB cable to connect the Trex unit to the PC where Upgrade Studio is installed. See the Help included with Upgrade Studio for more information.

## 2.16 Maintenance and repair

Any maintenance, repair, or replacement of components not listed below must be performed by specially trained personnel at an authorized service center. You can perform common maintenance procedures listed below:

- Clean the exterior. Use only a dry, lint-free towel or dampen the towel with an alcohol or mild soap and water solution.
- Clean the touchscreen.
- Install, remove, or charge the power module.
- Remove and replace the stand.
- Ensure that all exterior screws are sufficiently tightened.
- Ensure the communication terminal recess is free of dirt and debris.
- Install and remove the communication module.

### 2.16.1 Replace the stand

#### Procedure

1. Place the Trex unit face down on a level, secure surface.
2. Lift up the stand.
3. Use a Torx® screwdriver to loosen and remove the two screws under the stand.
4. Remove the stand.
5. Place the new stand on the Trex unit.
6. Insert and tighten the two screws. Do not over tighten the screws. Use 0.5Nm maximum torque load.

### 2.16.2 Calibration

Each AMS Trex unit with the Device Communication Plus Module is factory calibrated in accordance to the National Institute of Standards and Technology (NIST) standards.

To purchase NIST Certification contact the Trex Service Center  
WWCS.CustServ@Emerson.com.



## 3 Field Communicator application

The Field Communicator application lets you configure HART and FOUNDATION fieldbus devices. (The fieldbus functionality requires a license.) You can do the following:

- Power and connect to a HART transmitter, the Device Communication Plus Module is required. The Trex unit has an internal resistor, so you do not need to add a loop resistor.
- Power and connect to a HART positioner, the Device Communication Plus Module is required.
- Power and connect to the Smart Wireless THUM™ Adapter, the Device Communication Plus Module is required.
- Power and connect to a FOUNDATION fieldbus device, the Device Communication Plus Module is required. The Trex unit provides power, power conditioning, and two terminators.
- Connect to an externally-powered HART or FOUNDATION fieldbus device.
- Use the internal resistors in the Trex unit when connecting to an externally-powered HART transmitter. The internal resistors in the Trex unit temporarily convert an externally-powered 4-20 mA current loop into a HART loop.
- Save menu items from HART devices to a list of favorites for quick access.
- Simulate a HART or FOUNDATION fieldbus device.

---



### Note

The Field Communicator application can be used with the Device Communication Module or Device Communication Plus Module. However, the Trex unit cannot power a HART or FOUNDATION fieldbus device with the Device Communication Module.

---

### 3.1 Open or close the Field Communicator application

#### Procedure

1. To open the application, tap the **Field Communicator** icon  on the Trex **Home** screen.  
The **Auto-Detect** screen is displayed while the Field Communicator application tries to detect a connected device.
2. To close Field Communicator, tap the application menu  and tap **Exit**.

## 3.2 Device interoperability

The Trex unit communicates with many HART and FOUNDATION fieldbus devices independent of device manufacturer by using Electronic Device Description Language (EDDL) technology.

Basic testing is performed on all device descriptions. New device descriptions are available from the Upgrade Studio application.

## 3.3 Forward Compatibility rules for saving and sending configurations to AMS Trex

---

### Note

Do not edit configurations on the AMS Trex unit while connected to Configuration Management.

---

You can edit offline configurations on the Trex unit according to forward compatibility rules:

- To edit a configuration with Trex, you must have the proper device description installed on Trex. The installed device description must match the device type and device revision of the configuration. If the configuration does not exactly match the device description on the Trex unit, you cannot save the configuration.
- To send a configuration to a device, you must have the proper device description installed on Trex. The installed device description must be for the same device type, and equal to or greater than the device rev of the configuration.
- You cannot save or send configurations when using the generic device description.

## 3.4 Automatically detect a device

The Field Communicator application can automatically detect a device, without requiring any input from you. When you open the Field Communicator application or when the **Connect - Select** screen is displayed, the Trex unit checks for the most common connection scenarios and if possible, detects the connected device and displays the Device List. You can then select a device and display its device menu. The auto-detect feature lets you skip the device connection wizard in the Field Communicator application, which allows for faster connections to devices.

The Field Communicator application can automatically detect:

- A HART device that is on an externally-powered compliant HART loop, and the device is communicating at address zero.
- A 4-wire HART device that is communicating at address zero. (This may require a resistor across the HART terminals. Check the device documentation for the proper connection.)
- A *WirelessHART* device that is powered by its battery, and the device is communicating at address zero.

- A powered FOUNDATION fieldbus segment that is actively communicating. The fieldbus segment must have a host system or a FOUNDATION fieldbus device that is the Link Active Scheduler (LAS).

While the Trex unit is connecting to the device, the **Auto-Detect** screen is displayed to show the status.

---

**Note**

For HART devices, the Field Communicator application can automatically detect and connect to the device if the **Auto-Connect** option in the Field Communicator **Settings** is enabled. If this option is enabled, the device menu is displayed rather than the Device List.

---

### 3.4.1 Automatically connect to a HART device

The Field Communicator application can automatically detect and connect to a HART device, without requiring any input from you. When you open the Field Communicator application or when the **Connect - Select** screen is displayed, the Trex unit checks for the most common connection scenarios and, if possible, connects to the device and displays the device menu.

To use the auto-connect feature, ensure the **Auto-Connect** option is enabled (**Field Communicator App Settings** → **Auto-Connect**), and the Trex unit is connected to one of the following:

- A HART device that is on an externally-powered compliant HART loop, and the device is communicating at address zero.
- A 4-wire HART device that is communicating at address zero. (This may require a resistor across the HART terminals. Check the device documentation for the proper connection.)
- A *WirelessHART* device that is powered by its battery, and the device is communicating at address zero.

If the Trex unit cannot automatically connect to the device, tap **HART** on the **Connect - Select** screen and follow the prompts from the device connection wizard to connect to the device.

---

**Note**


You can disable the Field Communicator application from automatically connecting to a device at address zero. If you disable this option, the Trex unit still detects the device at address zero, but you need to select the device on the **Device List** to connect and view the device screens. You may also want to disable this option if the Trex unit is connected to a transmitter at address zero with a THUM adapter.

---

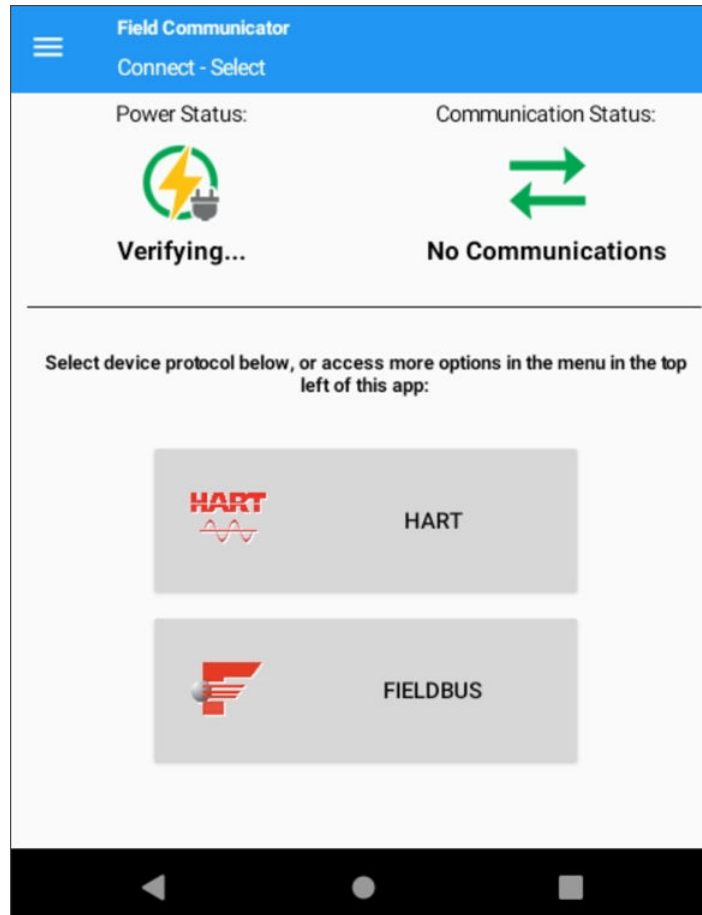
## 3.5 Connect - Select screen

If the Trex unit cannot automatically detect or connect to the device when you open the Field Communicator application, the **Connect - Select** screen is displayed. The **Connect - Select** screen is the home screen for the Field Communicator application.

You can do the following on the **Connect - Select** screen:

- Connect the lead set to the Trex unit and to the device to try to automatically detect/connect to the device. If the device meets the criteria for automatically connecting, the Trex unit tries to connect to the device.
- Tap **HART** or **Fieldbus** to start the device connection wizard and connect to the device.
- Select **Offline** from the application menu  to simulate a device.

**Figure 3-1: Connect - Select screen**



Option	Description
Power Status	Detect voltage on the lead set.
Communication Status	Detect if a connected device is communicating with the Trex unit.
HART	Connect to a live HART device. Tap this option if the Trex unit could not automatically detect or connect to the device. The device connection wizard is displayed.



Option	Description
Fieldbus	Connect to a live FOUNDATION fieldbus device. Tapping <b>Fieldbus</b> starts the Trex unit's communications if external power is detected, and the Trex unit assumes the role of network master (LAS), if no other master exists. The device connection wizard is displayed. (The Fieldbus option is displayed only if Trex unit is licensed for FOUNDATION fieldbus.)

**Related information**

[Status when detecting a device](#)

### 3.6 Device connection wizard

If the Trex unit cannot automatically detect or connect to the device, tap **HART** or **Fieldbus** on the **Connect - Select** screen to start the device connection wizard. The wizard displays a set of questions to help you connect to the device. You may see one or more of the questions below depending on the setup of your device. The questions may appear in a different order than listed below.

- Do you intend to provide power from the Trex unit? (This is available only if the Device Communicator Plus communication module is attached to the Trex unit.)
- Is the Trex unit connected to a transmitter or a positioner?
- Do you want to change the polling options?
- Do you want to increase loop resistance? (This enables the internal resistors.)
- Do you want to increase loop current? (This is available for only positioners.)

In the Field Communicator application, the device connection wizard is the only way to enable the Trex unit to power a device, change the polling options for HART and fieldbus, enable the internal resistors within the Trex unit, or increase current to positioners.

If the device connection wizard completes its process and cannot connect to the device, a message is displayed. Tap **Cancel** to return to the **Connect - Select** screen to retry the connection process.

**Note**

The selections are not saved in the device connection wizard. You need to select the desired options each time you connect to a device.

**Note**

If you tap Back during the device connection wizard, the change you made on that screen is canceled and the previous screen is displayed. For example, if you enabled the Trex unit to provide power and changed the polling address from 0 to 63 and then tapped the Back button, the polling address is set to the default value of 0, but the Trex unit still powers the device. You can also tap Back to return to a previous question and provide a different answer/selection.

### Problems the device connection wizard can detect

The device connection wizard can also identify common wiring problems, including if the wrong terminals on the Trex unit are used or if a lead set is not connected to the device or the Trex unit. If a problem is detected, a message describes the problem or a graphic shows the correct wiring.

The Trex unit continuously monitors the voltage and current at the terminals where the lead set is connected. The Field Communicator application displays a message if an error is detected, including if the lead set is removed from the device or Trex unit. For example, if you try to enable the Trex unit to power a device that already has power, the Field Communicator application displays a message that voltage was detected and the Trex power supply is turned off to protect the device and Trex unit.

In some cases, you may be able to override the warning from the device connection wizard. For example, some devices may hold voltage for several minutes after being disconnected from the power supply. If you enable the Trex unit to power a device that is still holding a low voltage (less than 8 volts), a message is displayed that the Field Communicator application detects low voltage and asks if the Trex unit is connected to a digital control system's control loop. You can override this warning and apply power if you are sure the device is not connected to an external power supply.

If the device connection wizard detects a problem, you can fix the issue while the connection wizard is displayed. The change is updated in the **Power Status** and **Communication Status** sections.

## 3.7 Status when detecting a device

When the Trex unit tries to detect and connect to a device, the Power Status option and the Communication Status option on the Connect - Select screen show one of the following status messages.


Power Status Message	Description
Voltage Detected on HART	Typical status for connecting across HART device's communication terminals when the device is on an externally-powered loop. The detected voltage is greater than or equal to 8 volts.
Voltage Detected on HART+pwr	The detected voltage is greater than or equal to 8 volts.

Power Status Message	Description
Low Voltage Detected on HART	<p>Typical status for connecting:</p> <ul style="list-style-type: none"> <li>To a 4-wire HART device</li> <li>To a <i>WirelessHART</i> device</li> <li>Across a resistor</li> <li>Across HART control system modules</li> </ul> <p>The detected voltage is between 0.5 and 8 volts.</p> <p><b>Note</b> You may see this status when the AC adapter is attached to the Trex unit. If low voltage is detected, disconnect the AC adapter.</p> <p><b>Note</b> This message can also appear if the Trex unit connects to a device that was recently powered. Some devices may hold voltage for several minutes after being disconnected from its power supply. The Trex unit provides a warning message that it detects voltage.</p> <p>If you try to power a device when this occurs, the Trex unit asks if you want to ignore the voltage warning and proceed with sourcing power. If you select Yes, the Trex unit powers the device.</p>
Low Voltage Detected on HART + pwr	The detected voltage is between 0.5 and 8 volts.
No Voltage Detected	<p>Typical status for connecting:</p> <ul style="list-style-type: none"> <li>An unpowered device.</li> <li>To some types of 4-wire HART devices.</li> <li>To some types of <i>WirelessHART</i> devices.</li> </ul> <p>This status is also displayed when the lead set is not connected to a device, or when the Trex unit is connecting to a device.</p>
Voltage Detected on FF	<p>Typical status for connecting to an externally-powered fieldbus segment.</p> <p>The detected voltage is greater than or equal to 8 volts.</p>
Low Voltage Detected on FF	The measured voltage is less than 8 volts.
Voltage Provided from FF pwr	The typical status when the Trex unit is powering the FOUNDATION fieldbus device. The detected voltage is greater than or equal to 8 volts.
Voltage Provided from HART+ pwr	The typical status when the Trex unit is powering the HART device. The detected voltage is greater than or equal to 8 volts.

Power Status Message	Description
Voltage on Multiple	The Trex unit has detected voltage on more than one terminal. This may be due to the following: <ul style="list-style-type: none"> <li>The AC adapter is attached to the Trex unit and is charging the power module. Disconnect the AC adapter from the Trex unit.</li> <li>Noise is detected on the network.</li> <li>Two lead sets are connected to two different fieldbus segments or loops. This is not recommended.</li> </ul>

Communication Status	Description
No Communication	The Trex unit has not detected any HART or fieldbus communication.
Fieldbus Detected	The Trex unit has detected FOUNDATION fieldbus communication.
HART Detected	Typical status when the Trex unit detects: <ul style="list-style-type: none"> <li>A HART device in burst mode.</li> <li>Active HART communication from the digital control system.</li> <li>A response to a polling message sent to the device.</li> </ul> This status may be sporadic and may alternate between HART Detected and No Communication. If unexpected communications are detected, remove the AC adapter to isolate the Trex unit from noise.

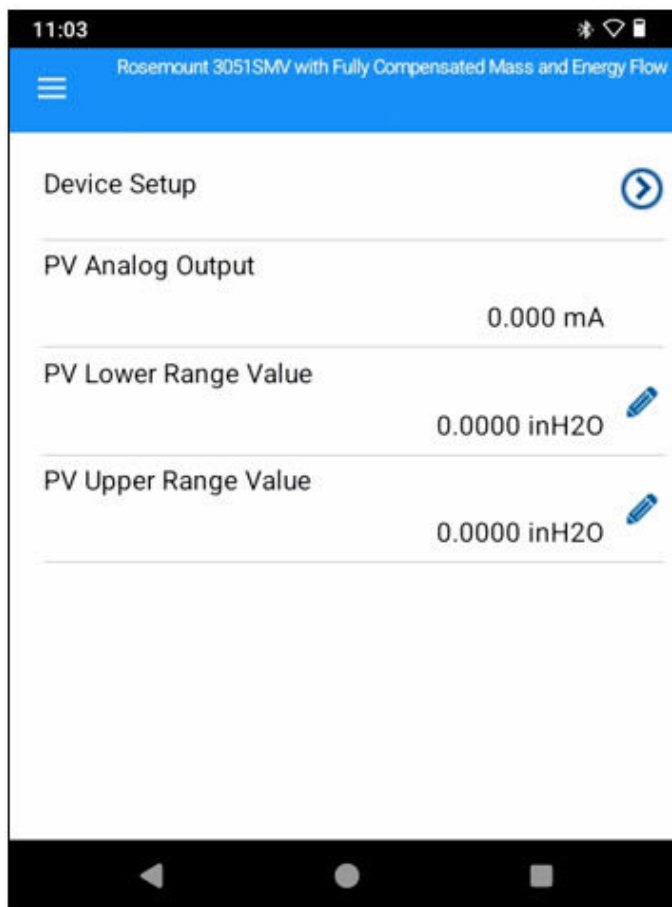
## 3.8 Online Menu or Device Dashboard

Depending on the device description (DD) for a device, the first screen is an online menu or a device dashboard menu. All devices show a Menu  at the top of the screen.

### Online menu

An online menu may display the following options, depending on the device type:

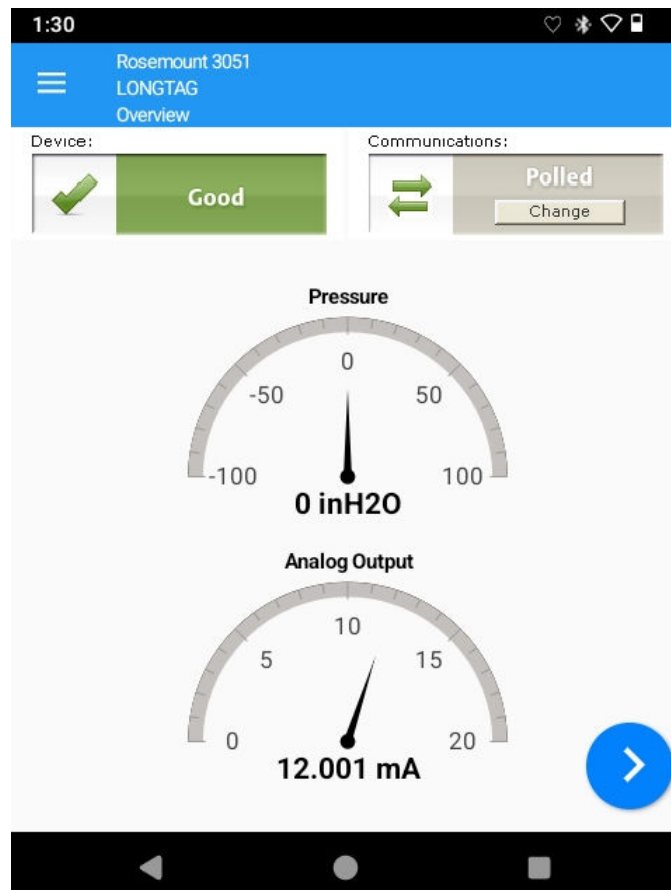
- Device setup
- Primary variable (PV)
- Analog output (AO)
- PV lower range value (LRV)
- PV upper range value (URV)

**Figure 3-2: Online menu example****Dashboard menu**

A device dashboard menu displays the same parameters as the **Online** menu.

- **Overview** - View a graphical representation of the process variable. Tap the **More** arrow on the bottom right side of the screen to access additional menu items. Depending on the device description, the images under "Device" and "Communications" may be selectable links.

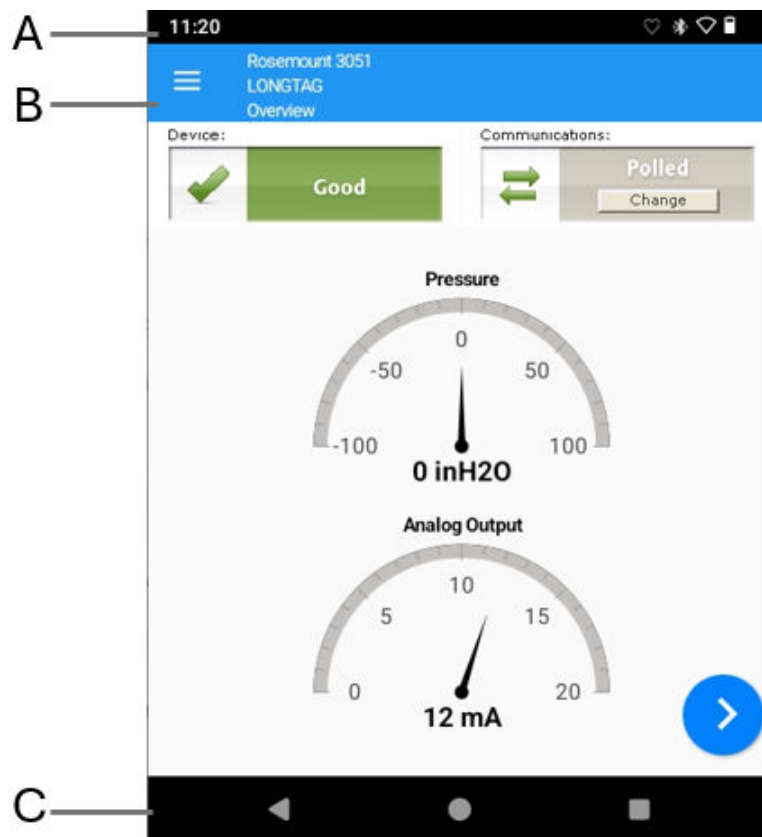
Figure 3-3: Dashboard menu example



### 3.8.1 Device screen layout

In the Field Communicator application, the device screens have three main parts:

Figure 3-4: Sections of a device screen



- A. Status bar
- B. Application title bar
- C. Navigation bar

### Status bar

Displays information about the current state of Trex applications and settings.


### Application title bar

Displays the type of device the Trex unit is connected to, the device tag (short tag or long tag), and the menu title (Overview). If you tap the application menu in the title bar, the menu expands and displays the menu options.

### Navigation bar

Use the buttons along the bottom of the screen for quick navigation between Trex applications.

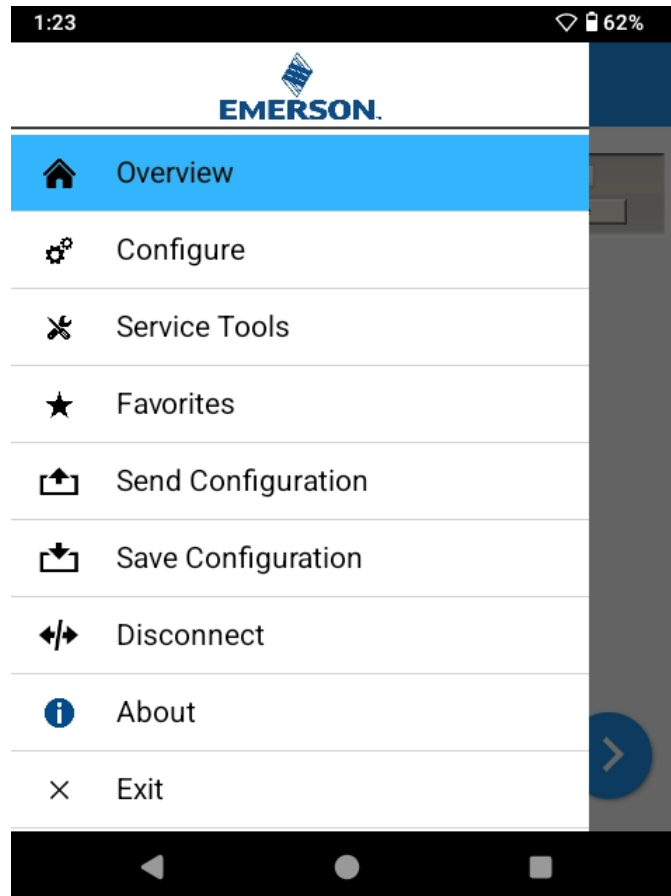
## 3.8.2 Application menu

Tapping the application menu  lists the main options for the connected device. Depending on the device description, you may see different menu options than the one

described below. See the device documentation for more detailed descriptions of these options.

From the application menu you can connect/disconnect a device, edit and save a configuration, send a configuration (only for a connected device), set a favorite, or disconnect to simulate a device.

**Figure 3-5: Menu for a connected HART device**

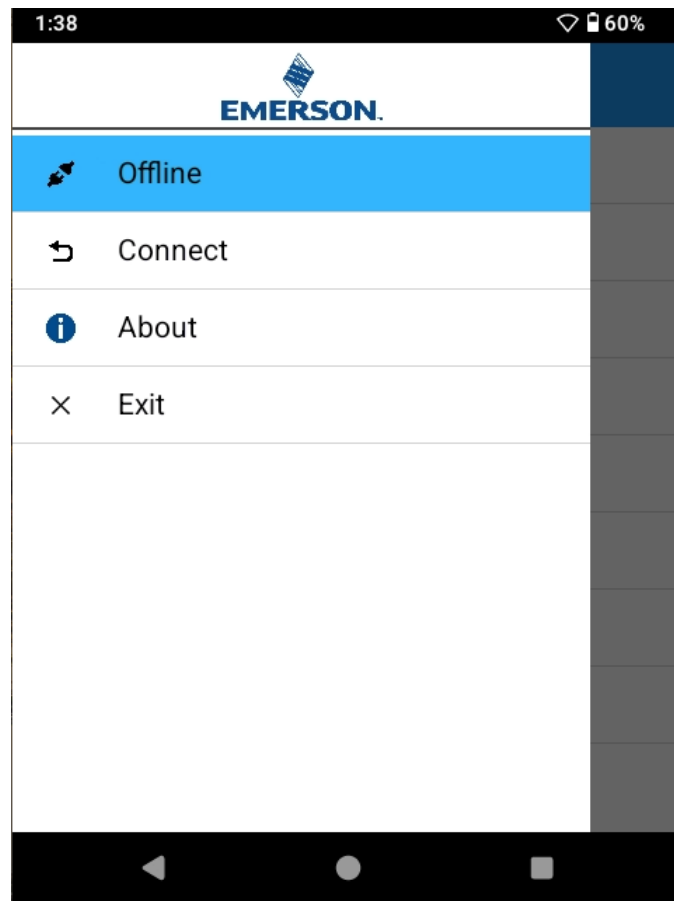


Option	Description
Overview	View a graphical representation of the process variable. The More option lets you access the device parameters.
Configure	Configure the device parameters.
Service Tools	View and modify options for alerts, variables, and maintenance. For FOUNDATION fieldbus devices, commonly used parameters are also accessible, including the device tag, device address, IO block schedule, link master configuration, and device information.
Favorites	Save frequently used menu items to a list for quick access. The Favorites option is available for only HART devices.
Send Configuration	Send a configuration to a connected HART device. This option is displayed only if a device is connected to the Trex unit.



Option	Description
Save Configuration	Save a configuration for this device to the AMS Trex unit.
Disconnect	Tap <b>Disconnect</b> to stop communicating with a device. The Trex unit also stops powering the device when you tap <b>Disconnect</b> .
About	Tap <b>About</b> to view the version number of the installed application.
Exit	Tap to exit the application.








**Figure 3-6: Menu for no connected HART device**



Option	Description
Offline	Simulate a connected device to become familiar with the menus before configuring the device in a critical environment. This option does not require communication with a device. (The Fieldbus option is displayed only if the Trex unit is licensed for FOUNDATION fieldbus.)
Connect	Tap <b>Connect</b> to return to the <b>Connect - Select</b> screen and connect to a device.
About	Tap <b>About</b> to view the version number of the installed application.
Exit	Tap to exit the application.

## 3.9 Icons on the device menus

When the Trex unit is connected to a device, the device menu may have one or more icons.

Icon	Description
	The option is a parameter you can edit, such as the device tag.
	The option is a device method, such as a loop test.
	The option has a submenu with additional options.
	The option is a graph or chart. Charts display a graphic view of variables as they occur over time.
	The option is a gauge chart. A gauge chart formats device data into a view similar to an analog car speedometer and plots device data varying with time.
	The option is a grid.
	The option is an image.
No icon	The option is a process variable. The process variable value may or may not be displayed, depending on the device description for the device.

## 3.10 Connections to HART devices

The Trex unit can communicate with a device from the control room, on the bench, or any wiring termination point in the loop. Review the HART wiring diagrams to ensure the Trex unit is correctly connected to the device.

### Note

The Trex unit acts as a secondary HART master on a HART loop.

### Related information

[Internal resistors](#)

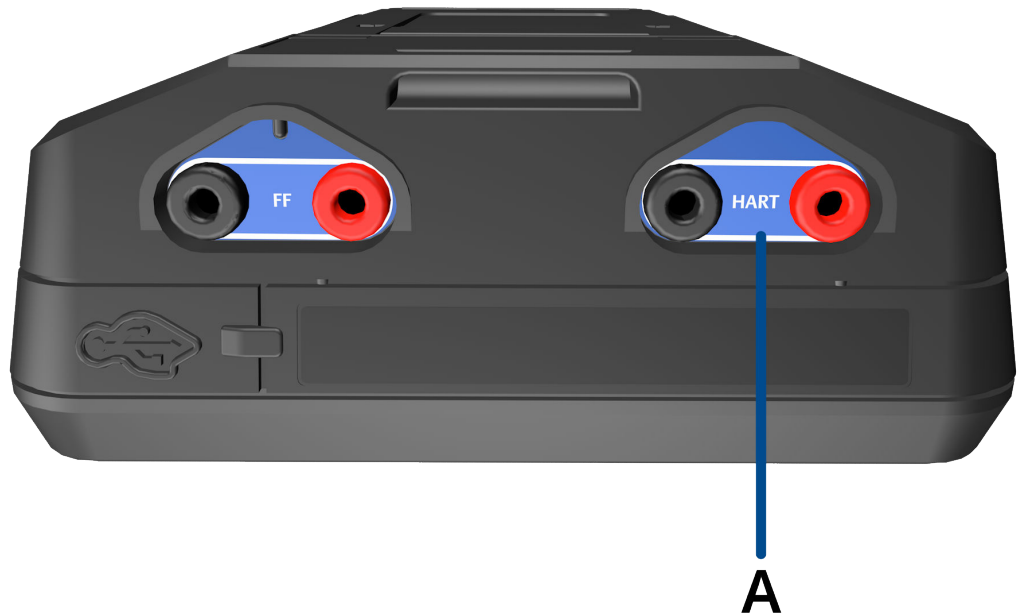
### 3.10.1 HART communication terminals

The Trex unit has communication terminals that enable it to communicate with a HART device. Insert the lead set into the red and black terminals and connect to a HART device.

### Note

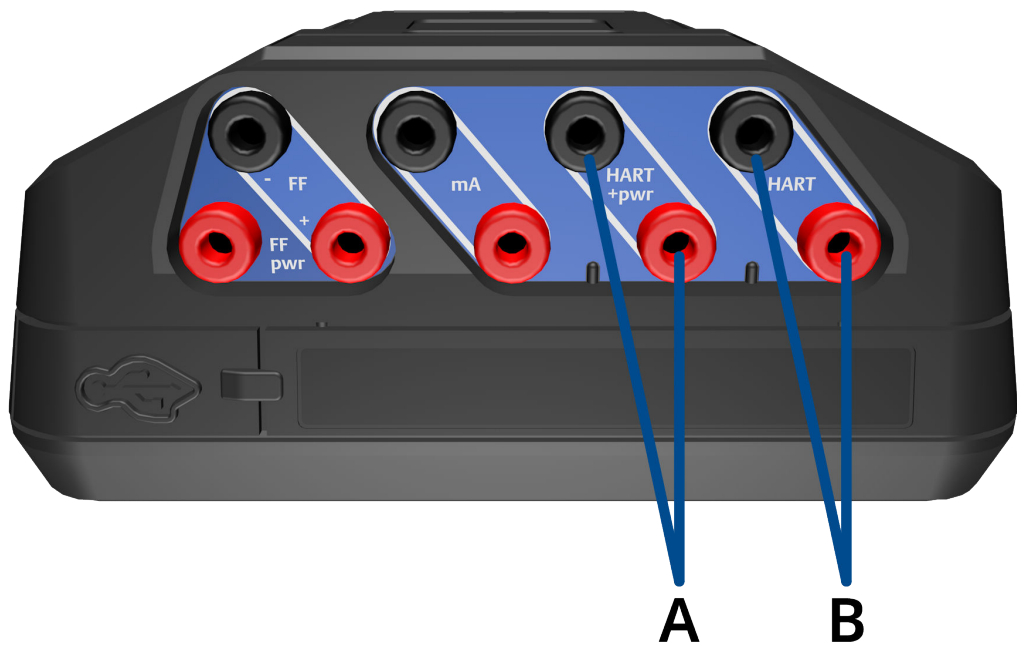
The lead set must be used to communicate with a wired or wireless device.

Figure 3-7: HART communication terminals on the Device Communication Module



A. Communicate with an externally-powered HART device

Figure 3-8: HART communication terminals on the Device Communication Plus Module



A. Power and communicate with a HART device.  
B. Communicate with an externally-powered HART device.

**Related information**

[Wiring diagrams for HART devices](#)  
[Power and connect to a HART device](#)

### 3.10.2 Wiring diagrams for HART devices

The Trex unit can communicate with a device from the control room, on the bench, or any wiring termination point in the loop. Connect the lead set to the Trex unit and to the communication terminals on the device or across the resistor.

Below each diagram, a table lists the expected prompts from the device connection wizard and the answers to complete the connection. The prompts appear only if the Field Communicator application could not automatically detect or connect to the device.

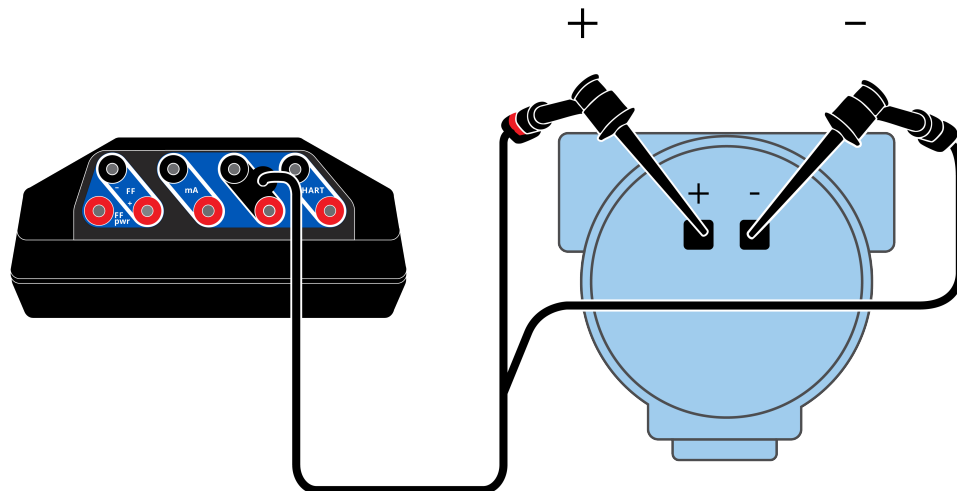
**Note**

The Trex unit acts as a secondary HART master on a HART loop.

**⚠ CAUTION**

Remove the USB cable from the Trex unit before connecting to a device.

**Figure 3-9: Power and connect to a 2-wire HART transmitter**



**Note**

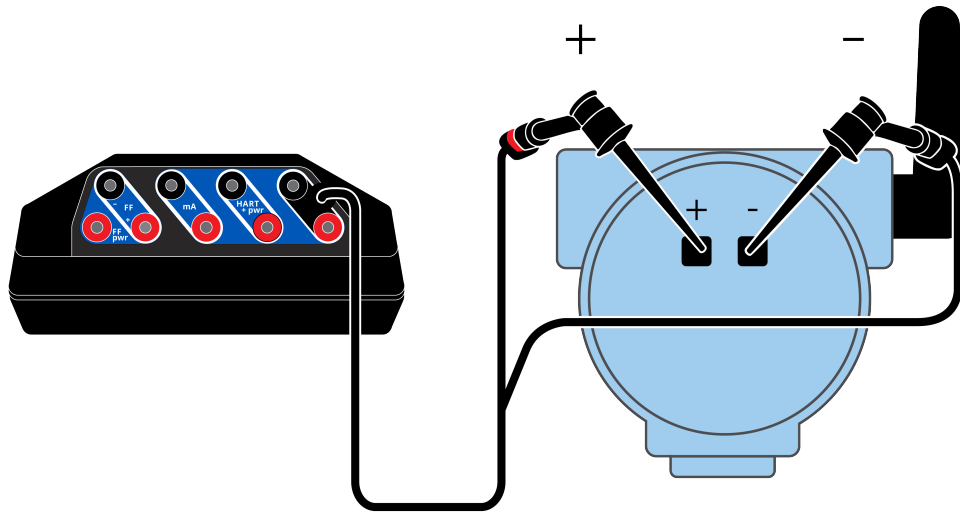
When the Trex unit powers the HART transmitter, an external resistor is not needed. The Trex unit uses an internal resistor that is automatically used when you enable the Trex unit to power the transmitter.

**Note**

Do not insert a resistor in parallel with either the HART+pwr or HART terminals on the Trex unit, or in parallel with the device's communication terminals. This may prevent communications.

Device connection wizard prompts	Answer
Do you intend to provide power from the Trex unit?	Yes
Are you providing power to a transmitter or positioner?	Transmitter
Change Polling Option?	Tap Yes if the device is not at address zero.

**Figure 3-10: Connect to a powered *WirelessHART* device (with its battery attached)**

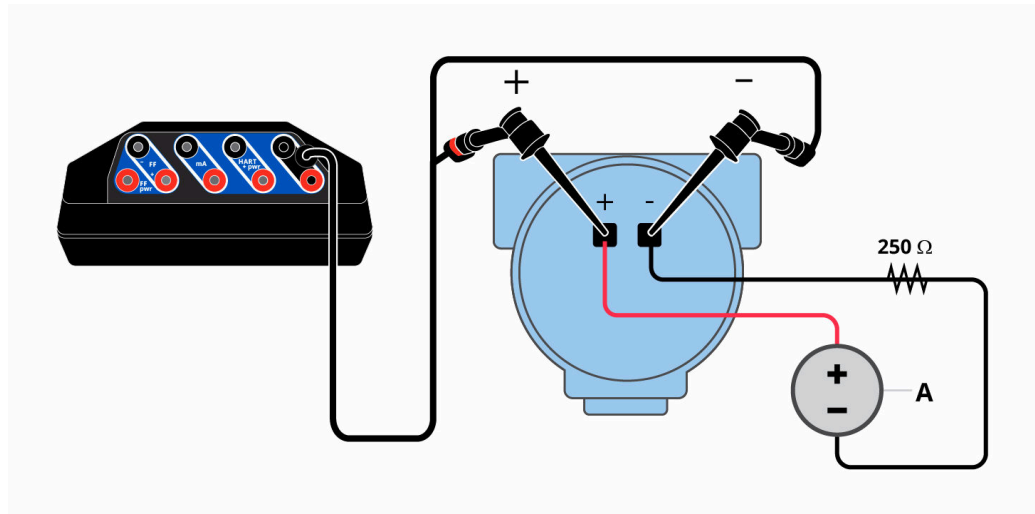


**⚠ CAUTION**

Do not use the Trex unit to power a *WirelessHART* device. Providing power to a *WirelessHART* device may damage the device.

Device connection wizard prompts	Answer
Do you intend to provide power from the Trex unit?	No
Leads are attached to:	Transmitter
Change Polling Option?	Tap Yes if the device is not at address zero.

**Figure 3-11: Connect to an externally-powered 2-wire HART transmitter**

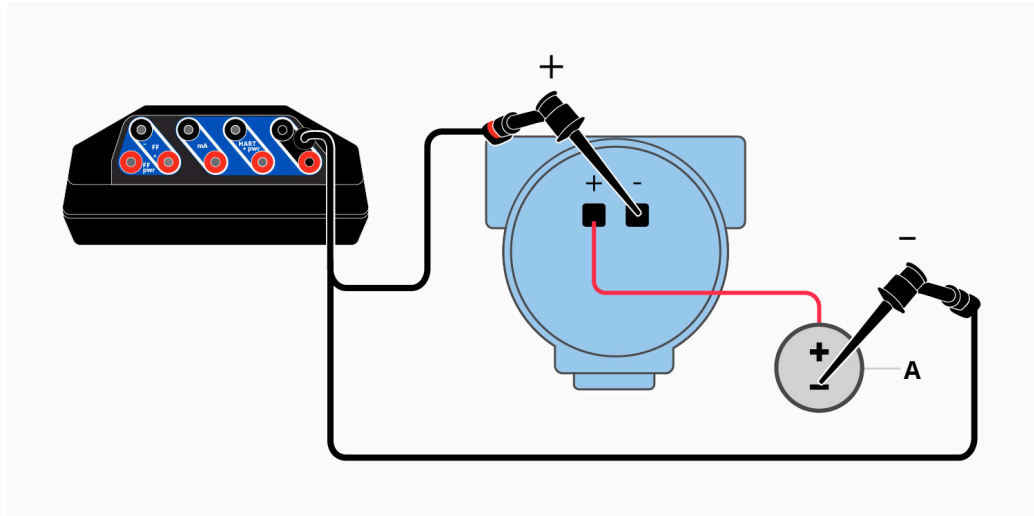


If the transmitter is at address zero, the Trex unit may automatically detect and connect to the device without any prompts from the device connection wizard.

A – Voltage source - Use voltage source with double insulation.

Device connection wizard prompts	Answer
Do you intend to provide power from the Trex unit?	No
Leads are attached to:	Transmitter
Change Polling Option?	Tap Yes if the device is not at address zero.

**Figure 3-12: Connect to an externally-powered 2-wire HART transmitter and use the Trex internal resistor**



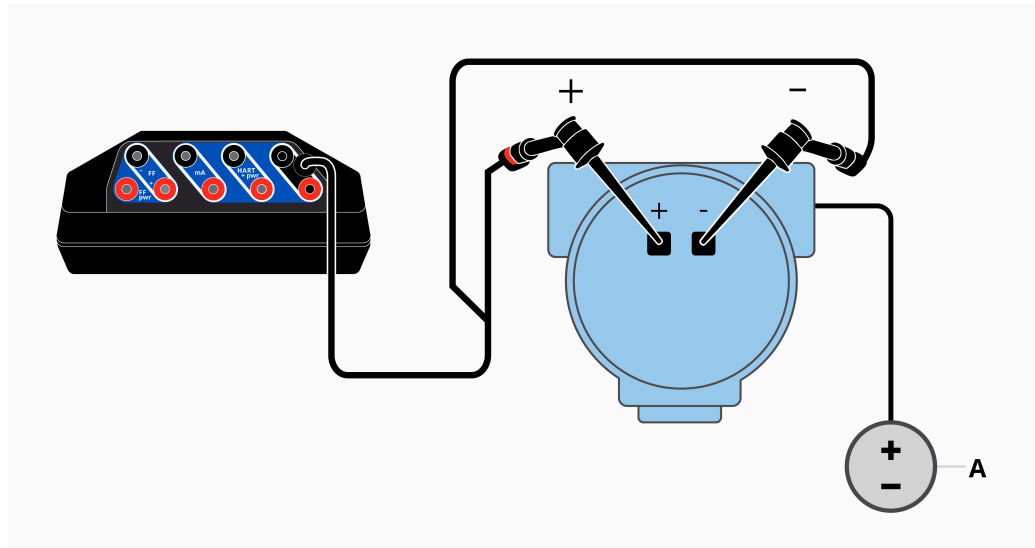
**Note**

The Trex unit must be connected in series with the transmitter to use the internal resistor. Do not put more than 25V DC on the circuit.

A – Voltage source - Use voltage source with double insulation.

Device connection wizard prompts	Answer
Do you intend to provide power from the Trex unit?	No
Leads are attached to:	Transmitter
Change Polling Option?	Tap Yes if the device is not at address zero.
Increase loop resistance?	Tap Yes to enable the internal resistor.

**Figure 3-13: Connect to a 4-wire HART transmitter**



If you have a 250 Ohm resistor, you can insert it in between the device terminals and connect the lead set across the resistor. Otherwise, you can enable the internal resistor in the device connection wizard.

**Note**

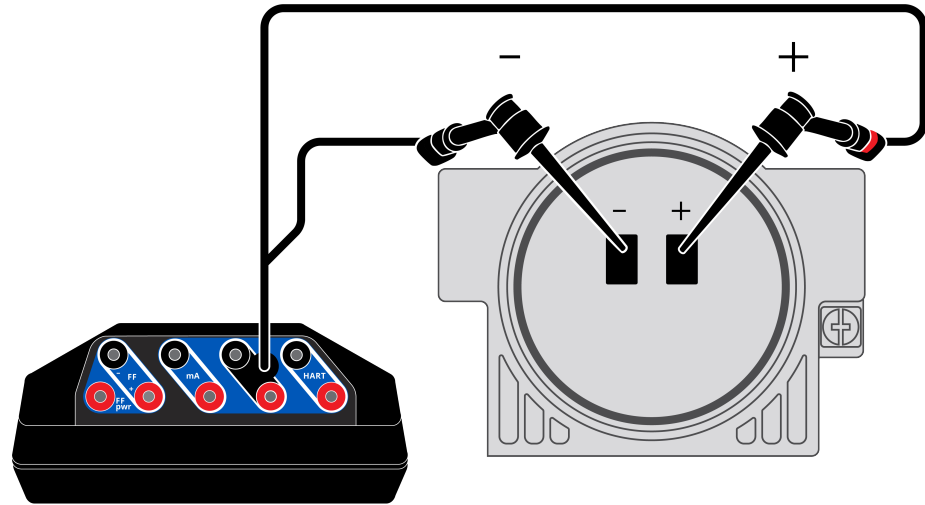
Ensure you review the device documentation for connecting/setting up HART communication. Devices may have different terminals or requirements.

A – Voltage source - Use voltage source with double insulation.

Device connection wizard prompts	Answer
Do you intend to provide power from the Trex unit?	No
Leads are attached to:	Transmitter
Change Polling Option?	Tap Yes if the device is not at address zero.
Increase loop resistance?	Tap Yes if there is no external resistor between the device terminals.

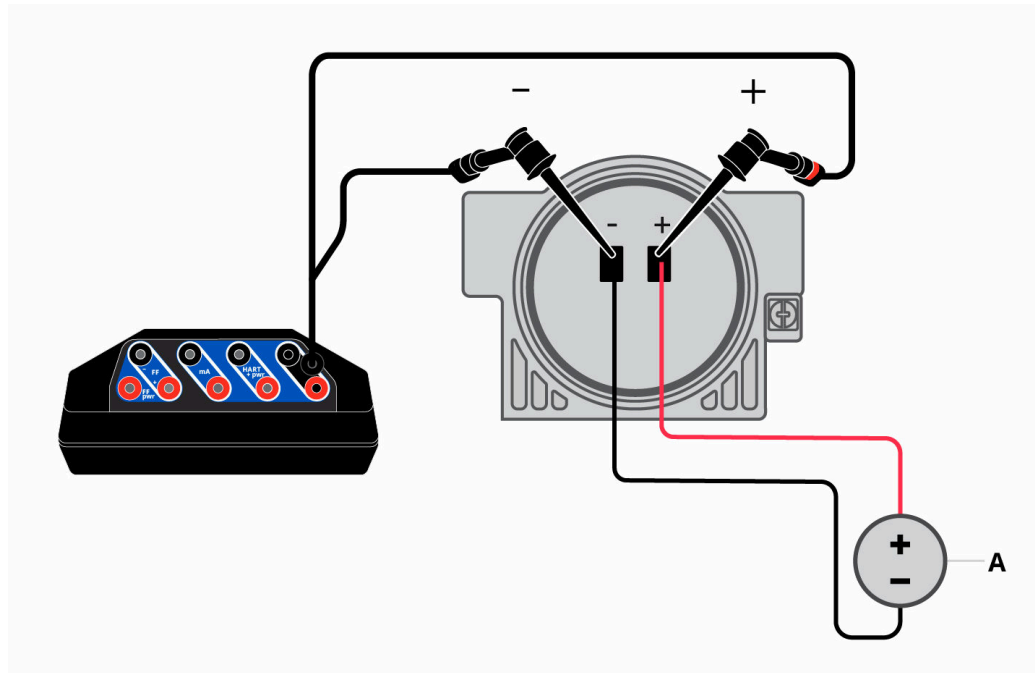


**Figure 3-14: Power and connect to a HART positioner**



Device connection wizard prompts	Answer
Do you intend to provide power from the Trex unit?	Yes
Are you providing power to a transmitter or positioner?	Positioner
Change Polling Option?	Tap Yes if the device is not at address zero.
Increase loop current?	Tap Yes to increase the current from 4 mA to another value, if the device did not initially communicate.

**Figure 3-15: Connect to an externally-powered HART positioner**



A — Current source

Device connection wizard prompts	Answer
Do you intend to provide power from the Trex unit?	No
Leads are attached to:	Positioner
Change Polling Option?	Tap Yes if the device is not at address zero.

**Related information**

- [HART communication terminals](#)
- [Connect to an externally-powered HART device](#)
- [Power and connect to a HART device](#)
- [Internal resistors](#)

### 3.10.3 Wiring diagrams for the Smart Wireless THUM™ Adapter

Below each diagram, a table lists the expected prompts from the device connection wizard and the answers to select to complete the connection.

If you are using a *WirelessHART* adapter that is not the Smart Wireless THUM adapter, review its documentation before connecting the Trex unit.

**Note**

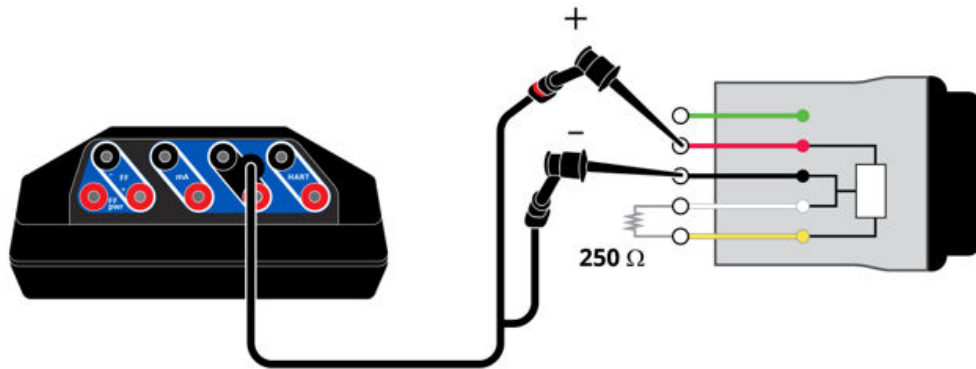
- Review the documentation included with the THUM adapter for additional information.

- The Trex unit acts as a secondary HART master on a HART loop.

**⚠ CAUTION**

Remove the USB cable from the Trex unit before connecting to a device.

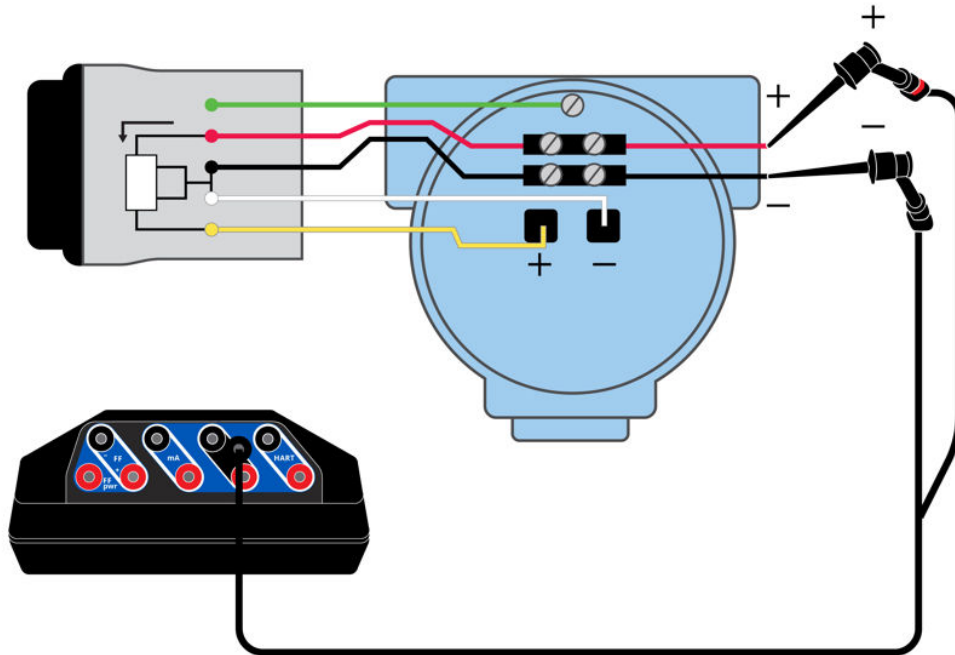
**Figure 3-16: Power the THUM adapter without a device attached and use 250 Ohm resistor**



Connect the lead set to the red and black wires.

Device connection wizard prompts	Answer
Do you intend to provide power from the Trex unit?	Yes
Are you providing power to a transmitter or positioner?	<b>Positioner</b> Select <b>Positioner</b> because the Trex unit needs to control/limit current due to the lower value of the resistor.
Change Polling Option?	Tap <b>Yes</b> and select the address for the THUM adapter.

**Figure 3-17: Power and communicate with the THUM adapter attached to a HART transmitter**

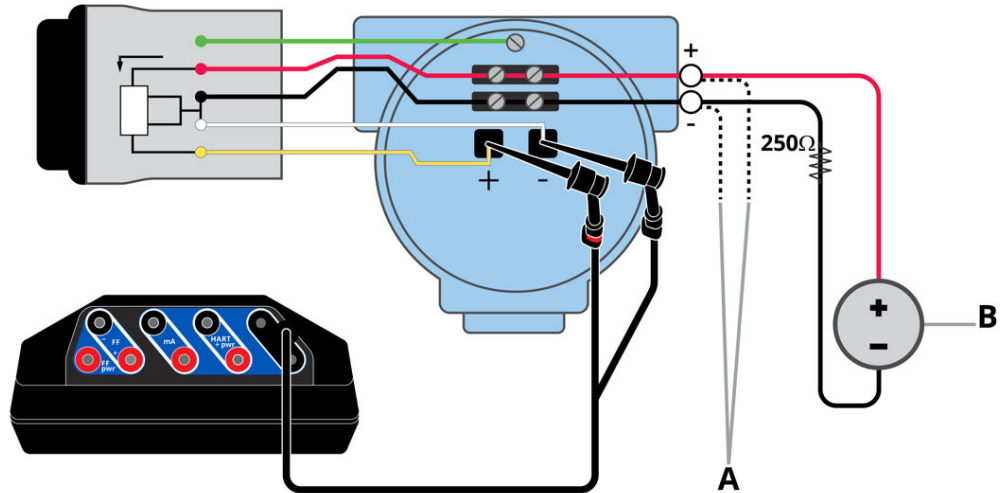


**Note**

If you want to communicate with the THUM adapter rather than the device, ensure the Auto-Connect option for the Field Communicator Settings is disabled. This allows the Field Communicator application to detect both the THUM adapter and the transmitter, and let you select which one to communicate with.

Device connection wizard prompts	Answer
Do you intend to provide power from the Trex unit?	Yes
Are you providing power to a transmitter or positioner?	Transmitter
Change Polling Option?	Tap Yes and select the address for the THUM adapter, the device, or "0,63" for both.

**Figure 3-18: Communicate with the THUM adapter attached to a powered HART transmitter**



Connect the lead set to the yellow and white wires.

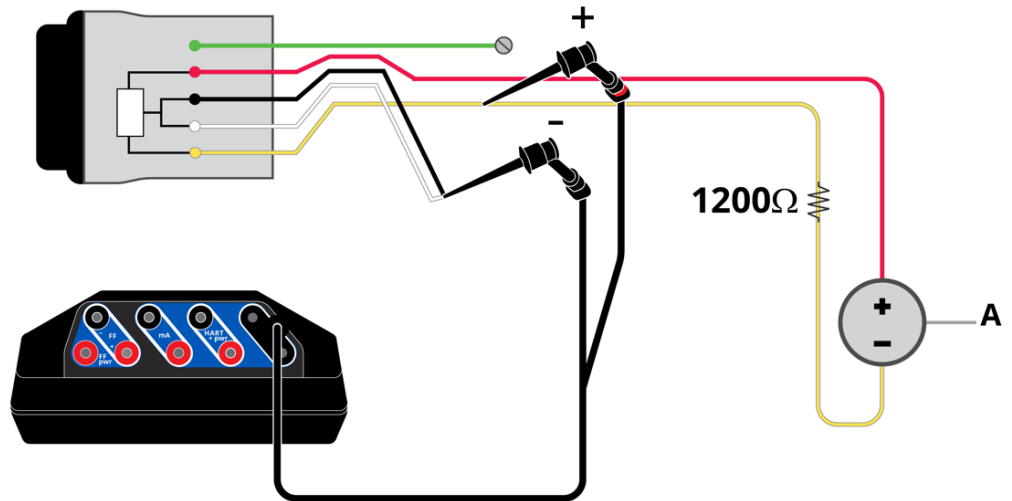
**Note**

If you want to communicate with the THUM adapter, ensure the Auto-Connect option for the Field Communicator Settings is disabled. This allows the Field Communicator application to detect both the THUM adapter and the transmitter, and let you select which one to communicate with.

- A. *Optional connection if the yellow and white wires are inaccessible.*
- B. *Voltage source - Use voltage source with double insulation.*

Device connection wizard prompts	Answer
Do you intend to provide power from the Trex unit?	No
Leads are attached to:	Transmitter
Change Polling Option?	Tap Yes and select the address for the THUM adapter, the device, or "0,63" for both.

**Figure 3-19: Communicate with the THUM adapter powered by a voltage source**

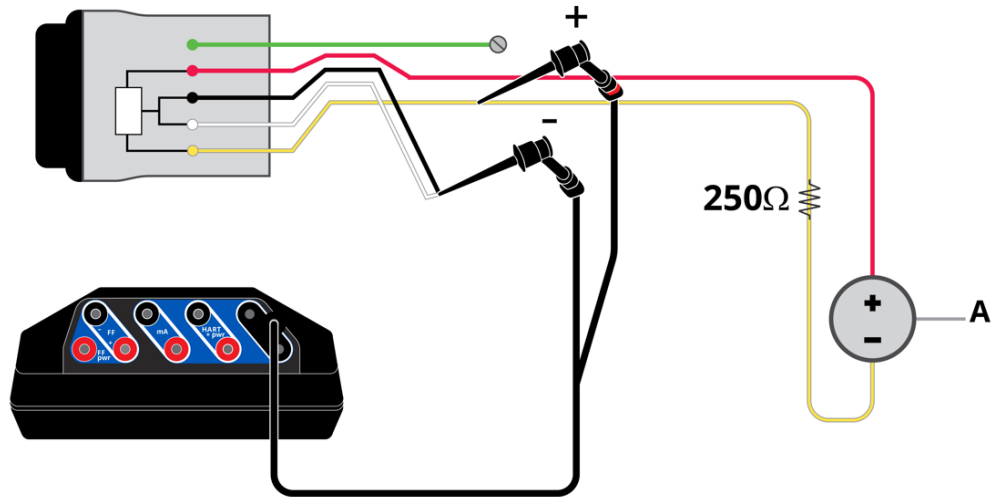


Connect the lead set to the yellow and white/black wires.

A. Voltage source - Use voltage source with double insulation.

Device connection wizard prompts	Answer
Do you intend to provide power from the Trex unit?	No
Leads are attached to:	Transmitter
Change Polling Option?	Tap Yes and select 63.

**Figure 3-20: Communicate with the THUM adapter powered by a current source**



Connect the lead set to the yellow and white/black wires. The 250 Ohm resistor is not required, but it may be used to verify current.

A. Current source.

Device connection wizard prompts	Answer
Do you intend to provide power from the Trex unit?	No
Leads are attached to:	Positioner
Change Polling Option?	Tap Yes and select 63.

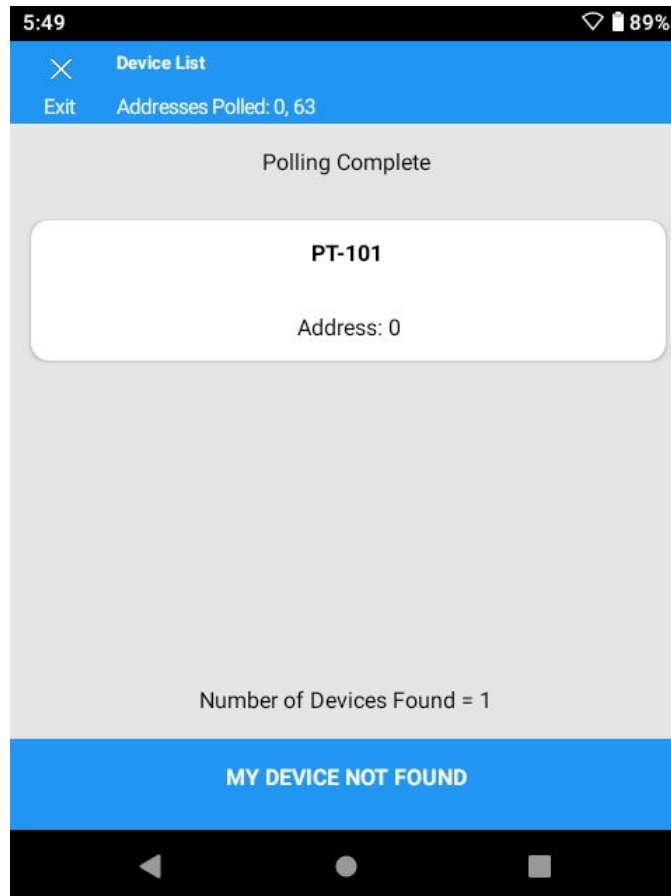
### 3.10.4 HART Device List

The Device List displays the devices that the Trex unit has detected. Each device is listed by its tag and address. The Device List will not display when the Auto-Connect option for the Field Communicator application is enabled and a device was found at address zero.

Tap a device displayed on the Device List to connect to it.

If a device is not listed, tap **My Device Not Found** to change the HART polling options.

Figure 3-21: HART Device List



### 3.11 Internal resistors

The Trex unit has internal resistors that can be used when the Trex unit powers a HART transmitter, or when the HART transmitter is on a 4-20 mA current loop without a resistor. The resistors are enabled through the device connection wizard in the Field Communicator application.

**Note**

For positioners, the internal resistors in the Trex unit are disabled.



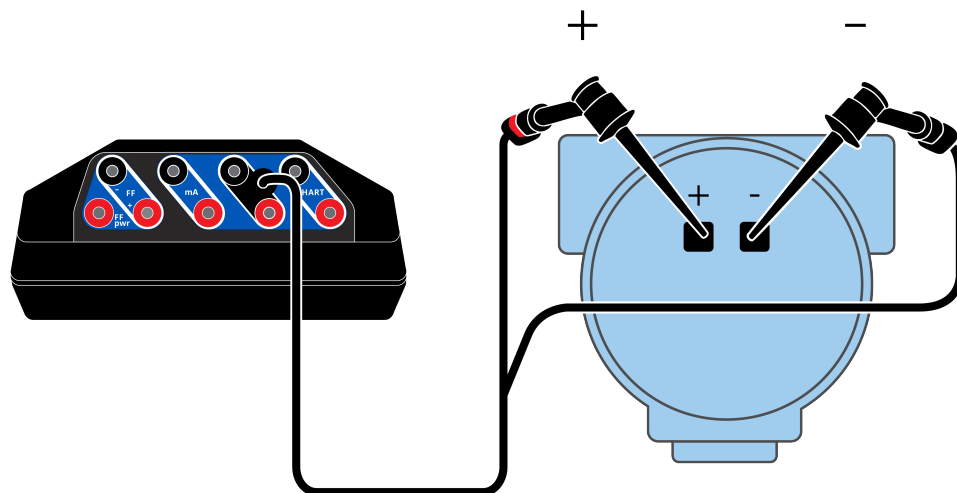
### Available resistors

Resistor	Use
167 Ohm	Used when the Trex unit powers a HART transmitter. This is the only resistor that is available when the Trex unit powers a transmitter.  The 167 Ohm resistor is available due to Intrinsic Safety limitations when the Trex unit powers a device. If the current is high (for example 22.5 mA), the voltage drops to a level that may not be enough to power the device. The use of the lower valued resistor can reduce the amount of the voltage drop. The HART signal is lower, but the shout/deaf mode helps increase the HART signal amplitude for devices that do not meet the HART specifications.
250 Ohm	Used when you select to increase loop resistance in the device connection wizard when connecting to a device on an externally-powered 4-20 mA current loop.
500 Ohm	Used when the Trex unit detects the current is too high for the 250 Ohm resistor on an externally-powered 4-20 mA current loop. If the current continues to be too high after adding this resistor, the Trex unit displays an error message indicating the detected current exceeds the capacity of the resistor. The 500 Ohm resistor is used for externally-powered current loops.

### Connection to a transmitter powered by the Trex unit

To enable the 167 Ohm resistor, the Trex unit must be connected to the device using the HART + pwr terminals.

**Figure 3-22: Connection for using the Trex internal resistor when the Trex unit powers the transmitter**

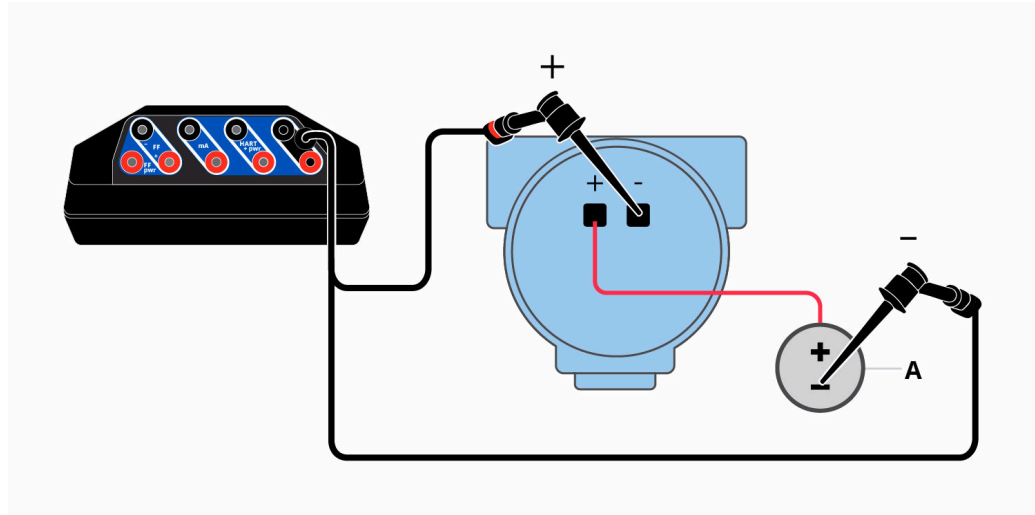


### Connections to externally-powered transmitters

To enable the internal resistors, the Trex unit must be connected to the device/loop in a specific way.

For externally-powered 2-wire HART devices, the Trex unit must be connected in series. In the diagram below, the Trex internal resistor is enabled in the HART terminals.

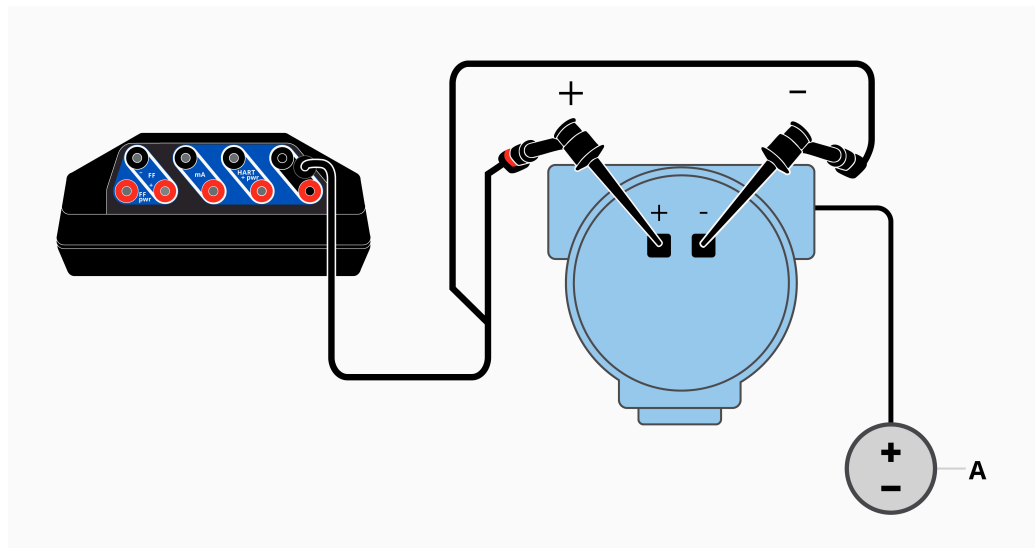
**Figure 3-23: Connection for using the Trex internal resistor for an externally-powered 2-wire transmitter**



A. Voltage source - Use a voltage source with double insulation.

For 4-wire transmitters, the Trex unit must be connected in parallel. In the diagram below, the Trex internal resistor is enabled in the HART terminals.

**Figure 3-24: Connection for using the internal resistor for a 4-wire transmitter**



A. Voltage source - Use a voltage source with double insulation.

### 3.11.1 Enable or disable the internal resistors

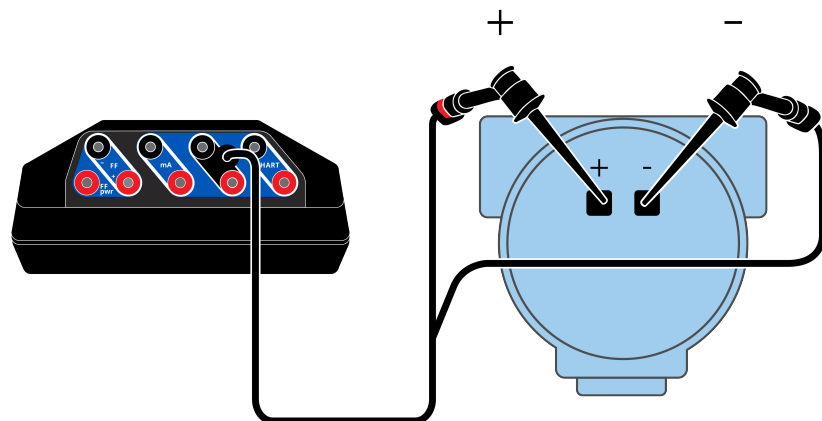
If the Trex unit powers the transmitter, there is no prompt/option to enable or disable the internal 167 Ohm resistor. The Trex unit automatically applies the resistor when you enable power to a transmitter from the device connection wizard.

If the Trex unit is connected to an externally-powered HART transmitter, the device connection wizard prompts you if you want to increase loop resistance. The Trex unit then selects the 250 Ohm or 500 Ohm resistor; you cannot select a specific value. The selected resistor value is not displayed on the screen.

#### Procedure

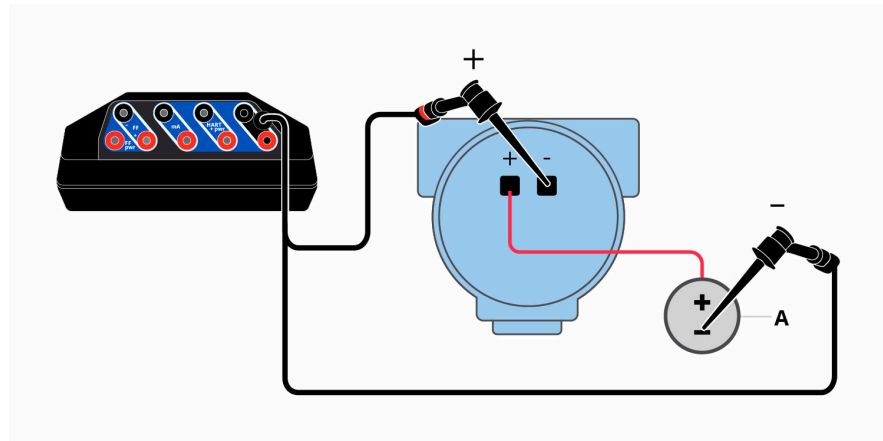
1. If you want the Trex unit to power a 2-wire HART transmitter, do the following:
  - a) Connect the lead set to the HART + pwr terminals on the Trex unit and to the communication terminals on the device.

**Figure 3-25: Connection for providing power to a 2-wire HART transmitter**



- b) In the Field Communicator application, tap **HART**.
  - c) Tap **Yes** when asked if you intend to provide power.
  - d) Tap **Transmitter**. The Trex unit applies the internal resistor.
  - e) Follow any additional prompts to connect to the device.
2. If the Trex unit is connected to an externally-powered 2-wire HART transmitter, do the following:
  - a) Connect the lead set to the HART terminals on the Trex unit and to the communication terminals on the device in-series. (If you are connecting to a 4-wire transmitter, connect the Trex unit in parallel.)

**Figure 3-26: Connection for an externally-powered 2-wire transmitter**



A. Voltage source - Use a voltage source with double insulation.

- b) Tap **HART**.
  - c) Tap **No** when asked if you intend to provide power.
  - d) Tap **Transmitter**.
  - e) Tap **No** when asked if you want to change polling. (This assumes the device is at address zero.)
  - f) Tap **Yes** when asked if you want to increase loop resistance.
  - g) Tap **Next**.  
A message is displayed to indicate the internal resistor is being enabled.
3. To disable the internal resistor, disconnect the device from the Trex unit, or close the Field Communicator application.

## 3.12 Power and connect to a HART device

The Trex unit can provide up to 16 volts (at 22.5 mA) to power a HART device. The Trex unit must have the communication plus module to power a HART device (transmitter or positioner).

You do not need to add an external resistor. The Trex unit has a 167 Ohm internal resistor in the HART + pwr terminals that is used when the Trex unit powers the transmitter.

If you try to apply power from the Trex unit when the device is externally-powered, the Field Communicator application prevents the Trex unit from supplying power. This protects the Trex unit from damage.

**⚠ CAUTION**

- The Trex unit cannot power a 4-wire device. Do not connect Trex unit to the power terminals of a 4-wire device. This can blow a fuse inside the Trex unit. The repair/replacement will need to be completed at an authorized service center.
- Remove the USB cable from the Trex unit before connecting to a device.
- Do not use the Trex unit to power a *WirelessHART* device. Providing power to a *WirelessHART* device may damage the device.

**⚠ WARNING**

Do not add any external power to the device when the Trex unit is powering the device. This can blow a fuse inside the Trex unit. The repair/replacement will need to be completed at an authorized service center. Ensure the device is disconnected from the loop/segment and no other wires are connected to the device before providing power from the Trex unit.

**Procedure**

1. Connect the lead set to the HART + pwr terminals on the Trex unit and to the communication terminals on the device.

**Figure 3-27: Power a HART transmitter**

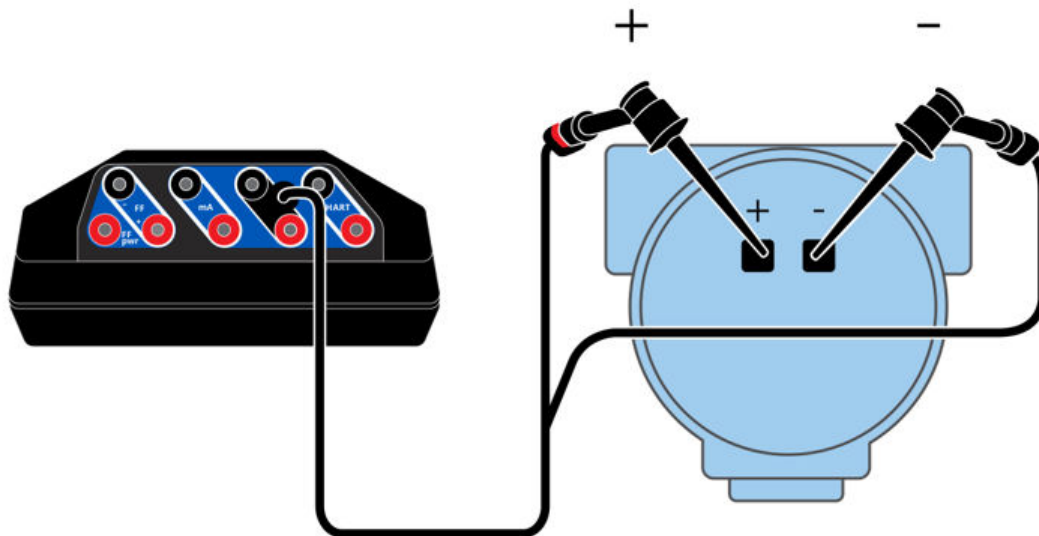
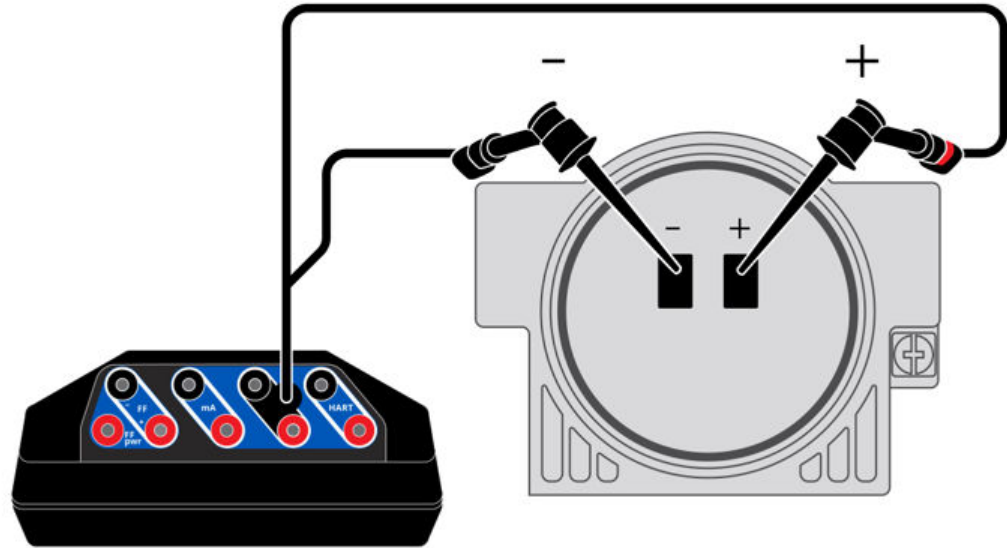


Figure 3-28: Power a HART positioner



2. In the Field Communicator application, tap **HART**.
3. Tap **Yes** when prompted if you want the Trex unit to power the device.
4. Tap **Transmitter** or **Positioner**.  
If you selected **Positioner**, the Trex unit provides power and 4 mA.
5. Follow any additional prompts.  
You may see additional prompts if the Trex unit cannot connect to the device. For example, you may be prompted to review the polling address. For a positioner, you may be asked to increase current (mA) to increase the value from the original 4 mA. The Online menu or the device dashboard displays, depending on the device type.

#### Related information

[Wiring diagrams for HART devices](#)

[Wiring diagrams for the Smart Wireless THUM Adapter](#)

[Disconnect a device](#)

[HART communication terminals](#)

[Internal resistors](#)

### 3.12.1 Power and connect to a Smart Wireless THUM adapter

The Trex unit must have the Device Communicator Plus communication module to power a THUM adapter.

When performing a bench configuration, the THUM adapter should be attached to a device. However, the Trex unit can power a THUM adapter when it is not connected to a HART device.

To connect to a device that has a THUM adapter attached, see [Connect to an externally-powered HART device](#) or [Power and connect to a HART device](#).

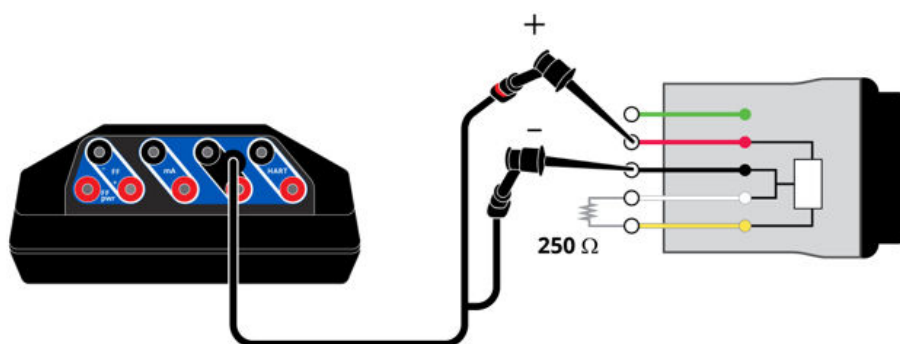
### ⚠ CAUTION

Remove the USB cable from the Trex unit before connecting to a device.

#### Procedure

1. Connect the lead set to the HART + pwr terminals on the Trex unit and the red/black wires on the THUM adapter.

**Figure 3-29: THUM adapter wiring with 250 Ohm resistor**



2. In the Field Communicator application, tap **HART**.
3. Tap **Yes** when prompted if you want the Trex unit to power the device.
4. Tap **Positioner**.
5. When prompted, change the polling address to 63.
6. Follow any additional prompts to connect to the THUM adapter. The device menu is displayed.

#### Related information

[HART communication terminals](#)

[Wiring diagrams for the Smart Wireless THUM Adapter](#)

[Disconnect a device](#)

## 3.13

### Connect to an externally-powered HART device

By default, the Trex unit tries to automatically connect to the device at address zero. See [Automatically connect to a HART device](#) for more information.


### ⚠ CAUTION

Remove the USB cable from the Trex unit before connecting to a device.

**Note**

The Trex unit acts as a secondary HART master on a HART loop.

**Procedure**

1. Connect the lead set to the HART terminals on the Trex unit and to the communication terminals on the device. See the HART wiring diagrams topic for the connection details.  
If you want to use the Trex internal resistor, connect the Trex unit in series with the device.
2. Open the Field Communicator application.  
The Trex unit may automatically detect or connect to the device.
3. If the Trex unit does not automatically connect to the device, tap **HART** and do the following:
  - a) Tap **No** when asked if you want to provide power from the Trex unit.
  - b) Select **Transmitter** or **Positioner**.
  - c) Follow any additional prompts.  
You may see additional prompts if the Trex unit cannot connect to the device. For example, you may be prompted to review the polling address if the device is not at address zero, or to increase loop resistance. The Online menu or the device dashboard displays, depending on the device type.
  - d) Tap the device displayed on the Device List.
4. To disconnect a device, tap the application menu  and tap **Disconnect**, or remove the lead set.

**Related information**

[Wiring diagrams for HART devices](#)

[Wiring diagrams for the Smart Wireless THUM Adapter](#)

[Disconnect a device](#)


[HART communication terminals](#)

[Internal resistors](#)




## 3.14 Online HART devices

### 3.14.1 HART icons

When the Trex unit communicates with a HART device, one of the following icons appears in the status bar at the top of the screen. The icon shows the status of the communication.

Icon	Description
	The Trex unit is communicating with a live, online HART device.



Icon	Description
	The Trex unit is communicating with a HART loop with a device in burst mode. Burst mode is a communication mode in a HART transmitter to send data at regular intervals.
	The Trex unit is running in shout/deaf mode, which helps it communicate with a device when it is on a noisy HART loop.
	The Trex unit is running in shout/deaf mode and communicating to a HART loop with a device in burst mode.

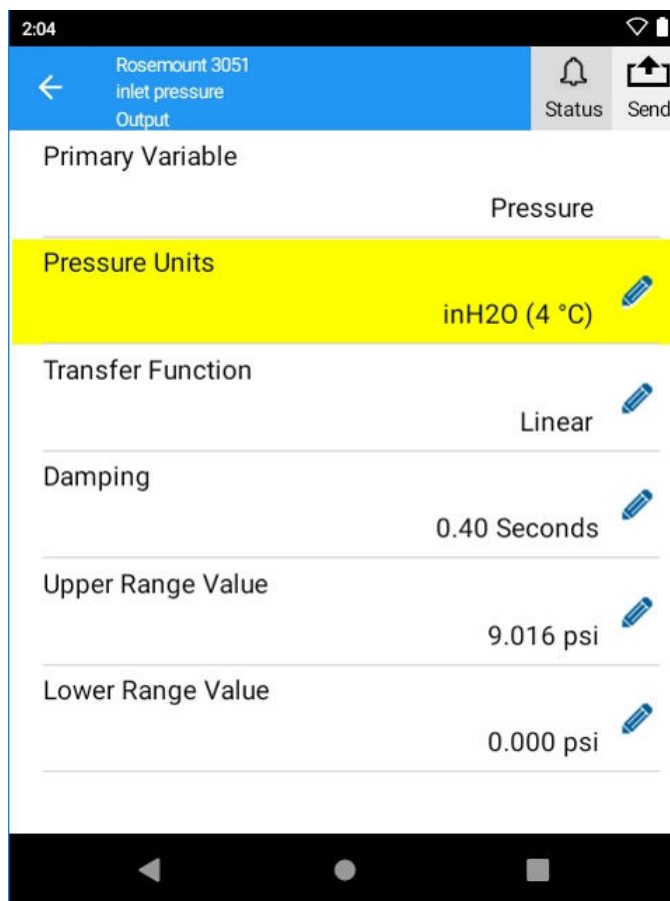
**Related information**

[Status bar](#)

### 3.14.2 Changing device parameters

When you change a parameter for a device, the Field Communicator application highlights the changed parameter yellow until you send the change to the device. You can send one or more changes to a device.

**Figure 3-30: Changed parameter is highlighted yellow**



### 3.14.3 Change a HART device parameter

You can modify one or more parameters and then send the changes to the device.

#### Procedure

1. Connect to the HART device.
2. Go to the parameter you want to change.  
See the device documentation for more information. Each device has different menus.
3. Make the desired change.  
The changed parameter is highlighted yellow.
4. Tap **OK**.
5. Tap the **Send** icon in the upper right corner.  
A list of all the changes you made is displayed.
6. Review the change.  
Tap **Discard** to undo the change and close the screen. Tap **Cancel** to keep the change and send it to the device at a later time.
7. Tap **Send**.  
The change is sent to the device. The yellow highlight is removed from the changed parameters.

### 3.14.4 Edit a HART configuration

#### Prerequisites


---

#### Note

Do not edit a configuration on the Trex unit while you are connected to the Configuration Management PC application.

---

#### Procedure

1. In the **Field Communicator** application, tap the menu  and tap **Disconnect**.
2. Tap Edit Existing.
3. Tap the column heading to sort configurations by File Name or Tag. Select the configuration you want to edit, and tap **OK**.
4. Select and edit the parameters.
5. Tap the checkbox to mark the parameter for writing.

#### Note

Unmarked parameters are saved but not sent when you transfer the configuration to a connected device.

---

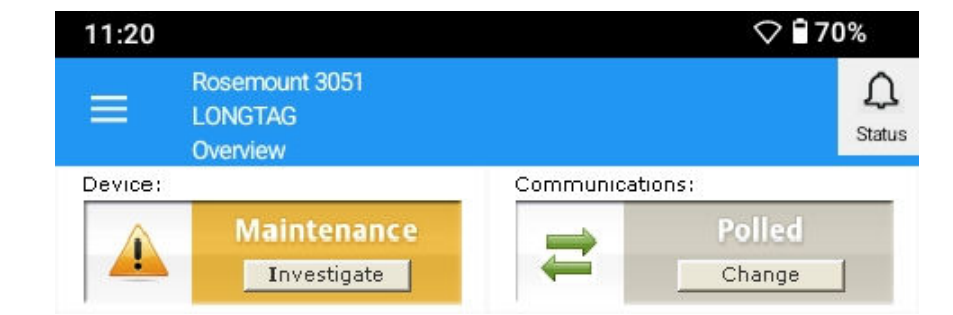
6. Tap **Save** when you finish editing the parameters.
7. If necessary, enter a new configuration name.
8. Tap **OK**.

## 3.14.5 View device status

### Procedure

1. Connect to a HART device.
2. If the device has a status update, tap **Status** at the top of the screen. The list of status messages is displayed.

**Figure 3-31: Status button**




3. Tap **OK**.

## 3.14.6 Send a configuration to a connected HART device

### Prerequisites

You must have at least one configuration saved in the Trex unit for the connected device type.


### Procedure

1. Connect to the HART device.
2. Tap the application menu , and tap **Send Configuration**.
3. Select a saved configuration, and tap **OK**.
4. Review the parameters, and tap **Send**.

## 3.14.7 Save a configuration from a HART device

You can save a copy of the configuration from the connected device. The configuration has only non-dynamic parameters.

### Procedure

1. Connect to the HART device.
2. Tap the application menu  and tap **Save Configuration**.
3. Enter a filename for the configuration, and tap **OK**. The configuration is saved in the Trex unit.

## 3.15 Offline HART configurations

The Trex unit lets you work with HART configurations. You can create, edit, copy, delete, and rename configurations.

If you are not connected to a HART device, an Offline option displays on the Field Communicator menu. You can edit and store a configuration on the Trex unit.

If you are connected to a HART device, you can either Save Config to the Trex unit, or Send Config to the connected device.

You can also back up the configurations to a PC by using the Configuration Management application. For more information, see the Help included with the Configuration Management application.

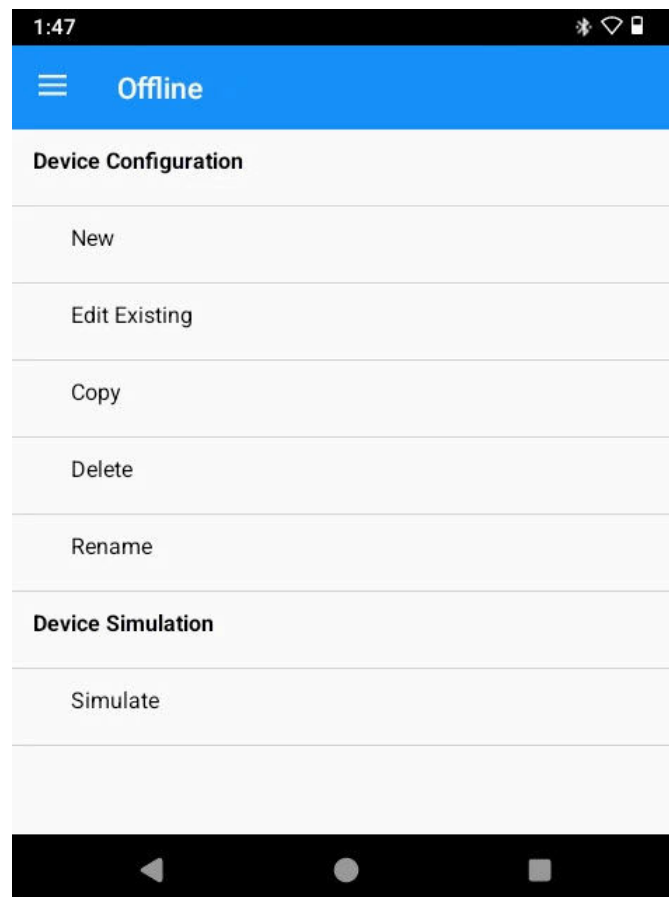
---

### Note

Do not edit a configuration on the Trex unit while you are connected to the Configuration Management PC application.

---


**Figure 3-32: Offline Screen**



## 3.15.1 Create a HART configuration

Create a new configuration for a specific device type and revision. You can then apply this configuration to multiple devices.

### Procedure

1. In the Field Communicator application, tap the application menu  and tap **Offline**.
2. Tap **New**.
3. You can either search by Manufacturer or Device, or expand Hart and scroll to device.
4. Tap a device. Tap a device revision.
5. Tap **OK**.
6. Select and edit the necessary parameters.
7. Tap **OK** to mark the parameter for writing.

---

#### Note

Unmarked parameters are saved but not sent when you transfer the configuration to a connected device.

---

8. Tap **Save** when you finish editing the parameters.
9. Enter a name for the configuration, and tap **OK**.  
The configuration file is saved.

## 3.15.2 Edit a HART configuration

### Prerequisites


---

#### Note

Do not edit a configuration on the Trex unit while you are connected to the Configuration Management PC application.

---

### Procedure

1. In the **Field Communicator** application, tap the menu  and tap **Disconnect**.
2. Tap **Edit Existing**.
3. Tap the column heading to sort configurations by File Name or Tag. Select the configuration you want to edit, and tap **OK**.
4. Select and edit the parameters.
5. Tap the checkbox to mark the parameter for writing.

---

#### Note

Unmarked parameters are saved but not sent when you transfer the configuration to a connected device.

---


6. Tap **Save** when you finish editing the parameters.

7. If necessary, enter a new configuration name.
8. Tap **OK**.

### 3.15.3 Copy a HART configuration


You can create a copy of a saved configuration.

#### Procedure

1. In the Field Communicator application, tap the application menu  and tap **Offline**.
2. Tap **Copy**.
3. Select the configuration you want to copy, and tap **OK**.
4. Enter a name for the new copy of the configuration, and tap **OK**.
5. Tap **OK** when asked if you want to copy the file.  
The configuration is copied and saved to the Trex unit.


### 3.15.4 Rename a HART configuration

#### Procedure

1. In the Field Communicator application, tap the menu  and select **Offline**.
2. Tap **Rename**.
3. Select the file to rename
4. Enter a new name for the configuration, and tap **OK**.
5. Tap **OK** when asked if you want to rename the configuration.  
The configuration is renamed.

### 3.15.5 Delete a HART configuration

#### Procedure

1. In the Field Communicator application, tap the application menu  and tap **Offline**.
2. Tap **Delete**.
3. Select the file to delete, and tap **OK**.
4. Tap **OK** when asked if you want to delete the file.  
The file is deleted.

## 3.16 Favorites

You can add the most commonly used HART menu items to a list of favorites for quick access. (This feature is similar to the favorites/bookmark feature in a web browser.) You can add menus (with submenus), methods, or variables to the favorites. The list of

favorites is specific to a device revision. It does not include items added from multiple types of devices.

If the device description for the device has predefined favorites, they are available from the **Favorites** screen. Also, some devices may include additional menu items in the favorites list.

### 3.16.1 Open a menu item from the favorites list

The Favorites option is supported for only HART devices.

#### Procedure

1. Connect to a HART device.
2. Tap **Menu** → **Favorites**.  
The Trex unit displays the list of favorites for the device.
3. Tap a saved favorite to open that menu item.

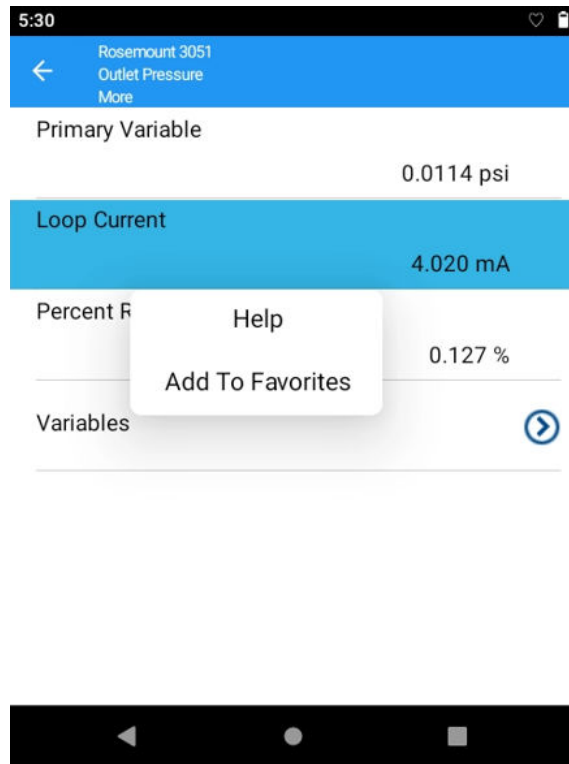
### 3.16.2 Add a menu item to the favorites list

Add a menu item for a HART device to the favorites for quick access.

#### Procedure

1. Connect to a HART device.
2. Go to the menu item you want to add to the favorites.
3. Press the menu item for 2 seconds.  
A menu appears.

Figure 3-33: Favorites menu



4. Tap **Add To Favorites**.  
The menu item is added to the favorites.

### 3.16.3 Remove a menu item from the favorites list

#### Note

Some devices have default options, such as tag or range values, already in the favorites list. You cannot remove these default options. You can only remove options you added to the favorites list.

#### Procedure

1. Connect to a HART device.
2. Tap **Menu** → **Favorites**.
3. Press and hold a menu item displayed in the Favorites list.
4. Tap **Remove From Favorites**.

## 3.17 Polling options for HART devices

The Field Communicator application uses the HART polling options to search for connected devices. By default, the Trex unit searches for a device at address zero and automatically connects to the device, if it is detected. Most HART device installations



contain one device per HART loop and the device address is zero. Multidrop mode is enabled by changing the address from zero to any address between 1 and 63. See the device documentation for more information about changing a device address.

If the Trex unit cannot find the device at address zero, the device connection wizard displays a message asking if you want to change the polling option.

The Trex unit can poll by:

- Address - Select an address (0-63).
- Tag - Enter the tag of the device.
- Long Tag - Enter the long tag of the device.

---

**Note**

If the Trex unit polls addresses greater than 15 on a loop with HART Universal Revision 5 devices, those devices may appear at multiple addresses.

---

**Note**

If you have two devices on a HART loop and one device is at address zero, disable the **Auto-Connect** option in the Trex Settings. Otherwise, the Trex unit automatically connects to the device at address zero and does not detect the second device.

---

### 3.17.1 Set the polling options for HART devices

When you connect to a device, the Trex unit by default automatically polls address zero and connects to the device at that address. If the Trex unit does not find a device at address zero, you are prompted to change the polling address in the device connection wizard.

If you change the polling option, the selected option is not saved. You need to select the desired option each time you connect to a device.

---

**Note**

If you have two devices on a HART loop and one device is at address zero, disable the **Auto-Connect** option in the Trex Settings. Otherwise, the Trex unit automatically connects to the device at address zero and does not detect the second device.

---

**Procedure**

1. Connect the lead set to the Trex unit and to the device.
2. Open the Field Communicator application.
3. If the Trex unit does not automatically connect to the device, tap **HART**.
4. Follow the prompts to connect to the device.
5. Tap **Yes** when prompted if you want to change the polling option.
6. Select a polling option at the top of the screen.

Option	Description
Address	<p>Poll for devices at the specified addresses.</p> <ul style="list-style-type: none"> <li>• <b>Address 0</b> : Poll non multi-dropped loops. This is the default option.</li> <li>• <b>Address Range 0 to 15</b> : Poll HART Universal Revision 5 or earlier devices on multi-dropped loops.</li> <li>• <b>Address Range 0 to 63</b> : Poll HART Universal Revision 6 or newer devices on multi-dropped loops.</li> <li>• <b>Address 63 (wireless adapter)</b> : Poll the default address for <i>WirelessHART</i> adapters.</li> <li>• <b>Address 0 and 63 (wireless adapter)</b> : Poll address 0 and the default address for <i>WirelessHART</i> adapters.</li> <li>• <b>Custom</b> : Poll a unique or non-consecutive group of addresses (example: "0, 5-7, 12"). Use a hyphen to specify consecutive addresses and/or a comma to separate numbers or groups of numbers.</li> </ul>
Tag	Poll by the tag of the device.
Long Tag	Poll by the long tag of the device. (Only supported in HART Universal Revision 6 or higher devices.)

## 3.18 Connections to FOUNDATION fieldbus devices

Connect the Trex unit to the device by using the lead set and the appropriate terminals. An error message appears if the lead set is connected incorrectly. Digital communication is susceptible to electrical noise; follow proper wiring instructions.

### Note

Dynamic variables shown while online represent the digital data being sent from the device.

### 3.18.1 Precautions for using the Trex unit with FOUNDATION fieldbus devices

#### **⚠ WARNING**

If a fieldbus segment is connected to a host system, the changes made with the Trex unit may not be recorded in the host system's permanent database. Verify the changes in the database. Otherwise, this could cause unpredictable results and, depending upon your application, process disruption leading to property damage, serious injury, or death. Ensure all safety precautions and work procedures have been followed.

**⚠ WARNING**

Changing device parameters could adversely affect the control of your process. Put the control loop in Manual/Out of Service before applying changes. Verify the output before returning the control loop to Auto. Failure to do so could result in property damage, serious injury, or death. Ensure all safety precautions and work procedures have been followed.

**⚠ CAUTION**

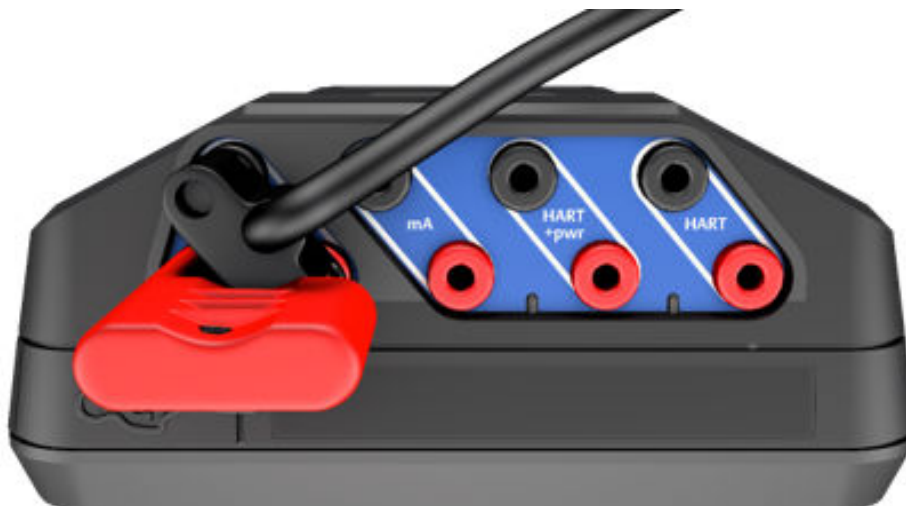
The Trex unit draws approximately 12 mA from the fieldbus segment when it is online. (The Trex unit draws 0 mA when it is offline.) Ensure the power supply or barrier on the fieldbus segment has the capacity to provide this additional current when the Trex unit is online. If a heavily loaded fieldbus segment is drawing near the capacity of the segment's power supply, connecting the Trex unit may result in loss of communication.

### 3.18.2 FOUNDATION fieldbus communication terminals

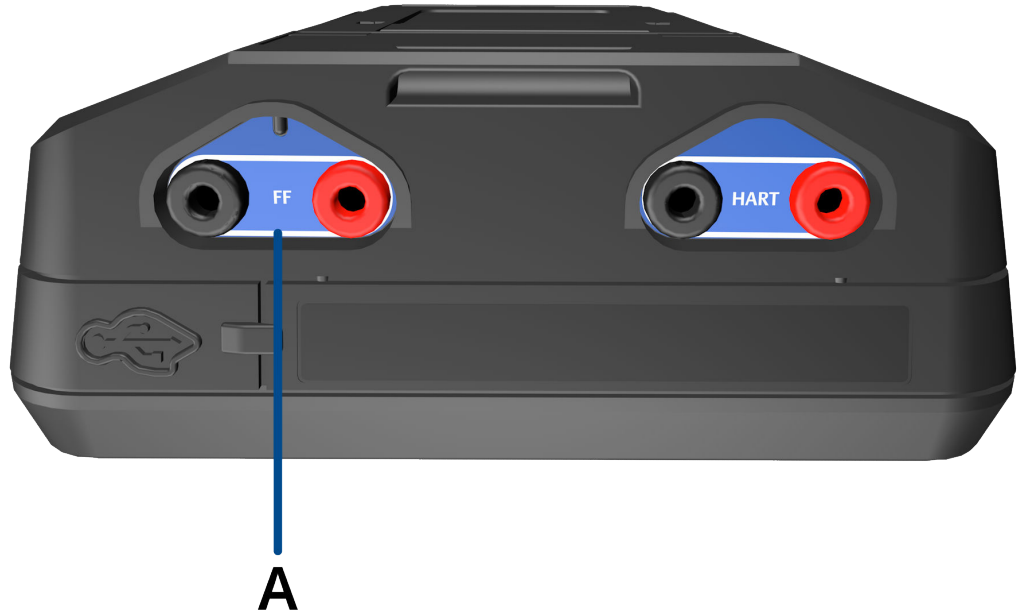
The Trex unit has terminals that enable communication with FOUNDATION fieldbus devices. Insert the lead set into the FF terminals and connect to a FOUNDATION fieldbus device or to a connection point on the fieldbus segment.

On the Device Communication Plus Module, the red **FF pwr** terminal enables the Trex unit to power one FOUNDATION fieldbus device. To use this terminal, you need the FOUNDATION fieldbus Power Plug that connects to the FF pwr terminal and the positive (red) FF terminal. This lets the Trex unit communicate with and power one FOUNDATION fieldbus device.

**Figure 3-34: FOUNDATION fieldbus Power Plug attached to the Trex unit**

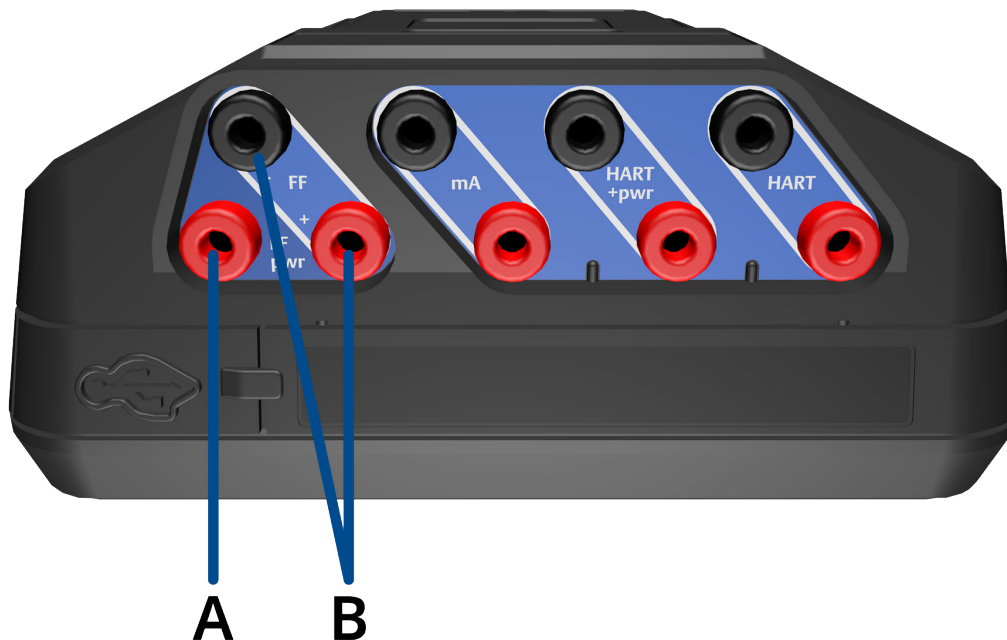


**Figure 3-35: FOUNDATION fieldbus terminals on the Device Communicator communication module**



*A. FF terminals to communicate with a FOUNDATION fieldbus device*

**Figure 3-36: FOUNDATION fieldbus terminals on the Device Communication Plus Module**



- A. FF pwr terminal provides power, power conditioning, and two terminators to one FOUNDATION fieldbus device. Use the FOUNDATION fieldbus Power Plug to connect this terminal to the red FF terminal.
- B. FF terminals to communicate with a FOUNDATION fieldbus device

#### Related information

[Wiring diagrams for FOUNDATION fieldbus devices](#)

### 3.18.3 Wiring diagrams for FOUNDATION fieldbus devices

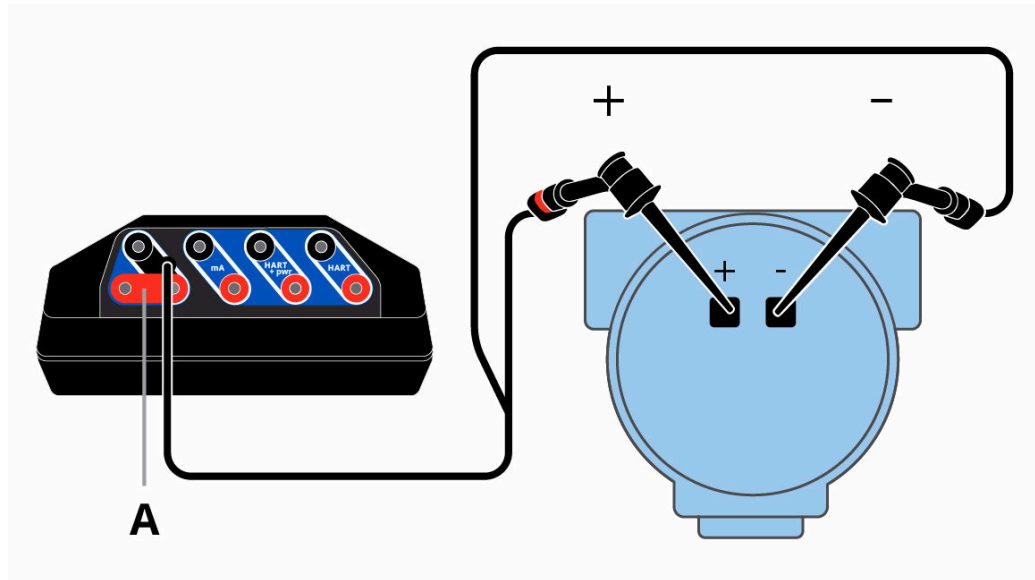
#### ⚠ CAUTION

Remove the USB cable from the Trex unit before connecting to a device.

#### ⚠ CAUTION

The Trex unit draws approximately 12 mA from the fieldbus segment when it is online. (The Trex unit draws 0 mA when it is offline.) Ensure the power supply or barrier on the fieldbus segment has the capacity to provide this additional current when the Trex unit is online. If a heavily loaded fieldbus segment is drawing near the capacity of the segment's power supply, connecting the Trex unit may result in loss of communication.

**Figure 3-37: Power and connect to a FOUNDATION fieldbus device**

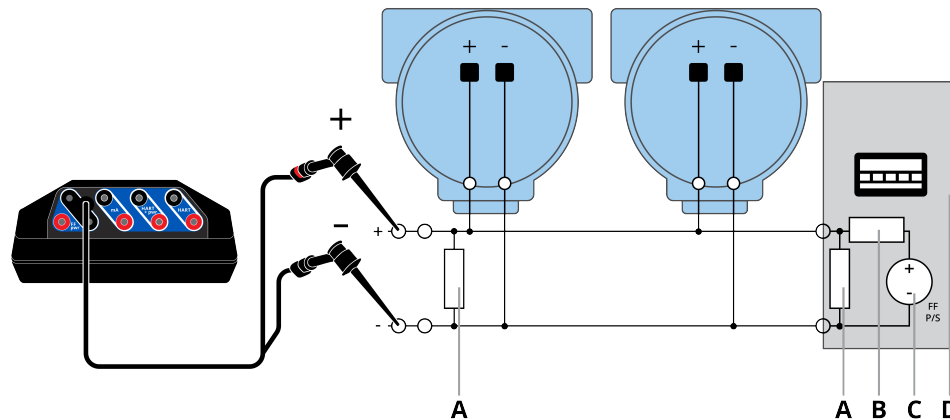


To power a FOUNDATION fieldbus device, the Trex unit needs the FOUNDATION fieldbus Power Plug. When the Trex unit powers a device, it also provides two terminators and a power conditioner.

**⚠ WARNING**

The Trex unit can power only one FOUNDATION fieldbus device.

A. FOUNDATION fieldbus Power Plug

**Figure 3-38: Connect to an externally-powered FOUNDATION fieldbus device**

For small fieldbus segments, the power conditioner and terminators can be contained in a single wiring block.

**Note**

You can connect the Trex unit at any convenient place along the fieldbus segment (bus). In the field, this is typically done at the device or at the fieldbus junction box. The drawing below is one example.

- A. Terminators
- B. Power conditioner
- C. Fieldbus power supply
- D. Host system

**Related information**

[FOUNDATION fieldbus communication terminals](#)

[Power and connect to a FOUNDATION fieldbus device](#)

[Connect to an externally-powered FOUNDATION fieldbus device](#)

### 3.18.4 Link Active Scheduler (LAS)

All fieldbus segments have only one Link Active Scheduler (LAS). The LAS operates as the bus arbiter for the segment. The Trex unit is the last node to become the LAS on a fieldbus segment.

The devices that can be the LAS are called link master devices. All other devices are called basic devices. Use the Trex unit to set a device to be a link master or basic device.

When a fieldbus segment first starts up, or upon failure of the existing LAS, the link master devices on the segment bid to become the LAS. The link master with the lowest address begins operating as the LAS immediately after completing the bidding process. Link masters that do not become the LAS can act as LAS backups by monitoring the fieldbus segment for failure of the LAS and then bidding to become the LAS when a LAS failure is detected.

Only one device can communicate at a time. Permission to communicate on the bus is controlled by a centralized token passed between devices by the LAS. Only the device with the token can communicate. The LAS maintains a list of all devices that need access to the bus. This list is called the Device List.

Although the Trex unit can be the LAS, it does not maintain the communication schedule and should not be thought of as a backup LAS. When the Trex unit is connected to a live fieldbus segment, it joins the fieldbus segment, but not as the LAS. The Trex unit can view and edit device parameters, but the LAS controls the segment.

The device acting as the LAS is labeled on the Device List screen.

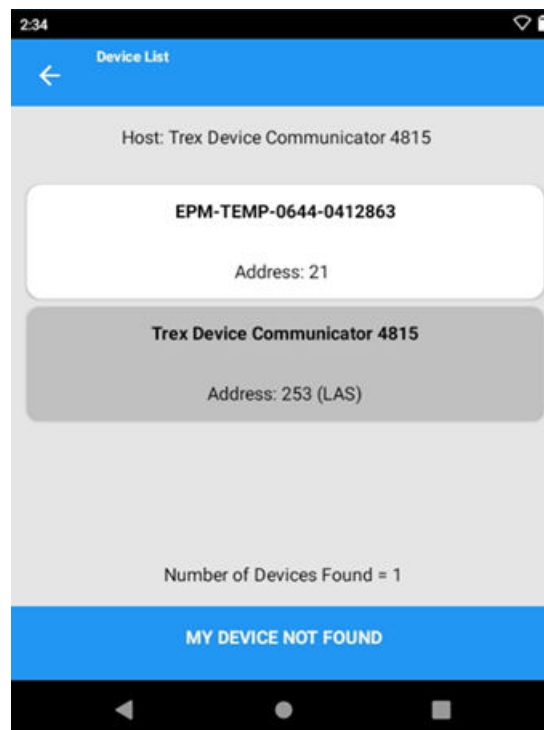
### 3.18.5 Fieldbus Device List

The Device List displays all devices that the Trex unit has detected. Each device is listed by its tag and address. The last four numbers of the Trex serial number are displayed to identify the Trex unit. The Device List also identifies the host on the fieldbus segment and which device is the LAS.

Tap a device listed on the screen to connect to it. If a device is not listed, tap **My Device Not Found**. This option expands the following settings:

- Polling addresses - By default, the Trex unit polls addresses 0-48 and 232-255. This range is then expanded to include all valid fieldbus addresses.
- Slot time - The slot time is increased to enable the Trex unit to find older FOUNDATION fieldbus devices on the fieldbus segment.

**Figure 3-39: Fieldbus Device List**





## 3.19 Power and connect to a FOUNDATION fieldbus device

The Trex unit can power one FOUNDATION fieldbus device. The Trex unit can provide approximately 10 volts at 25 mA to power a FOUNDATION fieldbus device. (The Trex unit will draw approximately 12 mA when it is online).

If you try to apply power from the Trex unit when the device is externally-powered, the Field Communicator application prevents the Trex unit from supplying power. This protects the Trex unit from damage.

---

### Note

When the Trex unit powers a FOUNDATION fieldbus device, two internal terminators and a power conditioner are applied. Ensure the device is not connected to a fieldbus segment, even if the segment is unpowered.

---

### ⚠ CAUTION

Remove the USB cable from the Trex unit before connecting to a device.

---

### ⚠ WARNING

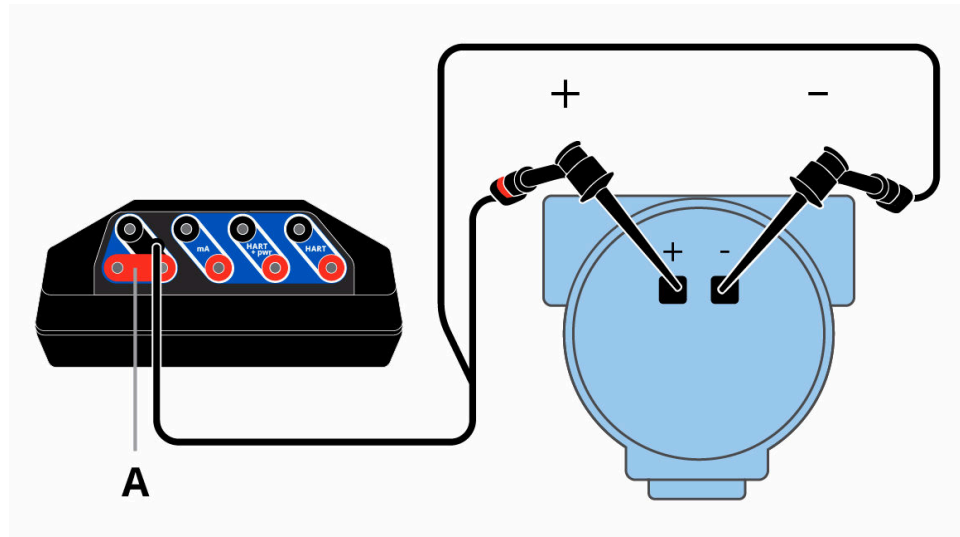
Do not add any external power to the device when the Trex unit is powering the device. This can blow a fuse inside the Trex unit. The repair/replacement will need to be completed at an authorized service center. Ensure the device is disconnected from the loop/segment and no other wires are connected to the device before providing power from the Trex unit.

---

### Procedure

1. Connect the lead set to the FF terminals on the Trex unit and directly to the communication terminals on the unpowered device. Ensure no other wires are connected to the device and there is no power to the device. Do not attach to a junction box.
2. Connect the FOUNDATION fieldbus Power Plug to the FF pwr terminal and the positive (red) terminal on the lead set.

**Figure 3-40: Connection for powering a FOUNDATION fieldbus device**



*A. FOUNDATION fieldbus Power Plug*

3. Open the Field Communicator application.
4. Tap **Fieldbus**.
5. Tap **Yes** when prompted if you want to provide power to the device from the Trex unit.  
The Trex unit provides power and searches for connected devices to display on the Device List.
6. From the **Device List**, tap the desired device.  
The Block List displays.
7. To stop powering the FOUNDATION fieldbus device, close the Field Communicator application or remove the lead set.

#### **Related information**

[Wiring diagrams for FOUNDATION fieldbus devices](#)

[Disconnect a device](#)

## **3.20**

### **Connect to an externally-powered FOUNDATION fieldbus device**

The Trex unit may automatically display the device on the Device List if the device is on a fieldbus segment that has a host system or a FOUNDATION fieldbus device that is the LAS.

The Trex unit will become the LAS if it is connected to an externally-powered FOUNDATION fieldbus device on a fieldbus segment with no communications.

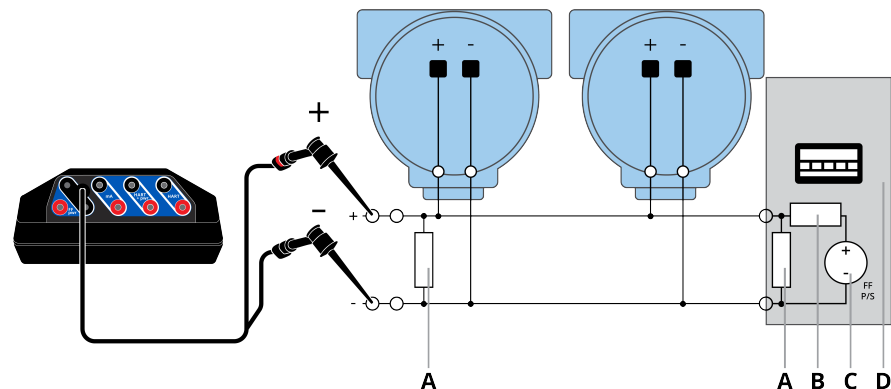
**⚠ CAUTION**

Remove the USB cable from the Trex unit before connecting to a device.

**Procedure**

1. Connect the lead set to the FF terminals on the Trex unit and the device.

**Figure 3-41: Example of connection to the fieldbus segment**



- A. Terminators
- B. Power conditioner
- C. Fieldbus power supply
- D. Host system

2. Open the Field Communicator application.
3. If the Trex unit does not automatically find the device, tap **Fieldbus** on the Connect - Select screen.
4. From the **Device List**, tap the desired device. The device menu is displayed.
5. To disconnect a device, tap **Menu** → **Disconnect**, or remove the lead set.

**Related information**

[Wiring diagrams for FOUNDATION fieldbus devices](#)

[Disconnect a device](#)

## 3.21 Online FOUNDATION fieldbus devices

### 3.21.1 Limitations for commissioned devices

The Trex unit prevents you from completing some tasks on commissioned devices that could adversely affect the control system. You cannot do the following on a commissioned device:

- Schedule blocks
- Change the link master configuration
- Change the block tag
- Change the device tag
- Change the device address

## 3.21.2 Device blocks

Many FOUNDATION fieldbus devices organize the device parameters into separate blocks. The Online menu displays block information for the connected FOUNDATION fieldbus device. Devices may have a resource and transducer block, and other device-specific blocks. (Other devices may display their parameters using a device dashboard.)

### Note

If you previously instantiated a block in a device, the Trex unit may not display that block. The Trex unit does not support block instantiation.

## Fieldbus block modes

The resource, transducer, and all function blocks in the device have modes of operation. These modes control the operation of the block. Every block supports both automatic (Auto) and out of service (OOS) modes. Other types of modes that may also be supported are Cas, RCas, ROut, IMan and LO.

You can change the mode by tapping the mode button that is displayed at the top of the screen. The mode button displays the fieldbus logo and lists the current mode for the block.

Mode	Description
Auto	The functions performed by the block will execute. If the block has any outputs, these will continue to update. This is typically the normal operating mode.
Out of Service (OOS)	The functions performed by the block will not execute. If the block has any outputs, these will typically not update and the status of any values passed to other blocks is "BAD". Before you change the configuration of the block, change the mode of the block to OOS. When the changes are complete, change the mode back to Auto.

## Mode parameters

Mode parameters change the block mode from one state to another. For example, you may want to change from **Auto** mode to **Out of Service**.

In the resource and transducer blocks, the mode parameters are often in the **Process** menu. In all other function blocks, the parameters are in the **Common Config** menu.

Mode	Description
Target	The mode that is assigned to a block and is used to change a block to a desired mode.


Mode	Description
Actual	The current mode of the block.
Permitted	The modes that are allowed for a block. Setting the Permitted modes prevents unauthorized changes to the operating mode of a block. To do this, configure the Block:Mode Permitted parameter to allow only the desired operating modes. It is recommended to always select OOS as one of the Permitted modes.
Normal	The mode that the block should be set to during normal operation conditions.

## Change the block mode for a FOUNDATION fieldbus device

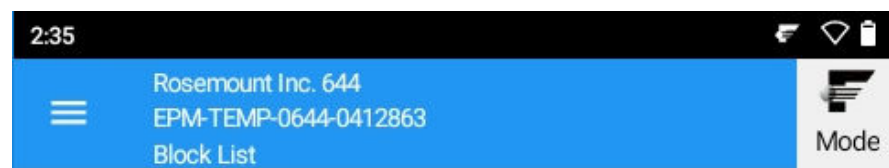
Whenever you need to change the parameters or properties of a block, change the mode.

You can change the mode for a block from the Block List, or you can open a specific block and change the mode.

### Procedure

1. Connect to a FOUNDATION fieldbus device.
2. To change the modes for one or more blocks on the Block List:
  - a) Tap the application menu  and select Block List.  
A list of all blocks and the selected modes is displayed.
  - b) For each block in the list you want to modify, select the block and select the desired mode.
  - c) Tap **OK**.
  - d) Tap **Send**.
  - e) Review the changes.
  - f) Tap **Send**.
3. To change the mode from within a block:
  - a) Go to a block menu in the device.

**Figure 3-42: Example Mode button in a block**



- b) Tap the mode button at the top of the screen.
- c) Select the desired mode for the block.
- d) Tap **OK**. The change is highlighted yellow.
- e) Tap **Send**.

- f) Review the change.
- g) Tap **Send**.


## Change the IO block schedule for FOUNDATION fieldbus devices

Change the IO block schedule on the bench (not connected to a control system) to execute an IO block to verify that the outputs of the block are computed correctly.

### Note

You cannot schedule IO blocks when the device is commissioned or a host/linking device is detected on the fieldbus segment. To schedule IO blocks, use the host system or remove the device from the fieldbus segment and connect it directly to the Trex unit.

### Procedure

1. Connect to the FOUNDATION fieldbus device.
2. Tap the application menu  and select Network.
3. Tap **Write IO Block Schedule**.
4. Tap **Yes** or **No** when asked if the device is commissioned.  
You cannot schedule blocks if the device is commissioned.
5. Select the appropriate macrocycle duration.
6. Select the appropriate IO blocks.
7. Tap **OK**.  
This schedules the blocks and sets the block mode to Auto.

## 3.21.3 Run a method

Different devices have different methods associated with them, and the selections on these menus vary accordingly. See the device documentation for more information on supported menu items.

### Procedure

1. Connect to the FOUNDATION fieldbus device.
2. Tap the desired block. (Typically, methods are run in the transducer block.)
3. Tap a menu containing methods. The menu options will vary for each device.
4. Tap the type of method you want to run, such as calibration or diagnostic. Follow the prompts on the screen to run the method.

## 3.21.4 View the device information

You can view the physical device tag, device address, device ID, and device revision.

### Note

The physical device tag and address of a device are read-only when the device is commissioned or a host/linking device is detected on the fieldbus segment. To change the

device tag or address, use the host system or remove the device from the fieldbus segment and connect it directly to the Trex unit.

### Procedure

1. Connect to the FOUNDATION fieldbus device.
2. Tap the application menu and select Network.
3. Tap one of the following options.

Option	Description
Physical Device Tag	The identifier for a device in the system.
Device Node Address	The data link layer node address of the device. The host control system can assign an address to a device when it is connected to a fieldbus segment.
Device ID	The unique identifier for a device.
Device Revision	The revision of the device.

## 3.21.5 Change a FOUNDATION fieldbus device parameter

You can change device parameters and then send the changes to the device.

When you select a parameter to change, you may be prompted if the device is commissioned. Some changes are prohibited for commissioned devices. You may also be prompted that the device will be disconnected from the application after you change the parameter.

### **⚠ WARNING**

Changing device parameters could adversely affect the control of your process. Put the control loop in Manual/Out of Service before applying changes. Verify the output before returning the control loop to Auto. Failure to do so could result in property damage, serious injury, or death. Ensure all safety precautions and work procedures have been followed.

### Procedure

1. Connect to the FOUNDATION fieldbus device.
2. Go to the parameter you want to change.  
See the device documentation for more information. Each device uses different menus.
3. If prompted, select if the device is commissioned.
4. Change the parameter.

#### Note

The Trex unit may disconnect from the device after you make the change. If this occurs, the change is automatically sent to the device without any additional input from you.

5. Tap **Send**.


6. Review the change.  
Tap **Discard** to undo the change and close the screen. Tap **Cancel** to keep the change and send it to the device at a later time.
7. Tap **Send**.
8. Tap **OK**.

## 3.21.6 Change the tag for a FOUNDATION fieldbus device

### Note

You cannot change the tag when the device is commissioned or a host/linking device is detected on the fieldbus segment. To change the tag, use the host system or remove the device from the fieldbus segment and connect it directly to the Trex unit.

### Procedure

1. Connect to the FOUNDATION fieldbus device.
2. Tap the application menu  and select Network.
3. Tap **Physical Device Tag**.
4. Select Non-commissioned device when asked if the device is commissioned and tap **OK**. You cannot make changes if the device is commissioned.
5. Tap **OK** when prompted that the device will be restarted after the parameter is changed.
6. Enter a new tag, and tap **OK**.  
The Trex unit disconnects from the device.
7. Tap **OK** on the message that indicates the device has been disconnected from the Trex unit.  
The **Device List** appears and displays the device with the new tag.
8. Tap the device to reconnect to it.

## 3.21.7 Guidelines for changing the device address

### Note

The physical address of a FOUNDATION fieldbus device is read-only when the device is commissioned or a host/linking device is detected on the fieldbus segment. To change the device address, use the host system or remove the device from the fieldbus segment and connect it directly to the Trex unit.

The host control system can assign an address to a device that is connected to a fieldbus segment. When you assign device addresses, follow the guidelines below:

- Addresses below 16 are not available.
- Addresses between 16 and 19 are usually reserved for host systems. A device should not be assigned in this address range.
- Valid device addresses are between 20 and 247.
- Addresses between 248 and 251 are temporary addresses. Devices without a tag or address appear on the fieldbus segment at these addresses.




- Addresses between 252 and 255 are reserved for visitors, such as the Trex unit.

### 3.21.8 Change the device address for a FOUNDATION fieldbus device

#### Note

The physical address of a FOUNDATION fieldbus device is read-only when the device is commissioned or a host/linking device is detected on the fieldbus segment. To change the device address, use the host system or remove the device from the fieldbus segment and connect it directly to the Trex unit.

#### Procedure

1. Connect to the FOUNDATION fieldbus device.
2. Tap the application menu  and select Network.
3. Tap **Device Node Address**.
4. Tap OK when prompted that the device will be restarted after the parameter is changed.
5. Select non-commissioned when asked if the device is commissioned. You cannot make changes if the device is commissioned.
6. Enter the new address, and tap **OK**. The Trex unit disconnects from the device.
7. Tap **OK** on the message that indicates the device has been disconnected from the Trex unit. The Device List appears and displays the device at the new address.
8. Tap the device to connect to it.

### 3.21.9 Polling for FOUNDATION fieldbus devices

When you connect the Trex unit to a FOUNDATION fieldbus device, the Field Communicator application polls the most common addresses for a fieldbus segment. You cannot set a specific range or a specific address. If the device is not detected, tap the **My Device Not Found** option to have the Field Communicator application automatically expand the polling range, if the Trex unit is the LAS. This option expands the following settings:

- Polling addresses - By default, the Trex unit polls addresses 0-48 and 232-255. This range is then expanded to include all valid fieldbus addresses.
- Slot time - The slot time is increased to enable the Trex unit to find older FOUNDATION fieldbus devices on the fieldbus segment.

### 3.21.10 Set a FOUNDATION fieldbus device to be a link master or basic device

If a device can be a Link Active Scheduler (LAS), the Link Master Configuration menu option displays in the menu. Select **Master** if you want the device to attempt to be the

LAS, or select **Basic** to prevent the device from becoming the LAS. After you set the option, the Trex unit disconnects from the device.

Setting the device as a link master does not set the device as the LAS. The link master device must follow the process to become the LAS if other link master devices are on the fieldbus segment.


---

**Note**

You cannot change the device to be a link master or basic device when a host/linking device is detected on the fieldbus segment. To change the device to be a link master or basic device, use the host system or remove the device from the fieldbus segment and connect it directly to the Trex unit.

---

**Procedure**

1. Connect to the FOUNDATION fieldbus device.
2. Tap the application menu  and select Network.
3. Tap **Link Master Configuration**.
4. Tap OK when prompted that the device will be restarted after the parameter is changed.
5. Select **Basic** or **Master**, and tap **OK**.
6. Tap **OK** to restart the device and apply the changes.  
The Trex unit displays the Device List.

## 3.22 Simulate a live device

You can simulate an online connection to a device without connecting to a device. Simulation mode is a training tool that helps you become familiar with devices before configuring them in a critical environment.


---

**Note**

Not all device descriptions have been optimized to run in simulation mode.

---


**Procedure**

1. In the Field Communicator application on the Connect - Select screen tap the application menu  and tap **Offline**.
2. Tap **Simulate**.
3. Tap a device manufacturer.
4. Tap the device type.
5. Tap the device revision.
6. Tap **OK** when the device information is displayed.  
The device menu is displayed. You can view the device menus and configure parameters.
7. To end simulation, tap the application menu and tap **Exit** or close the Field Communication application.

## 3.23 View the device descriptions on the Trex unit

You can view all the device descriptions that are installed on the Trex unit. The device descriptions are organized by the HART or FOUNDATION fieldbus protocol.

### Procedure

1. In the Field Communicator application, tap the application menu  and tap **Offline**.
2. Tap **Simulate**. You can either search for a device manufacturer or type by entering the manufacturer name or device type in the search bar or scroll by tapping the manufacturer or device type.
3. Select a device manufacturer.
4. Select a device type.  
The device revision and device description revision are displayed.
5. Tap the back arrow to return to the Offline menu.

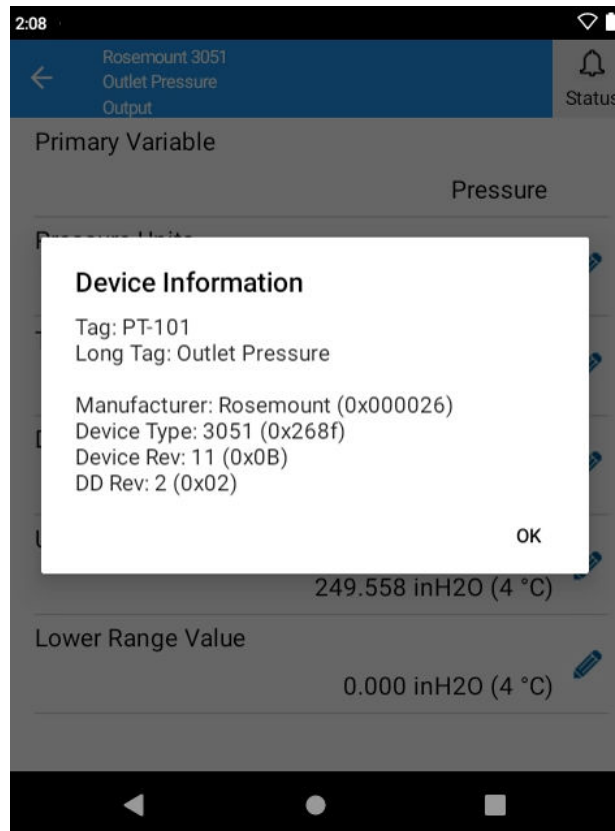
## 3.24 View the device description information

You can view information about the connected device, including the manufacturer, device type, device revision, and device description revision.

### Procedure

1. Connect to the HART or FOUNDATION fieldbus device.
2. Tap the tag that is displayed on the top of the screen.

Figure 3-43: Tap the device tag



3. Tap OK.

## 3.25 View Help for a device parameter

### Procedure

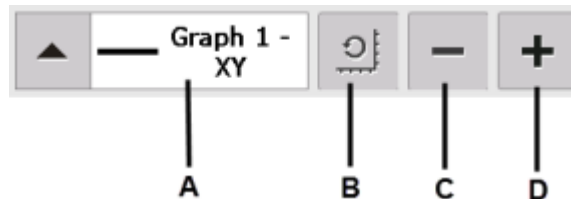
1. Go to the desired parameter in the connected device.
2. Press and hold the parameter.  
A menu appears.
3. Tap **Help**.  
The help text is displayed.
4. Tap **OK** to close the Help screen.

## 3.26 Graphics

The Electronic Device Description Language (EDDL) capabilities let the Trex unit display graphics for the connected devices. You can view HART or FOUNDATION fieldbus device information as images, charts, and graphs.

Each type of graphic lets you zoom in, zoom out, and reset the graphic. You can also use the drop down box to select a variable, if multiple variables are displayed.

**Figure 3-44: Graphics options**



- A. Select a variable. The selected variable is displayed with a bold line.
- B. Reset the zoom level.
- C. Zoom out
- D. Zoom in

### 3.26.1 Images

An image is a full-screen picture of a device. Images can include logos and various graphics, such as tanks. To view the image, select the image or drawing label in the menu. The full screen image is shown. To close the image, tap the back arrow.

Some images have links that let you run methods or view additional menus. If an image has a link, a button is displayed at the bottom of the screen.

### 3.26.2 Charts

Charts display a graphic view of variables as they occur over time. There are four types of charts:

Chart type	Description
Strip/sweep/scope	<p>Displays variable data with an x-axis of time.</p> <p>A strip chart continually updates the chart, scrolling from right to left.</p> <p>A sweep chart updates the window from left to right, and then updates the window from left to right again, overwriting the oldest data. A vertical line is used to separate the old and new data. When the data reaches the right edge of the screen, the data is then plotted from the left edge of the screen and the x-axis is updated.</p> <p>A scope chart updates the window from left to right. When the data reaches the right edge of the screen, the screen is cleared and the x-axis is updated.</p>
Horizontal bar	Displays data represented as bars from left to right.
Vertical bar	Displays data represented as bars from bottom to top.
Gauge	Displays a gauge chart, similar to an analog car speedometer.

**Note**

If a chart is displayed for an extended time period, the Trex unit may have decreased response time due to the large number of data points in the chart.

### 3.26.3 Strip/sweep/scope chart

The strip/sweep/scope chart formats device data into a line chart that displays device data over time. The labels and axis displayed are determined by the device manufacturer. Use the drop-down list to select the variable you want to highlight.

The selected variable is displayed as a bold, solid-colored line. Other variables that share the same source or same Y-axis appear as thin or dashed colored lines on the chart. The colors are determined by the device description and may vary between devices. A vertical line may be displayed in the chart to distinguish between the old and new data. The vertical line advances as new data is displayed.

The time shown on the x-axis starts at the time the chart starts. The chart update rate is determined by the device manufacturer. The default chart update rate is 1 second.

### 3.26.4 Horizontal bar charts

A horizontal bar chart formats device data into bars from left to right and varies with time. Use the drop-down list to select the variable you want to highlight. Additional horizontal bars may be present if more than one variable is defined for the option you selected in the drop-down list. The selected variable from the drop-down list is outlined in color and has a black dot at the end of it. The colors are determined by the device description and may vary between devices. The labels and axis displayed are determined by the device manufacturer.

The chart update rate is determined by the device manufacturer. The default chart update rate is 1 second.

### 3.26.5 Vertical bar charts

A vertical bar chart formats device data into bars from bottom to top and varies with time. Use the drop-down list to select the variable you want to highlight. Additional vertical bars may be present if more than one variable is defined for the option you selected in the drop-down menu. The selected variable from the drop-down list is outlined in color and has a black dot above it. The colors are determined by the device description and may vary between devices. The labels and axis displayed are determined by the device manufacturer.

The chart update rate is determined by the device manufacturer. The default chart update rate is 1 second.

### 3.26.6 Gauge charts

A gauge chart formats device data into a view similar to an analog car speedometer and plots device data varying with time. Use the drop-down list to select the variable you want to highlight. Additional gauge needles may be present if more than one variable is defined.

The selected variable from the drop-down list appears as a long, colored needle while the other variables appear as short, colored needles. The colors displayed are determined by the device description and may vary between devices. A gauge chart can have up to three variables. The labels and axis displayed are determined by the device manufacturer.

The chart update rate is determined by the device manufacturer. The default chart update rate is 1 second.

### 3.26.7 Graphs

A graph is a snapshot line drawing of device information. Use the drop-down list to select the variable you want to highlight. Additional variables may be present if more than one is defined for the option selected in the drop-down list.

The selected variable from the drop-down list appears as a bold, solid-colored line while the other variables with the same Y-axis appear as thin colored lines. The colors displayed are determined by the device description and may vary between devices. The labels and axis displayed are determined by the device manufacturer.

You may also see symbols such as circles on some variables. These show keypoints that indicate the important values on a graph. If more than seven variables are on the graph, “+” symbols are displayed for the keypoints.

## 3.27 Disconnect a device

### Prerequisites

Before you disconnect the Trex unit from a device, resolve any unsent data to the device.

### Procedure

Tap **Menu** → **Disconnect** or remove the lead set from the device or the Trex unit.

The Trex unit detects the loss of voltage or current and stops communicating with the device. If the Trex unit was powering the device, the Trex unit stops providing power when the lead set is removed. The **Connect - Select** screen is displayed.





## 4 Loop Diagnostics application

The Loop Diagnostics application helps you troubleshoot the wiring of a 4-20 mA current loop by measuring the current. The application can also power a transmitter or positioner to isolate the device from its current loop and to verify its operation.

---

### Note

The Trex unit needs the Device communication plus module to use the Loop Diagnostics application. You may also need a second lead set.

---

If you connect the Trex unit's HART terminals in series with an externally-powered loop, you can enable **Trex Unit Current** and have the Trex unit control current (similar to how a transmitter controls current). Controlling current lets you do the following:

- Verify the input module on a digital control system.
- Verify the cabling between the connection point and the input module on a digital control system.
- Move a positioner.

If the Trex unit is not connected to an externally-powered loop, you can enable **Trex Unit Power** to power one transmitter or positioner. This helps you isolate a problematic device from its current loop and verify its operation. Powering a device lets you do the following:

- Verify a transmitter in isolation by powering the device and measuring the output.
- Verify a positioner in isolation by powering and moving the positioner.
- Perform wiring continuity checks on cables where no power exists.

### WARNING

The Loop Diagnostics application is a generic tool that, if misused, can interfere with an operating HART loop or may damage the ammeter in the Device Communication Plus Module. Do not provide Trex power or current on a loop that is in operation. Do not provide external power directly across the Trex mA terminals because this may damage the ammeter.

---

### 4.1 Open or close the Loop Diagnostics application

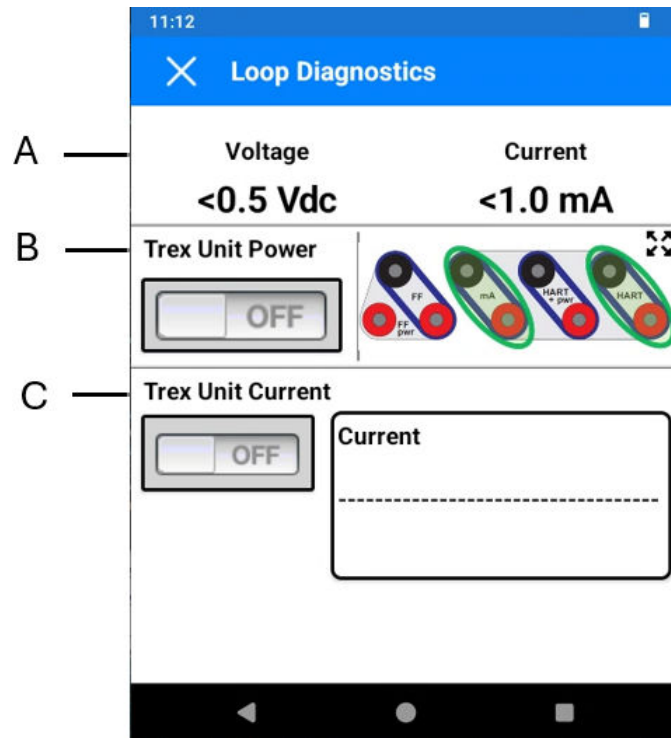
#### Procedure

1. To open the Loop Diagnostics application, tap the **Loop Diagnostics** icon on the Trex home screen.
2. To close the Loop Diagnostics application, tap **Exit**.  
If you enabled the Trex unit to power a device, the Trex unit stops providing power when you close Loop Diagnostics. If the Trex unit was powering a positioner, the application prompts you to select a current value for the positioner before the application closes. This allows you to move the positioner to a safe position. After the selected current value is reached, the Trex unit stops providing power.

## 4.2 Loop Diagnostics screen

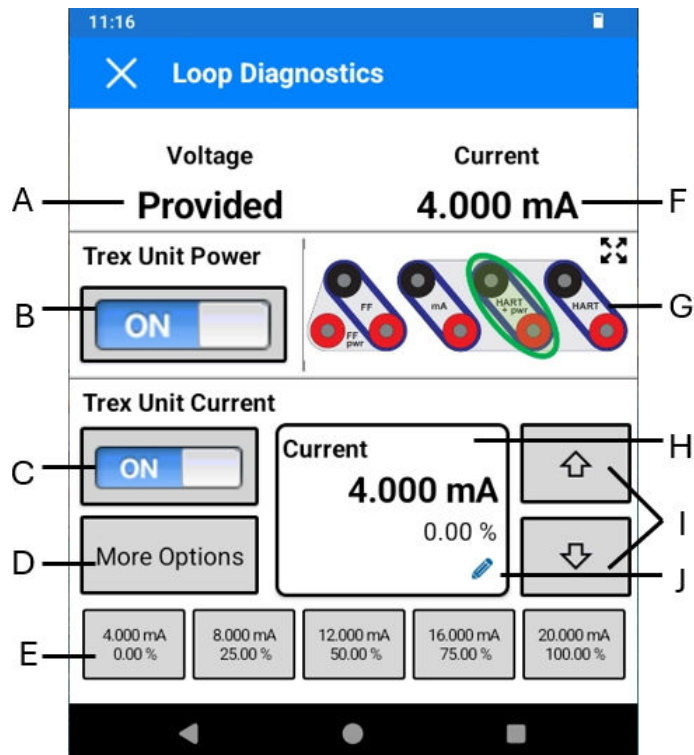
The Loop Diagnostics screen is divided into three sections:

Figure 4-1: Loop Diagnostics screen at start up



- A. **Measurement section:** Displays the measured current. The measurements begin when the **Loop Diagnostics** screen is displayed, and the measurements update about once per second. See [Voltage and current measurements in Loop Diagnostics](#) for more information about the terminals used for each measurement.
- B. **Power/Help section:** Allows you enable/disable the Trex unit to power a transmitter or positioner. The connection diagram on the right shows the terminals on the Trex unit where measurements are being read.  
By default, the HART and mA terminals are circled in green on the connection diagram. The diagram shows you one setup for reading voltage on the HART terminals and current on the mA terminals when **Trex Unit Power** is off. (This setup lets you take the measurements without interrupting the 4-20 mA current loop by connecting the Trex HART terminals to a transmitter's communication terminals and connecting the Trex mA terminals to a transmitter's test terminals.) The connection diagram is updated based on the options you select (**Trex Unit Power** and **Trex Unit Current**).
- C. **Current control/output section:** Provides multiple options for controlling current including quick buttons, keypad, and up/down keys for immediately adjusting current or for gradually changing current over 1 to 5 seconds. These options are displayed when either the **Trex Unit Power** or **Trex Unit Current** is ON.

Figure 4-2: Loop Diagnostics when powering a positioner and taking measurements



- A. Indicates Trex is providing voltage.
- B. Enable/disable the Trex unit to provide power to a transmitter or power and source current to a positioner. This lets you isolate a problematic device from its HART loop and verify its operation. Use the HART + pwr terminals on the Trex unit.
- C. Enable/disable the Trex unit to control current to an externally-powered positioner or to an analog input card on a digital control system. The Trex unit controls current the same way as a transmitter. Use the HART terminals on the Trex unit when the Trex Unit Power option is off. This option is automatically enabled if Trex Unit Power is on and the Trex unit is powering a positioner.
- D. Change the settings for supplying/controlling current, including the values of the quick buttons, the scale for the up and down arrows, and the time to change to a new current value. This option is enabled only when Trex Unit Power or Trex Unit Current is on.
- E. The quick buttons to control the current to the positioner or 4-20 mA current loop. You can change the values of the buttons from the More Options button.
- F. The current measured at the mA, HART + pwr, or HART terminals on the Trex unit. If Trex Unit Power is off and Trex Unit Current is on, use the HART terminals to measure current.
- G. The terminals that are controlling/measuring current are circled in green. Tap the image to see a larger version.
- H. The current that the Trex unit is supplying.
  - I. The up and down arrows to gradually increase or decrease the current. The default increment is 0.001 mA. You can change this increment from More Options.
  - J. Tap the pencil icon to enter a new current value to be supplied.

## 4.2.1 View the connection diagram as a full-screen image

The **Loop Diagnostics** screen displays an image of the terminals on the Trex unit to help you make the correct connection and to see where the measurements are read. The image changes to display the correct connection for a desired task, based on the measurements or options you selected. You can view a full-screen version of this image.

### Procedure

1. Tap the image of the terminals on the **Loop Diagnostics** screen.  
A larger image is displayed.
2. Tap **OK** to close the full-screen view, and return to the **Loop Diagnostics** screen.

## 4.3 Powering transmitters or positioners from Loop Diagnostics

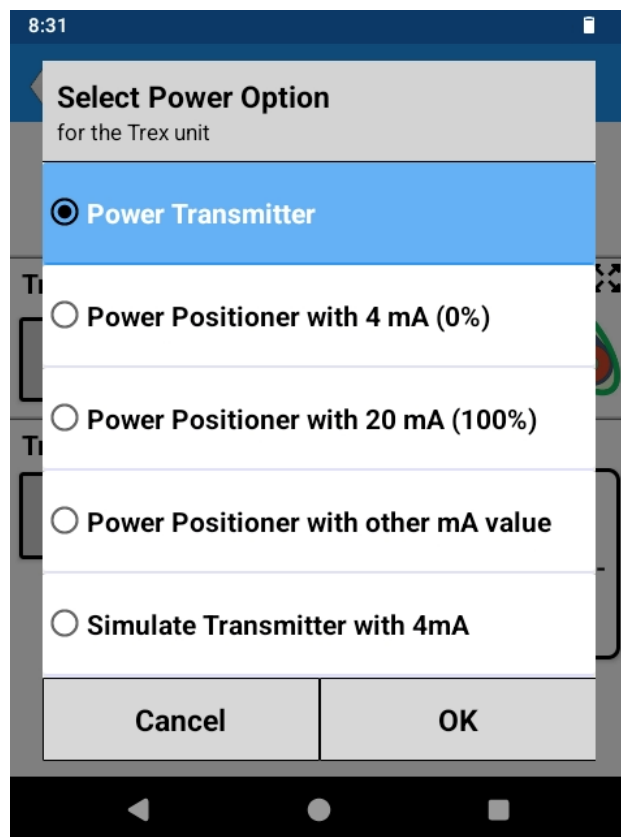
The **Trex Unit Power** option in the Loop Diagnostics application enables the Trex unit to power one transmitter or positioner in a bench setup. This lets you isolate a problematic device from its HART loop and verify its operation, or perform wiring continuity checks on cables where no power exists.

Use the HART + pwr terminals on the Trex unit to connect to the transmitter or positioner. When you tap the Trex Unit Power option, you can select the type of device (transmitter or positioner) to power.

The Trex unit notifies you if it measures voltage at the HART + pwr terminals when you try to turn on **Trex Unit Power**. If the measured voltage is less than 8 volts, the Loop Diagnostics application assumes that the voltage may be from the device, and you can select to ignore the low voltage and provide power from the Trex unit. If the voltage is greater than or equal to 8 volts, the Loop Diagnostics application will not let you enable **Trex Unit Power** to power a device.

The **Trex Unit Power** immediately turns off if the Loop Diagnostics application detects one of the following:

- A short circuit.
- The lead set is no longer connected to the device.
- A very high device-load that exceeds the capacity of the **Trex Unit Power** option.

**Figure 4-3: Select the type of device to power**

### Power a transmitter

The Trex unit can power one transmitter. When the Trex unit powers a transmitter, an internal 167 Ohm resistor is used, so an external resistor is not necessary. If you already connected an external resistor in series with the red or black HART terminal on the Trex unit, there will be less voltage available for the device, especially at 20 mA. This may cause the device to power off. The Trex unit begins providing power when you tap **OK**.

### **⚠ WARNING**

Do not insert a resistor in parallel with either the HART + pwr or HART terminals on the Trex unit or in parallel with the device's communication terminals. This will interfere with the current measurements.

### Power a positioner

The Trex unit can power one positioner and set the current to 4 mA, 20 mA, or another value between 3.5 and 22.5 mA. This allows you to set the position of the valve. The Trex unit begins providing power and current when you tap **OK**.

When the Trex unit provides power to a positioner, the **Trex Unit Current** option is also enabled. This allows you to control the current to the device by using the quick buttons, the pencil icon, or the up/down arrow keys.

### Simulate a transmitter with 4 mA

The Loop Diagnostics application lets you simulate a transmitter to verify an analog input loop before installing a device. This option is useful to perform a loop check on an analog input that will be wired to a 4-wire transmitter, or on an unpowered loop that has 2-wire devices. The Trex unit provides power and 4 mA to the current loop.

### Disable power to a device

To disable power, tap **Trex Unit Power** to set it to **OFF**. The Trex unit also stops providing power if you tap **Exit** or remove the lead set from the device or the Trex unit.

If the Trex unit is powering a positioner, it is recommended that you disable power by tapping **Trex Unit Power**. This allows you to move the positioner to a safe position without causing any unexpected moves from the valve when the Trex unit stops providing power. You can select 4 mA, 20 mA, or the present value. After the desired current level is reached, the Trex unit stops providing power.

---

#### Note

The Loop Diagnostics application has a **Duration of Current Change** option that lets you set how quickly the device will reach the set current level. If the **Duration of Current Change** option is not set to zero, the current changes gradually to the selected current. This is intended to protect large equipment from potential damage from abrupt movement.

---

## 4.4 Voltage and current measurements in Loop Diagnostics

The Trex unit can read voltage and measure current in several ways.

The voltage is read from the HART terminals on the Trex unit when **Trex Unit Power** is off, or from the HART + pwr terminals on the Trex unit when the **Trex Unit Power** is on.

The current measurements are taken at one of the following:

1. The mA terminals when the **Trex Unit Power** is off and **Trex Unit Current** is off. If a device has test terminals, you can measure current using the mA terminals on the Trex unit.
2. The HART terminals when the **Trex Unit Power** is off and **Trex Unit Current** is on.
3. The HART + pwr terminals when the **Trex Unit Power** is on and the Trex unit is powering a transmitter.
4. The HART + pwr terminals when the **Trex Unit Power** is on and the Trex unit is powering a positioner.

See [Wiring diagrams for the Loop Diagnostics application](#) for more information.

## 4.5 Wiring diagrams for the Loop Diagnostics application

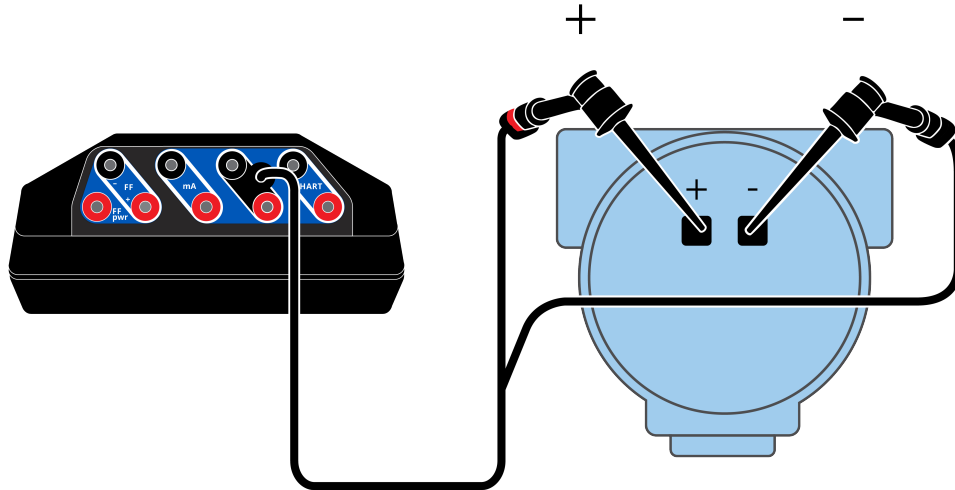
### ⚠ CAUTION

Remove the USB cable from the Trex unit before connecting to a device.

### ⚠ WARNING

- Do not connect lead sets to the HART and HART + pwr terminals at the same time. If the lead sets are connected to devices, this increases the chance of wiring mistakes and could create a short in the HART loop.
- Do not add any external power to the device when the Trex unit is powering the device. This can blow a fuse inside the Trex unit. The repair/replacement will need to be completed at an authorized service center. Ensure the device is disconnected from the loop/segment and no other wires are connected to the device before providing power from the Trex unit.
- The Trex unit cannot power a 4-wire device. Do not connect Trex unit to the power terminals of a 4-wire device. This can blow a fuse inside the Trex unit. The repair/replacement will need to be completed at an authorized service center.
- Do not connect the mA terminals (ammeter) in parallel with a powered 4-20 mA current loop. Ammeters have low resistance. This can disrupt the loop and cause devices to report incorrect values or positioners to move unexpectedly.
- Do not connect the mA terminals on the Trex unit to a power supply that is not current limited to 250 mA. This can blow a fuse inside the Trex unit. The repair/replacement will need to be completed at an authorized service center.

Figure 4-4: Power a HART transmitter

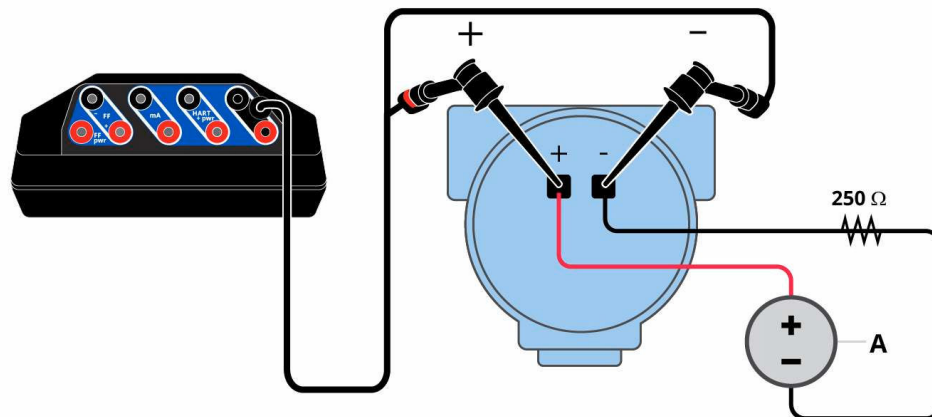


The Trex unit measures both voltage and current from the HART + pwr terminals. An internal 167 Ohm resistor is used when the Trex unit powers the device.

**⚠ CAUTION**

Do not insert a resistor in parallel with either the HART + pwr or HART terminals on the Trex unit, or in parallel with the device's communication terminals. This will interfere with the current measurements and may prevent communication.

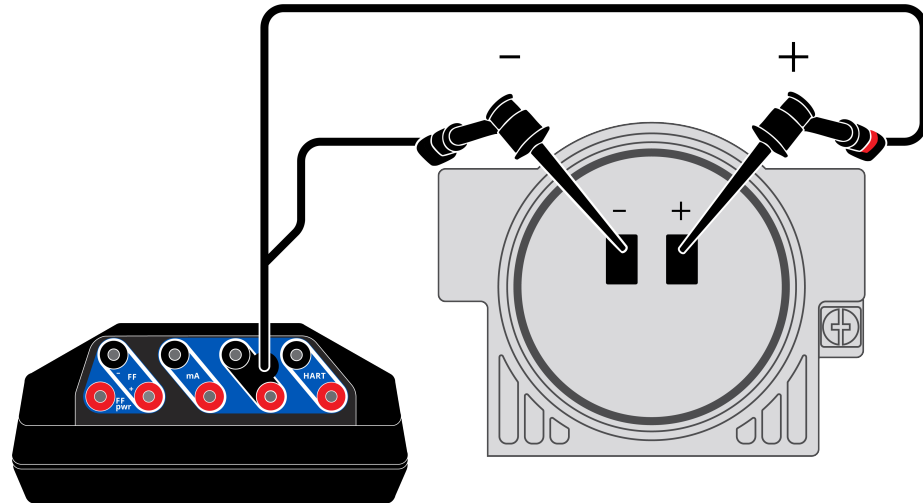
Figure 4-5: Measure voltage on an externally-powered HART transmitter



A. Voltage source - Use a voltage source with double insulation.

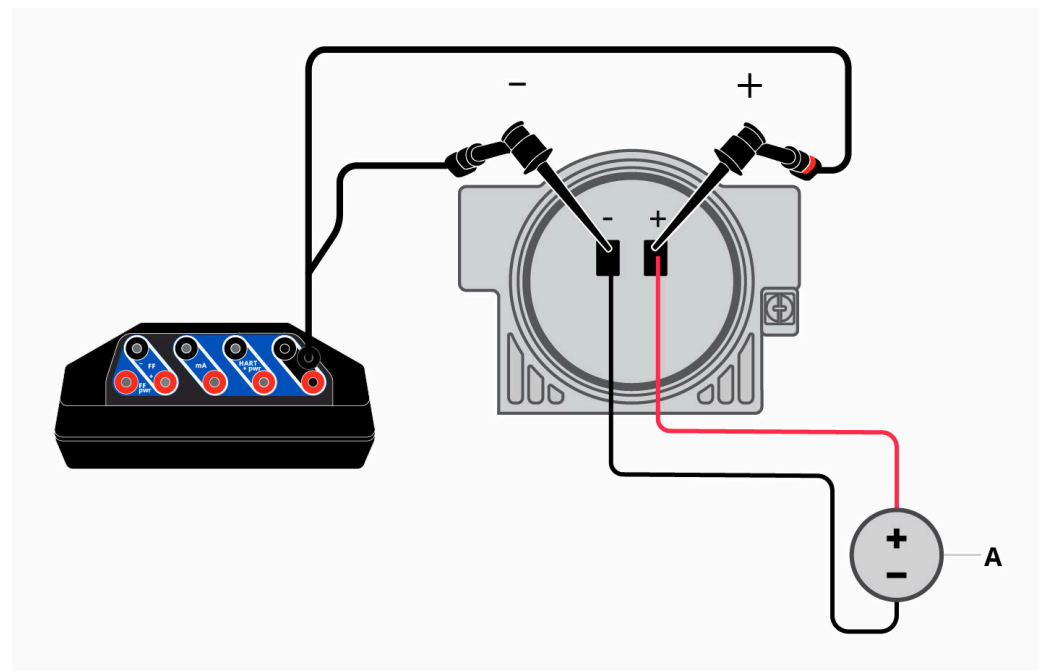


**Figure 4-6: Power and control current to a positioner**



The Trex unit measures both voltage and current from the HART + pwr terminals.

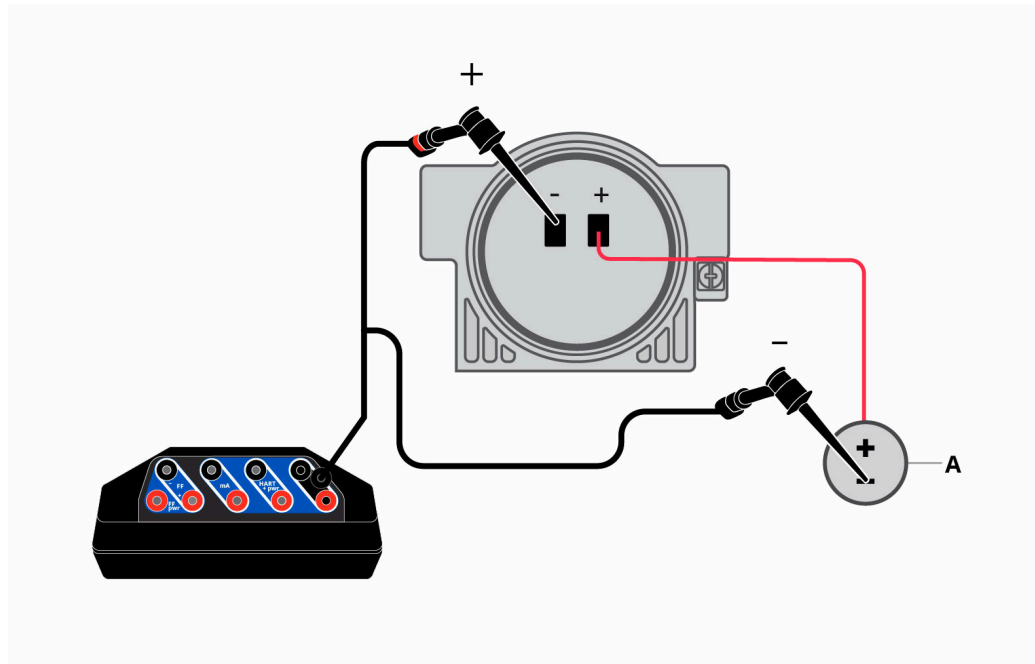
**Figure 4-7: Connect to an externally-powered positioner in-parallel**



The Trex unit measures voltage from the HART terminals. Voltage measurements can be taken at various points to identify voltage drops along the loop.

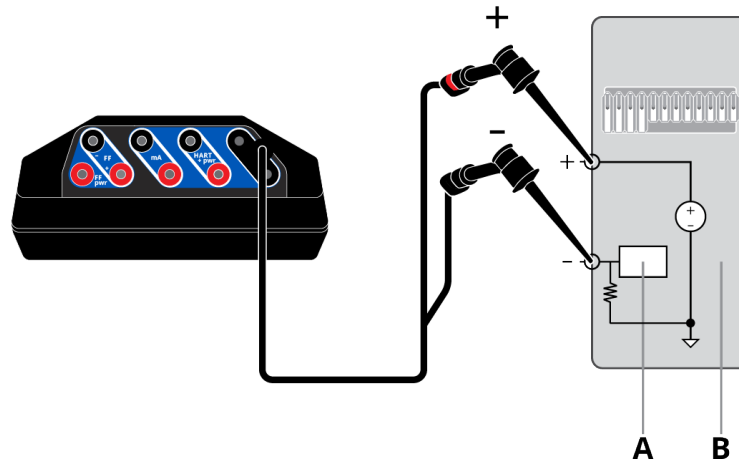
A. Current source

**Figure 4-8: Connect to an externally-powered positioner in-series**



The Trex unit controls current from the HART terminals.

*A. Voltage source - Use a voltage source with double insulation.*

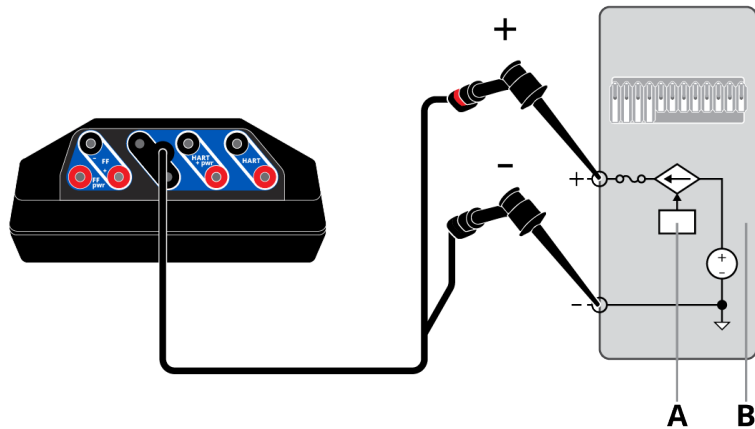
**Figure 4-9: Control current to simulate a transmitter on an externally-powered loop**

The Trex unit controls current from the HART terminals, which simulates a transmitter. The Trex unit controls current the same way as a transmitter controls current. The Trex unit is connected to the analog input (AI) channel.

You can connect the Trex unit at various points on the current loop, including a junction box, device connection point, etc.

- A. Analog input
- B. Host system

**Figure 4-10: Read current for an analog output loop check**



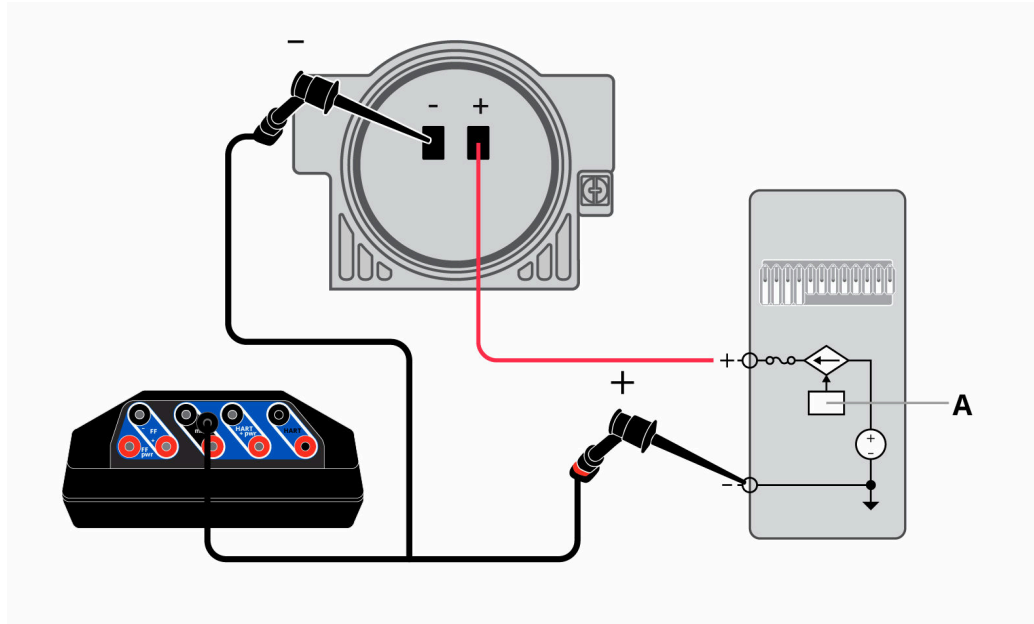
The Trex unit is connected to an analog output and is measuring current from the mA terminals. You can connect the Trex unit at various points on the current loop, including a junction box, device connection point, etc.

**⚠ WARNING**

Do not connect the mA terminals on the Trex unit to a power supply that is not current limited to 250 mA. This can blow a fuse inside the Trex unit. The repair/replacement will need to be completed at an authorized service center.

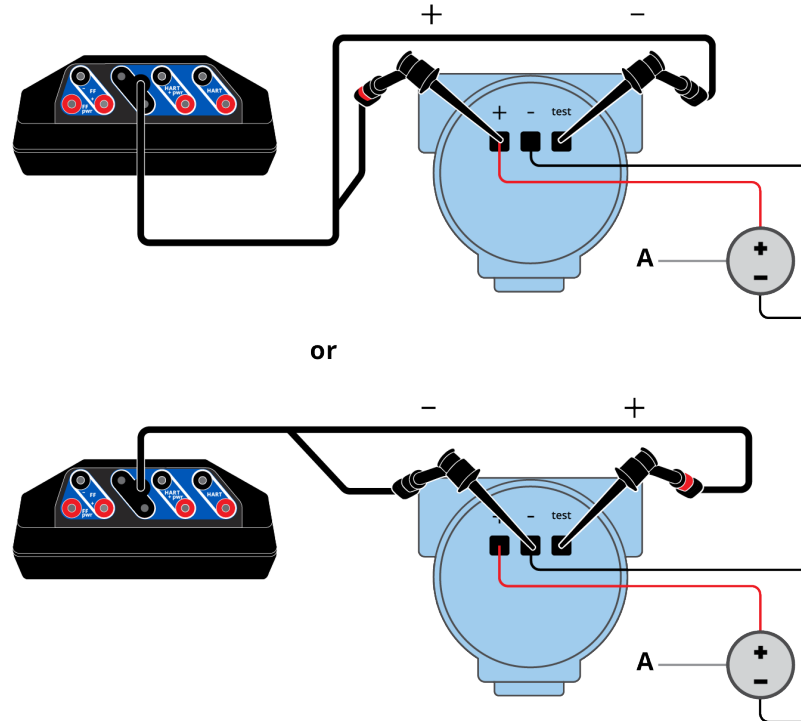
- A. Analog output
- B. Host system

Figure 4-11: Connect to an externally-powered positioner and read current



A. Analog output

**Figure 4-12: Measure current from an externally-powered transmitter device with test terminals**



The Trex unit measures current from the mA terminals on an externally-powered loop without breaking the loop and connecting the ammeter (mA terminals) in-series.

**⚠ WARNING**

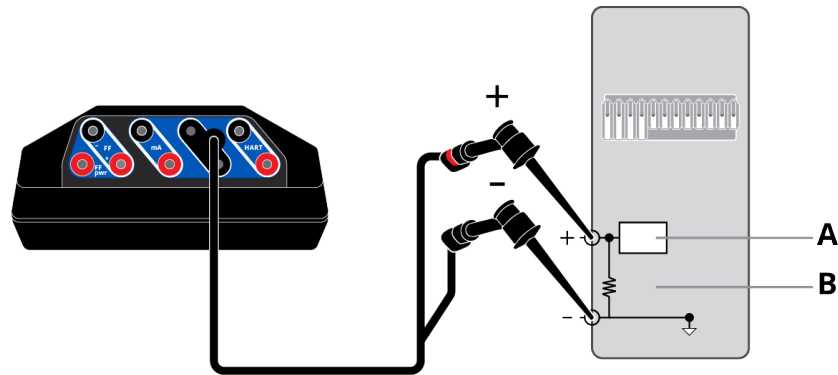
Do not insert a resistor in parallel with either the HART + pwr or HART terminals on the Trex unit, or in parallel with the device's communication terminals. This will interfere with the current measurements.

**Note**

Please review your device documentation for additional information about reading current from the test terminals. The orientation of the terminals on your device may be different. The drawing below is an example.

*A. Voltage source - Use a voltage source with double insulation.*

**Figure 4-13: Power and control current to simulate a transmitter on an unpowered loop**



**Note**

The Trex unit is connected to a 4-wire terminal block. Consult the host documentation for more information.

- A. Analog input
- B. Host system

## 4.6 Power a 2-wire transmitter

The Trex unit can provide up to 16 volts (at 22.5 mA) to power a HART device when using a Trex unit with a Device communication plus module. You do not need to add an external resistor. The Trex unit has a 167 Ohm internal resistor in the HART + pwr terminals that is used when the Trex unit provides power to the transmitter.

If you try to apply power from the Trex unit when the device is externally-powered, the Loop Diagnostics application prevents the Trex unit from supplying power. This protects the Trex unit from damage.

**⚠ CAUTION**

Remove the USB cable from the Trex unit before connecting to a device.

**⚠ CAUTION**

Do not add any external power to the device when the Trex unit is powering the device. This can blow a fuse inside the Trex unit. The repair/replacement will need to be completed at an authorized service center. Ensure the device is disconnected from the loop/segment and no other wires are connected to the device before providing power from the Trex unit.

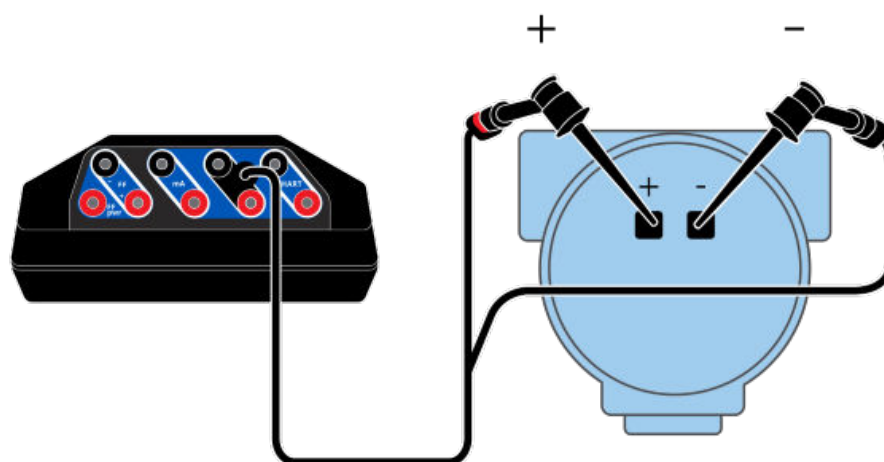
**Note**

Do not insert a resistor in parallel with either the HART + pwr or HART terminals on the Trex unit, or in parallel with the device's communication terminals. This will interfere with the current measurements and may prevent communication.

**Procedure**

1. Connect the lead set to the **HART + pwr** terminals on the Trex unit and to the transmitter.

**Figure 4-14: Power a 2-wire transmitter**



2. On the **Loop Diagnostics** screen, tap **Trex Unit Power**.
3. Tap **Power Transmitter**.  
The Trex unit uses an internal resistor while powering the device.
4. Tap **OK**.  
**Loop Diagnostics** is now powering the transmitter and measuring voltage and current.
5. To stop powering the device, do one of the following:
  - Tap **Trex Unit Power** to set the option to **Off**.
  - Tap **Exit**.
  - Remove the lead set from the Trex unit.

## 4.7 Power a 2-wire transmitter and measure analog output

You can remove a 2-wire HART transmitter from a loop, use the Trex unit to power the transmitter, and then measure the analog output.



If you try to apply power from the Trex unit when the device is externally-powered, the Loop Diagnostics application prevents the Trex unit from supplying power. This protects the Trex unit from damage.

### ⚠ CAUTION

Remove the USB cable from the Trex unit before connecting to a device.

### ⚠ CAUTION

Do not add any external power to the device when the Trex unit is powering the device. This can blow a fuse inside the Trex unit. The repair/replacement will need to be completed at an authorized service center. Ensure the device is disconnected from the loop/segment and no other wires are connected to the device before providing power from the Trex unit.

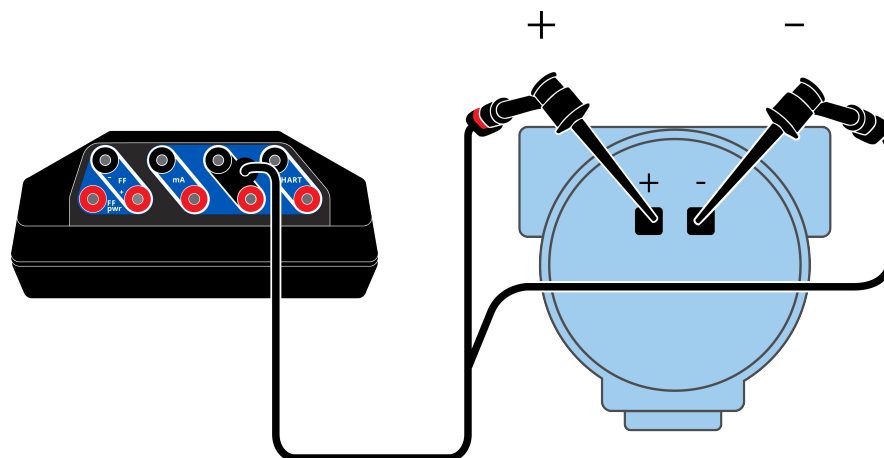
### Note

Do not insert a resistor in parallel with either the HART + pwr or HART terminals on the Trex unit, or in parallel with the device's communication terminals. This will interfere with the current measurements.

### Procedure

1. Connect the lead set to the **HART + pwr** terminals on the Trex unit and to the transmitter.

**Figure 4-15: Connection for providing power to the device**



2. On the **Loop Diagnostics** screen, tap **Trex Unit Power**.
3. Tap **Power Transmitter**.  
The Trex unit uses an internal resistor while powering the device.
4. Tap **OK**.

The Trex unit powers the device. The voltage and current measurements are displayed.

5. To stop powering the device, do one of the following:
  - Tap **Trex Unit Power** to set the option to **Off**.
  - Tap **Exit**.
  - Remove the lead set from the Trex unit.

## 4.8 Power a positioner

If you try to apply power from the Trex unit when the device is externally-powered, the Loop Diagnostics application prevents the Trex unit from supplying power. This protects the Trex unit from damage.

### **⚠ CAUTION**

Remove the USB cable from the Trex unit before connecting to a device.

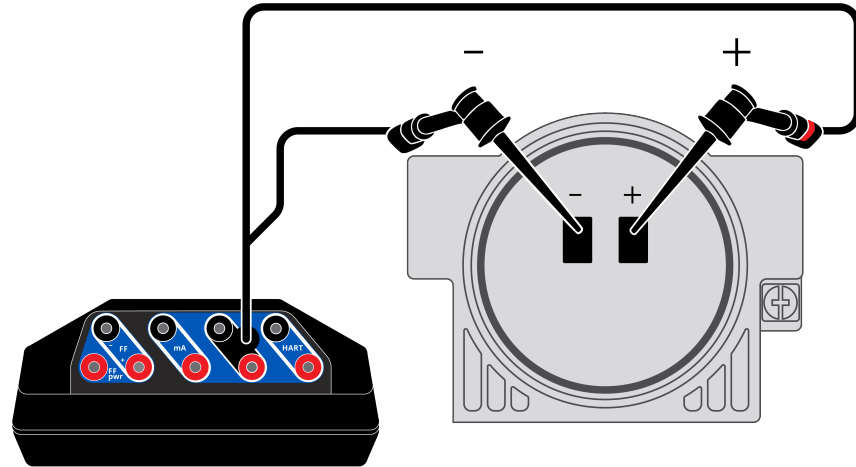
### **⚠ CAUTION**

Do not add any external power to the device when the Trex unit is powering the device. This can blow a fuse inside the Trex unit. The repair/replacement will need to be completed at an authorized service center. Ensure the device is disconnected from the loop/segment and no other wires are connected to the device before providing power from the Trex unit.

### **Procedure**

1. Connect the lead set to the **HART + pwr** terminals on the Trex unit and to the positioner.

Figure 4-16: Connection for powering a positioner



2. On the Loop Diagnostics screen, tap **Trex Unit Power**.
3. Select one of the following:

Option	Description
Power Positioner with 4 mA (0%)	Power a positioner using 4 mA.
Power Positioner with 20 mA (100%)	Power a positioner using 20 mA.
Power Positioner with other mA value	Power a positioner using a specified mA value.

4. Tap **OK**.  
**Loop Diagnostics** is now powering the positioner and measuring voltage and current. The **Trex Unit Current** option is also enabled.
5. To change the current value, tap one of the quick current buttons (4 mA, 8 mA, 12 mA, 16 mA, 20 mA), or use the up and down arrow keys to manually increase the current value. The default increment is 0.1 mA.
6. To stop powering the device, do one of the following:
  - Tap **Trex Unit Power** to set the option to **OFF**. You are prompted to select a power option to set the position of the valve.
  - Tap **Exit**. You are prompted to select a power option to set the position of the valve.
  - Remove the lead set from the Trex unit. You are **not** prompted to select a power option to set the position of the valve.

## 4.9 Stroke a valve

If you try to apply power from the Trex unit when the device is externally-powered, the Loop Diagnostics application prevents the Trex unit from supplying power. This protects the Trex unit from damage.

### ⚠ WARNING

Connecting power to the positioner may cause changes to the tuning set that cause the valve/actuator assembly to stroke. To avoid personal injury and property damage caused by moving parts, keep hands, tools, and other objects away from the valve/actuator assembly.

### ⚠ WARNING

When power is provided to a positioner that is in service, the valve may move causing process fluid or pressure to be released. To avoid personal injury and property damage caused by the release of process fluid or pressure, isolate the valve from the process and equalize pressure on both sides of the valve or bleed off the process fluid.

### Procedure

1. Connect the lead set to the **HART + pwr** terminals on the Trex unit and to the positioner.
2. On the Loop Diagnostics screen, tap **Trex Unit Power**.
3. Select one of the following options.

Option	Description
Power Positioner with 4 mA(0%)	Power a positioner with 4 mA.
Power Positioner with 20 mA (100%)	Power a positioner with 20 mA.
Power Positioner with other mA value	Power a positioner with a specified mA value.

4. Tap **OK**.
5. To change the current being supplied by the Trex unit, do one of the following:
  - Tap a quick current button.
  - Tap the up or down arrow keys to slowly increase or decrease the current. The default increment is 0.1 mA.
  - Tap the pencil icon to set a mA value.
6. Wait for the valve to move.
7. Repeat steps 5 and 6 until the valve moves through all the required positions.
8. To stop powering the device, do one of the following:
  - Tap **Trex Unit Power** to set the option to **OFF**. You are prompted to select a power option to set the position of the valve.

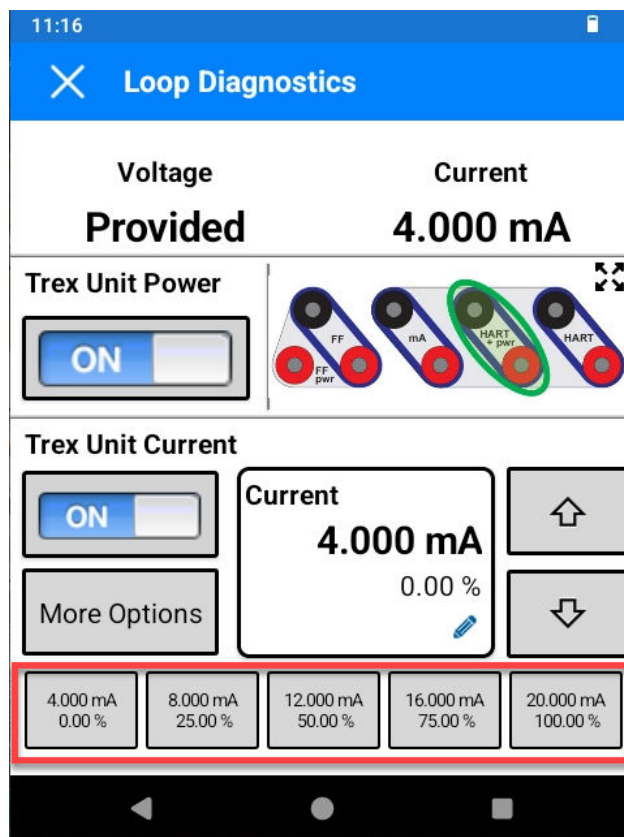
- Tap **Exit**. You are prompted to select a power option to set the position of the valve.
- Remove the lead set from the Trex unit. You are **not** prompted to select a power option to set the position of the valve.

## 4.10 Settings for controlling current

### 4.10.1 Change the values for the quick buttons

The **Loop Diagnostics** screen has five buttons that have default values of 4 mA, 8 mA, 12 mA, 16 mA, and 20 mA. These buttons let you quickly change the current. You can change the value for each button.

Figure 4-17: Quick buttons



#### Procedure

1. On the **Loop Diagnostics** screen, tap **Trex Unit Current** → **More Options** → **Quick Button Selection**.  
**More Options** does not appear unless the **Trex Unit Power** or **Trex Unit Current** is enabled.

2. Tap one of the **Quick Button Selection** options.
3. Enter a new value for the button, and tap **OK**.
4. Repeat until all buttons are set as desired.
5. Tap **Back** to save the changes and return to the **Loop Diagnostics** screen.

## 4.10.2 Change the scale for the up and down arrow keys

The **Loop Diagnostics** screen has up and down arrow keys that let you manually adjust the current in small increments to slowly move a valve. The default increment is 0.001 mA, but you can adjust the scaling.

### Procedure

1. On the **Loop Diagnostics** screen, tap **Trex Unit Current** → **More Options** → **Arrow Scaling for mA**.  
**More Options** does not appear unless the **Trex Unit Power** or **Trex Unit Current** is enabled.
2. Enter a value between 0.001 to 10.000 mA.
3. Tap **OK**.
4. Tap **Back** to save the changes and return to the **Loop Diagnostics** screen.

## 4.10.3 Set the duration to change the current

You can control how long it takes the Trex unit to change from sourcing one current value to another. Select a higher value to gradually change the current and avoid abrupt changes to a valve's position that may damage equipment. Select a value of zero to quickly move a valve.

This option applies to the quick current buttons, the up and down arrow keys, and the pencil icon that enable you to enter a new current value. It also applies when you tap **Trex Unit Power** to stop powering the positioner.

---

### Note

This option does not apply to the initial current value that is applied when you first power the device. For example, if you power a device, the **Loop Diagnostics** application will immediately source 4 mA, 20 mA, or the mA value you entered. The delay applies to any change to the current value after initial start up.

---

### Procedure

1. On the **Loop Diagnostics** screen, tap **Trex Unit Current** → **More Options** → **Duration of Current Change**.  
**More Options** does not appear unless the **Trex Unit Power** or **Trex Unit Current** is enabled.
2. Tap the desired number of seconds.
3. Tap **OK**.
4. Tap **Back** to save the changes and return to the **Loop Diagnostics** screen.

## 4.11 Loop checks

The Loop Diagnostics application enables loop checks by measuring current, and controlling the current to simulate a transmitter.

### Checks before installation

Before a device is installed, verify its operation. You can enable the Trex Unit Power option to power the device. For a transmitter, use the Trex unit to power the transmitter and measure the 4-20 mA output. For a positioner, use the Trex unit to power the positioner, control the current, and ensure the positioner moves as expected when the current changes.

### Checks during installation

You can use the Trex unit to verify a partially-installed loop. You can do the following:

- Connect the Trex HART terminals where the device will be installed. Verify the power supply voltage is measured, and that the voltage is large enough for a device. The measured voltage is for reference only.
- Connect the Trex HART terminals where a transmitter will be installed and enable **Trex Unit Current** to simulate a transmitter's 4-20 mA output. Verify the digital control system reads current from the Trex unit.
- Connect the Trex HART + pwr terminals where the power supply will be installed on a transmitter loop and enable **Trex Unit Power**. The Trex unit can measure the 4-20 mA output from the transmitter.
- Connect the Trex HART + pwr terminals where the power supply will be installed on a positioner loop and enable **Trex Unit Power**. Verify the device is powered and the voltage level is set by the positioner.
- Connect the Trex HART + pwr terminals where the device will be installed on an unpowered transmitter loop and enable **Trex Unit Power** to simulate a transmitter. Verify the digital control system reads output current from the Trex unit.
- Connect the Trex mA terminals at the location where a positioner will be installed. Verify the ammeter reads 4-20 mA when the digital control system output module is enabled.

### Checks after installation

Use the Field Communicator application on the Trex unit to verify the device is communicating.

For transmitters, use the Loop Diagnostics application to verify power and loop current. The HART terminals on the Trex unit can display voltage. Connect the HART terminals to the communication terminals on the device to ensure there is adequate voltage. To measure the current, connect the mA terminals to the test terminal on the device to measure the 4-20 mA output. If the device does not have a test terminal and the loop is removed from control, connect the mA terminals in series with the device's negative communication terminals to verify the 4-20 mA output.

For positioners, connect the HART terminals to the device's communication terminals to measure and verify there is adequate voltage. If you suspect a bad digital control system

output current, connect the mA terminals in series with the positioner's negative communication terminals to measure and verify the 4-20 mA output.

#### Troubleshoot a HART loop

- Attempt the tasks from the "Checks after installation" section.
- Simplify the problem by removing one or more components from the HART loop. Attempt tasks from the "Checks after installation" section.
- Isolate the device and perform tasks from "Checks before installation."

### 4.11.1 View voltage on an externally-powered loop

You can use the HART terminals on the Trex unit to view the voltage on an externally-powered device/loop.

#### Note

Use the HART + pwr terminals if you want the Trex unit to power the device and provide voltage. See [Power a 2-wire transmitter](#).

#### ⚠ CAUTION

Do not connect lead sets to the HART and HART + pwr terminals at the same time.

#### Procedure

1. Connect the lead set to the HART terminals on the Trex unit and to the externally-powered device.
2. View the **Voltage** section on the **Loop Diagnostics** screen. The voltage displayed is for reference only.

### 4.11.2 Measure the control system output

Measure loop current to ensure a device or distributed control system is sending the correct value. You can measure loop current from 0 to 25 mA on a 4-20 mA current loop.

#### Note

Measurements are for reference purposes only. Do not make critical process-control decisions based on these measurements.

#### ⚠ WARNING

Do not connect the mA terminals on the Trex unit to a power supply that is not current limited to 250 mA. This can blow a fuse inside the Trex unit. The repair/replacement will need to be completed at an authorized service center.

#### ⚠ WARNING

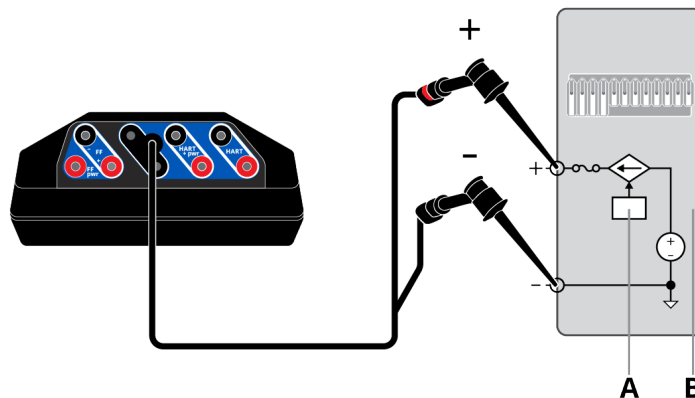
Do not connect the mA terminals (ammeter) in parallel with a powered 4-20 mA current loop. Ammeters have low resistance. This can disrupt the loop and cause devices to report incorrect values or positioners to move unexpectedly.



### Procedure

1. Connect the lead set to the **mA** terminals on the Trex unit and to a connection point on the loop.  
The Trex unit can be connected at various point along the loop to measure current.

**Figure 4-18: Example connection for measuring current**



- A. Analog output.  
B. Host system.

2. In the **Loop Diagnostics** application, view the measured current at the top of the screen.

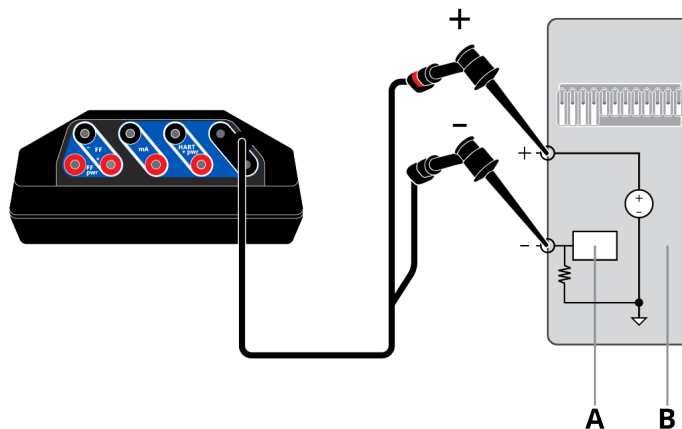
## 4.11.3 Simulate a transmitter on an externally-powered loop for a loop check

The Loop Diagnostics application can control current to simulate a 2-wire transmitter on an externally-powered loop. In this setup, the digital control system is powering the current loop and the Trex unit is controlling the current that is input into the digital control system.

### Procedure

1. Connect the lead set to the **HART** terminals on the Trex unit and to the powered 4-20 mA current loop.

Figure 4-19: Connection for controlling current



- A. Analog input.
- B. Host system.

2. On the Loop Diagnostics screen, tap **Trex Unit Current**.
3. Tap one of the quick buttons to increase the current being supplied, use the up and down arrow keys, or tap the pencil icon to enter a new value.
4. Verify the digital control system is reading the same current value.

#### 4.11.4 Simulate a transmitter on an unpowered loop for a loop check

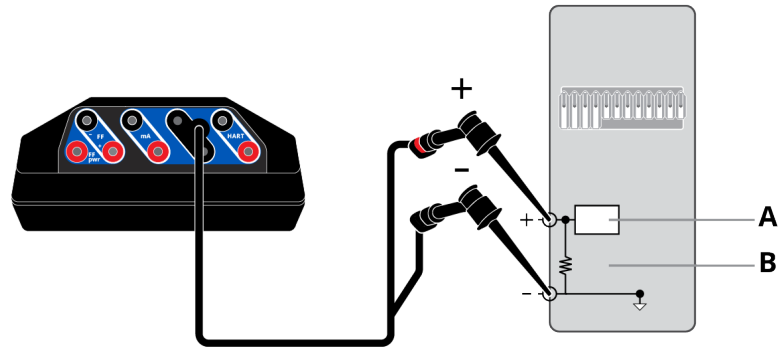
The Trex unit can provide power and control current to simulate a device for a loop check. In this setup, the control system is not providing power to the device. This task is used if the loop will have a 4-wire transmitter.

The Trex unit supplies loop power from the HART + pwr terminals, and Loop Diagnostics lets you control the current on the loop.

##### Procedure

1. Connect the lead set to the **HART + pwr** terminals on the Trex unit and to the unpowered loop.

---

**Figure 4-20: Connection for providing power and simulating a transmitter**

- A. Analog input.  
B. Host system.
- 

2. On the Loop Diagnostics screen, tap **Trex Unit Power**.
3. Tap **Simulate Transmitter with 4 mA**.
4. Change the current value by pressing the quick buttons or the up and down arrow keys.
5. Verify the digital control system is reading the same current value.



## 5 Fieldbus Diagnostics application

The Fieldbus Diagnostics application lets you run diagnostics to troubleshoot fieldbus segments and devices. It provides power and basic communications for verifying device operations on an isolated mini-segment. The application provides optional communications for identifying the device list. You can connect the Trex unit at various points along the fieldbus segment, so you can isolate the location of a problem.

The Fieldbus Diagnostics application can help you identify problems caused by loose wire connections, water or moisture in cables or terminal housings, improper grounding, or issues with fieldbus segment installations.

---

### Note

The Fieldbus Diagnostics application can be used with the Device Communication Module or Device Communication Plus Module. However, the Trex unit cannot power a FOUNDATION fieldbus device with the Device Communication Module. The application also requires a fieldbus license.

---

### Measurements

The Fieldbus Diagnostics application lets you measure:

- DC voltage: -34 to 34 volts
- Noise: Low-frequency (870 Hz - 9 KHz), in-band frequency (9 KHz - 39 KHz), and high-frequency noise (39 KHz - 100 KHz)
- Fieldbus signal level: 100 - 1200 mV (peak-to-peak)

### Quick ad-hoc network tests to isolate issues

You can use the Trex unit to connect to various connection points on the fieldbus segment to isolate an issue. For example, if the device fails to power due to a low-voltage at its terminals, use the Fieldbus Diagnostics application to measure the voltage at all cable connection points between the power supply and the device. These measurements can help you identify the section of cable or junction box where the voltage drop occurs.

### Long-term tests to catch sporadic issues

If a device has issues for only part of the day, you can take measurements over a period of time to capture the time/date the issue occurs. For example, if you notice sporadic increases in noise, you can take a measurement for multiple hours to determine when the issue is occurring. This can help you relate the noise with another event, such as a variable-frequency drive starting and stopping throughout the day.


### Periodic tests to help you track your network and create trends

You can take measurements every few months to create an overall trend/report for the fieldbus segment. For example, you can create one set of measurements when a device is installed, and another set of measurements a year later for comparison. This can help you track any slow degradation of the fieldbus segment.

The Fieldbus Diagnostics application has a logging feature that lets you save one or more sets of measurements to a comma-separated values (.csv) log file. The files can then be transferred to a PC for further review and analysis in a spreadsheet program.

## 5.1 Open or close the Fieldbus Diagnostics application

### Procedure

1. To open, tap the Fieldbus Diagnostics  icon on the Trex **Home** screen.
2. To close, tap **X**.

## 5.2 Fieldbus Diagnostics Overview screen

The **Fieldbus Diagnostics Overview** screen is the home screen for the application. The screen displays the status of the measurements and lets you configure the application.

---

### Note

The **Power supply** option is not displayed if the Trex unit has the Device Communication Module. The Device Communication Plus Module and FOUNDATION fieldbus Power Plug are required to power a FOUNDATION fieldbus device.

---

The measurements are labeled with a status of **GOOD**, **BAD**, or **CHECK**. You can configure the measurement criteria and ranges for the **GOOD** and **BAD** status labels. The **INACTIVE** status is displayed when there is no fieldbus signal, due to no device communication on the fieldbus segment. Review the measurement criteria in **Settings** to ensure they are appropriate for your installation.

Figure 5-1: Fieldbus Diagnostics screen at start up

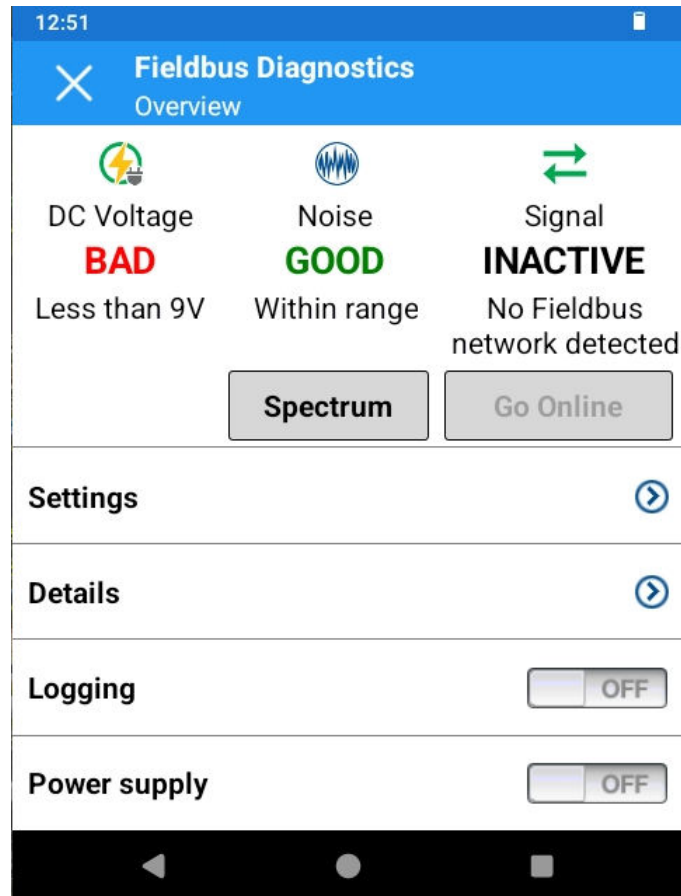
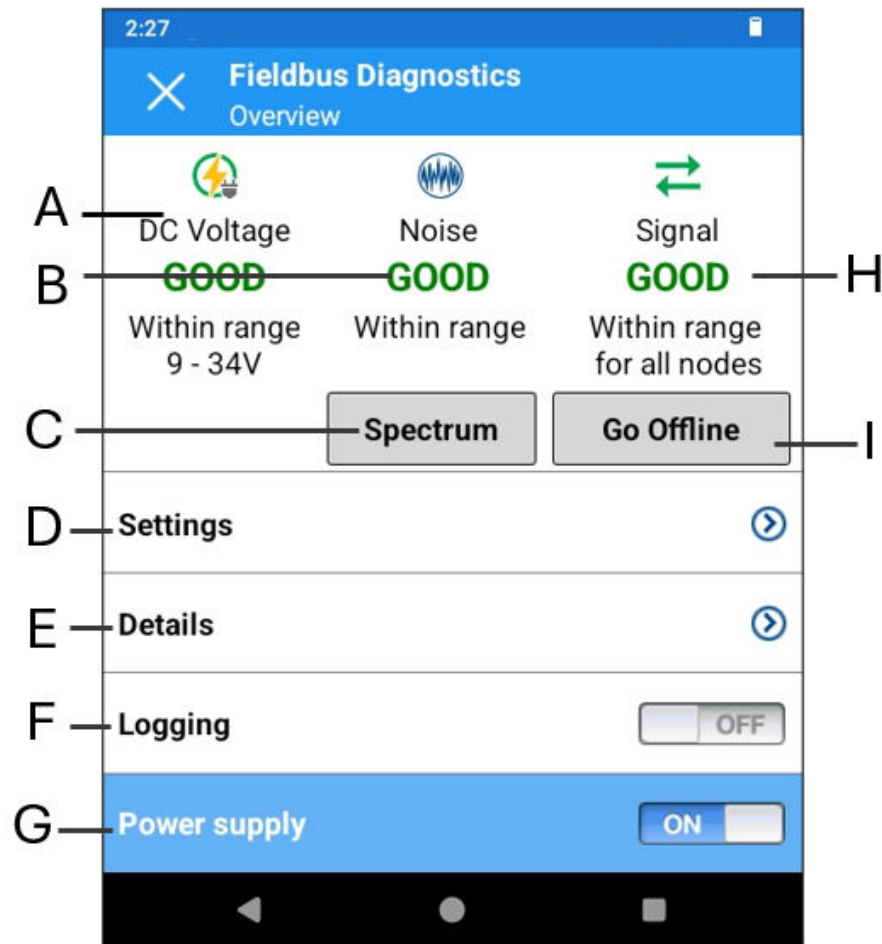


Figure 5-2: Fieldbus Diagnostics Overview screen while taking measurements



- A. View the status of the DC voltage measurement.
- B. View the status of the noise measurements.
- C. View a spectrum of the low-frequency, in-band, and high-frequency noise measurements.
- D. Set options for displaying and collecting the measurements.
- E. View the values for each measurement.
- F. Enable or disable saving the measurements to a log file (.csv), and set the logging settings. Multiple sets of measurements can be saved to create a trend/report.
- G. Enable or disable power to a FOUNDATION fieldbus device. The Trex unit needs the Device Communicator Plus communication module and the FOUNDATION fieldbus Power Plug to power a fieldbus device.
- H. View the status of the fieldbus signal measurement.
- I. Tap **Go Online** or **Go Offline** to have the Trex unit go online or offline. When the Trex unit is on an externally-powered fieldbus segment with fieldbus communications, **Go Online** queries devices for their tags. The option also adds the Trex unit to the device list on the Details screen, so you can compare the Trex unit's known good signal to a device's signal. When the Trex unit is powering a device or when there is no fieldbus



*communication on an externally- powered fieldbus segment, **Go Online** starts fieldbus network communications so fieldbus signals can be measured.*

#### Note

If you connect the Trex unit to an active fieldbus segment with a LAS, the devices, the device addresses, and signal measurements are displayed on the Details screen. However, the device's tag is displayed only after you tap **Go Online**.

#### Note

The Fieldbus Diagnostics application does not show which device is the LAS on the fieldbus segment. The Trex unit will become the LAS if no other LAS is on the fieldbus segment.

### ⚠ CAUTION

The Trex unit draws approximately 12 mA from the fieldbus segment when it is online. (The Trex unit draws 0 mA when it is offline.) Ensure the power supply or barrier on the fieldbus segment has the capacity to provide this additional current when the Trex unit is online. If a heavily loaded fieldbus segment is drawing near the capacity of the segment's power supply, connecting the Trex unit may result in loss of communication.

## 5.3 GOOD, BAD, and CHECK measurements in Fieldbus Diagnostics

The Fieldbus Diagnostics application uses labels of GOOD, BAD, and CHECK to indicate the status of a measurement. The label is applied based on the measurement being within a set of ranges that you can adjust. By default, the range of values includes typical operating levels of DC voltage, noise, and signal-level based on the Fieldbus standard.

You can set the range of measurement values that are labeled **GOOD**, **BAD**, or **CHECK** in the Settings. (Tap **Settings** → **Measurement criteria**.) You may want to increase or decrease the range of values based on where the Trex unit is connected on the fieldbus segment.

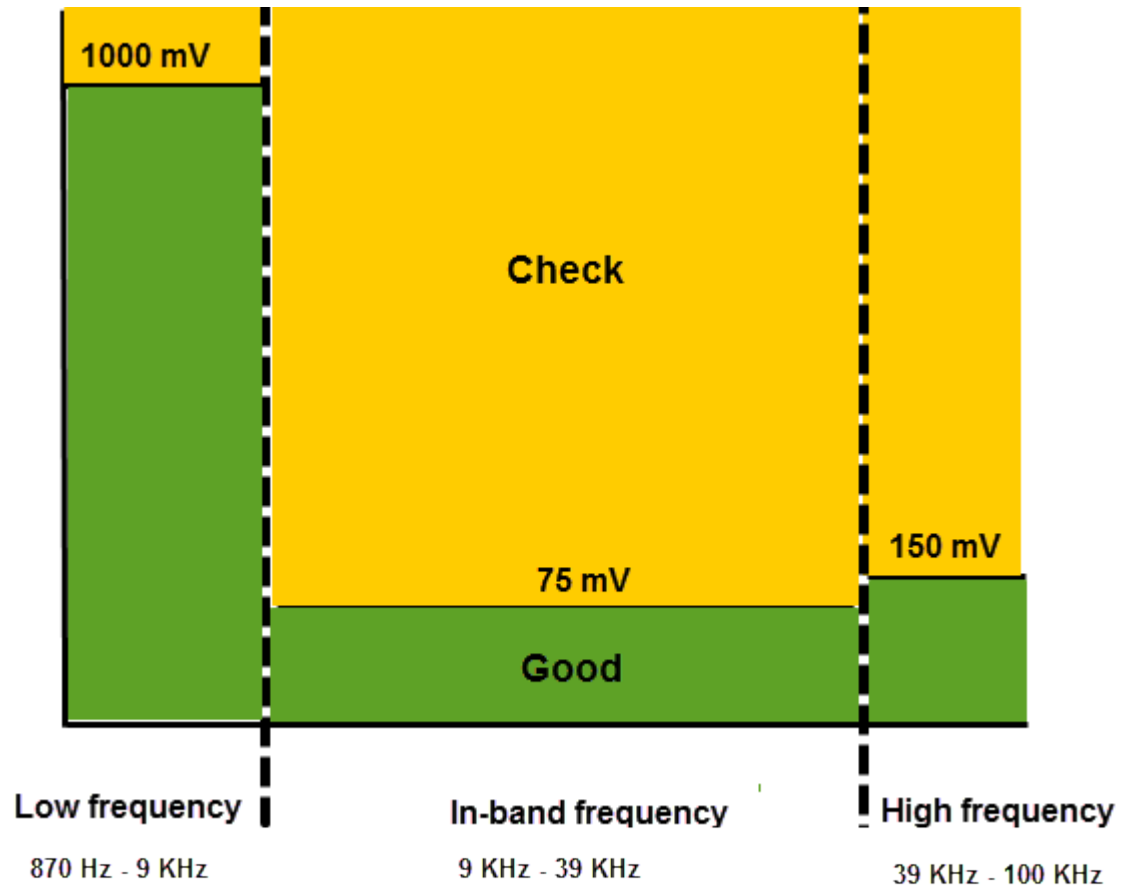
Status	Description
GOOD	The measurement is within the minimum and maximum values set in the measurement criteria.
BAD	The measurement is below the minimum value set in the measurement criteria. The BAD status is used for the DC voltage and signal measurements.

Status	Description
CHECK	<p>The measurement is greater than the maximum value or less than the minimum value defined the measurement criteria.</p> <p>The CHECK status is used for the noise and signal measurements because the measurements may be GOOD or BAD depending on the location of where the measurement is taken and on the fieldbus segment's tolerance to noise.</p> <p>For example, if the device's signal measurement is 400 mV (peak-to-peak) and the Trex unit was connected near the device, the measurement is low and may be considered BAD. However, if the Trex unit was connected to the fieldbus segment far away from the device, the lower signal measurement is expected due to the length of the cable and it can be considered GOOD.</p>
INACTIVE	<p>The Trex unit is detecting no fieldbus communication. Tap <b>Go Online</b> to communicate with the device.</p>

**Default status labels for the DC voltage measurement**



**Default status labels for the noise measurement**



**Default status labels for the signal measurement**



0-250 mV   250-700 mV   700-1000 mV   Greater than 1000 mV

If the fieldbus signal measurement has a BAD or CHECK status, an additional status note is listed on the Fieldbus Diagnostics Overview screen.

Fieldbus signal status note	Description
Within the range for all nodes	All devices on the fieldbus segment have a GOOD fieldbus signal.
Signal low/high on all devices	All devices on the fieldbus segment have signal measurements that are higher than the set maximum value or lower than the set minimum value.
Signal low/high on most devices	More than half of the devices on the fieldbus segment have signal measurements that are higher than the set maximum value or lower than the set minimum value.

Fieldbus signal status note	Description
Signal low/high on few devices	Fewer than half of the devices on the fieldbus segment have signal measurements that are higher than the set maximum value or lower than the set minimum value.
Signal low/high on <device address>	Only one fieldbus device has a signal measurement that is higher than the set maximum value or lower than the set minimum value.

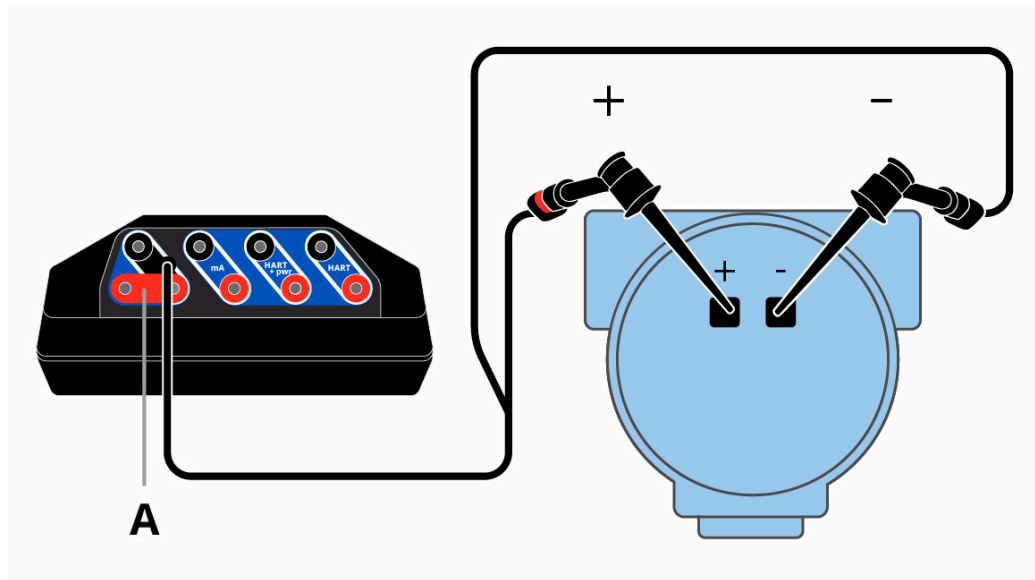
## 5.4 Wiring diagrams for the Fieldbus Diagnostics application

### ⚠ CAUTION

Remove the USB cable from the Trex unit before connecting to a device.

### ⚠ CAUTION

The Trex unit draws approximately 12 mA from the fieldbus segment when it is online. (The Trex unit draws 0 mA when it is offline.) Ensure the power supply or barrier on the fieldbus segment has the capacity to provide this additional current when the Trex unit is online. If a heavily loaded fieldbus segment is drawing near the capacity of the segment's power supply, connecting the Trex unit may result in loss of communication.

**Figure 5-3: Power and connect to a FOUNDATION fieldbus device**

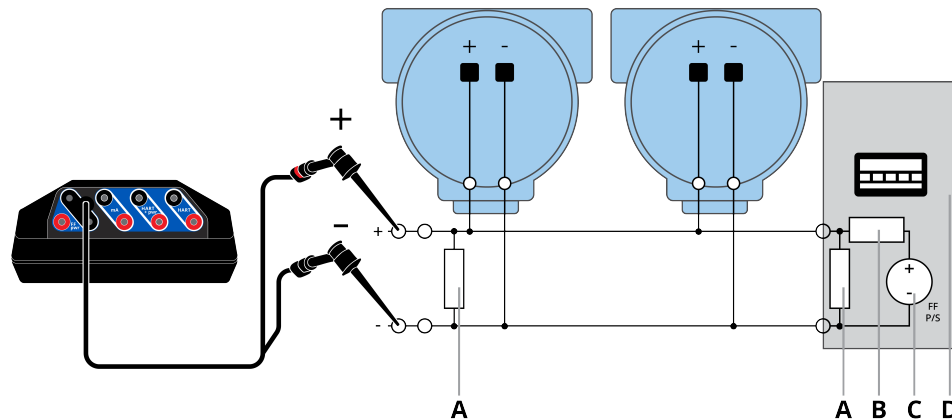
To power a FOUNDATION fieldbus device, the Trex unit needs the FOUNDATION fieldbus Power Plug. When the Trex unit powers a device, it also provides two terminators and a power conditioner.

**⚠ WARNING**

The Trex unit can power only one FOUNDATION fieldbus device in a bench setup.

A. FOUNDATION fieldbus Power Plug

**Figure 5-4: Connect to an externally-powered fieldbus segment**



For small fieldbus segments, the power conditioner and terminators can be contained in a single wiring block.

**Note**

You can connect the Trex unit at any convenient place along the fieldbus segment (bus). In the field, this is typically done at the device or at the fieldbus junction box. The drawing below is one example.

- A. Terminators
- B. Power conditioner
- C. Fieldbus power supply
- D. Host system

## 5.5 Power a FOUNDATION fieldbus device

The Trex unit can power one FOUNDATION fieldbus device. The Trex unit can provide approximately 10 volts at 25 mA to power a FOUNDATION fieldbus device. (The Trex unit will draw approximately 12 mA when it is online)

If you try to apply power from the Trex unit when the device is externally-powered, the Fieldbus Diagnostics application prevents the Trex unit from supplying power. This protects the Trex unit from damage.

**Note**

When the Trex unit powers a FOUNDATION fieldbus device, two internal terminators and a power conditioner are applied. Ensure the device is not connected to a fieldbus segment, even if the segment is unpowered.

**CAUTION**

Remove the USB cable from the Trex unit before connecting to a device.

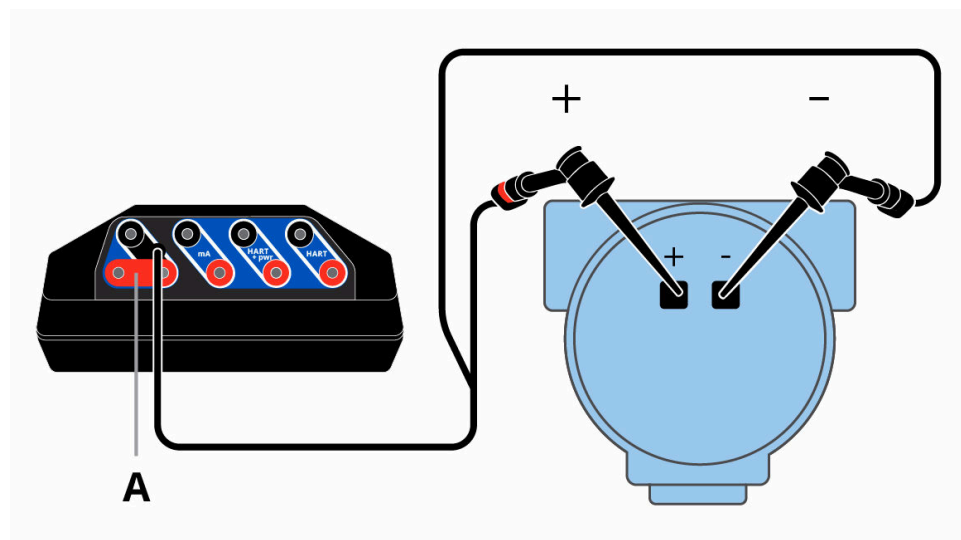
**⚠ WARNING**

Do not add any external power to the device when the Trex unit is powering the device. This can blow a fuse inside the Trex unit. The repair/replacement will need to be completed at an authorized service center. Ensure the device is disconnected from the loop/segment and no other wires are connected to the device before providing power from the Trex unit.

**Procedure**

1. Connect the lead set to the FF terminals on the Trex unit and directly to the communication terminals on the unpowered device. Ensure no other wires are connected to the device and there is no power to the device. Do not attach to a junction box.
2. Connect the FOUNDATION fieldbus Power Plug to the FF pwr terminal and the positive (red) terminal on the lead set.

**Figure 5-5: Connection for powering a FOUNDATION fieldbus device**



A. FOUNDATION fieldbus Power Plug

3. On the **Fieldbus Diagnostics Overview** screen, tap **Power Supply** to enable power to the device.  
The Trex unit powers the device.
4. To stop power, tap **Power Supply** or disconnect the lead set from the Trex unit.

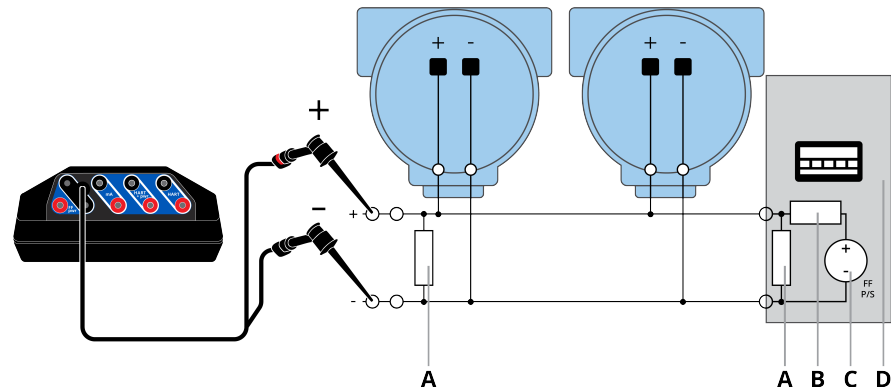
## 5.6 Connect to an externally-powered fieldbus segment

You can connect the Trex unit at various points, including at the device terminals or a point along the fieldbus segment. The example below is for connecting to the fieldbus segment to take measurements in the Fieldbus Diagnostics application.

### Procedure

1. Connect the lead set to the FF terminals on the Trex unit and to the fieldbus segment or device.

**Figure 5-6: One connection option for connecting to the fieldbus segment**



- A. Terminators
- B. Power conditioner
- C. Fieldbus power supply
- D. Host system

2. Open **Fieldbus Diagnostics**.  
The Trex unit connects to the device/fieldbus segment and begins the measurements.
3. Optional - Tap **Go Online** to query devices for their tags.

## 5.7 Measure the DC voltage, noise, and the fieldbus signal

The Fieldbus Diagnostics Overview screen displays a GOOD, BAD, or CHECK status for the measurements to give you a quick summary. Check the measurement criteria in the **Settings** to ensure they are appropriate for your installation.

You can view the actual measurement values by tapping Details on the Fieldbus Diagnostics Overview screen.

### Note

Before taking a noise measurement, remove the AC adapter from the Trex unit, if it is connected. This isolates the Trex unit from the local power grid.

### Procedure

1. If the FOUNDATION fieldbus device is externally-powered, do the following:
  - a) Connect the lead set to the FF terminals on the Trex unit and to the fieldbus segment or device.



- b) **Open Fieldbus Diagnostics.**  
The measurement status appears on the screen.
  - c) If the signal measurement status is "INACTIVE" or if you want to identify the device tags that are listed on the Details screen, tap **Go Online**.
2. If the FOUNDATION fieldbus device is not powered, do the following:
- a) Connect the lead set to the FF terminals on the Trex unit and directly to the communication terminals on the unpowered device. Ensure no other wires are connected to the device and there is no power to the device. Do not attach to a junction box.
  - b) Connect the FOUNDATION fieldbus Power Plug to the FF pwr terminal and the positive (red) FF terminal on the lead set.
  - c) **Open Fieldbus Diagnostics.**
  - d) On the Fieldbus Diagnostics Overview screen, tap **Power supply** to enable power to the device. The Trex unit powers the device.
  - e) If the signal measurement status is "INACTIVE" or if you want to identify the device tags that are listed on the **Details** screen, tap **Go Online**.

#### Related information

[View the live measurement values](#)

[Set the range of values for the GOOD and BAD status](#)

## 5.8 Details screen

By default, the Details screen displays information about the DC voltage, noise, and fieldbus signal measurements, including:

- The live measurement values, which are continuously updated.
- The units for each measurement.
- The minimum, maximum, and average measurement value.
- The number of devices on the fieldbus segment.
- The addresses of each device detected on the fieldbus segment. The device tag is also displayed if you selected **Go Online** on the **Fieldbus Diagnostics Overview** screen.

---

#### Note

By default, the **Details** screen is configured to show all the measurement data in columns, which do not fit on one screen. Scroll to the right on the screen to view additional columns. (To view only the measurements and the units, tap **Settings** → **Show Min, Max, Avg** to remove the checkmark.)

---

If a measurement is higher or lower than the set minimum or maximum values in the measurement criteria, the measurement is highlighted red or orange. Press and hold the measurement to display a Help option that lists some troubleshooting information. You can open Help for all cells on the **Details** screen.

## 5.9 View the live measurement values

The Fieldbus Diagnostics Overview screen displays measurements as a GOOD, BAD, or CHECK status. However, you can view the actual measurement values in real-time.

The Details screen also displays all the devices found on the fieldbus segment. If you selected **Go Online**, the devices are listed by tag and address. Otherwise, only the device address is listed.

### Procedure

1. Connect to the FOUNDATION fieldbus device or segment.
2. On the **Fieldbus Diagnostics Overview** screen, tap **Details**.  
The measurement values for the DC voltage, noise, and signal measurements are displayed.
3. Touch the screen and scroll to the right to view additional measurement values on the side of the screen.  
Measurements with a status of BAD are red. Measurements with a status of CHECK are orange.

### Related information

[Troubleshooting Fieldbus Diagnostics](#)

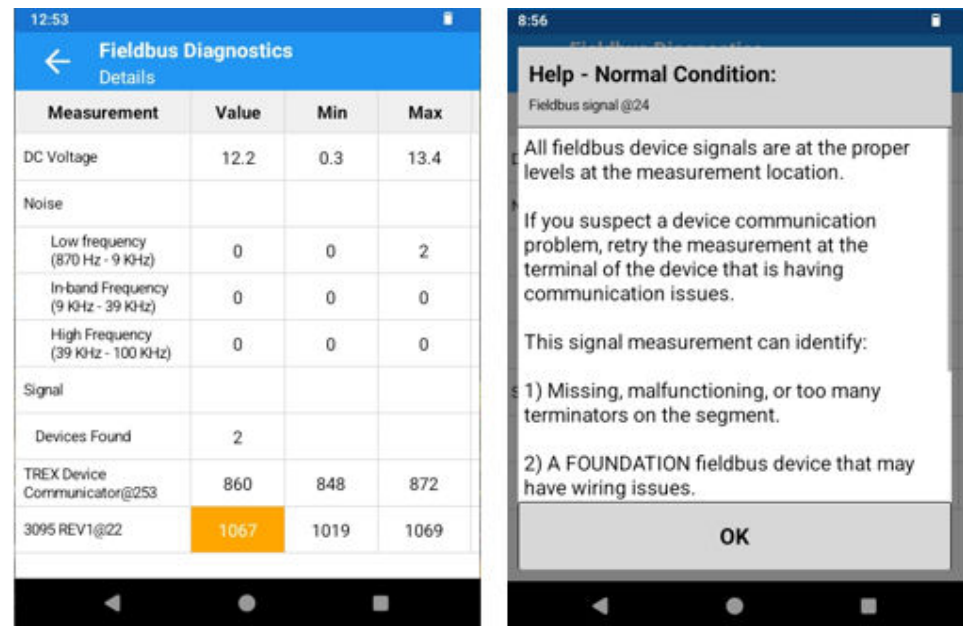
## 5.10 View help for a measurement

You can view help text that provides information about each measurement. Each cell on the Details screen has help text that describes overview information or actions you can take to help troubleshoot the measurement or problem, if a problem is detected.

### Procedure

1. Connect to the FOUNDATION fieldbus device or segment.
2. On the **Fieldbus Diagnostics Overview** screen, tap **Details**.
3. Press and hold on a measurement value, or highlight a cell and tap the checkmark button on the keypad.  
The Help text is displayed.

Figure 5-7: Help example



4. Tap **OK** to close the Help screen.

## 5.11 Noise spectrum

The noise spectrum gives you a real-time view of the different types of noise that were detected on the fieldbus segment. Various conditions can cause different types of noise. The spectrum displays the measurements grouped by low frequency, in-band, and high frequency noise. The frequencies between 9 and 39 KHz make the fieldbus signal.

### Note

Before taking a noise measurement, remove the AC adapter from the Trex unit, if it is connected. This isolates the Trex unit from the local power grid.

Frequency	Frequency range	Typical measurement values
Low frequency	870 Hz - 9 KHz	Less than 1000 mV (peak-to-peak)
In-band frequency	9 KHz - 39 KHz	Less than 75 mV (peak-to-peak)
High frequency	39 KHz - 100 KHz	Less than 150 mV (peak-to-peak)

The gray/shaded area at the top of the noise spectrum shows the values that would exceed the maximum values set in the measurement criteria for the low-frequency, in-band frequency, and high-frequency measurements. If the measurement is in the gray shaded area, the Fieldbus Diagnostics Overview screen shows a status of CHECK. If the measurement is below the gray/shaded area, the displayed status is GOOD.

The noise spectrum shows the highest measurement in mV (peak-to-peak) outlined in black. Tap **Reset Peak** to clear the black outline and have it reset to the most recent

highest peak. For example, use **Reset Peak** to clear a noise spike that was detected when connecting the Trex unit or other hardware to the fieldbus segment.

The measurements on the spectrum are also color-coded to indicate if the status of the measurement. The colors become darker as the measurement increases.

- Green = GOOD
- Yellow = CHECK
- Orange = CHECK

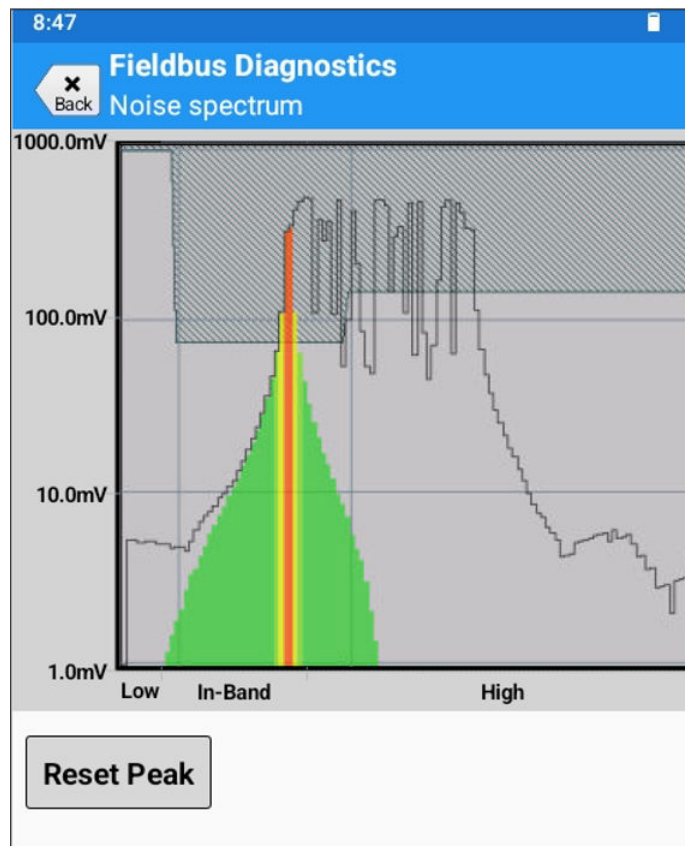
---

**Note**

The spectrum measurement will fail if the noise amplitude exceeds 1.5 V (peak-to-peak). If you see multiple high-amplitude noise peaks, look for an unattached wire that may cause high noise and saturate the noise detection.

---

**Figure 5-8: Highest amplitude marked with black outline**



---

**How noise affects the fieldbus segment**

The fieldbus segment can function properly with large amounts of low-frequency noise, small amounts of in-band noise, or moderate amounts of high-frequency noise. In-band noise is most likely to directly impact fieldbus communications. Bursts of in-band noise can cause the fieldbus network to slow down due to the messages being resent multiple times. Devices may also disconnect from the network if the in-band noise becomes too high/frequent.

High-frequency noise seldom impacts fieldbus communications, but it may cause measurement errors or the device may restart.

#### Related information

[Troubleshooting Fieldbus Diagnostics](#)

## 5.11.1 View a spectrum of the noise measurement

You can view the noise spectrum that displays the levels of low frequency (870 Hz - 9 KHz), in-band (9 KHz - 39 KHz), and high frequency noise (39 - KHz - 100 KHz).

---

#### Note

Before taking a noise measurement, remove the AC adapter from the Trex unit, if it is connected. This isolates the Trex unit from the local power grid.

---

#### Note

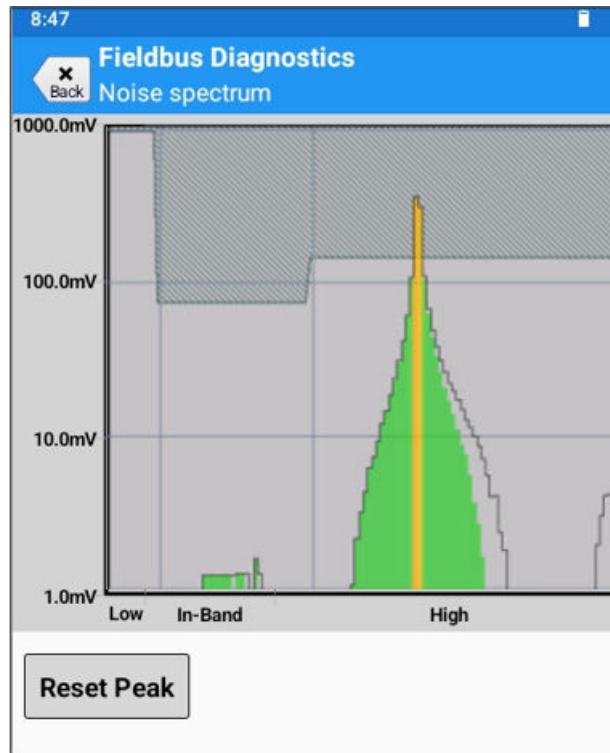
The spectrum measurement will fail if the noise amplitude exceeds 1.5 V (peak-to-peak). If you see multiple high-amplitude noise peaks, look for an unattached wire that may cause high noise and saturate the noise detection.

---

#### Procedure

1. Connect to the FOUNDATION fieldbus device or segment.
2. On the **Fieldbus Diagnostics Overview** screen, tap **Spectrum**.  
A spectrum displays the noise measurements. The highest peaks are outlined in black.

Figure 5-9: Example of noise spectrum



3. If necessary, tap **Reset Peak** to clear the peak on the spectrum.

## 5.12 Settings

Within the Fieldbus Diagnostics application, you can change the following settings:

- View or hide the minimum, maximum, and average values for each measurement.
- View or hide the host and device tags.
- Set the number of measurements to average.
- Set the minimum and maximum acceptable values for each type of measurement. This defines the range of values for the measurements labeled GOOD, BAD, and CHECK on the Fieldbus Diagnostics Overview screen.
- Reset all settings in the application to the default values.

### 5.12.1 View or hide the minimum, maximum, and average values for a measurement

The minimum, maximum, and average values are displayed on the **Details** screen. By default, these values are displayed.

**Procedure**

1. On the Fieldbus Diagnostics Overview screen, tap **Settings**.
2. Tap the **Show Min Max Avg** box to show or hide these values.

## 5.12.2 View or hide the device tags when online

When you tap Go Online on the Fieldbus Diagnostics Overview screen, the Trex unit is able to display the tag for the connected device and/or host system. However, you can hide these tags if you do not want the Trex unit to query a device for its identification.

**Procedure**

1. On the **Fieldbus Diagnostics Overview** screen, tap **Settings**.
2. Tap **Device Tags (when online)**.
3. Select one of the following options.

Option	Description
Fieldbus Host and Devices	Display the tags for the host on the fieldbus segment and the devices.
Fieldbus Devices Only	Display only the tags from the devices.
No Tags	Display no tags.

4. Tap **OK**.

## 5.12.3 Set the number of measurements to average

You can set the number of measurements to average for the DC voltage, noise, and signal level measurements. The option below applies to all three measurements; you cannot set a different number of averages for each measurement.

By default, the Fieldbus Diagnostics application averages the ten most recent measurements. The average value is displayed on the **Details** screen.

**Procedure**

1. On the Fieldbus Diagnostics Overview screen, tap **Settings**.
2. Tap **# of Measurements to Avg**.
3. Enter the number of measurements to average between 0 and 100.  
The default value is 10.
4. Tap **OK**.

## 5.12.4 Set the range of values for the GOOD and BAD status

You can set the range of measurement values that determine the GOOD and BAD status for a measurement on the **Fieldbus Diagnostics Overview** screen. Any measurements within the set minimum and maximum values are labeled GOOD. By default, the values are set to include typical operating levels of DC voltage, noise, and signal-level based on the Fieldbus standard.

If you adjust the minimum and maximum values, the values for the CHECK status adjust as well. If you expand range between the minimum and maximum values, the range of values for the CHECK status is reduced.

#### Procedure

1. On the **Fieldbus Diagnostics Overview** screen, tap **Settings**.
2. Tap **Measurement criteria**.
3. Enter the minimum and/or maximum values for each measurement type.
4. Tap **Back** to complete the changes.

### 5.12.5 Reset the Fieldbus Diagnostics settings to the default values

You can reset the settings back to the default values. You need to access two screens to set all settings back to their default values.

#### Procedure

1. On the **Fieldbus Diagnostics Overview** screen, tap **Settings**.
2. Tap **Reset to Default** to reset the options on the Settings screen to the default values.
3. Tap **Measurement criteria** on the Settings screen.
4. Tap **Reset to Default** to reset the options on the Measurement criteria screen to the default values.

## 5.13 Saving measurements to a log file

The Fieldbus Diagnostics application lets you save measurements to a log file, transfer the log file from the Trex unit to a PC, open the log file in a spreadsheet application, and chart the data to identify sporadic events or trends where the fieldbus segment is degrading.

You can log many measurements over 24 hours to catch a sporadic issue, or log measurements once a year to discover long-term changes in the performance of the fieldbus segment.

#### File type

The measurements are saved to a comma-separated values (.csv) log file on the Trex unit, so you can use several different spreadsheet programs, including Microsoft® Excel, on the PC to analyze and chart the data at a later time. You cannot view the contents of the log file from the Trex unit.

#### Creating trends/reports

When you enable logging, the Fieldbus Diagnostics application displays a screen of settings you can set for the log files. To create long-term trends/reports, set the **Save** option to **Append** and use the same log file for every measurement period. This allows the Fieldbus Diagnostics application to save multiple sets of measurements to one file, rather than overwriting the data each time you enable logging.



**Related information**[Enable or disable logging](#)[Save measurements to an existing log file](#)

## 5.13.1 Log file overview

The Fieldbus Diagnostics application can save measurements to a log file with the .csv (comma-separated values) file extension. The log file lists the information you entered when you enabled logging, including the fieldbus segment name, the name of the user taking the measurements, and the location of the measurements.

**Note**

As a best practice, create a new log file for each fieldbus segment and connection point you are monitoring, or ensure you update the segment name and measurement location fields each time you collect data.

**Automatically generated file names**

You can enter a file name for the log file or have the Fieldbus Diagnostics application generate one based on the device tag or the device ID of the host and devices found on the fieldbus segment. You must tap the **Go Online** option before enabling logging to automatically generate the file name.

**Note**

If multiple devices are on the fieldbus segment, the device or host system with the lowest address is chosen for the file name. (Typically, the fieldbus host system has the lowest address.) You can also enter a file name.

**Displayed data**

Each row represents a snap-shot in time when the measurement was taken and displays the values for the DC voltage, noise, and signal measurements. The DC voltage measurement value is displayed. The noise levels are divided by frequency into multiple columns, and the value in the row is the measurement value in mV (peak-to-peak). The signal measurements are organized by valid fieldbus address (16 -255), one column for each address. The value in each column is the measurement value in mV (peak-to-peak). Scroll to the right to see all columns in the log file.

**Figure 5-10: Example log file**

	A	B	C	D	E	F	G	H
1	Revision	1						
2	Segment Name	User Name	Location	Date	Time stamp	DcVoltage(V)	Number of Devices	Address 1
3	Segment 1	Tech1	AT_DEVICE	4/26/2016	12:53:20 PM	19.2		3 -
4	Segment 1	Tech1	AT_DEVICE	4/26/2016	12:53:30 PM	19.2		3 -
5	Segment 1	Tech1	AT_DEVICE	4/26/2016	12:53:40 PM	19.2		3
6	Segment 1	Tech1	AT_DEVICE	4/26/2016	12:53:50 PM	19.2		3
7	Segment 1	Tech1	AT_DEVICE	4/26/2016	12:54:00 PM	19.2		3
8	Segment 1	Tech1	AT_DEVICE	4/26/2016	12:54:10 PM	19.2		3
9	Segment 1	Tech1	AT_DEVICE	4/26/2016	12:54:20 PM	19.2		3
10	Segment 1	Tech1	AT_DEVICE	4/26/2016	12:54:30 PM	19.2		3
11	Segment 1	Tech1	AT_DEVICE	4/26/2016	12:54:40 PM	19.2		3
12	Segment 1	Tech1	AT_DEVICE	4/26/2016	12:54:50 PM	19.2		3
13	Segment 1	Tech1	AT_DEVICE	4/26/2016	12:55:00 PM	19.2		3
14	Segment 1	Tech1	AT_DEVICE	4/26/2016	12:55:10 PM	19.2		3
15	Segment 1	Tech1	AT_DEVICE	4/26/2016	12:55:20 PM	19.2		3
16	Segment 1	Tech1	AT_DEVICE	4/26/2016	12:55:30 PM	19.2		3
17	Segment 1	Tech1	AT_DEVICE	4/26/2016	12:55:40 PM	19.2		3
18								
19								

**Measurement intervals**

The Target Update Rate you set when you enable logging determines how many seconds occur between the sets of measurements, up to the maximum number of log entries you specify. The default is to take a DC voltage, noise, and signal measurement every 10 seconds up to 1,000 times. After 1,000 sets of measurements, the Fieldbus Diagnostics application turns off logging and stops saving measurements.

The measurements may be taken more frequently than the number you set for the Target Update Rate. If the Fieldbus Diagnostics application detects a device was added/removed or it detects a bad DC voltage, the application captures an extra measurement "row" in the log file to show the drop in voltage. The application attempts to take more data to help you troubleshoot and determine the cause of the readings.

**Note**

The actual update rate may be affected by conditions on the fieldbus network. For example, if the fieldbus network has a lot of scheduled activity, the rotation of the network token will be slow, and the Trex unit will wait longer to measure each device's signal.

**Viewing the saved measurements on a PC**

To view the saved measurements, you need to use Upgrade Studio to transfer the log file from the Trex unit to a PC. You cannot view the log files on the Trex unit.

**5.13.2 Enable or disable logging**

Use the logging option to save measurements to a comma-separated values (.csv) log file. You can save one set of measurements or append additional sets of measurements that you collect at a later date. Appending the measurements lets you create a trend/report of the fieldbus segment.

The log file will continue to save measurements until:

- You disable the logging option.
- The application has saved the selected number of measurements.
- The application has saved 100,000 entries in a log file. This is the maximum number.

- The file size is larger than 176 MB.

**Note**

As a best practice, create a new log file for each fieldbus segment and connection point you are monitoring. Otherwise, ensure you update the segment name and measurement location fields each time you collect data.

**Procedure**

1. Connect to the FOUNDATION fieldbus device or segment.
2. On the **Fieldbus Diagnostics Overview** screen, tap **Logging**.
3. Modify the following options, as needed.

Option	Description
User Name	The name of the person completing the measurements.
Segment Name	The name of the fieldbus segment. If you tap the <b>Go Online</b> option, the Fieldbus Diagnostics application creates a unique name. You can enter a new name.
File Name	The name of the .csv file that saves the measurements. You can enter a file name or you can have the application create one based on the device tag or device ID if you tapped <b>Go Online</b> before enabling logging. If multiple devices are on the fieldbus segment, the device with the lowest address is chosen for the file name.
Measurement Location	The location on the fieldbus segment where the Trex unit is connected to take the measurement. The options are <b>At Device</b> , <b>At Fieldbus Control Module</b> , and <b>At Hub</b> .
Save Option	Select <b>Append</b> to save the measurements to an existing log file of the same filename, or select <b>Replace</b> to overwrite the data in an existing log file with the same filename. Append is the default option. The log file is limited to 176 MB. If the file exceeds 176 MB, the application can no longer append additional log files/measurements to the existing file.

Option	Description
<p><b>Target Update Rate</b></p>	<p>The number of seconds in between each set of measurements. The default setting is to take a set of measurements every 10 seconds.</p> <p>If the Fieldbus Diagnostics application detects a device was added/removed from the device list or it detects a bad DC voltage, the application captures an extra DC voltage measurement in the log file to show the DC voltage dropping.</p> <hr/> <p><b>Note</b> The actual update rate may be affected by conditions on the fieldbus network. For example, if the fieldbus network has a lot of scheduled activity, the rotation of the network token will be slow, and the Trex unit will to wait longer to measure each device's signal.</p>
<p><b>Max Log Entries</b></p>	<p>The maximum number of measurement sets collected in one session and saved to the log file. A DC voltage, a noise, and signal measurement are one measurement set. These entries appear as a row in the .csv log file.</p> <hr/> <p><b>Note</b> If the maximum number of entries is reached, the Fieldbus Diagnostics application stops saving data to the log file. You can continue to append log entries to an existing log file, until the log file reaches the maximum file size.</p>

The Fieldbus Diagnostics application begins saving the measurements.

### 5.13.3 Save measurements to an existing log file

You can save measurements to an existing file on the Trex unit to create a trend/report of the fieldbus segment.

**Note**

The Fieldbus Diagnostics application does not let you browse to an existing log file saved on the Trex unit. You need to enter the file name.

**Procedure**

1. On the Fieldbus Diagnostics Overview screen, tap **Logging**.  
The Log Settings screen lists the current file name that is being used.
2. Check the name listed in the File Name field. If it is the desired file, tap **OK**.
3. If the desired file name is not listed, do the following:
  - a) Tap **File Name** on the **Log Settings** screen.
  - b) Tap **File Name**.
  - c) Enter the desired file name, and tap **OK**.
  - d) Tap **OK**.

4. Ensure **Append** is selected for the **Save Option**.
5. Tap **OK**.

### 5.13.4 Transfer a Fieldbus Diagnostics log file

Upgrade Studio saves files to a default location on your PC. After the files are transferred to the PC, the files are removed from the Trex unit.

#### Procedure

1. Close the Fieldbus Diagnostics application on the Trex unit.
2. Connect the Trex unit to the PC where Upgrade Studio is installed using a USB cable.
3. Open Upgrade Studio.  
The application connects to the Trex unit. The connected Trex unit is listed by its default name.
4. Next to **Fieldbus Diagnostics Dataset**, click **Transfer**.  
Upgrade Studio creates the folder, if necessary, to save the files and then transfers the files from the Trex unit to the PC. The Fieldbus Diagnostics file is removed from the Trex unit.
5. Click **OK**.
6. Click the file directory next to **Destination** to open the folder and access the transferred files.
7. To disconnect the Trex unit, remove the USB cable.

## 5.14 Troubleshooting Fieldbus Diagnostics

If you see a measurement labeled **BAD** or **CHECK**, tap **Details** to view the values for each measurement. Press and hold a measurement value on the screen to view Help that describes overview or troubleshooting information. You can also access the Help by holding the checkmark button on the keypad when a measurement value is selected.

#### Note

To prevent inaccurate **BAD** or **CHECK** readings, review the measurement criteria in the **Settings**, and set the minimum and maximum values to ensure they are appropriate for your installation.

DC voltage measurement	Possible cause	Action
Lower than expected	The power supply's voltage setting may be set too low.	Verify the power supply's voltage setting is correct. If necessary, increase the power supply voltage.

DC voltage measurement	Possible cause	Action
	An unexpected voltage drop may be due to a damaged cable, corrosion in the terminals, low impedance to ground, water in the device terminals, or loose connections.	Measure the voltage at several points on the fieldbus segment to determine the location of the unexpected voltage drop. Start at the power supply and continue toward the original measurement point where the voltage was measured low.
Higher than expected	There may be more than one voltage source on the fieldbus segment.	Ensure there is only one voltage source.
	The power supply's voltage setting may be set too high.	Verify the power supply's voltage setting is correct. If necessary, decrease the power supply voltage.

Low-Frequency noise	Possible cause	Action
Higher than expected	When the AC adapter is attached to the Trex unit, it can appear as low-frequency noise.	Disconnect the AC adapter from the Trex unit to isolate it from the local power grid.
	The device or shield is not properly grounded.	Ensure the device is properly grounded. Ensure the shield is properly isolated from the terminal housing. The shield should be grounded at only one location on the entire fieldbus segment and it should be a high-quality ground. Repeat these checks for all devices on the fieldbus segment.
	The power supply is not supplying a good, stable voltage.	Ensure the power supply is properly installed. Isolate the power supply and check for noise.

In-band frequency noise	Possible cause	Action
Higher than expected	The device or shield is not properly grounded.	Ensure the device is properly grounded. Ensure the shield is properly isolated from the terminal housing. The shield should be grounded at only one location on the entire fieldbus segment and it should be a high-quality ground.

In-band frequency noise	Possible cause	Action
	A cable may be damaged.	Visually inspect the cables and test the resistance between the two wires and each wire against the ground.

High-frequency noise	Possible cause	Action
Higher than expected	There may be loose wire connections.	Check for loose connections. Vibration from nearby motors or wind gusts may cause loose connections to be displayed as high-frequency noise.
	Water or moisture may be in the device's terminal housing.	Check the device's terminal housing.
	A cable may be damaged.	Use the signal or DC voltage measurement to find the cable portion that may be damaged. Visually inspect the cables, and test the resistance between the two wires and each wire to the ground.
	Variable-frequency drives installed near the fieldbus segment may not have the recommended grounding and filtering.	Check the grounding and filtering that are used.

Fieldbus signal	Possible cause	Action
Lower than expected	The Trex unit is attached far away from the FOUNDATION fieldbus device that is transmitting the signal.	Connect the Trex unit directly to the communication terminals on the device. No other wires should be connected to the device. Ensure the device is disconnected from any other terminators or devices. Connect the Trex unit to a connection point that is closer to the device on the fieldbus segment.
	The cable between the Trex unit and the device is damaged.	Determine if the signal loss is acceptable. If it is not, replace the cable between the Trex unit and the device. Fieldbus signals can be received when they are 250 mVp-p or higher, so loss of signal amplitude is tolerable.

Fieldbus signal	Possible cause	Action
	There are too many terminators on the fieldbus segment.	Review the number of terminators. A fieldbus segment should have two terminators.  <b>Note</b> The Trex unit adds two terminators when it powers a FOUNDATION fieldbus device.
Higher than expected	The Trex unit is attached to a block with short-circuit protection. Non-standard terminators are used to achieve short-circuit protection. This slightly changes the fieldbus signal, and the signal amplitude is increased by 20 to 30 percent.	To see the normal fieldbus signal amplitudes, connect the Trex unit to the trunk of the connector block.
	The Trex unit is powering a FOUNDATION fieldbus device, but it is not attached directly to the device terminals.	Ensure the Trex unit is connected directly to a single FOUNDATION fieldbus device. No other wires should be connected to the device. Ensure there are no resistors in-series with the device's terminals.
	When the Trex unit powers a FOUNDATION fieldbus device, non-standard terminators are used to meet Intrinsic Safety requirements. This slightly changes the fieldbus signal, and the signal amplitude is increased by 20 to 30 percent. The signal amplitude for the Trex unit is not impacted.	None. This is normal when the Trex unit is providing power. The higher signal level is acceptable on these terminators.
	The fieldbus segment is missing a terminator.	Attach another fieldbus terminator to the fieldbus segment.



# A Troubleshooting

## A.1 Troubleshoot HART communication

Symptom	Possible cause	Solution
"No Voltage Detected" message is displayed.	The lead set is improperly connected to the device.	Attach the lead set to the device.
	The Trex unit is connected to a 4-wire device or a wireless device that is powered by its battery.	None. This is expected behavior.
There is intermittent communication.	Insufficient loop current and voltage at the device terminals.	Verify there is at least 4 mA and 12 VDC at the device terminals.
	Noise on the loop, or noise or signal distortion from the control system. For example, noise from the power supply powering the devices, or front end analog circuitry inside the control system may be distorting the HART signal.	An oscilloscope can help determine noise or signal distortion of HART signals.
	Poor wiring.	Check the wiring terminations and exposed signal wire for damage.
There is no communication with device.	Insufficient loop resistance at the HART frequencies.	Add an additional 250 ohm resistor in series in the loop. Place the leads across the resistor and verify communication occurs.
	Insufficient loop current and voltage at the device terminals.	Verify there is at least 4 mA and 12 VDC at the device terminals.
	The AC adapter is attached to the Trex unit.	Remove the AC adapter from the Trex unit and try to connect to the device.
	Device may be set to a HART address other than zero (multidrop mode).	Change the polling mode to <b>Poll by Address</b> .
Control system is communicating HART, but the Trex unit is not communicating properly.	An internal fuse may be blown.	Connect a meter capable of measuring M ohms to the HART or mA terminals. An OPEN reading may indicate a blown fuse.

Symptom	Possible cause	Solution
	HART communication is being prevented by the control system.	Stop HART communications on the control system and verify if communication between the devices and the Trex unit is restored.
	More than one Trex unit or other secondary master may be attached to the control loop.	Ensure there is only one primary master and one secondary master on the control loop.
A HART device appears at the multiple addresses.	The incorrect polling addresses may be used.	Change the addresses being polled.
	HART Universal Revision 5 (or earlier), 6, and 7 devices are on the same loop.	Put HART Universal Revision 5 or earlier devices on a separate loop from HART Universal Revision 6 or 7 devices.
When the Trex unit tries to power a device, a message stating voltage still detected at HART terminals appears.	This message can appear if the Trex unit connects to a device that was recently powered. Some devices may hold voltage for several minutes after the power is removed.	The Trex unit asks if you want to ignore the voltage warning and proceed with sourcing power. If you select Yes, Trex powers the device. You can also wait a few minutes before connecting to and powering the device.
The Trex unit needs to supply more current than the typical 4 mA to power a positioner. This can occur when the positioner needs more current to power the CPU at faster speed for diagnostics.	Use the device connection wizard in the Field Communicator application to increase mA.	<ol style="list-style-type: none"> <li>1. In the Field Communicator application, connect to the positioner.</li> <li>2. Change its polling address to a non-zero value.</li> <li>3. Disconnect the positioner, and restart the Field Communicator application.</li> <li>4. Tap HART.</li> <li>5. Tap Yes when prompted if you want to provide power from the Trex unit.</li> <li>6. Tap Positioner.</li> <li>7. Tap Yes when prompted to increase current.</li> <li>8. Select the current value.</li> </ol>

## A.1.1 HART loops

Verify the HART loop current and voltage on the device. Almost all devices need at least 4 mA and 12V DC to operate properly. If there are multiple devices on a multidrop loop, set

the Trex unit to Poll by Address and ensure the Auto-Connect option in the Field Communicator Settings is disabled.

Inspect the loop wiring to identify problems. The shield is normally grounded at one end only, which is usually the control system.

### Sample values

Loop Current Flow Minimum voltage for 250 ohms.

mA	Volts
4 mA	1 Volt
8 mA	2 Volts
12 mA	3 Volts
16 mA	4 Volts
20 mA	5 Volts

If the voltage across the process-indicating device is greater than the value listed for a given current flow, the device has at least 250 ohms of internal resistance. If the voltage is less than the value listed in the table for the given current flow, more resistance needs to be added to the loop.

If an oscilloscope is available, use it to look for noise on the loop. Use a scope with differential mode capability or a battery powered/isolated scope to avoid grounding one side of the loop. Noise with a frequency of 500 Hz to 10,000 Hz is of particular interest, as this represents frequencies near the HART frequencies of 1200 and 2200 Hz.

## A.2 Troubleshoot fieldbus communication

Symptom	Possible causes	Solution
No communication with the device.	The Trex unit is connected to a fieldbus segment with a host system and the device on the same segment is being commissioned using the host system.	The Trex unit is unable to communicate with this device until you go offline and then back online.
	An internal fuse may be blown.	Connect a meter capable of measuring M ohms to the FF terminals. An OPEN reading may indicate a blown fuse.
Unable to change the address of a device.	The Trex unit is unable to change the address of a device that is currently the LAS.	Establish communication by putting the Trex unit on the fieldbus segment first and then adding one or more devices. By putting the Trex unit on first, it remains the LAS and allows the address change.

Symptom	Possible causes	Solution
The Trex unit does not remain the LAS on a fieldbus segment.	A host takes over as the LAS.	When a host is established on a fieldbus segment, it will take over as the LAS. No action is required.

## B Technical specifications

This chapter lists the specifications for the hardware and the AC adapter.

### B.1 Physical specifications

Specification	Value
Weight	Approximately 1330 grams
Height x width	7.75" x 5.5" inches
Display	5.7 inch color VGA resistive touchscreen
	640 x 480 pixel
Buttons (front of the Trex unit)	X button - similar to a Back key
	4 arrow buttons to navigate menus
	Checkmark - similar to an Enter key
USB	Micro USB connector. USB 2.0

### B.2 Communication module specifications

#### Device Communication Module

Terminal	Overview
HART terminals	The terminals enable HART communication with the Trex unit. Connectors: Two banana jack plugs. Internal fuse rating: 50 mA
Fieldbus (FF) terminals	The terminals enable FOUNDATION fieldbus communication with the Trex unit. Connectors: Two banana jack plugs. Internal fuse rating: 50 mA

**Device Communication Plus Module**

Terminal	Overview
HART terminals	The terminals enable HART communication with the Trex unit. Connectors: Two banana jack plugs. Internal fuse rating: 50 mA. <b>Optional internal resistors</b> 250 Ohm or 500 Ohm resistor. <b>Current control</b> Range: 3-22.5 mA Accuracy: 0.01% of reading Resolution: 1µA Drive capability: 650 ohms at 22.5 mA
HART + pwr terminals (Includes HART power supply, resistors, current control, and ammeter)	The terminals enable HART communication with the Trex unit, and provide power to one HART device in a bench setup. Connectors: Two banana plugs. <b>Internal resistor</b> 167 Ohm resistor. <b>HART power supply</b> Output: 22.9 V +/-0.2 V at no load. 16.4 V +/-0.3V at 22.5 mA. <b>Internal ammeter</b> Accuracy: +/- ( 0.01 % of the reading + 2uA). Temperature Range: 23°C +/- 5°C Drift: 3% /deg C outside the range 23°C +/-5°C Internal fuse rating: 50 mA. Range: Up to 24 mA. Resolution: 1µA <b>Current control</b> Range: 3-22.5 mA Accuracy: 0.01% of reading Resolution: 1µA Drive capability: 650 ohms at 22.5 mA
mA terminals (external ammeter)	The terminals measure current on a 4-20 mA current loop. Connectors: Two banana jack plugs. Internal fuse rating: 250 mA. Fuse is self resettable. Range: Up to 22.5 mA. Resolution: 1µA. Shunt resistor: 2.43 Ohms.
FF terminals	The terminals enable FOUNDATION fieldbus communication with the Trex unit. Voltage measurement accuracy: +/- 3% of reading for measurements greater than 3 volts.

Terminal	Overview
FF+ pwr terminal (Includes power supply, power conditioning, and two terminators)	<p>The terminal provides power to one FOUNDATION fieldbus device in a bench setup.</p> <p>Connector: One banana jack plug.</p> <p>Voltage measurement accuracy: +/- 3% of reading.</p> <p><b>Fieldbus power supply</b></p> <p>Output:</p> <p>0 mA (No device or Trex fieldbus communication)</p> <p>11 mA (No device, only Trex fieldbus communication)</p> <p>38 mA (38 mA for the device, no Trex fieldbus communication)</p> <p>38 mA (27 mA for the device and Trex fieldbus communication)</p> <p>Power conditioner: Included.</p> <p>Terminator: Two included.</p>

### B.3 Processor, memory, operating system specifications

Specification	Value
Microprocessor	1.2 GHz quad-core Cortex-A53/NXP i.MX 8M Mini
Memory	64 GB NAND flash
RAM	4 GB LPDDR4 SDRAM
Operating system	Android 14

### B.4 Environmental specifications



Specification	Value
Temperature limits	-20°C to +55°C (-4°F to 131°F) 0% to 95% RH non condensing for 0°C to +55°C (32°F to 131°F) For IS approval: -20°C to +50°C (-4°F to 122°F)
Charge	0°C to +35°C (32°F to 95°F)
Storage with power module	-20°C to +50°C (-4°F to 122°F) (less than 1 month)
Storage without power module	-20°C to +60°C (-4 °F to 140°F)
Enclosure rating	IP54 - protection from dust and splashing of water. Tested to the IEC 60529 specification.

Specification	Value
Shock	The unit shall survive a 1-meter, all sides and corners drop test onto concrete.

## B.5 Intrinsically Safe electrical parameters

Table 1: Device Communication Module

	FOUNDATION™ fieldbus	FOUNDATION™ fieldbus	HART®
	(non-FISCO)	(FISCO)	HART + and -
	FF + and -	FF + and -	
Ui	30 Vdc	30 Vdc	30 Vdc
li	380 mA	215 mA (IIC) 380 mA (IIB)	200 mA
Pi	1.3 W	1.9 W (IIC) 5.3 W (IIB)	1.0 W
Ci	0	0	0
Li	0	0	0
Uo	1.89 Vdc	1.89 Vdc	1.89 Vdc
Io	1.91 μA	1.91 μA	19.1 μA
Po	3.61 μW	3.61 μW	36.1 μW
Co	14.3 μF	14.3 μF	14.3 μF
Lo	100 mH	100 mH	100 mH

Table 2: Device Communication Plus Module

	mA interface	FOUNDATION™ fieldbus		HART®		FOUNDATION™ fieldbus	
		(non-FISCO)				(FISCO)	
	mA	FF pwr and F-	FF + and -	HART + pwr	HART + and -	FF pwr and F -	FF + and -
Ui	30 Vdc	17.5 Vdc	30 Vdc	30 Vdc	30 Vdc	17.5 Vdc	30 Vdc
li	200 mA	380 mA	380 mA	200 mA	200 mA	380 mA	215 mA (IIC) 380 mA (IIB)
Pi	1.0 W	1.3 W	1.3 W	1.0 W	1.0 W	1.3 W	1.9 W (IIC) 5.3 W (IIB)
Ci	0	20.5 nF	0	0	0	20.5 nF	0
Li	0	0	0	0	0	0	0
Uo	0.09 Vdc	17.44 V	1.89 V	28.35 Vdc	1.89 Vdc	17.44 V	1.89 V
Io	14.63 mA	153 mA	1.91 μA	68.1 mA	19.1 μA	153 mA	1.91 μA
Po	1.28 mW	1.73 W	3.61 μW	0.78 W	36.1 μW	1.73 W	3.61 μW



	mA interface	FOUNDATION™ fieldbus (non-FISCO)		HART®		FOUNDATION™ fieldbus (FISCO)	
		mA	FF pwr and F-	FF + and -	HART + pwr	HART + and -	FF pwr and F -
	Co	-	See table 3	14.3 μF	See table 4	14.3 μF	See table 3
Lo	-	See table 3	100 mH	See table 4	100 mH	See table 3	100 mH

Table 3: Co and Lo values for FF pwr and F-

Table 3: Co and Lo values for FF pwr and F-			
Co [nf]	249.5	318.5	318.5
Lo [μH]	100	50	30

Table 4: Co and Lo values for HART + pwr

Table 4: Co and Lo values for HART + pwr				
Co [nf]	56	62	71	79
Lo [μH]	1000	750	500	100

## B.6 Power module specifications

Specification	Value
Charge time	4 to 5 hours
LEDs	6 LEDs. Five LEDs for indicating the progress of charging. One LED to indicate the AC adapter is charging the power module.
Operating time	More than 8 hours of typical use
Type	Lithium Ion (Li-Ion)
Voltage	7.2V DC
Current	7Ah
Capacity	50Wh
Temperature limits	
Use	-20°C to +55°C (-4°F to 131°F)
Charge	0°C to +35°C (32°F to 95°F)
Storage	-20°C to +50°C (-4°F to 122°F) (less than 1 month)



### Instructions for storage, disposal, and safe handling of the power module

Follow the guidelines below for proper storage and disposal of the power module:

- Only use the power module for its intended purpose.
- Store the power module away from moisture in a cool dry place.

- Charge the power module with only the provided AC adapter.
- Fully charge any secondary power module before use.
- After storing the power module for an extended period of time it may be necessary to charge and discharge the power module several times to obtain peak performance.
- Do not dismantle, open, or modify the power module.
- Do not store power module in direct sunlight. Do not store on or next to heat-sensitive materials.
- Do not subject power module to mechanical shock.
- Do not leave power module on prolonged charge when not in use.
- Products, components and batteries should be disposed by the user pursuant to local and national waste and recycling rules.

**Safety Information**

- Li-Ion Rechargeable Power Module for Trex Device Communicator
- Do not charge, use and leave the power module at the high temperature. Do not heat the power module or throw it into fire.
- Do not deform, short-circuit, modify and disassemble the power module.
- Do not allow the power module to be wetted with or immersed in water or sea-water.
- Do not subject the power module to a strong impact or throw it - May cause heat, explosion and fire.

**INFORMATIONS DE SÉCURITÉ**

- Module d'alimentation rechargeable Li-Ion pour Trex Device Communicator.
- Ne pas charger, utiliser ou laisser le module d'alimentation exposé à des températures élevées. Ne pas chauffer le module d'alimentation ni le jeter au feu.
- Ne pas déformer, court-circuiter, modifier et démonter le module d'alimentation.
- Ne laissez pas le module d'alimentation être mouillé ou immergé dans l'eau ou l'eau de mer.
- Ne soumettez pas le module d'alimentation à un impact violent et ne le jetez pas - Cela peut provoquer une surchauffe, une explosion et un incendie.

## B.7 AC adapter specifications

Electrical Specification	PART NUMBER
	TREX-0003-0003 (PA65PD-1504000)
AC input voltage range	100-240 VAC
Frequency	50-60Hz
Input current	1.5A max at full load condition
Inrush current	80 A Max at 264VAC input

Electrical Specification	PART NUMBER
	TREX-0003-0003 (PA65PD-1504000)
Leakage current	<350uA.
Input protection	1.3A 250VAC
No load power consumption	<0.21W (at 115VAC / 23VAC)
Output voltage	15 V
Output current	4.0 A
Ripple and noise	150mVp-p max
Hold up time	10mS/20mS worst at full load 115/230VAC input
No load operation	Yes.
Short circuit protection	Self recovery when short circuit removed.
Over current protection	hiccup mode when over current, auto recovery
Over voltage protection	output voltage clamped by internal protection IC
Operating temperature range	0°C to 40°C
Operating humidity	10% to 90% relative humidity
Operating altitude	Maximum of 2000 meters
Storage temperature range	-20°C to +80°C
Storage humidity	5-95% RH non-condensing
Cooling	Free air convection
Dimensions	109 x 54 x 33 mm
Weight	0.33 kg
Withstand voltage	I/P-O/P (FG): 3kVAC / 10 mA / 1 minute
EMI	FCC Part 15B, CE EN55032 B, C-Tick AS/NZ CISPR22, EN61000-3-2:2014, EN61000-3-3:2013, EN55035:2017
Safety	UL, cUL62368-1, CE/GS EN62368-1, RCM/SAA/62368-1 Class II plug top model
Approvals	cUL North America, TUV GS Europe, Japan PSE, IRAM Argentina, EAC, South Africa SANS IEC 60 950, China CCC, Korea KC, Taiwan BSMI, UKCA WEEE 2012/19/EU, RoHS (2011/65/EU)



# C Approvals and Certifications

## C.1 Product certifications

See the AMS Trex Device Communicator website for the latest certificates, declaration of conformity, and approval information.


### Approved manufacturing location

R. STAHL HMI Systems GmbH - Cologne, Germany

### Labels

Each Trex unit has a main unit label. An Intrinsically Safe (KL option) Trex unit has another label on the side. If the Trex unit does not have this label, it is considered non-IS approved.

### Certifications and approvals




European directive information - CE compliance	
<b>ATEX</b> <b>(2014/34/EU)</b>	This equipment complies with the ATEX Directive. Applicable standards are EN IEC 60079-0:2018, IEC 60079-11:2023 Ed 7 and EN 60079-11:2012.
	Certification No. CSANe 25ATEX1027
	 II 2 G (1GD) Ex ia [ia Ga] [ia Da IIIC] IIC T4 Gb (Ta = -20°C < Ta < +50°C)
	<b>CE</b> 0158
<b>Electro Magnetic Compatibility (EMC)</b> <b>2014/30/EU</b>	Tested to the CISPR 32 V2.0 :2015/AMD1:2019, ETSI 301489-17 V 3.2.4:2020, IEC 61000-6-1 V3.0:2016, IEC 61000-3-2 V5.0:2018/AMD1:2020/AMD2:2024, IEC 61000-3-3 V3.0:2013/AMD1:2017/AMD2:2021 specification.
<b>Low Voltage</b> <b>2014/35/EU</b>	Tested to the IEC 61010-1:2010, IEC 61010-1:2010/AMD1:2016, and IEC 61010-2-030:2017 specification.
<b>RED</b> <b>2014/53/EU</b>	This equipment is in conformity with the Radio Equipment Directive (RED) Directive, ETSI EN 300328 V2.2.2:2019, and EN 18031-1:2024 standards.
<b>Battery Regulation</b> <b>2023/1542/EU</b>	Product is compliant with EU regulation 2023/1542:2023-07 and EU 2025/1561:2025-07.
<b>RoHS</b> <b>2011/65/EU</b>	Product is compliant with the RoHS Directive, EN IEC 63000:2018 / Exemption 7(a), 7(c)-I.

International certifications	
<b>IECEx</b>	Certification No. CSAE 25.0013
	Ex ia [ia Ga] [ia Da IIIC] IIC T4 Gb (Ta = -20°C < Ta < +50°C)

North American certifications	
<b>Canadian Standards Association - cCSAus</b>	Certification No. 25CA80222871
	Class I, Division 1, Groups A, B, C, D, T4. Class 1, Zone 1 AEx ia [ia Ga] [ia Da IIIC] IIC T4 Gb
<b>CSA</b>	Certification No. 25CA80222871
	Ex ia [ia Ga] [ia Da IIIC] IIC T4 Gb

## C.2 Wireless/Spectrum approvals

Wireless Spectrum Approvals	
FCC and ISED	<p><b>Radio frequency radiation exposure Information:</b> This handheld transmitter has been tested and found to comply with the FCC SAR limits for general population/uncontrolled radiofrequency exposure. The maximum listed SAR level is 1.44 W/kg.</p> <p><b>Information sur l'exposition aux rayonnements des ondes radio:</b> Cet émetteur portatif a été testé et jugé conforme aux limites de DAS établies par la FCC pour l'exposition aux fréquences radio du grand public / non contrôlée. Le niveau maximal de DAS indiqué est de 1,44 W/kg..</p> <p><b>NOTE:</b> This equipment has been tested and found to comply with the limits for a Class A electronic device, pursuant to Part 15 of the FCC Rules. These limits are designed to provide reasonable protection against harmful interference in a commercial or industrial environment. This equipment generates, uses and can radiate radio frequency energy and, if not installed and used in accordance with the instructions, may cause harmful interference to radio communications. However, there is no guarantee that interference will not occur in a particular installation. If this equipment does cause harmful interference to radio or television reception, which can be determined by turning the equipment off and on, the user is encouraged to try to correct the interference by one or more of the following measures:</p> <ul style="list-style-type: none"> <li>• Reorient or relocate the receiving antenna.</li> <li>• Increase the separation between the equipment and receiver.</li> <li>• Connect the equipment into an outlet on a circuit different from that to which the receiver is connected.</li> <li>• Consult the dealer or an experienced radio/TV technician for help.</li> </ul> <p><b>NOTICE:</b> This device complies with Innovation, Science and Economic Development Canada license-exempt RSS standard(s). Operation is subject to the following two conditions: (1) this device may not cause harmful interference, and (2) this device must accept any interference received, including interference that may cause undesired operation.</p> <p><i>Le présent appareil est conforme aux Innovation, Sciences et Développement économique Canada applicables aux appareils radio exempts de licence. L'exploitation est autorisée aux deux conditions suivantes:</i> (1) l'appareil ne doit pas produire de brouillage, et (2) l'utilisateur de l'appareil doit accepter tout brouillage radioélectrique subi, même si le brouillage est susceptible d'en compromettre le fonctionnement.</p> <p><b>NOTICE:</b> Changes or modifications made to this equipment not expressly approved by R. Stahl HMI Systems may void the FCC authorization to operate this equipment.</p> <p><b>NOTICE :</b> This Class A digital apparatus complies with Canadian ICES-003. <i>Cet appareil numérique de la classe A est conforme à la norme NMB-003 du Canada.</i></p>
Ghana	NCA Approved FMH-7E9-234-DH
Indonesia	Certificate No: 115360/DJID/2025

Wireless Spectrum Approvals	
	
Malaysia	<p>EMERSON</p>  <p>MCMC CIDF24000148</p>
Oman	<p>Oman - TRA</p> <p>Dealer No: D202897</p> <p>Certificate No: TRA/TA-R/24167/2025</p> 
Singapore	<p>Complies with IMDA Standards</p> <p>Registration Number: ESER/25/6172</p>
Thailand	<p>เครื่องโทรคมนาคมและอุปกรณ์นี้มีความสอดคล้องตามมาตรฐานหรือข้อกำหนดทางเทคนิค ของ กสทช</p> <p>This telecommunication equipment complies with NBTC standards.</p> <p>Supplier Declaration of Conformity No: SD06475-25</p>



# Glossary

## Activation

Activation updates the Trex unit with any needed licenses and enables the full functionality of the Trex unit. Activation also associates the Trex unit and its attached Trex modules with a user account/company.

## Ammeter

The mA terminals on the Device Communicator Plus communication module that enable the Trex unit to measure current on a 4-20 mA current loop. The HART + pwr terminals can also measure current.

## Burst mode

A communication mode in a HART transmitter to send data at regular intervals.

## Commissioned device

A device that has been set up to communicate with a host system. This usually includes assigning a permanent address to the device.

Some operations on the Trex unit are disabled for commissioned devices because they could cause process disruption.

## Communication module

A term to refer to either the Device Communicator communication module or the Device Communicator Plus communication module.

## Data Link Time

A network-wide time that is periodically distributed by the LAS to synchronize all device clocks on the bus.

## Device

See HART device or FOUNDATION fieldbus device.

## Device Communicator communication module

A communication module you can attach to the Trex unit. This module has terminals that enable the Trex unit to communicate with HART and FOUNDATION fieldbus devices.

## Device Communicator Plus communication module

A communication module you can attach to the Trex unit. This module has terminals that enable the Trex unit to communicate with HART and FOUNDATION fieldbus devices, power a HART or FOUNDATION fieldbus device, and measure current on a 4-20 mA current loop.

## Device description (DD)

A set of instructions written in the HART or FOUNDATION fieldbus Device Description Language that defines the parameters, commands, and methods that a host application uses to communicate with a HART or FOUNDATION fieldbus device.

## Externally-powered device

A HART or FOUNDATION fieldbus device that is powered by a power supply or digital control system. The Trex unit is not powering the device, loop, or fieldbus segment.

## Externally-powered loop

A HART or 4-20 mA current loop that is powered by a power-supply or digital control system. The Trex unit is not powering the loop.

#### **FOUNDATION fieldbus**

FOUNDATION fieldbus technology uses device descriptions and function blocks to enable intelligent devices to execute control functions traditionally performed by a distributed control system.

#### **FOUNDATION fieldbus device**

A device that communicates information using the fieldbus protocol on a digital, serial, multidrop data bus.

#### **FOUNDATION fieldbus Power Plug**

A connector with two banana jacks that allows the Trex unit to power a FOUNDATION fieldbus device. Attach the lead set to the FF terminals, and then attach the FOUNDATION fieldbus Power Plug to the FF pwr terminal and to the positive (red) FF terminal on top of the lead set.

#### **HART device**

A device that communicates information using the HART protocol.

#### **HART loop**

A network that combines an analog signal and digital signal to communicate the process variable and additional device diagnostics in a master/slave configuration. The network must have HART or HART-compatible devices and the proper amount of impedance, which may vary based on the device and network configuration.

#### **HART protocol**

Highway Addressable Remote Transducer communication protocol. An industry-standard protocol for digitally enhanced 4-20 mA communication with devices.

#### **HART tag**

An 8-character field used to identify a device. A 32-character long tag is also possible with HART Universal Revision 6 or higher devices. This field is stored in the HART device and can be modified.

#### **Intrinsic Safety (IS)**

Circuits that are designed to limit the amount of energy consumed or provided to devices to levels below those that are required to ignite specific types of hazardous materials under fault and no fault conditions.

It is also a method of providing safe operation of electronic process-control instrumentation in hazardous areas, such as flammable environments. IS systems keep the available electrical energy in the system low enough that ignition of the hazardous atmosphere cannot occur.

#### **Intrinsic Safety barrier**

A physical entity that limits the current and voltage into a hazardous area to satisfy Intrinsic Safety requirements.

#### **Lead set**

A cable with two banana plugs to connect the Trex unit to a device.

#### **Link Active Scheduler (LAS)**

The bus arbiter for the fieldbus segment. The LAS recognizes and adds new devices to the link, removes non-responsive devices from the link, and distributes Data Link (DL) and Link Scheduling (LS) time on the link.

### Link Master

A Link Master device controls when a device accesses the fieldbus segment and executes the link schedule, which synchronizes communications with function block execution on the fieldbus. The H1 card or any device that supports Link Master functionality can function as a Link Master device. Only one Link Master device can be active at a time on the fieldbus segment. This device is called the LAS.

### Link Master Configuration

An option to set a device as a basic or link master device. Only devices that are capable of being a Link Active Scheduler have this option.

### Link Scheduling time

Link Scheduling time is a link-specific time represented as an offset from Data Link Time. It is used to indicate when the LAS on each link begins and repeats its schedule. System management uses it to synchronize function block execution with the data transfers scheduled by the LAS.

### Offline

The Trex unit is not connected to or communicating with a live device.

### Online

The Trex unit is communicating with a live device.

### Pairing

Associating an AMS Trex unit with an AMS Device Manager database using USB. Once paired, an AMS Trex unit can synchronize device data with AMS Device Manager. A Trex unit can be paired to one AMS Device Manager system.

### Polling

A method of sequentially searching a network to determine which devices are present.

### Positioner

A digital valve positioner.

### Process variable

A process parameter that is being measured or controlled (for example, level, flow, temperature, mass, or density).

### Segment (fieldbus only)

The section of a fieldbus that is terminated in its characteristic impedance. Segments are linked by repeaters to form a complete fieldbus.

### Shortcut bar

The shortcut bar displays settings and information about the Trex unit, including viewing version numbers for the Trex unit and setting the screen brightness.

### Shout/deaf mode

A communication mode where the amplitude of the signal is increased. The Trex unit determines when to enter this mode. The icon (with a solid or hollow heart) indicates when the Trex unit is in this mode.

### Slot time

A setting that can help the Trex unit find FOUNDATION fieldbus devices on a fieldbus segment. A higher slot time helps the Trex unit find older FOUNDATION fieldbus devices on the fieldbus segment.

### **Status bar**

A black bar that displays at the top of all screens. The status bar displays the time and the power module icon.

### **Suspend**

A power management option to save power on the Trex unit. Suspend is similar to the standby mode on a phone.

### **Synchronization**

Ability to update AMS Device Manager database with device information from a Trex unit that has been paired. Synchronization is automatic, and can occur using USB or Wi-Fi.

### **Upgrade Studio**

A PC application that lets you update the Trex unit at your site. You can activate the Trex unit, download updated applications and device descriptions, and purchase new applications.

# Index

## A

AC adapter  
     charge power module 24  
     connector 11  
     overview 22  
 ac adapter(specifications) 178  
 activate  
     applications 40  
     Trex unit 40  
     without internet connection 41  
 activation  
     overview 37  
     verify status 37  
 address  
     change 105  
 Advanced menu 90  
 ammeter  
     communication module 16  
     overview 18  
     specifications 173  
 AMS Trex Security 35  
 ANSI (American National Standards Institute) conventions 5  
 app drawer 37  
 application  
     activate 37  
     close 31, 37  
     get new or updated 39  
     purchase 37  
     simultaneous 37  
     supported (PC) 39  
     switch between multiple 37  
     update 37  
     view open 31  
     view version number 33  
 approvals 181  
 approved manufacturing location 181  
 ATEX 181  
 Auto mode  
     fieldbus block 100  
 auto-connect to HART device  
     enable or disable 36  
     overview 47  
 auto-detect a device  
     overview 46  
 averages  
     set in Fieldbus Diagnostics 159

## B

backlight

backlight (*continued*)  
     change 31  
 bar charts  
     horizontal 110  
     vertical 110  
 basic device  
     set fieldbus device 105  
 block instantiation 100  
 block mode  
     change 101  
     overview 100  
 blocks  
     access 100  
     schedule 99  
 Bluetooth 32  
 brightness  
     adjust 31  
 burst mode 80

## C

calibration standard 42  
 certification 10  
 certifications 181  
 charts  
     gauge 110  
     horizontal bar 110  
     overview 109  
     strip/sweep/scope 110  
     vertical bar 110  
 communication module  
     install 20  
     location 15  
     overview 16  
     remove 20  
 communication terminals  
     FF 91  
     HART 58  
     HART + pwr 58  
 configuration  
     copy 86  
     create 85  
     delete 86  
     edit 82, 85  
     marked variable 82, 85  
     rename 86  
     save from a device 83  
     send to HART device 83  
 Connect - Select screen  
     overview 47  
     return to 47  
 connected deployment

connected deployment (*continued*)  
activate Trex unit 40

connections  
USB 39

connectors  
FF 16, 91  
FF pwr 16  
HART 16, 58  
HART + pwr 16  
mA 16

CSA 181

current  
change button values 133  
change duration 134  
control 114, 130, 135  
increase 134, 169  
measure 128, 136  
settings 133, 134

## D

damping 82

date  
format 33  
set 33

DC voltage  
measure on 4-20 mA current loop 136

DC voltage measurement  
Fieldbus Diagnostics 152  
fieldbus segment 152  
Loop Diagnostics 114  
save to log file 162  
set range of values 159  
view measurement status 152

Details screen  
view Help for a measurement 153  
view measurement values 153

device address  
change 105  
view for fieldbus device 102

device blocks 100

Device communication module  
remove 20

Device Communication Module  
install 20  
overview 16  
specifications 173

Device communication plus module  
remove 20

Device Communication plus module  
measure current 136  
power a HART device 127, 128, 130

Device Communication Plus Module  
install 20  
overview 16  
power a FOUNDATION fieldbus device 97, 150  
required for application 113

Device Communication Plus Module (*continued*)  
specifications 173

device configuration 84  
device connection wizard  
overview 49

Device Dashboard  
automatically open 47  
overview 52

device description  
forward compatibility rules 46  
get new or updated 39  
simulate 106  
view available on Trex unit 107  
view device revision 107  
view device type 107  
view manufacturer 107  
view revision 107

device ID  
use as log filename 162  
view for fieldbus device 102

device interoperability 46

Device List  
automatically open 46  
FOUNDATION fieldbus 96  
HART 71

device not found 96, 105

device parameter  
change 82, 103

device revision  
view for a connected device 102, 107

device screen  
bottom bar 54  
layout 54  
top bar 54

device tag  
change 104  
view for fieldbus device 102  
view/hide in Fieldbus Diagnostics 159

diagnostics  
fieldbus 141  
HART 113

disconnected deployment  
activate Trex unit 41

## E

email alerts  
receive for available updates 40

EMC 181

environmental specifications 175

## F

favorites  
add 87  
overview 86

- favorites (*continued*)
    - remove 88
    - view 87
  - FF pwr terminal 16
  - FF terminals 16
  - Field Communicator application
    - connect FOUNDATION fieldbus device 98
    - connect HART device 79
    - favorites 86
    - open or close 45
    - overview 45
    - power a FOUNDATION fieldbus device 97
    - power a HART device 76
    - power a Smart Wireless THUM adapter 78
    - settings 36
    - wiring diagrams 60, 66, 93
  - Fieldbus Diagnostics
    - create trend 160
    - DC voltage measurement 142
    - noise measurement 142
    - open or close 142
    - overview 141
    - Overview screen 142
    - power a FOUNDATION fieldbus device 142, 150
    - save measurements 160, 162, 164
    - settings 142
    - signal measurement 142
    - troubleshoot 165
  - Fieldbus Diagnostics log file
    - transfer to a PC 165
  - fieldbus methods
    - run 102
  - fieldbus polling 105
  - fieldbus terminals 91
  - forward compatibility rules 46
  - FOUNDATION fieldbus device
    - connect 98
    - power 97, 150
    - wiring diagrams 93
  - FOUNDATION fieldbus Power Plug 26, 91, 93, 148
- ## G
- gauge chart icon
    - on device menu 58
  - gauge charts 110
  - gestures 13
  - graphics 108
  - graphs 111
  - green LEDs 22
- ## H
- hand strap 26
  - hard shut down 28
  - HART + pwr terminals 16
  - HART device
    - connect 60, 79
    - power 76, 127, 128, 130
    - wiring diagrams 60
  - HART Device List
    - automatically open 46
    - overview 71
  - HART icons 80
  - HART loop
    - diagnostics 113
    - troubleshooting 170
    - wiring diagrams 60
  - HART polling options 49
  - HART terminals 16, 58
  - hazardous areas 9, 10
  - Help
    - view for a DD parameter 108
    - view for Fieldbus Diagnostics measurement 154
    - view for the Trex unit 29
  - high-frequency noise
    - measure 152
    - set range of values 159
    - view on spectrum 157
    - view values 154
  - Home screen
    - icons 29
    - return to 29
    - status bar 29, 30
  - hotkeys 86
- ## I
- icons
    - Home screen 29
    - on device menus 58
  - ID
    - create for Trex unit 32
  - IECEX 181
  - images 109
  - in-band frequency noise
    - measure 152
    - set range of values 159
    - view on spectrum 157
    - view values 154
  - instantiation 100
  - internal resistors
    - enable or disable 75
    - overview 72
    - values 72
  - intrinsically safe electrical parameters 176
  - IO block schedule 102
- ## K
- keypad 11, 12

**L**

- labels
  - serial numbers 15
- language
  - set 34
- LAS
  - overview 95
  - view in Field Communicator application 96
  - view on fieldbus segment 98
- lead set 26
- LEDs 22, 173
- lights
  - power module 22
- link active scheduler 95
- link master device
  - set fieldbus device 105
- log file
  - overview 161
  - save measurements to existing 164
  - transfer to a PC 42, 165
- loop check
  - measure current 136
  - overview 135
  - simulate a device 137, 138
- Loop Diagnostics
  - home screen 114
  - measured current 114
  - open or close 113
  - overview 113
  - safely close valve 113
  - sourced current 114
- loop resistance
  - increase 47, 75
  - resistors in Trex unit 72
- Low Voltage certification 181
- low-frequency noise
  - measure 152
  - set range of values 159
  - view on spectrum 157
  - view values 154

**M**

- mA terminals 16
- MAC address 32
- maintenance and repair 42
- Manual mode
  - fieldbus block 100
- mark parameter 82, 85
- measurement criteria 145
- memory
  - specifications 175
- menu
  - navigate using keypad 12
- Menu screen 55
- methods

- methods (*continued*)
  - run 102
- mode
  - Auto 100
  - change 101
  - Manual 100
  - Out of Service 100
  - overview 100
- mode parameters 100
- multidrop HART loop 36, 88
- My Device Not Found 71, 96, 105

**N**

- name
  - create for Trex unit 32
  - view 32
- navigation bar 29
- no internet connection
  - activate Trex unit 41
- noise
  - affecting the fieldbus segment 155
- noise measurement
  - high frequency 157
  - in-band frequency 157
  - low frequency 157
  - overview 141
  - save to log file 162
  - set range of values 159
  - view measurement status 152
  - view values 154
- noise spectrum 155, 157

**O**

- offline deployment
  - activate Trex unit 41
- Online menu
  - automatically open 47
  - overview 52
- open-source licenses 32
- operating system
  - version number 32
- orange LED 22
- Out of Service mode
  - fieldbus block 100
- Overview screen
  - device menu 52
  - Fieldbus Diagnostics 141

**P**

- paired
  - icon 30
- parameter
  - change 81, 82, 103



- parameter (*continued*)
  - mark 82, 85
- pc applications
  - supported 39
- pencil icon
  - on device menu 58
- polling options
  - FOUNDATION fieldbus devices 96, 105
  - HART devices 47, 88, 89
- positioner
  - connect 79
  - power 76, 116, 130
  - wiring diagrams 60, 119
- power button 11, 28
- power management
  - overview 34
  - screen timeout 34
  - shutdown timeout 35
- power module
  - charge 24
  - icon 30
  - install 24
  - LEDs 22, 23
  - location 15
  - maintain 26
  - overview 21
  - precautions 21
  - remove 25
  - specifications 177
  - view remaining charge 23
- power on/off 28
- power supply/charger, *See* AC adapter
- precautions
  - ammeter 18
  - before operating Trex unit 9
  - Device Communication Module 16
  - Device Communication Plus Module 16
  - power module and AC adapter 21
  - touchscreen 13
- processor 175

**R**

- range values 82
- reboot 28
- resistors
  - enable or disable 75
  - overview 72
  - values 72
- restart 28
- right arrow icon
  - on device menu 58

**S**

- scope chart 110

- screen
  - calibrate 33
  - clean 15
  - overview 13
  - specifications 173
- security
  - password 36
- segment
  - connect to 93, 151
- serial numbers
  - overview 15
  - Trex unit 6
  - view 6, 15, 32
- settings
  - Field Communicator application 36
  - Fieldbus Diagnostics 158
  - Loop Diagnostics 133
  - Trex unit 30
- shout/deaf mode 80
- shutdown timeout
  - overview 34
- signal level measurement
  - overview 141
  - save to log file 162
  - set range of values 159
  - view measurement status 152
- simulate
  - device for loop check 116
  - FOUNDATION fieldbus device 106
  - HART device 106
- slot time 96
- specifications
  - IS electrical parameters 176
  - memory 175
  - physical 173
  - power module 177
  - processor 175
  - storage 175
  - usage 175
- stand
  - replace 42
- status bar
  - HART icons 80
  - overview 30
- status message 83
- storage
  - view available 34
- storage specifications 175
- strip chart 110
- stroke valve 132
- sweep chart 110

**T**

- tag
  - change 82, 104
- technical support

technical support (*continued*)  
    contact 5  
    information to provide 6  
temperature  
    specifications 175, 177  
text  
    enter 14  
THUM adapter  
    automatically detect 36  
    power 78  
    wiring diagrams 66  
time  
    daylight saving 33  
    format 33  
    set 33  
time zone 33  
touchscreen  
    calibrate 33  
    clean 15  
    gestures 13  
    overview 13  
    precautions 13  
    specifications 173  
transmitter  
    connect 79, 98  
    power 76, 97, 116, 127  
    power and measure analog output 128  
    wiring diagrams 60, 66  
trend chart icon  
    on device menu 58  
turn on/off 28

## U

units  
    change 81  
    change for device 82  
Upgrade Studio  
    create user account 40  
USB  
    connect Trex unit 39  
    driver 39  
    overview 38  
    port location 11  
user account  
    create 40  
user configuration 84

## V

valve  
    stroke 132  
ValveLink Mobile  
    transfer files to a PC 42  
version number  
    application 6, 33

version number (*continued*)  
    operating system 6, 32  
vertical bar charts 110  
view spectrum 157  
voltage  
    measure 4-20 mA current loop 136  
    measure fieldbus segment 141  
    measurement specification 173

## W

wallpaper 35  
weight 173  
wireless  
    icon 30  
wiring diagrams  
    FOUNDATION fieldbus 93, 148  
    HART 60, 119  
    host system 119

## Y

yellow highlight on menu 81





**EMERSON™**