

HIOKI

INSTRUCTION MANUAL

SM-8213

SM-8215

SM-8220

SUPER MEGOHMMETER

HIOKI E. E. CORPORATION

Find Quality Products Online at:

www.GlobalTestSupply.com

sales@GlobalTestSupply.com

The super megohmmeter is a unique resistance meter designed to measure high resistance in a wide range. The meter outputs a high test voltage – 1000 V maximum for the SM-8220/8215, and 100 V maximum for the SM-8213 – to apply across the sample circuit.

Operators are requested to read this operation manual thoroughly before trying to operate the instrument for safety and to prevent electrical shock and damage to the measured circuit.

Keep this manual where all staff can access it any time.

1. Safety Precautions

Operators of the SM-8200 Series super megohmmeter are requested to read this operation manual thoroughly before operation for safety and to obtain best performance.

Operators are also requested to strictly observe all the DANGER, WARNING, and CAUTION notices in this manual and on the instrument to prevent injury and damage.

1-1 Safety Warnings

This operation manual includes some DANGER!, WARNING!, and CAUTION! notice with a symbol. These must be observed for safety of the operator and other persons, as well as for protection of your super megohmmeter and samples from possible damage and destruction.



DANGER

A "DANGER" CALLS ATTENTION TO A CONDITION OR POSSIBLE SITUATION THAT CAN CAUSE DEATH OR INJURY TO THE OPERATOR OR NEAR PESONS.



WARNING



A "WARNING" CALLS ATTENTION TO A CONDITION OR POSSIBLE SITUATION THAT COULD CAUSE DEATH OR INJURY TO THE OPERATOR OR NEAR PESONS.



CAUTION

A "CAUTION" calls attention to a condition or possible situation that could cause injury to the operator or persons nearby and damage and destroy the super megohmmeter and samples.

1.2 Symbols on the Super Megohmmeter

Symbol	Meaning	Description
	WARNING	This symbol is shown at parts whose usage needs reference to the operation manual.
	DANGER – HIGH VOLTAGE HAZARD	This symbol is shown at the Rx “-/+” Measuring terminals which carry a high voltage to be applied across the circuit to be measured.
		This symbol is shown at the GND terminal on the rear of the unit. If the ground prong of the power cord plug cannot be grounded, this terminal must be connected to the ground.

Safety Warning Labels on the Super Megohmmeter

1) DANGER and WARNING Labels on the Housing and Front Panel

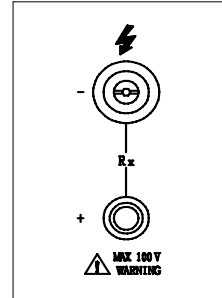
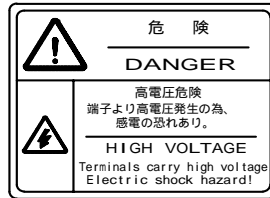
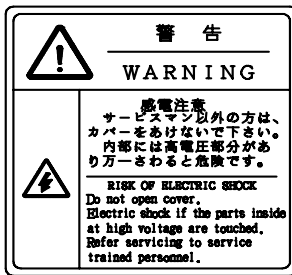

2) DANGER and WARNING Labels on the Rear Panel

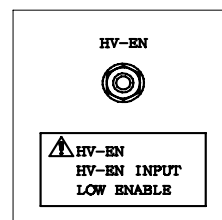
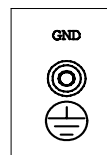
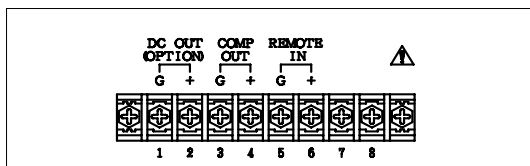
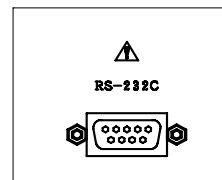
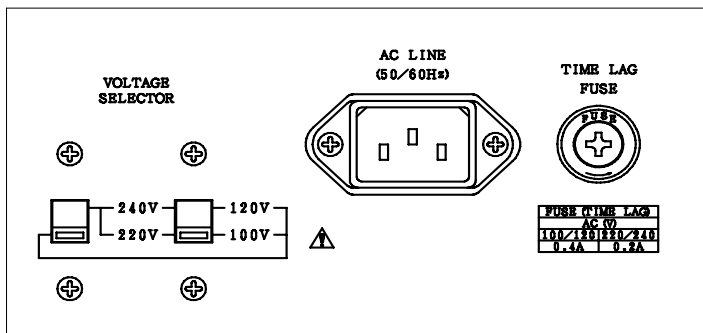

2. Operating Environmental Precautions



DANGER

Do not operate the super megohmmeters in the presence of flammable gas. There is a possibility of an explosion and/or fire.

Do not touch the Rx “-”/“+” measuring terminals on the front panel of the instrument during measurement. They output a maximum of 1000 V (SM-8220/8215) or 100 V (SM-8213) for measurement.



WARNING

Ground the ground prong of the power cord plug to avoid electrical shock. If the ground prong cannot be grounded, connect the GND terminal on the rear of the instrument to a ground. When the power cord plug is connected to the AC line socket via an accessory 3-prong to 2-prong adapter, the green ground tab of the adapter to the ground.

Do not remove the housing cover of the instrument. Even after turning off the instrument power switch, a dangerous residual voltage may be present for several minutes after the power is turned off. If repair or internal readjustment is needed, contact your dealer or Hioki representative.



CAUTION

Before turning on the power switch for the instrument, check that the VOLTAGE SELECTOR switches are set for your local AC line voltage. If the wrong AC line voltage is applied to the unit, it will be damaged (higher voltage supply) or will not function properly (lower voltage supply).

See 1.3 Setting VOLTAGE SELECTOR Switches for setting.

Use the right size and amperage power fuse. If a fuse of incorrect amperage is inserted into the fuse holder, the unit will be damaged.

See 1.4 Checking the Fuse Amperage for a correct fuse amperage.

Do not install or operate the super megohmmeter on a surface which is not level or not stable.

3. Installation Precaution



CAUTION

Do not install or place the super megohmmeter in a location which is not level, not stable or not sturdy enough to hold the instrument and other related items.

4. Instrument Handling Precautions



WARNING

If the instrument generates smoke or smell, unplug the power cord.

If such an instrument is kept powered on, it may cause a fire.

Contact your dealer or Hioki representative for repair.

Do not operate the instrument with a wet hand. This may cause electrical shock.



CAUTION

When moving or transporting the super megohmmeter, avoid shock and vibration as much as possible. For long-distance transportation, **put the instrument in a shock-absorbing carton or use the original shipping carton.**

When not using the super megohmmeter for an extended period of time, unplug the power cord from the AC line socket. Put a dust cover on the instrument. Store it in a place free of corrosive gas and **vibration, with a surrounding temperature within the range from -5 to 45 °C**, and humidity less than 85% RH.

Do not place anything on the instrument.

BRIEF DESCRIPTION

About the SM-8200 Series Super Megohmmeters

The SM-8200 Series super megohmmeters are insulation resistance meters consisting of a constant voltage power supply and a high sensitive current measuring section. The super megohmmeters are designed to measure the electrical resistance of insulating materials with high insulation properties.

The resistance measuring ranges of the SM-8200 Series are as follows:

SM-8213: 2.5×10^4 to 2×10^{12}

SM-8215: 2.5×10^5 to 2×10^{13}

SM-8220: 5.0×10^4 to 2×10^{16}

Each model of the super megohmmeters is provided with an LCD 320×240 dot display for easy observation of necessary information, including measuring voltage, measured resistance in both digital and analog, timer, and resultant GO/NO judgment.

The following shows the main specifications for the super megohmmeters.

For detailed specifications, see 2. SPECIFICATIONS.

For optional accessories, see 9. OPTIONAL ACCESSORIES.

Main Specifications – For detailed specifications, see 2. SPECIFICATIONS.

For optional accessories, see 9. OPTIONAL ACCESSORIES.

Measuring Voltage Ranges:

SM-8213 – 5, 10, 15, 25, 50 and 100 V

SM-8215 – 50, 100, 250, 500 and 1000 V

SM-8220 – 10, 25, 50, 100, 250, 500 and 1000 V

Measuring Resistance Range:

SM-8213: 2.5×10^4 to 2×10^{12}

SM-8215: 2.5×10^5 to 2×10^{13}

SM-8220: 5.0×10^4 to 2×10^{16}

Timer Function: Provided

Comparison and Judgment Function: Provided

HV-EN (High Voltage Enable) Interlocking Function: Provided

Voltage Charging Function: Provided

Voltage Discharging Function: Provided

RS-232C Interface Connector: Provided

Remote Measurement Function: Provided

DC Signal Output Function: Optional

1/R output or proportional to resistance value output

Organization of This Operation Manual

This operation manual contains the following 10 sections.

1. PREPARATION BEFORE OPERATION

This section describes precautions for unpacking and AC line voltage setting.

2. SPECIFICATIONS

This section describes the specifications for the SM-8200 Series super megohmmeters and optional accessories.

3. OPERATING PRINCIPLE

This section describes the operating principle with a block diagram of the SM-8200 Series.

4. FAMILIARIZATION WITH CONTROLS AND PARTS

This section describes the functions of the controls and parts on the front and rear panels.

5. PREPARATION FOR MEASUREMENT

This section describes the LCD display in detail for the measuring mode, setting mode and operations. A variety of measured value display methods are also given.

6. MEASUREMENT

This section provides details for function setting, connection to the work to be measured, and usage of a variety of optional measuring jigs and electrodes.

7. RS-232C INTERFACE

This section describes the application of the serial port interface.

8. REMOTELY CONTROLLED MEASUREMENT

This section describes the remote measuring function.

9. INTRODUCTION OF OPTIONALS

This section describes the optional accessories, including guard chips, DC signal outputs, and others.

10. MAINTENANCE AND MISCELANEOUS

This section describes maintenance and calibration.

11. EXTERNAL APPEARANCE

This section includes front, rear and side view illustrations of the instrument with dimensions.

CONTENTS

1. PREPARATION BEFORE OPERATION	1
1.1 Unpacking and Checking of the Contents	1
1.2 Operating AC Line Voltage	2
1.3 Setting the VOLTAGE SELECTOR Switches	2
1.4 Checking the Fuse Amperage.	3
1.5 Grounding the Chassis	4
1.6 Warm-up Period	5
2. SPECIFICATIONS	6
2.1 Measuring Performance	6
2.2 Function Specifications	7
2.3 Other Electrical and Physical Data	7
2.4 Optional Functions and Accessories	8
3. OPERATING PRINCIPLE	10
4. FAMILIARIZATION WITH CONTROLS AND PARTS	11
4.1 Front Panel	11
4.2 Rear Panel	13
4.3 Measuring Display	15
4.4 Measuring Condition Setting Display	16
4.5 Meanings of the Status and Mode Notices.	17
5. PREPARATION FOR A MEASUREMENT	18
5.1 Preparation.	18
5.2 Calibration	19
5.3 Basic Procedures for a Measurement.	20
6. MEASUREMENT.	21
6.1 Measuring Method.	21
6.2 Discharging Function	22
6.3 Charging Function	22
6.4 Interlocking Function - Using the HV-EN Connector	23
6.5 Comparison and Judgment Function	24
6.6 Setting a Variety of Functions	25
6.6.1 Setting the Timer	25
6.6.2 Setting the Comparison GO/NO Judgment Level	25

6.6.3 Setting Buzzer Sound ON/OFF	2 6
6.6.4 Setting the Charging Time, Measuring Time, Comparison GO/NO Judging Level and Buzzer Sound ON/OFF.	2 6
6.7 Changes in the Current Flowing through Insulators.	2 8
7. RS-232C INTERFACE	3 0
7.1 RS-232C Communication Commands	3 0
7.2 Applications of Commands	3 1
7.3 Connector Specifications.	3 1
7.4 Printer Output	3 2
8. REMOTELY CONTROLLED MEASUREMENT	3 3
9. INTRODUCTION OF OPTIONS	3 6
9.1 Guard Tip	3 6
9.2 DC Signal Outputs.	3 8
9.2.1 DC Output, RP-8000	
- Directly proportional or linear to resistance	3 8
9.2.2 DC Output, RI-8000	
- Inversely proportional or 1/R to resistance	4 0
10. MAINTENANCE AND MISCELANEOUS	4 1
10.1 Periodical Checking	4 1
10.2 Storage, Transportation and Abandon	4 1
11. EXTERNAL APPEARANCE	4 2

1. PREPARATION BEFORE OPERATION

1.1 Unpacking and Checking of the Contents

When you have received the carton of the SM-8200 Series super megohmmeter, carefully unpack it, and take out every thing from the carton.

Although the instrument and its accessories are severely inspected before shipment from factory, visually check the items and their quantities.

Keep the shipping carton for reuse at a later stage.

- 1) Visually check the external view of the instrument and its accessories.
- 2) Check the quantities of the list in accordance with the following list:

Table 1.1 List of Standard Accessories

Item	Reference No.	Q'ty	Remarks
Operation manual	OPA00007	1	This item means this booklet.
Power cord	OAC00001	1	Power cord with 3-prong plug with third for grounding
Power cord plug adapter	OAA00002	1	This adapter makes it possible to use the 3-prong plug power cord with 2-prong AC output. Attached to the power cord 3-prong plug when shipping from factory
Measuring rod (Red)	OGE00002	1	A measuring rod with a 1-meter cord to be connected to the Rx '-' socket.
Measuring rod (Black)	OGE00001	1	A measuring rod with a 1-meter cord to be connected to the Rx '+' socket.
Shorting plug	OGZ00003	1	A plug to be plugged to the HV-EN socket of the rear of the instrument. It is plugged to the HV-EN socket when shipping from factory.

Important!

When the accessory shorting plug is not plugged to the HV-EN socket on the rear of the instrument, the measuring high voltage is not output.

Note: The shorting plug is plugged to the HV-EN socket when shipping from factory.

 CAUTION When plugging the shorting plug, make sure that the power is turned off, otherwise, there is an electric shock hazard.
--

Upon checking the instrument and accessories, if any damage is found, immediately contact your dealer or Hioki representative.

1.2 Operating AC Line Voltage

The super megohmmeter can be operated from one of the following AC power source when the VOLTAGE SELECTOR switches are set accordingly.

<u>AC Line Voltage</u>	<u>Frequency</u>
100 V \pm 10%	50/60 Hz
120 V \pm 10%	50/60 Hz
220 V \pm 10%	50/60 Hz
240 V +10V, -10%	50/60 Hz



CAUTION

Before connecting the power cord to the AC outlet socket, confirm that the VOLTAGE SELECTOR switches on the rear panel are set to the positions, accordingly (See 1.3 Setting the VOLTAGE SELECTOR Switches.).

If the switches are set to wrong positions, a fire or burn may occur.

1.3 Setting VOLTAGE SELECTOR Switches

The super megohmmeter can be operated from one of the AC line voltages of 100 V, 120 V, 220 V and 240 V by setting the VOLTAGE SELECTOR switches to the specific positions, respectively.

Confirm the switch setting to the specific positions in accordance with Fig. 1.1.

If they are not set properly, correct their positions, accordingly.

To change the position of the switch, insert the tip of a flat blade screwdriver into the slot of the switch lever, and slide the lever upward or downward.



CAUTION

To change the VOLTASGE SELECTOR switch positions, be sure to Unplug the power cord plug from the AC line socket to prevent a possible damage.

When the switch position is changed while the voltage is on, the Switch contacts will be damaged.



CAUTION

The VOLTAGE SELECTOR switches have two positions - up and down. Slide the switch lever to either position until it stops.

Do not leave the lever at a neutral position. If the lever is set at a neutral position, a normal function cannot be obtained, and it will cause a failure.

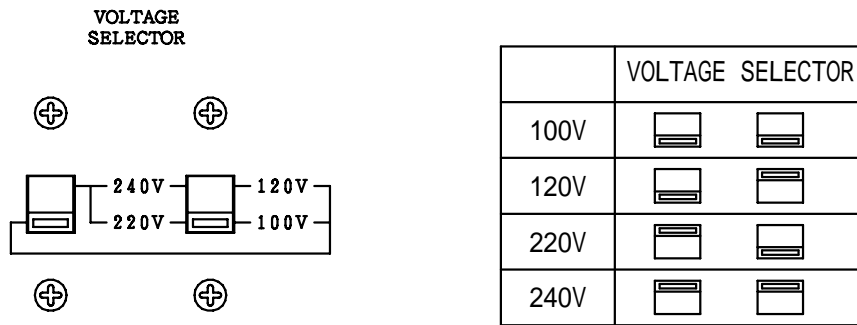

Fig. 1.1 VOLTAGE SELECTOR Switch Setting



CAUTION

When the VOLTAGE SELECTOR switch position is changed, fuse amperage must be changed to meet the requirements of the new AC line voltage.

Incorrect fuse amperage will cause a failure of the instrument.

1.4 Checking the Fuse Amperage

The fuse holder of the instrument contains a time lag fuse of the following amperage:

Time Lag Fuse	
<u>AC Line Voltage</u>	<u>Fuse Amperage</u>
100 V/120 V	0.4 A
220 V/240 V	0.2 A

Fuse Replacement

The fuse is inserted in the FUSE holder (Fig. 1.2) on the rear of the unit.

Remove the cap, and replace the fuse with a new one with a correct amperage.

To remove the cap of the fuse holder, use a 4 mm Phillips screwdriver, and turn the cap counterclockwise.

To set the cap in position, insert the cap, holding the fuse into the holder, and turn it with the screwdriver.

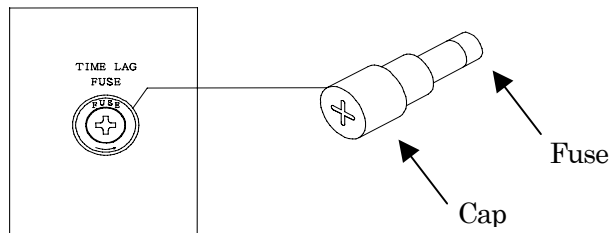

Fig. 1.2 Fuse Holder and Fuse Replacement



WARNING

To replace or check the fuse, make sure to disconnect the power cord from the AC line socket. If not, there is a fear of electrical shock.

1.5 Grounding the Chassis

To avoid an electrical shock accident, connect the GND terminal on the rear of the unit to the ground prong of the power cord to the ground post of the AC line system.

The round prong of the 3-prong plug of the power cord is the ground prong.

It is recommended to use an AC line socket with its third contact grounded for connection of the accessory 3-prong power cord.

To use the accessory 3-prong to 2-prong adapter to connect the power cord to a 2-contact AC line socket, make sure to ground the green tab of the adapter.



WARNING

To prevent an accident, connect the ground prong of the power cord Plug to the ground post of the AC line system. If it is impossible to ground the ground prong of the power cord plug, be sure to connect the GND terminal on the rear of the unit.

1.6 Warm-up Period

To obtain the performance of published specifications, allow the SM-8200 Series super megohmmeter to warm for a minimum of 30 minutes.

2. SPECIFICATIONS

2.1 Measuring Performance

1) Electrical Resistance Measurement

SM-8213

Measuring Range ()	Measuring Voltage
5.0×10^5 to 2×10^{12}	100 V
2.5×10^5 to 1×10^{12}	50 V
1.25×10^5 to 5×10^{11}	25 V
7.5×10^4 to 3×10^{11}	15 V
5.0×10^4 to 2×10^{11}	10 V
2.5×10^4 to 1×10^{11}	5 V

Accuracy of measuring voltage: $\pm 3\%$ of set value

Measuring output current: 50 mA maximum

Accuracy of measurement: $\pm 10\%$ (A range of 10 times of the minimum value of each range)

SM-8215

Measuring Range ()	Measuring Voltage
5.0×10^6 to 2×10^{13}	1000 V
2.5×10^6 to 1×10^{13}	500 V
1.25×10^6 to 5×10^{12}	250 V
5.0×10^5 to 2×10^{12}	100 V
2.5×10^5 to 1×10^{12}	50 V

Accuracy of measuring voltage: $\pm 3\%$ of set value

Measuring output current: 2 mA maximum

Accuracy of measurement: $\pm 10\%$ (A range of 10 times of the minimum value of each range)

SM-8220

Measuring Range ()	Measuring Voltage
5.0×10^6 to 2×10^{16}	1000 V
2.5×10^6 to 1×10^{16}	500 V
1.25×10^6 to 5×10^{15}	250 V
5.0×10^5 to 2×10^{15}	100 V
2.5×10^5 to 1×10^{15}	50 V
1.25×10^5 to 5×10^{14}	25 V
5.0×10^4 to 2×10^{14}	10 V

Accuracy of measuring voltage: $\pm 3\%$ of set value

Measuring output current: 2 mA maximum

Accuracy of measurement: $\pm 10\%$ (A range of 10 times of the minimum value of each range) except for $\times 10^8$ range.
 $\pm 20\%$ for $\times 10^8$ range

2) Measuring Time (Sampling Cycle)

Approx. 200 ms

2.2 Function Specifications

1) CHARGE Function

This function charges the sample to be measured by applying the Selected measuring voltage when the CHARGE switch is pushed.

Internal Resistance

SM-8213: Approx. 0

SM-8215: Approx. 30k

SM-8220: Approx. 30k

2) DISCHARGE Function

This function discharges a residual voltage on the sample after measurement when the DISCHARGE switch is pushed.

Internal Resistance

All models: Approx. 100k

3) HV-EN (High Voltage Enable) – Interlocking Function

This function externally controls to make the output of measuring voltage on or off.

This function is used in combination with an interlock switch on the measuring jig so as to prevent an electrical shock during measurement.

4) TIMER Function

This function determines the voltage charging time and the measuring time, respectively, within a range from 1 to 999 seconds. After the set time is up, the measured value is shown held.

5) COMPARISON and JUDGMENT Function

This function makes a comparison of the measured value with the preset judgment value, and if the measured value is less than the judgment level, it makes the alert buzzer sound, closing the incorporated relay contacts.

6) RS-232C Interface Function

This function allows a control of an optional printer via RS-232C interface.

The optional printer prints measured data.

7) REMOTE MEASUREMENT Function

This function allows a remotely controlled measurement by means of a remote switch.

2.3 Other Electrical and Physical Data

1) Environmental temperature and Humidity

Operation: 0 to 40 (SM-8213/8215), less than 85% RH

0 to 35 (SM-8220), less than 85% RH

Storage: -5 to, less than 85% RH

2) Power Requirements

AC 100 V, 120 V, 220 V, ± 10%, 240 V +10 V, -10% 50/60 Hz

3) Power Consumption

Approx. 25 VA

4) Dimensions

Approx. 284 (W) × 139 (H) × 215 (D) mm

Also, see 11. EXTERNAL VIEW for external appearance.

5) Weight

Approx. 4.3 kg

2.4 Optional Functions and Accessories

In addition to the standard accessories shown in 1.1 Unpacking and Checking of the Contents and Table 1.1 List of Standard Accessories, the following two groups of optional accessories are available to expand the applications of the SM-8200 Series super megohmmeters.

1) Options – designed exclusive for the SM-8200 Series

Name	Model	Remarks
DC signal output (resistance value proportional or linear signal)	RP-8000*	Factory installed
DC signal output (1/R signal)	RI-8000*	Factory installed
Guard chips	0GZ00001	See 9.1.
Printer	0KC00001	
Printer cable	0GC00004	
Printer roll chart	P000119	
Printer ribbon cassette	P000124	
RS-232C cable (DOS/V)	0GC00002	
HV-EN connection plug with cord	0GZ00002	
Time lag fuse, 0.4 A, 5 pcs./pack	0AE00001	100 V/120 V line
Time lag fuse, 0.2 A, 5 pcs./pack	0AE00002	220 V/240 V line

*Either one of the RP-8000 or RI-8000 optional function can be installed in a single SM-8200 Series unit.

2) Options – designed for common to SM-8200 Series, SM-8216, and SM-8000 Series super megohmmeters.

Name	Model	Description
Electrode for plate samples	SME-8310	With surface/volumetric selector, interlock function
Electrode for plate samples	SME-8311	
Weight electrode	SME-8320	With surface/volumetric Selector. Needs shield box.
Shield box	SME-8350	Electromagnetic shielding
Mercury electrodes	SME-8322	Stainless steel ring electrodes designed to put mercury between them.

-- continued --

Name	Model	Description
Electrode for surface resistance measurement	SME-8301	Simplified electrode for surface resistance measurement
Electrode for surface resistance measurement	SME-8302	Simplified electrode for curved surface resistance measurement
Electrodes for liquid sample measurement	SME-8330	Capacity, approx. 25 mL Electrode constant: Approx. 500 cm
Electrodes for continuous liquid sample measurement	SME-8335	Capacity, approx. 30 mL Electrode constant: Approx. 75 cm
Electrodes for chip capacitors	SME-8360	Chip capacitor measurement

Other types of optional electrodes and devices are available upon request.

Contact your dealer or Hioki representative.

3. OPEARATING PRINCIPLE

The SM-8200 Series super megohmmeters consist of a constant voltage power supply and a high sensitive current measuring section to be combined to compose a resistance measuring circuit. The current measuring section is composed of a current detective resistor, low drift voltage amplifier and an integrator-type A/D converter. A measured resistance value is computation-processed by a CPU to display the result on a liquid crystal display (LCD).

Fig. 3.1 shows a circuit composition of the SM-8200 Series.

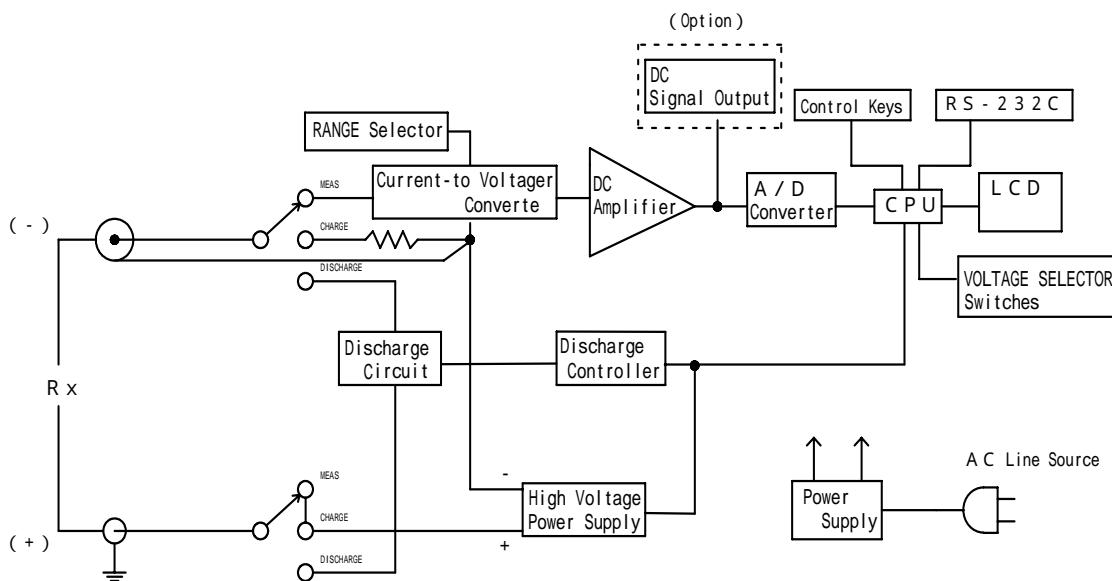

Fig. 3.1 Circuit Composition

4. FAMILIARIZATION WITH CONTROLS AND PARTS

4.1 Front Panel

The figure below shows the front panel of the SM-8200 Series. However, note that the values for the two knobs on the right are represented by those of the SM-8213.

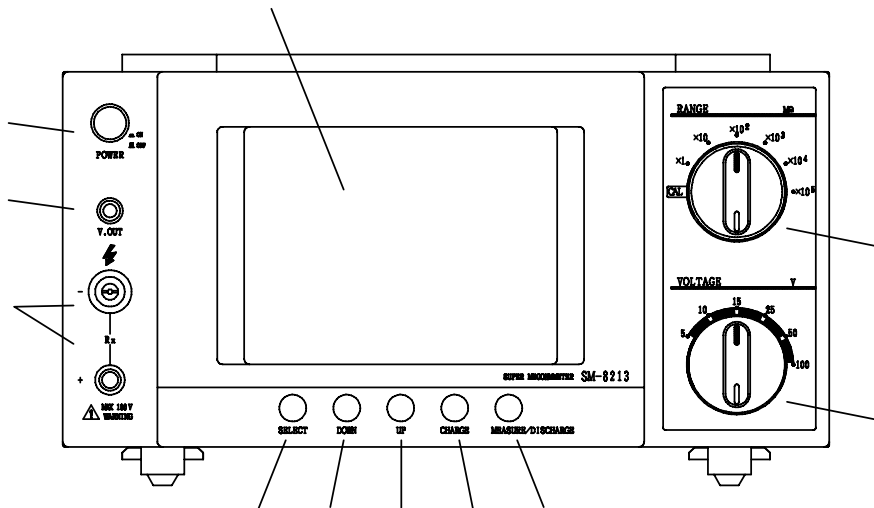

Fig. 4.1 Front Panel

LCD Display: This is a 320 × 240 dot liquid crystal display module.

This shows measured results, measuring conditions and a variety of data settings.

POWER Switch: This is a power switch to turn on or off the instruments.

A press of this switch in the released position turns ON the unit.

A press of this switch in the pushed position turns OFF the unit.

V. OUT Indicator: This indicator lights when the Rx -/+ measuring terminals carry a measuring voltage across them.

Rx -/+ Measuring Terminals: These terminals carry a selected measuring voltage across them to measure the insulation resistance of a sample via a pair of measuring rods or electrodes.

Note: Each of the terminals is incorporated with a plug insertion detector switch. Unless otherwise this switch is turned on by a full insertion of the plug of the measuring rod or electrode, the output voltage circuit cannot be completed – no output.

SELECT Switch: This switch moves the cursor in the LCD display to the desired item set it.

This switch also acts as a STOP switch; this switch makes the voltage

on the Rx -/+ measuring terminals OFF when it is pressed while the measuring voltage is being applied.

DOWN Switch: This switch decreases the value to set each time it is pressed.

UP Switch: This switch increases the value to set each time it is pressed.

CHARGE Switch: This switch applies the measuring voltage across the Rx measuring terminals to charge the sample to be measured when it is pressed. During the charging period, the V. OUT indicator lights. The next press of this switch discharges the sample, turning off the V. OUT indicator.

Note: When the timer function is used to determine the charging period, the measurement automatically starts when the set time is up.

MEASURE/DISCHARGE Switch: This switch starts a measurement of the sample in connection, when it is pressed, turning on the incorporated indicator and the V. OUT indicator.

The next press of this switch discharges the sample, turning off the two indicators.

VOLTAGE Selector Switch: This switch selects the voltage to be applied across the Rx +/- measuring terminals. The arrow on the knob shows a voltage to output.

RANGE Selector Switch: This switch selects a factor for the measured value.

The selected factor is also shown at the $\times 10$ multiplier area.

4.2 Rear Panel

The figure below shows the rear panel of the SM-8200 Series. However, note that the VOLTAGE SELECTOR switches are set for the operation from 100 V AC line.

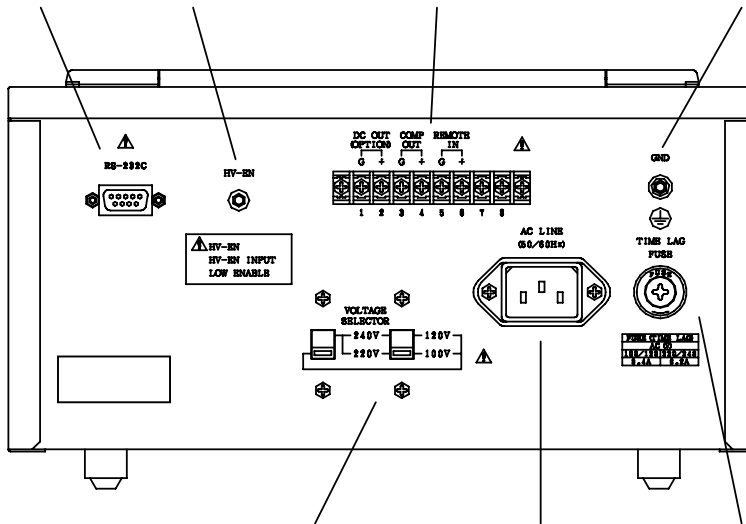

Fig. 4.2 Rear Panel

VOLTAGE SELECTOR Switches: These two switches are to be set in accordance with the local AC line voltage (50 or 60 Hz) for the instrument.

For a proper setting, see 1.3 Setting VOLTAGE SELECTOR Switches. For line voltage change between 100 V/120 V and 220 V/240 V, the power fuse amperage must be also changed accordingly.

AC LINE Receptacle: This connects the accessory power cord.

TIME LAG FUSE Holder: This holder contains a time lag fuse in a glass tube. The amperage of the fuse must agree with the local AC line voltage from which the unit is powered.

<u>AC Line Voltage</u>	<u>Fuse Amperage</u>
100 V/120 V (50/60 Hz)	0.4 A
220 V/240 V (50/60 Hz)	0.2 A

Note: When the AC line voltage for the unit is changed after receipt of your super megohmmeter, check the fuse amperage.

GND Terminal: This is a ground terminal connected to the chassis of the unit.

External Input/Output Terminal Block: This terminal block carries signals measured result judgment outputs, optional DC output, and remote signal input.

For details, see the following sections;

6.5 Comparison and Judgment Function

8. MEMORY CONTROLLED MEASUREMENT

9.2 DC Signal Output

HV-EN (High Voltage Enable) Interlocking Connector: This connector is provided for connection of an external interlocking switch on the measuring jig designed to block the application of a high voltage across the Rx +/- measuring terminals for safety of the operator when the switch is in the off position.

If such a switch is not provided, keep this connector plugged with the accessory shorting plug, instead.

RS-232C Interface Connector: This connector is provided for RS-232C interfacing. For details, see 7. RS-232C INTERFACE CONNECTIONS.

4.3 Measuring Display

In the measuring mode, the LCD display shows the resultant measured resistance value and its NO/GO judgment, as well as the measuring voltage and time.

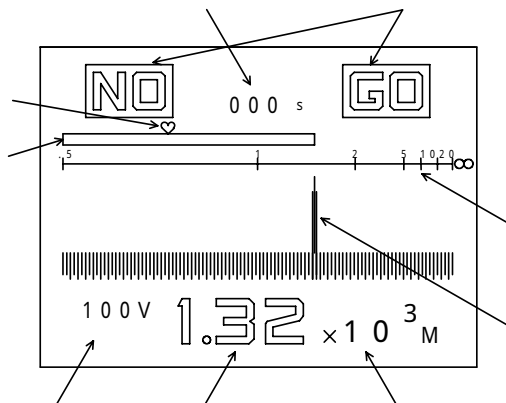

Fig. 4.3

Test Voltage Indication: This shows the test voltage set with the VOLTAGE selector switch.

Measured Resistance Indication: This shows the measured resistance in real time. When the measuring time is up, the final value is held until the next measurement will start.

Measuring Range Indication: This shows the measuring range set with the RANGE selector switch.

Analog Indicator: This shows the measured resistance value in analog referred to the analog resistance scale.

Analog Resistance Scale: This shows the scale for the analog indicator reading. When the measuring voltage is changed, the scale and values are changed, accordingly.

NO/GO Comparison Judgment Indication: When the NO/GO comparison judgment function is set on, a judgment of resultant resistance can be done referred to preset high/low limits. When the comparison judgment value is set to 000, the function becomes off.

Timer Count Indication: This is a count-down timer shown in seconds. When the timer is set to 000 sec., the function becomes invalid.

Comparison Judgment Value Mark: When the comparison judgment function is set on, a heart mark appears at a position showing the set value on the measured resistance bar graph.

Measured Resistance Bar Graph: This shows the measured resistance as a length of the bar.

4.4 Measuring Condition Setting Display

The LCD display showing the measuring condition setting.

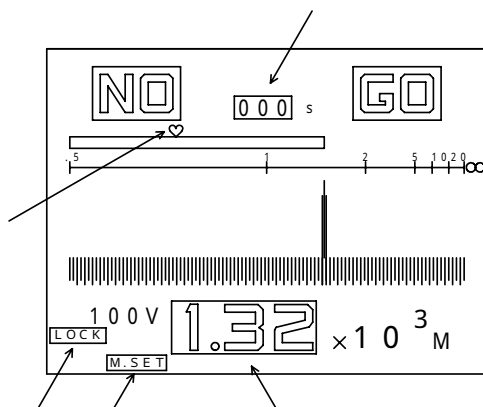

Fig. 4.4

Status and Mode Notice: When the MEASURE/DISCHARGE selector switch is set to the DISCHARGE position, press the SELECT switch to enter the setting mode, and the selected mode is shown in this box. Each time the SELECT switch is pressed, the mode is changed in the order; **C. SET** (voltage charging time setting mode) **M. SET** (measuring time setting mode) **COMP** (measured value comparison level setting mode) **BUZZ** (buzzer sound level setting mode) **[]** (blank - measuring display).

When the RANGE selector is set to the **CAL** position, **CAL1** is shown. With the **CAL1** status shown, the press of the SELECT switch changes the status to **CAL2**.

Highlighted Comparison and Judgment Value: When the COMP (comparison and judging level setting mode) is selected, the value is shown highlighted, and it can be changed with the UP and DOWN switches.

Comparison and Judgment Value Mark: This heart mark is shown when the comparison and judgment function is set to on, showing the position of the comparison and judgment level.

Highlighted Judgment value: This shows the judgment level which can be changed with the UP/DOWN switches.

LOCK (Interlocking) Notice: This shows that preparation for the measurement is not ready, yet. This notice is shown when the interlocking function is used to show that the HV-EN connector is free, and/or the Rx -/+ measuring terminals are free.

When the LOCK notice is shown, the MEASURE and CHARGE switches become inoperative.

4.5 Meanings of the Status and Mode Notices

This describes the meanings of the status and mode notice in the lower left corner of the LCD display.

- 1) **LOCK** (Interlocking): The test voltage applying circuit is interlocked, an measurement is not ready, yet. This notice is shown when the interlocking function is in use, but the HV-EN plug or measuring rod plug is not plugged into the connector.
When the LOCK is shown, the MEASURE and CHARGE switches become inoperative.
- 2) **CAL1** (Calibration-1): This is shown when the RANGE selector switch is set to the **CAL** position.
- 3) **CAL2** (Calibration-2): This is shown when the SELECT switch is pushed while the **CAL1** notice is shown.
- 4) **C. SET** (Measuring voltage charging time setting mode): The time can be adjusted within a range from 0 to 999 seconds.
- 5) **M. SET** (Measuring time setting mode): The time can be adjusted within a range from 0 to 999 seconds.
- 6) **COMP** (Comparison judgment value setting mode): The value can be set within a range from the minimum value for the range to 10 times the value.
- 7) **BUZZ** (Buzzer ON/OFF setting mode): The buzzer can be set ON or OFF when the resultant comparison judgment is NO.

5. PREPARATION FOR A MEASUREMENT



WARNING

Make sure, before turning the instrument on, that the VOLTAGE SELECTOR switches on the rear of the unit are properly set to the positions in agreement with the local AC line voltage. If the agreement is failed, the unit may break a fire or burning.



WARNING

Be sure to connect the ground prong of the power cord plug to prevent danger. If grounding of the ground prong is impossible, connect GND terminal to the ground post of the power line system.

Note: For safety, the measuring voltage cannot be output unless otherwise the accessory shorting plug is plugged into the HV-EN connector on the rear of the unit. During measurement, the shorting plug must be kept plugged in.



WARNING

Before trying to plug the shorting plug into the HV-EN connector, be sure to turn the POWER switch OFF.

5.1 Preparation

Confirm the setting of the instrument in the order shown below.

- 1) Confirm that the VOLTAGE SELECTOR switches on the rear of the unit are set to the positions in accordance with the local AC line voltage from which the unit is powered (See 1.3 Setting the VOLTAGE SELECTOR Switches.).
- 2) Confirm that the POWER switch of the unit is positioned at the OFF (released) position. Note that if the switch is in the ON position, it is depressed.
- 3) Plug the accessory power cord into the AC LINE receptacle on the rear of the unit. Also, plug the plug on the other end of the cord into the commercial AC line socket.

- 4) Confirm that the accessory shorting plug is inserted into HV-EN connector on the rear the unit.
- 5) Leave the Rx -/+ measuring terminals free at this stage – do not connect the measuring rods and the sample to be measured to the terminals.
- 6) Set the RANGE selector switch to the $\times 1$ position – the minimum Multiplier.
- 7) Set the VOLTAGE SELECTOR switches to the voltage to be applied to the sample.
- 8) Turn the POWER switch ON.
Allow the unit to warm for a minimum of 30 seconds to obtain the specified performance. However, a measurement can be done after a warm-up of several seconds.

5.2 Calibration

1) CAL1 Calibration* 1

Set the RANGE selector switch to the **CAL** position.

The LCD display shows the **CAL1** message in the lower left area of the screen. When the unit is normal, the measured value indication area should show a value within a range from **.970** (-3%) to **1.03** (+3%).

If the CAL2 calibration is not needed, set the RANGE switch to a position other than the **CAL**.

2) CAL2 Calibration* 2

To perform the CAL2 calibration, press the SELECT switch to start the CAL2, replacing the **CAL1** message with the **CAL2**.

Set the RANGE switch to the **$\times 10^2$** position.

When the 5-digit value indication on the LCD display is stabilized with its 5th place within a value of 4 peak to peak, the unit is normal.

To finish the CAL2 calibration, press the SELECT switch.

Example: The CAL2 calibration

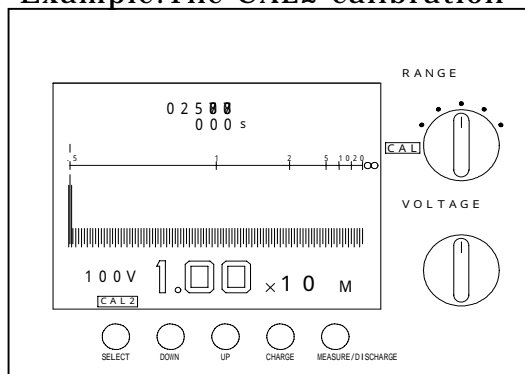

Fig.5.2.1

Note :

* 1 This function is intended to check the accuracy of the measuring voltage and the integrity of the current measuring circuit.

* 2 This function is intended to measure the offset. An offset value is stored in E²PROM and is subtracted from subsequent the measured value.

5.3 Basic Procedures for a Measurement

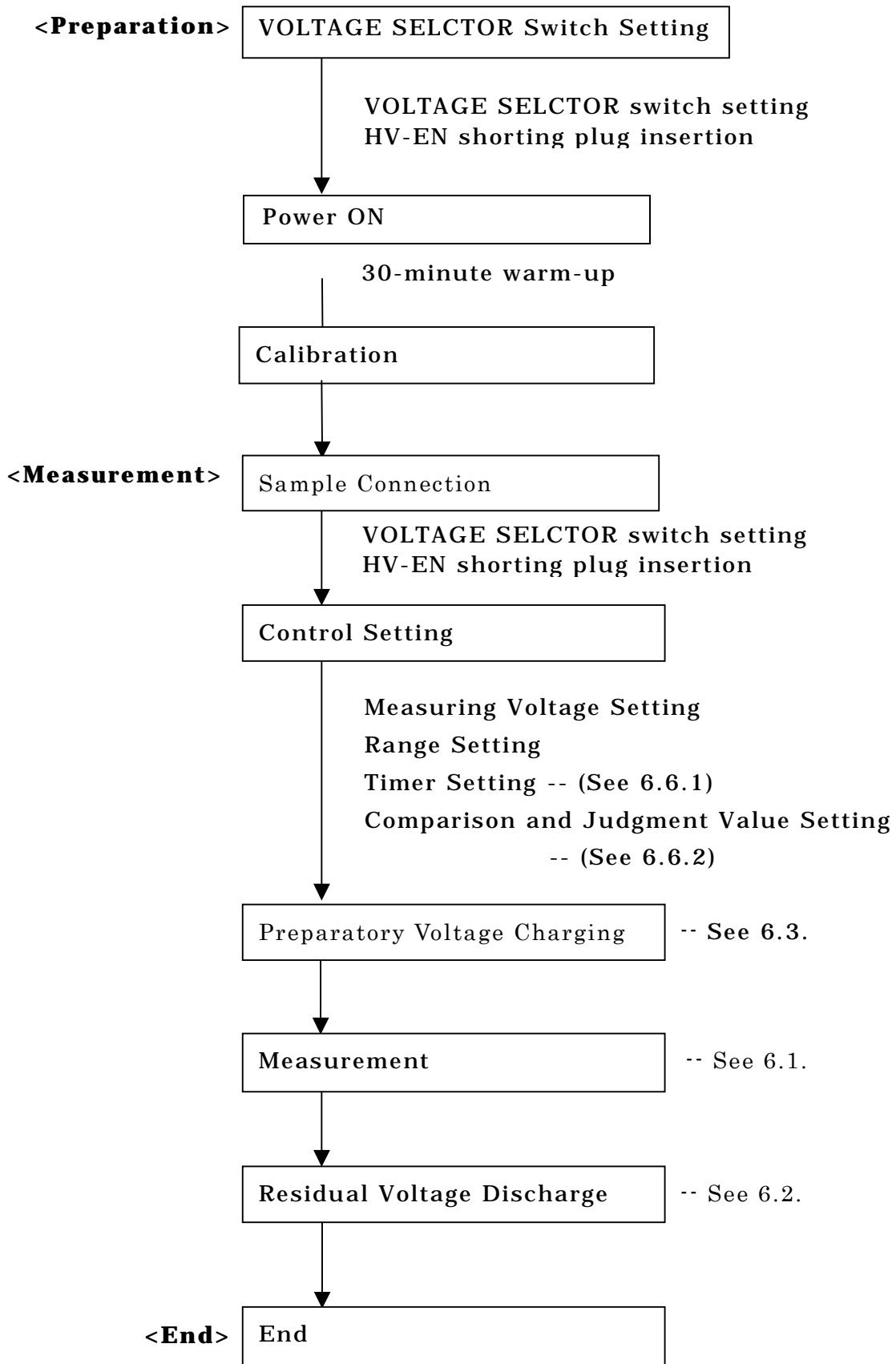

6. MEASUREMENT

6.1 Measuring Method

- 1) Plug the accessory measuring rods to the Rx +/- measuring terminals until they are stopped.

Red measuring rod to the Rx - measuring terminal

Black measuring rod to the Rx + measuring terminal

Note that each terminal has an incomplete plugging detection switch.

If the rod is incompletely plugged, the switch is left open, and the measuring voltage cannot be output.

- 2) Connect the measuring rods to the sample to measure.

Note 1: When one end of the sample is grounded, connect the black measuring rod to the grounded end. (See Fig. 6.1.1.)

Note 2: When one end of the sample has a larger surface area which is exposed to atmosphere than the other end, connect the black measuring rod to such an end. (See Fig. 6.1.2.)

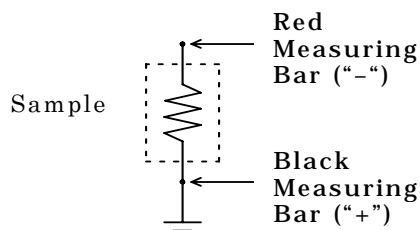

Fig. 6.1.1

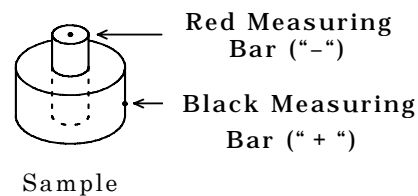

Fig. 6.1.2

- 3) Set the VOLTAGE selector switch to the voltage to be used for the measurement.
- 4) Set the RANGE selector switch to the range to be expected. If there is no idea about the approximate insulation value of the sample, set the selector to the $\times 1$ range. Press the MEASURE switch to start a measurement. Change the position of the RANGE selector switch to find the most appropriate position to read the measured value. If the selector is set to a position out of the measured value, the indicated value is shown blinking.

Note 1: When the analog indicating needle is shown leftward, select a larger range, while if the needle is shown rightward, select a smaller range.

Note 2: To measure a capacitive sample within a possible shortest time, press the CHARGE switch to change the sample as much as possible. Then, press the MEASURE switch to start a measurement. During the measurement, the measured value will be changed with time. In such a state, the elapsed time after voltage charging

becomes a significant parameter for the measuring conditions. In most cases, the value of 1 minute after voltage charging is read as a 1 minute rate value. The integrated timer can determine the value at 1 minute after voltage charging. For details, see 6.6.

Note 3: When a measuring jig is used, it is recommended to provide an interlocking switch with it for safety. For the interlocking, utilize the HV-EN (high voltage enable) socket on the rear of the unit. This makes it possible to disarm the jig when the cover of the jig is opened. For details, see 6.4.

6.2 Discharge Function

This function is intended to discharge the charge on the sample connected to the Rx -/+ measuring terminals. Discharging is automatically performed each time the super megohmmeter is turned on, and the measurement is ended. The sample after measurement must be disconnected from the terminals after the discharging function is performed.

Status of the MEASURE/DISCHARGE switch can be known by the indicator.

Indicator ON ----- MEASURE
OFF ----- DISCHARGE

In the DISCHARGE status, a resistor of approx. 100 k Ω is internally inserted to discharge the charge of the sample.

A time required to discharge the charge of the sample depends on the capacitance of the sample. When the capacitance of the sample is 1 μ F, it takes approx. 5 seconds to reduce the residual voltage down to 5% of the charged value.

Note: The discharge function does not work if the POWER switch is kept OFF.

6.3 Charge Function

To measure a capacitive sample, charge it with the measuring voltage by pressing the CHARGE switch. Then, the charge of the sample is completed within several seconds.

There is no rule to determine the charging time, it is necessary to set it to a fixed time to make the measuring conditions unchanged among samples.



WARNING

When the super megohmmeter is in the charge status do not touch the Rx -/+ measuring terminals and the sample being charged. The measuring voltage selected with the VOLTAGE switch is directly applied to these parts because there is a fear of electrical shock.

6.4 Interlocking Function - Using the HV-EN Connector

The super megohmmeter generates a high voltage to be used as a testing power source. It is dangerous if this measuring voltage is output to the sample not ready for measurement, yet. To protect the operator from a hazard of electrical shock, the HV-EN (high voltage enable) connector is provided on the rear of the unit to provide an interlocking function in combination with a measuring jig.

If a measurement does not use a jig with an interlocking mechanism, keep the HV-EN connector plugged with the accessory shorting plug.

Usage of the HV-EN Connector for Interlocking

Connect the HV-EN connector to a switch to be actuated by the interlocking mechanism of a measuring jig via an optionally available HV-EN plug connected with a cord. Fig. 6.4.1 shows an example interlocking circuit.

The optional accessories shown below have a safety interlocking switch.

SME-8310 - Electrode for plate samples

SME-8311 - Electrode for plate samples

SME-8350 - Shield box

Connect the plug at the end of the measuring cord of the optional accessory to the HV-EN connector on the rear of the unit.

For connection of a customer designed measuring jig to the HV-EN connector, use an optional HV-EN plug.

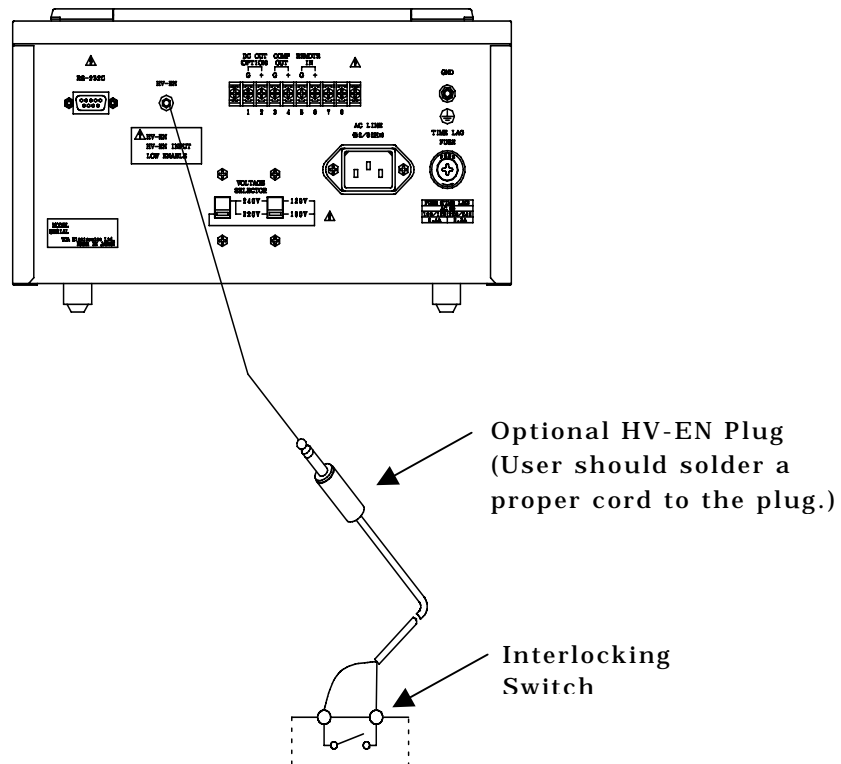

Fig. 6.4.1

6.5 Comparison and Judgment Function

This function is provided to sound a built-in buzzer, and turn on the COMP OUT G/+ terminals when the measured insulation resistance is lower than the preset judgment value and make the COMP OUT G/+ terminals are of open collector as shown as an equivalent circuit in Fig. 6.5.3. Use this circuit within the conditions shown below:

Voltage: 50 V or less

Current: 50 mA or less

Fig. 6.5.1 shows a circuit diagram for connection with the COMP OUT terminals.

Fig. 6.5.2 shows the external input/output terminal block, including the COMP OUT G/+ terminals.

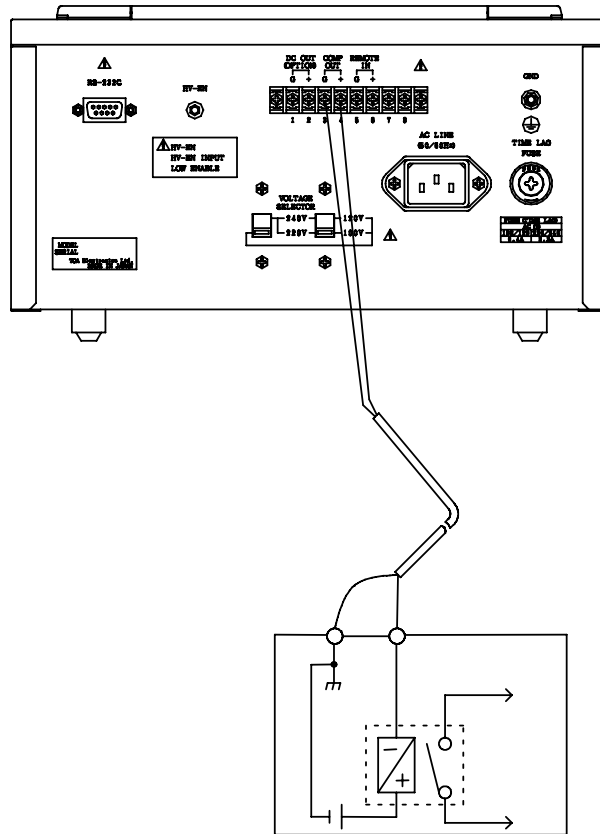

Fig. 6.5.1

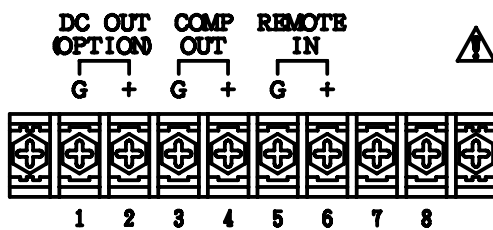

Fig. 6.5.2

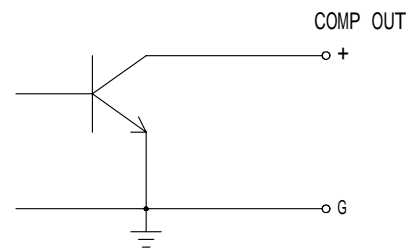

Fig. 6.5.3

6.6 Setting a Variety of Functions

A variety of useful functions can be set when the RANGE selector switch is set to any position other than the **CAL**, and by using the SELECT, UP and DOWN switches.

Each time the SELECT switch is pushed, the LCD display is changed in the order of the **Measuring Display** **C. SET** **M. SET** **COMP.** **BUZZ** **Measuring Display**.

C. SET: Charging timer setting

M. SET: Measuring time setting

COMP.: GO/NO judgment level setting

BUZZ: Buzzer sound ON/OFF setting

6.6.1 Setting the Timer

Example: Setting a measuring time to 50 seconds

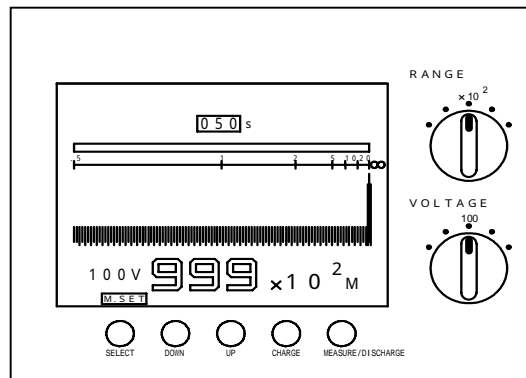

Fig. 6.6.1

- 1) Press the SELECT switch twice to show the **M. SET** indication in the lower left area of the LCD for the measuring timer setting mode.
- 2) Using the UP and DOWN switches, set the time indication in the upper center area of the display to **050** seconds.
- 3) Press the SELECT switch 3 times to return to the measuring display. To accelerate the change of a value, keep the corresponding UP or DOWN switch pushed.

6.6.2 Setting the Comparison GO/NO Judging Level

Example: Setting a judgment of NO<100M GO for 100 V test voltage

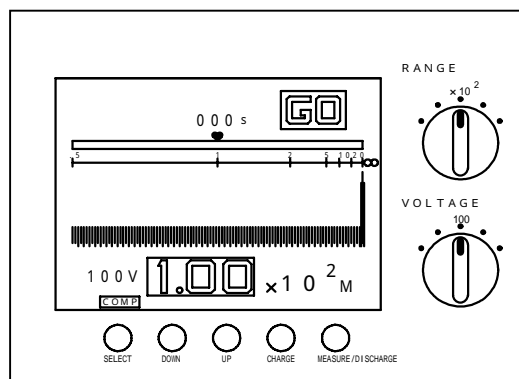

Fig. 6.6.2

- 1) Set the VOLTAGE selector switch to 100 V.
 - 2) Set the RANGE selector switch to $\times 10^2$.
 - 3) Press the SELECT switch 3 times to show the **COMP** indication in the lower left area of the LCD for the comparison GO/NO judgment level.
 - 4) Using the UP and DOWN switches, set the GO/NO judgment level to $100 \times 10^2 M$.
 - 5) Press the SELECT switch twice to return to the measuring display.
- To accelerate the change of a value, keep the corresponding UP or DOWN switch pushed.

Note: The comparison GO/NO judgment level setting can be effective for the currently set RANGE and VOLTAGE values, only. If setting is required for other RANGE and VOLTAGE values, set desired RANGE and VOLTAGE, first.

6.6.3 Setting Buzzer Sound ON/OFF

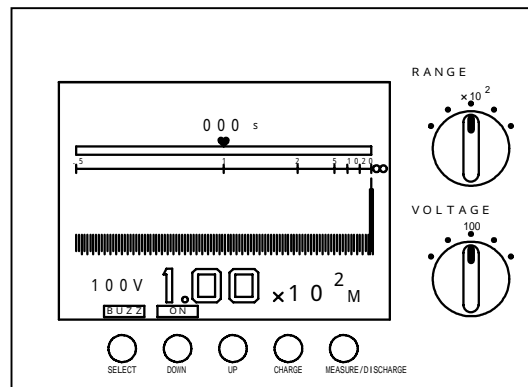

Fig. 6.6.3

- 1) Press the SELECT switch 4 times to show the BUZZ indication in the lower left area of the LCD for the buzzer sound ON/OFF setting.
- 2) Using the UP and DOWN switches, set **ON** or **OFF**.
- 3) Press the SELECT switch once to return to the measuring display.

6.6.4 Setting Charging Time, Measuring Time, Comparison GO/NO Judging Level and Buzzer Sound ON/OFF

Example: Setting for measuring conditions below:

Charging Time: 10 seconds

Measuring Time: 50 seconds

Comparison Level: NO<100M GO judgment

Buzzer Sound: Buzzer sounds when NO judgment is resulted.

RANGE Position: $\times 10^2$

VOLTAGE Position: 100 V

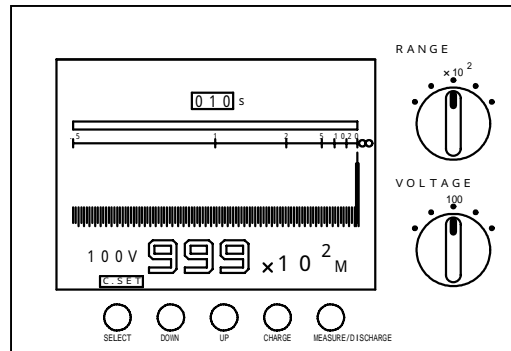

Fig. 6.6.4

- 1) Set the VOLTAGE selector switch to **100 V** .
- 2) Set the RANGE selector switch to **$\times 10^2$** .
- 3) Press the SELECT switch to show the **C. SET** indication for charging time setting mode.
- 4) Using the UP or DOWN switch, set the charging time to **010** seconds. (Fig. 6.6.4)
- 5) Press the SELECT switch to enter the value of 010. This action provides the measuring time setting mode, showing the **M. SET** indication.
- 6) Using the UP and/or DOWN switches, set the measuring time to **050** seconds.
- 7) When this value is OK, press the SELECT switch to enter it. This action provides the judgment level setting mode, showing the **COMP** indication.
- 8) Using the UP and/or DOWN switches, set the judgment level to **100×10^2 M** . (Fig. 6.6.2)
- 9) When this level is OK, press the SELECT switch to enter it. This action provides the buzzer sound on/off setting mode, showing the **BUZZ** indication.
- 10) Using the UP and/or DOWN switches, set **ON** or **OFF** for the buzzer. (Fig. 6.6.3)
- 11) Press the SELECT switch to end the measuring condition setting mode, and go back to the measurement screen.

After setting the measuring conditions as shown in the example, press the CHARGE switch. Then, the measurement starts after a charging period of 10 seconds.

Note 1: The set measuring conditions are stored in the memory, and the contents are kept backed up even if the power is turned off.

Note 2: The comparison judgment level settings are valid only for the range and test voltage used for setting. For other ranges and test voltages, change the settings, accordingly.

6.7 Changes in the Current Flowing through an Insulator

In insulation resistance measurements, a large amount of current flows upon the application of the test voltage to the insulator. The current gradually reduces its value with time, but it takes a time until the value becomes stable and fixed. This phenomena is due to the combination of the charging current, absorption current, and leakage current, and it is generally called dielectric absorption phenomena. The equivalent circuit of an insulator is considered as shown in Fig. 6.7.1.

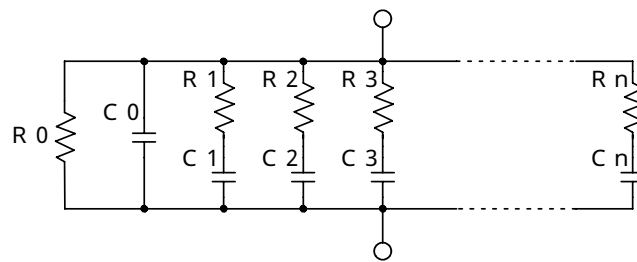

Fig. 6.7.1

When a voltage is applied to the circuit, a charging current flows through a bank of capacitors, $C_0, C_1, C_2, \dots, C_n$. Firstly, C_0 is charged, and other capacitors follow. As the charging progresses the current through R_0 constantly flows as shown in Fig. 6.7.2.

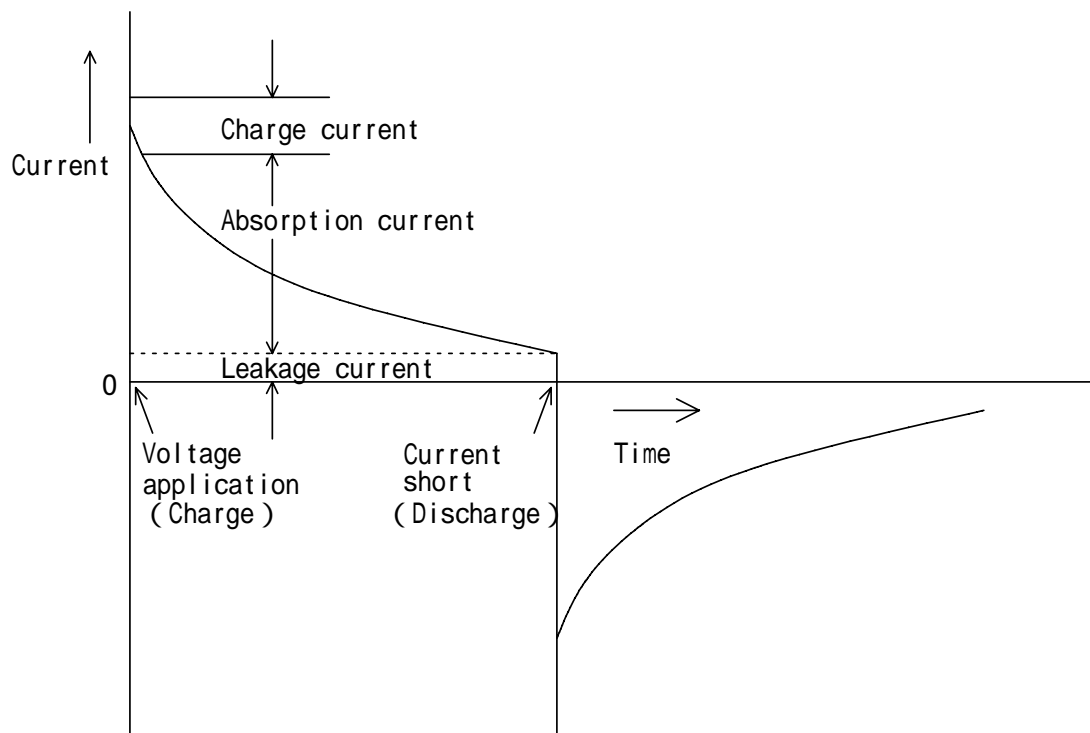

Fig. 6.7.2

R_0 is an insulation resistance to be measured, but, $C_0, C_1, C_2, \dots, C_n$

Have series resistors $R_0, R_1, R_2, \dots, R_n$. Therefore, a measurement of R_0 only is very difficult. It is said that, with some insulation resistance measurements, it takes several hours to a few days for the leakage current to stabilize. This is not practical.

To avoid this problem, a method is customarily used in the insulation resistance measurement for convenience to read the resistance value one minute after charging the test voltage to the sample. This value is called minute rate value for the resistance value of an insulator, and is widely employed among a variety of electrical standards.

In the 1-minute rate insulation resistance measurement, the measured values may vary when a measurement is repeated once or twice with the same sample. To minimize such a deviation, it is important to completely discharge the sample before the start of each measurement. The required discharge time mainly depends upon the charging voltage and the size of C_0 in Fig. 6.7.1, but, generally it can be said to be 5 to 6 times longer than the time of test voltage charging.

7. RS-232C INTERFACE

7.1 RS-232C Communication Commands

Mnemonic	Contents	Format
R	Measuring Data Output	Format: R ^{C_R L_F} Response: ****E*, Judgment [GO] 0 or [NO] 1 Example: 10.0E4, 0 ^{C_R L_F}
M	Starting a Measurement	Format: M ^{C_R L_F} Response: 0 (valid) or 1 (invalid)
C	Starting a Charging	Format: C ^{C_R L_F} Response: 0 (valid) or 1 (invalid)
S	Stopping Forcedly	Format: S ^{C_R L_F} Response: 0 (valid) or 1 (invalid)
T	Measuring Time Setting	Format: T *** (000 to 999) ^{C_R L_F} Example: T 60 ^{C_R L_F} Response: 0 (valid) or 1 (in valid)
G	Charging Time Setting	Format: G *** (000 to 999) ^{C_R L_F} Example: G 120 ^{C_R L_F} Response: 0 (valid) or 1 (in valid)
P	Judgment Level Setting	Format: P *** (000 to 999) ^{C_R L_F} Example: P . 100 ^{C_R L_F} Response: 0 (valid) or 1 (in valid)
B	Judgment Buzzer Setting	Format: B [OFF] 0 or [ON] 1 ^{C_R L_F} Example: B 1 Response: 0 (valid) or status
U	Measuring Condition Output	Format: U ^{C_R L_F} Response: Range, Voltage, interlocking, Status Example: 4, 1000, 0, 2 ^{C_R L_F} Range: 0 to 8 Voltage: 5 to 1000 Interlocking: 0[OFF]/1[ON] Status: Stand-by - 2 Under measurement - 3 Charging - 4 On setting - 5 Under calibration - 6 Timer in operation - 7
I	Instrument ID	Format: I ^{C_R L_F} Response: Model, Version Example: SM-8215V1.00 ^{C_R L_F}

Baud Rate	9600 bps
Data Bit	8 bit
Parity Bit	None
Stop Bit	1 bit
Flow Control	RTS/CTS possible

7.2 Applications of Commands

- 1) After each command transmission, make sure to receive the response.
- 2) For R command, a state only response will be received, depending upon the conditions at such a time.

Even during measurement, a state 7 only response will be received when the timer is functioning.

During stand-by, measured data are transmitted once. A command invalid will be transmitted except for after re-measurement.

- 3) If a charging time is set upon receipt of a C command, a measurement is started as soon as the charging is completed.
- 4) For a P command, if a value out of the specified measuring range is received without an actual setting.

7.3 Connector Specifications

Type of Connector: HDBE-9PF (05) [Hirose]

Type of Lock Fitting - HD-LNA (4-40), inch type

Pin Arrangement:

Pin No.	Signal Line	Direction of Signal Flow		Application
		Megohmmeter	External Unit	
1	NC			No connection
2	TD		→	Transmission data
3	RD	←		Receiving data
4	NC			No connection
5	SG			Signal ground
6	ER		→	Data peripheral ready
7	CS	←		Send ready signal
8	RS		→	Send request signal
9	NC			No connection

Example of Connections

- 1) For connection with a DOS/V personal computer, use a straight 9-pin to 9-pin cable.

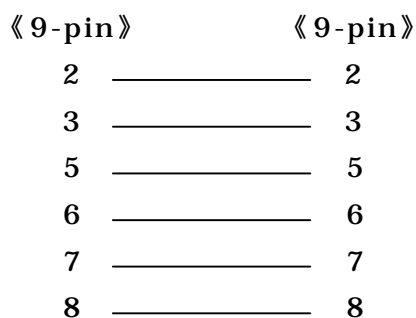

- 2) For connection with an NEC PC-9801 Series personal computer, use a straight 9-pin to 25-pin cable.

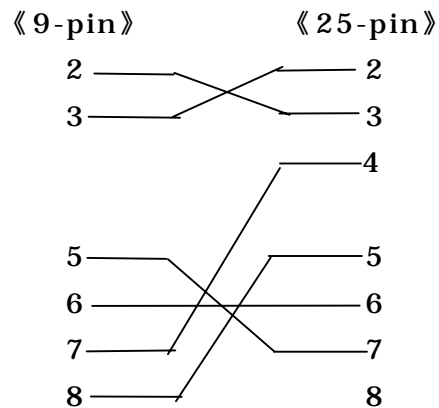

7.4 Printer Output

Via the RS-232C interface, measured data can be output to an optional printer, 0KC00001.

[Printer Output Procedures]

- 1) Connect the RS-232C interface connector on the rear of the unit, to the optional printer via the dedicated connection cord.
- 2) Set the measuring intervals as needed. (See Fig. 6.6.1.)
- 3) Press the MEASURE switch.
- 4) When the measurement is completed, the measured data are output to the printer.

Example:

Measured Data - 10.0×10^4 M , GO judgment

Printing - 10.0E4, 0

8. Remotely controlled measurement — Supplement —

Indication of numeric and GO/NO judgement are conducted after converting analog input to digital signal.

Since it takes approx. 200mS to process analog/digital conversion, measuring result does not come out actually, if the remote signal is input in a shorter time than it.

In the process of detecting the remote signal, if the signal does not keep for approx. 60ms or more from the variation point of remote signal in order to cancel the noises and chattering, it is not treated as effective one.

As a result, it will take approx. 260ms from the remote signal ON to output of measuring result and during this time it is needed to keep remote signal ON.

When measurement is completed by turning remote signal off, it is not treated as normal OFF input signal if it is not kept approx. 60 ms or more.

When remote signal ON or OFF time is less than 60ms, it will be not received or lead to miss-operation.

When remote signal is used, care must be taken to input the signal for 260ms or more at ON, while 60ms or more at OFF.

Note 1: When the measuring time is set with the incorporated timer, the timer has a priority over a remotely controlled switch actuation.

When the REMOTE IN “G” and “+” terminals are closed, a measurement will start. The measurement will automatically end when the time set with the timer is up.

Note that when the closed “G” and “+” terminals are opened before the time-up of the timer, the opening of the “G” and “+” terminals has a priority over the time set with the timer.

Note 2: When the charging time is set with the incorporated timer, the timer has a priority over a remotely controlled switch actuation.

When the REMOTE IN “G” and “+” terminals are closed, a charging will start. The measurement will automatically start when the charging time set with the timer is up.

Note that when the closed “G” and “+” terminals are opened before the time-up of the timer, the opening of the “G” and “+” terminals has a priority over the time set with the timer.

Note 3: When both the charging time and measuring time are set with the incorporated timer, the timer has a priority over a remote control.

When the REMOTE IN “G” and “+” terminals are closed, a charging will start.

When the set charging time is up, a measurement automatically starts. However, note that when the “G” and “+” terminals are opened before the set measuring time is up, the remote control has a priority over the time set with the timer.

When the set measuring time is up, a measurement automatically ends. However, note that when the “G” and “+” terminals are opened before the set measuring time is up, the remote control has a priority over the time set with the timer.

9. INTRODUCTION OF OPTIONS

With the SM-8200 Series super megohmmeters, any of the following options can be provided as needed. However, note that some of them can be installed at factory.

9-1 Guard Tip

1) Applications

1)-1 In a measurement of the insulation resistance of a capacitive sample, the optional guard tip is used as a charging tip.

1)-2 In a measurement of the high insulation resistance, the optional guard tip is used to guard the sample from the surface current of the sample support made of insulation materials to obtain more reliable data.

2) Usage

2)-1 Charging Tip

(1) Before connecting the measuring plug of the red measuring rod to the Rx “-“ terminals, mount the guard tip on the measuring plug as shown in Fig. 9.1.1.

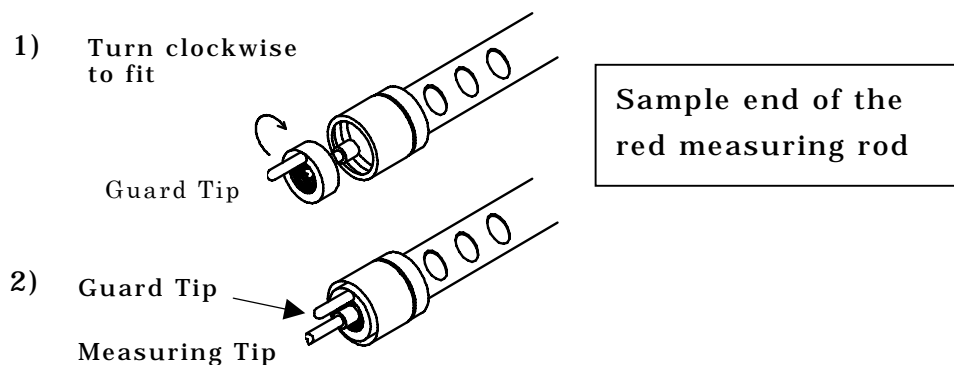

Fig. 9.1.1

(2) After mounting the guard tip, connect the measuring rod to the Rx “-“ measuring terminals.

(3) Connect the black measuring rod to the sample to measure.

(4) Press the MEASURE switch.

(5) Connect the guard tip of the red measuring rod to the sample to charge.

(6) When an appropriate period (See Note.) of charging time has passed, connect the measuring tip of the rod to the sample in place of the guard tip.

Note 1: When changing the guard tip connection to the measuring tip connection, a spark may occur, depending upon the capacitance of the sample.

Note 2: There is no technical standards available to specify the charging time for samples, but a constant time should be always applied to a specific type of samples, and such a time should be recorded for later reference.

2)-2 Leakage Guard

- (1) Before connecting the measuring rods to the Rx -/+ measuring terminals, mount the guard tip onto the red measuring rod as shown in Fig. 9.1.1 on the previous page.
- (2) Connect the measuring rods to the Rx -/+ measuring terminals.
- (3) Connect the sample as shown in Fig. 9.1.2 below.

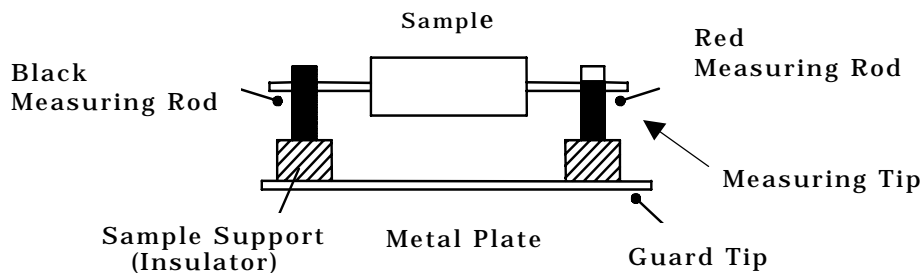

Fig. 9.1.2

- (4) Press the MEASURE switch to start the measurement.



DANGER

Do not touch the Rx -/+ measuring terminals and the connected sample when the unit is in the MEASURE or CHARGE mode because they carry the voltage set with the VOLTAGE selector switch. It is electric shock hazardous.



CAUTION

For safety, unplug the measuring rod from the Rx -/+ measuring terminals before disconnecting the guard tip from the sample.

-- to be continued --



DANGER

Use utmost care when handling a capacitive sample connected to the Rx -/+ measuring terminals because the a capacitive sample's internal impedance is low, and a touch of the voltage applied parts of the sample may discharge the charge of the sample at a time, giving a strong shock to the operator.

This is especially dangerous when the test voltage is high and the capacitance of the sample is large.

This suggests, after measurement, to discharge the charge of the sample without a fail.

9.2 DC Signal Outputs

Either one of two different types of DC signal outputs can be optionally installed with the unit at factory. The output can be used to make a permanent record of measured data by connecting a chart recorder such as the HIOKI EPR-3000 Series.

One of the outputs provides a linear DC signal directly proportional to the measured resistance (RP-8000), and the other outputs a 1/R DC signal which is inversely proportional to the measured resistance (RI-8000).

9.2.1 DC Output, RP-8000 – Directly proportional or linear to resistance

An insulation resistance can be obtained when the measuring voltage is divided by the current flowing through the circuit. When the measuring voltage is constant, if the insulation resistance is doubled, the current flowing through the circuit is halved. The RP-8000 DC output is designed to convert the measured insulation resistance into a DC signal directly proportional to the resistance.

1) Specifications

Output Range: From full scale of the super megohmmeter to 10 times full scale

Output Voltage: 1V/full scale, 10 V/10 times full scale

Output Accuracy: Within $\pm 10\%$ full scale

2) Usage

Measure the insulation resistance of a sample with the method designed in 6.1 Measuring Method. There is no limitation in the applications in relation with the provision of the RP-8000 DC output. Fig. 9.2.1 on the next page illustrates an example connection with the HIOKI EPR-3000 Series chart recorder.

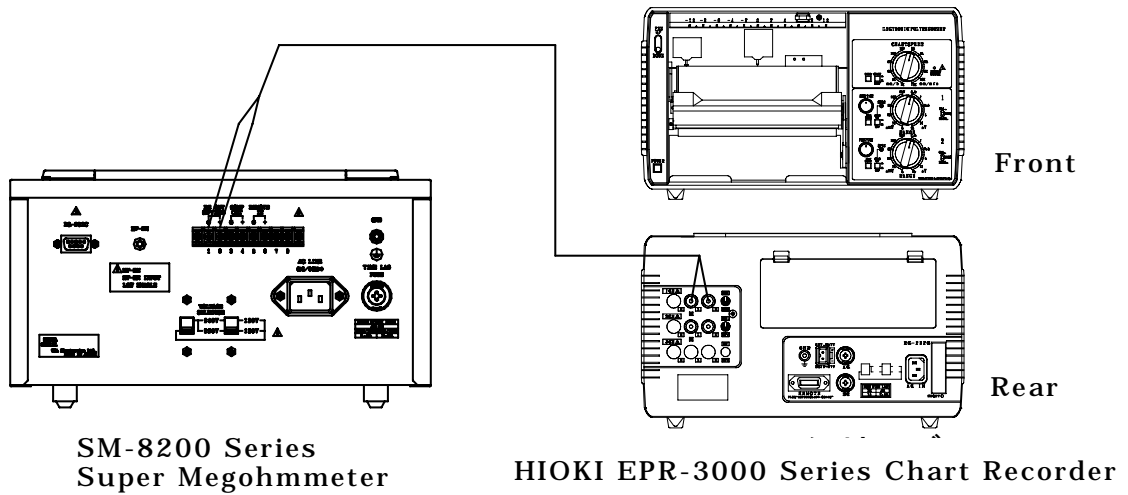

Fig. 9.2.1

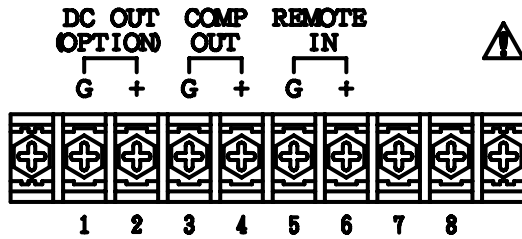

Fig. 9.2.2

Fig. 9.2.2 shows the DC OUT (OPTION) “G”/”+” terminals on the external input/output terminal block on the rear of the unit.

A DC measuring instrument like a HIOKI chart recorder can be connected to these terminals. For permanent data recording, a HIOKI chart recorder is recommended for better technical follow-up, including a supply of a variety of recording charts and technical service.

Fig. 9.2.3 shows the chart for the HIOKI EPR-3000 Series chart recorder (0 to 10 V full span) whose measuring range is set to ± 5 V, and the -5 V point is set to the zero (left most) line of the chart.

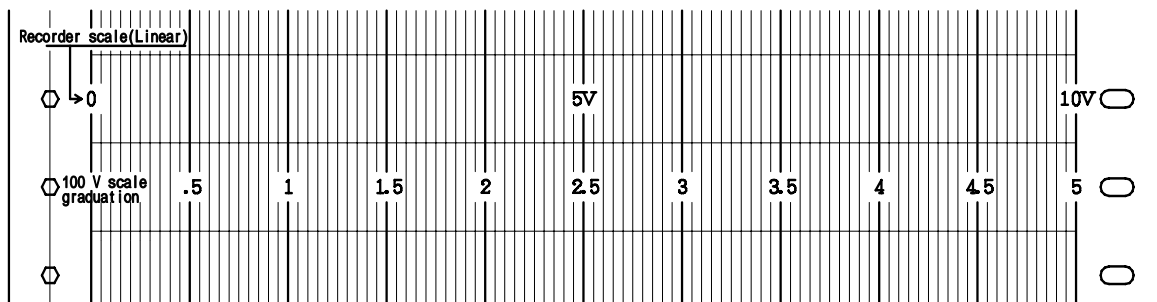

Fig. 9.2.3

9.2.2 DC Output, RI-8000 – 1/R or inversely proportional to resistance

In insulation resistance, as described in 9.2.1 DC Output, RP-8000, if the measuring voltage is constant, the current flowing through the sample is halved, and the output voltage is also halved when the insulation resistance -- R -- is doubled. This relation can be expressed as “1/R.”

The RI-8000 provides this type of DC signal output.

1) Specifications

Output Range: Full range of the measuring range of the SM-8200 Series super megohmmeter

Output Voltage: 10 V/full scale, 1 V/10 times full scale

Output Accuracy: Within 10% of displayed value in the range from full scale to 10 times full scale

2) Usage

Measure the insulation resistance of a sample with the method designed in 6.1 Measuring Method. There is no limitation in the applications in relation with the provision of the RP-8000 DC output. Fig. 9.2.1 on the previous page illustrates an example connection with the HIOKI EPR-3000 Series chart recorder.

Fig. 9.2.2 on the previous page shows the DC OUT (OPTION) “G”/”+” terminals on the external input/output terminal block on the rear of the unit.

A DC measuring instrument like a HIOKI chart recorder whose input impedance is greater than 10 MΩ can be connected to these terminals. For permanent data recording, a HIOKI chart recorder is recommended for better technical follow-up, including a supply of a variety of recording charts and technical service.

Fig. 9.2.3 shows the chart for the HIOKI EPR-3000 Series chart recorder (0 to 10 V full span) whose measuring range is set to ±5 V, and the -5 V point is set to the zero (left most) line of the chart.

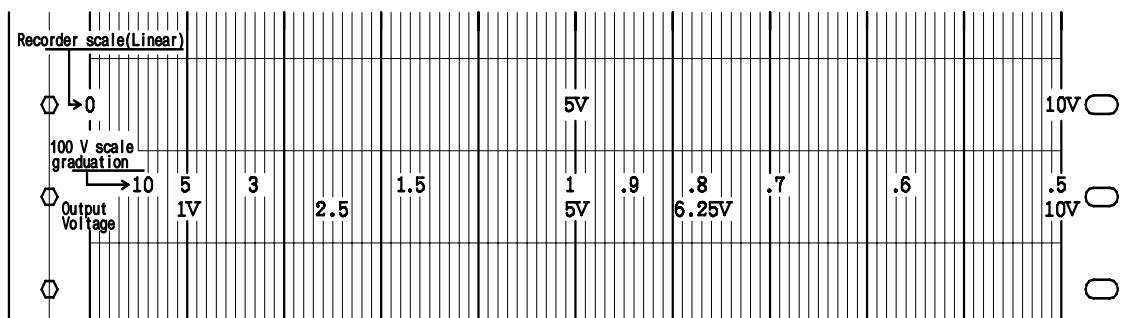

Fig. 9.2.4

10. MAINTENANCE AND MISCELANEOUS

Periodical maintenance, including checking and calibration is required for the MS-8200 super megohmmeter to perform reliable measurements and prevent a trouble and accident.

If necessary, ask your dealer or Hioki representative to do such a service as periodical checking, calibration and routine maintenance.

10.1 Periodical Checking

To keep your instrument its at best condition, the following checking is required at monthly periods.

1) Check the Rx measuring terminals and input/output terminal block for integrity.

As the Rx measuring terminals carry a high voltage (100 V to 1000 V, maximum, depending upon the model and set-up, visually check the terminals for any crack, loose connection, etc.

Crack and loose connection will lead a trouble and accident.

2) Clean the panels, Rx measuring terminals, and input/output terminal board with soft cloth.

3) Visually check the LCD display for brightness and clearness.

4) Check the action of the switches and pushbutton switches for smooth and trouble-free operation.

5) Measure the measuring voltage across the Rx -/+ measuring terminals With a voltmeter. The voltage should be within $\pm 3\%$ of the selected value.

10.2 Storage, Transportation and Abandon

1) Storage

When the SM-8200 Series unit is shutdown for a long period of time, unplug the power cord from the AC line outlet, put a dust cover over it, and store the unit in a place meeting the following conditions.

(1) Free of corrosive gas, dust and vibration

(2) Environment temperature of 5 to 45 °C, less than 85% RH

2) Transportation

When the unit is transported, avoid shock and vibration.

For long distance transportation, place the unit in a shock absorbing carton box with a HANDLE WITH CARE label to prevent rough handling.

3) Abandon

To abandon an old unit, observe the rules of your local government.

11. EXTERNAL APPEARANCE

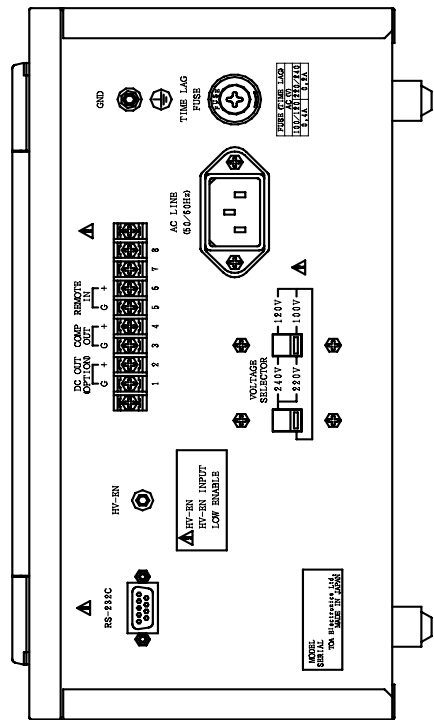
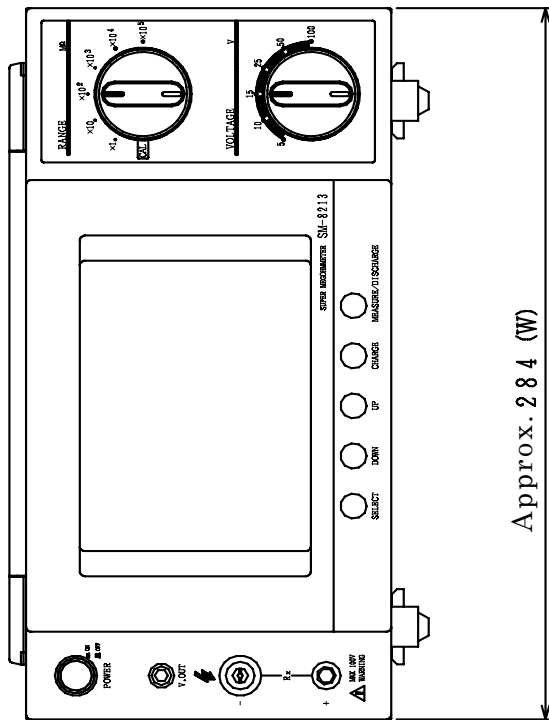
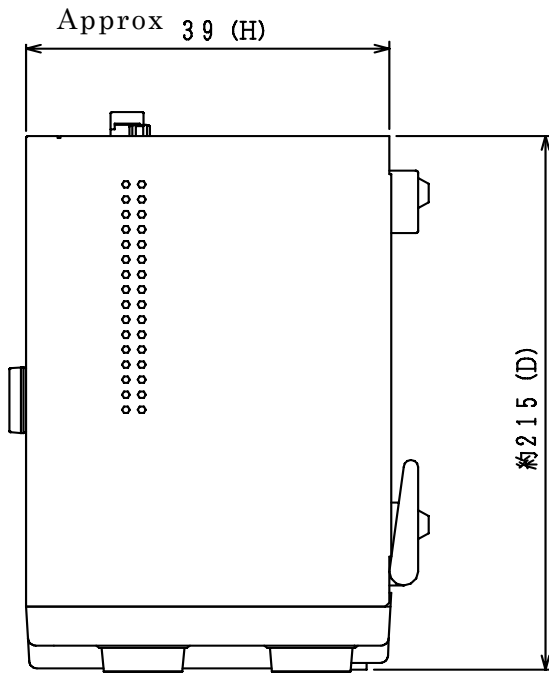

Unit: mm

HIOKI SM-8213, 8215, 8220 SUPER MEGOHMMETER
Instruction Manual

Publication date: November 2006 Edition 1

Printed in Japan SM8213A981-00

-
-
- All reasonable care has been taken in the production of this manual, but if you find any points which are unclear or in error, please contact your supplier or the International Sales and Marketing Department at HIOKI headquarters.
 - In the interests of product development, the contents of this manual are subject to revision without prior notice.
 - Unauthorized reproduction or copying of this manual is prohibited.
-
-