

# PD6100

PROVU® Strain Gauge, Load Cell & mV Meter



**PROVU®**  
SERIES

**SUPER-BRIGHT LEDs**  
Our Brightest Display Ever

**MeterView Pro**  
USB Install



**STRAIN GAUGE**

- 15, 30, 150, 300 mV Unipolar Input Ranges
- $\pm 15$ ,  $\pm 25$ ,  $\pm 150$ ,  $\pm 250$  mV Bipolar Input Ranges
- Selectable 5 or 10 VDC Sensor Excitation @ 350 mA Maximum Sensor Excitation
- Supports up to twelve (12) 350  $\Omega$  Load Cells
- Capture or Programmable Tare Feature
- Auto-Zero Feature Eliminates Zero Drift
- Ratiometric Operation
- Max/Min or Peak/Valley Hold Feature
- Large Dual-Line 6-Digit Display, 0.60" & 0.46"
- Optional SunBright Display Models for Outdoor Applications
- Dual-Scale Feature – Single Input
- Rounding Function 1, 2, 5, 10, 20, 50, or 100
- Programmable Display & Function Keys
- 32-Point Linearization
- NEMA 4X, IP65 Front
- Input Power Options Include 85-265 VAC or 12-24 VDC
- 2 or 4 Relays + Isolated 4-20 mA Output Options
- External 4-Relay & Digital I/O Expansion Modules
- RS-232, & RS-485 Serial Communication Options
- Modbus® RTU Communication Protocol Standard
- Onboard USB and MeterView® Pro Programming Software

**PRECISION  
DIGITAL**

# PD6100 ProVu® Strain Gauge, Load Cell & mV Meter



UV Resistant  
Sunlight Readable Models



Front Panel  
NEMA 4X Rated

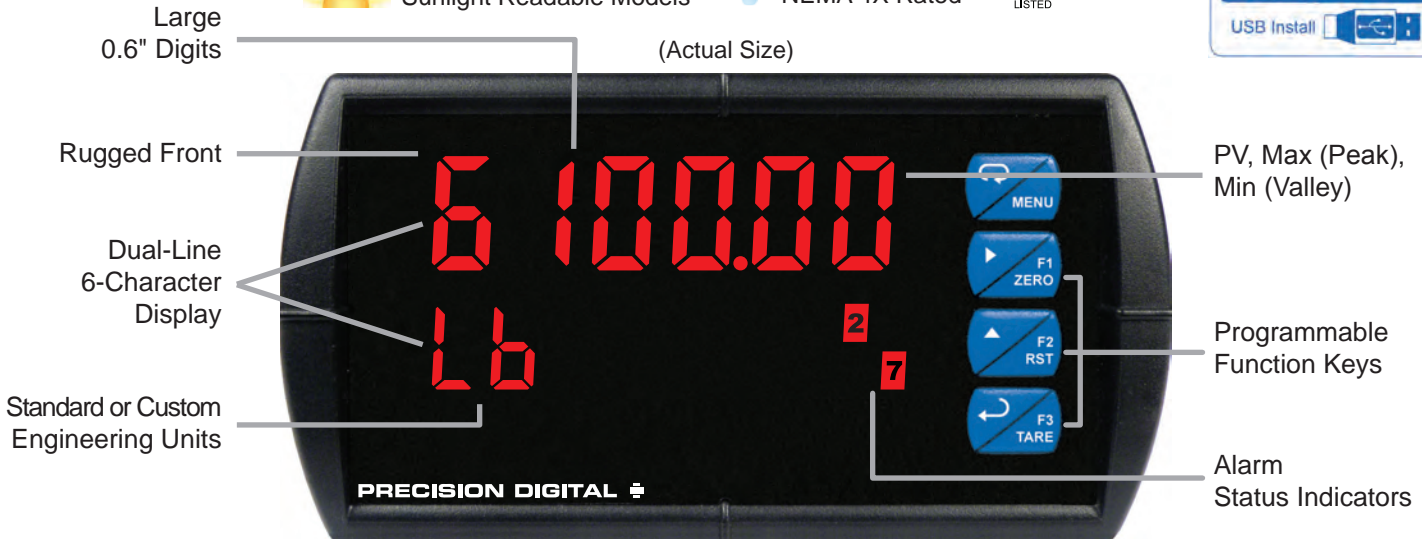

## FEATURE RICH AND FLEXIBLE

The ProVu® PD6100 is a full-featured multipurpose, easy-to-use digital strain gauge & load cell meter ideal for weight and force measurement applications. With a max current of 350 mA at 10 V, it can support up to twelve (12) 350 Ω load cells (minimum load resistance of 28 Ω), making it ideal for multipoint weight measurement applications. It accepts mV input signals up to 300 mV (unipolar) and ± 250 mV (bipolar). The PD6100's powerful dual-scale capability allows the measurement to be displayed in two different units of measure.

## KEY FEATURES

### Precise, Accurate, and More Informative

ProVu's large 0.6" upper display provides a highly accurate and precise 6-digit view of the process measurement. Its 24-bit A/D is accurate to ±0.03% of calibrated span ±1 count.

## Standard LED and Optional SunBright LED Display Models

The ProVu's standard and SunBright display models feature extraordinarily bright LED displays. They are perfect for indoor and outdoor applications where visibility may be impaired by smoke, fog, dust, or distance. The intensity on the SunBright display model is so high it can be read even in the brightest sunlight.

## Function Keys

There are three function keys available to the user. These keys can be programmed to trigger certain events (i.e. acknowledge alarms, reset max and/or min, disable/enable output relays, or hold current relay states), provide direct menu access points, and more.



## Free USB Programming Software & Cable

The ProVu® comes preloaded with free **MeterView® Pro** programming software that connects and installs directly to your PC with a standard USB cable, also provided free with each instrument. This eliminates the need to insert CDs, install drivers, or download software from the internet. The software will allow you to configure, monitor, and datalog a ProVu® PD6100 using your PC. Just simply connect the meter to your PC with the USB cable and within minutes you will be programming it.

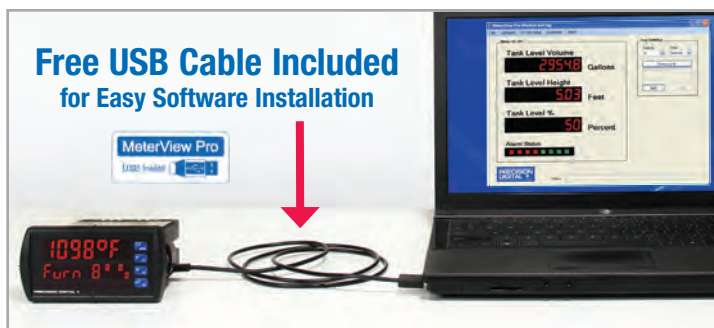

**Free USB Cable Included for Easy Software Installation**



## Configurable

The upper display can be programmed to indicate PV, maximum (peak), minimum (valley), alternating maximum/minimum, one of eight alarm set points, or Modbus input. The lower display can also be configured to display engineering units, set points, user defined legends, or simply turned off.

# PD6100 PROVU® Strain Gauge, Load Cell & mV Meter

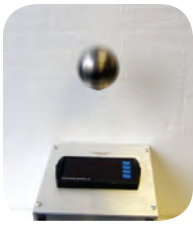

## Rugged

A unique front panel design makes the PROVU nearly impenetrable in typical applications. Here, the PROVU easily survives a direct hit on the display from a heavy 2" solid stainless steel ball dropped from a height of eight feet.

## On-Board Digital Input

The PD6100 includes a digital input as a standard feature. This digital input can operate with the tare, reset tare, or interlock relays feature, force relays on from a signal from a PLC or relay on other equipment, and much more. This is ideal for installations where the meter is inaccessible behind a cover, or where an additional function key is needed for customized operation.

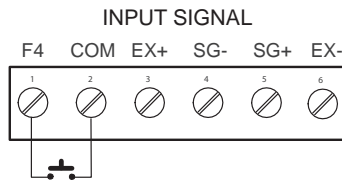

## Zero the Meter

The zero function zeroes out the display. In the case where there has been drift in the strain gauge output over time, zero is used to eliminate this drift and provide a true zero reading. For example, if an empty scale were to display a value other than zero, the zero function would tell the meter to show zero regardless of the current input signal.

## Capture Tare

The tare function also zeroes out the display. In the case of scale weight, tare is used to eliminate container weight and provide net weight readings. If the tare value is a known constant, such as a container weight, this may be programmed in manually. The captured tare may be reset manually with any function key or digital input.

## Automatic Unit Conversion

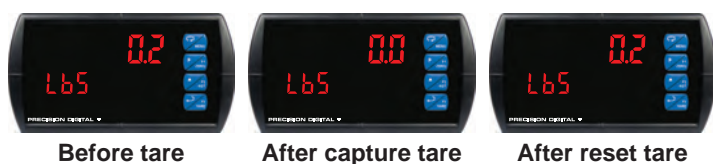

In addition to entering a custom unit or tag, pre-defined engineering units may be selected: lb, kg, ounce, gram, ton (short), tonne (metric ton). Automatic unit conversions are done when switching between pre-defined units, without the need for additional scaling. The meter converts the reading according to the unit selected (e.g. 100.00 lb = 45.36 kg = 45359.2 g = 1600 oz).

## Auto-Zero

The auto-zero feature corrects for drift that can occur over time that causes the input signal to slowly change. The meter will continue to read zero despite slow and small changes to the input signal around zero. The auto-zero sensitivity is set by the user as a percent of full scale.

## Rounding

The rounding feature is used to give the user a steadier display with fluctuating signals. It causes the display to round to the nearest value according to the rounding value selected (1, 2, 5, 10, 20, 50, or 100). For example, with a rounding value of 10, and an input of 12346, the display would indicate 12350.

## Shunt Calibration Check

The PD6100 is equipped with a means of simulating strain in a strain gauge bridge circuit, via an included shunt resistor in the meter. This technique can be used as a means of verifying the meter setup and output behavior by simulating a physical input. With no load connected, the enabling of the shunt resistor will simulate a 70% full scale load in the case of a 350Ω Strain Bridge.

## Ratiometric Compensation

This feature compensates for changes in the strain gauge input signal that are due to variations in the internal or external excitation voltage. The compensation is effective for up to ±5% variation in the excitation power supply.

## Dual-Scale Display Feature

The PROVU PD6100 has a rather unique, and very flexible dual-scale capability; a second scaled display can represent the measured input in a different form (i.e. gallons & height). This is of particular value in level applications. Please see the examples shown below. Both displays are independently scaled and are based on the 4-20 mA input signal. Beyond level, this function has been used for pressure & force, weight & piece count, feet & meters, and more.



Volume & Height



Pressure & mV

## Advanced Linearization Capability

The PROVU includes a 32-point linearizer. In non-linear level applications (i.e. some pumping or lift stations), it can easily compensate for submerged equipment or plumbing that displace usable volume. A second independent 8-point linearizer is available for a second scaled display (PV2) when the dual scale feature is enabled. Precision Digital's free MeterView Pro PC-based software greatly simplifies the construction of the linearization tables. The software can save this data to the meter and/or PC.

## FIELD EXPANSION MODULES

Add functionality to the PROVU in the field with easy-to-install external expansion modules. Add USB, RS-232, or RS-485 communications, I/O modules (up to 2), and 4-relay expansion module. The menu items for these modules do not appear until the module is connected, simplifying the basic menu. See ordering information for details.





# PD6100 PROVU® Strain Gauge, Load Cell & mV Meter

## APPLICATION

### Load Cell

A typical application for load cells is in a tank weighing operation. In the following example, this three-legged tank has a load cell under each leg. The three load cells are wired locally in parallel within a junction box. The combined signals are then connected to the PD6100. During field calibration, the weight of the empty tank (zero point) and the full tank weight (full scale) are programmed into the meter. Over time, the zero feature on the PD6100 can account for obstacles like sludge buildup on the bottom of the tank when empty.

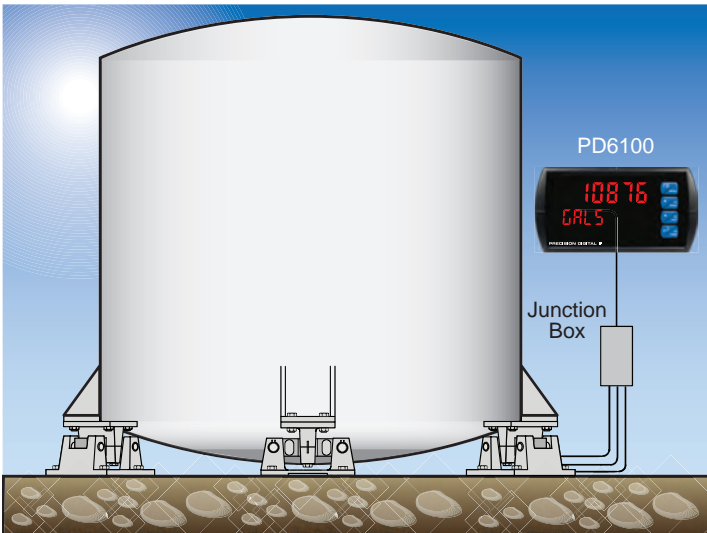

## DIGITAL COMMUNICATIONS

### Modbus® RTU Serial Communications

With the purchase of a serial communication adapter, PROVU meters can communicate with any Modbus Master device using the ever-popular Modbus communications protocol that is included in every PROVU. This greatly increases the flexibility of the meter. Modbus provides much more capability than read PV and write set points. Below are some examples of other things that can be done with PROVU's Modbus communications.

- Send a 6-character message to the lower display upon an event
- Convert a digital value to a 4-20 mA signal
- Remote user control (i.e. change set points, acknowledge alarms)
- Input a Modbus digital PV (in place of analog input)
- Remote override of any, or all, relays and analog outputs



Modbus PV Input



Remote Message

## METERVIEW® PRO SOFTWARE

## OUTPUTS

### Relay Outputs

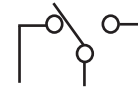

The PROVU has up to four 3 A Form C relays (SPDT) with multiple power loss fail-safe options. Relays can be configured for proper protective action upon input loop break. Relay ON and OFF delay times are user adjustable. Up to eight front panel indicators show alarm and/or relay state. All relays can be configured for 0-100% deadband.

### Relay Operation/Configuration

There are powerful relay functions that can be configured in the PROVU meter, including:

- Automatic reset only (non-latching)
- Automatic + manual reset at any time (non-latching)
- Latching (manual reset only)
- Latching with clear (manual reset only after alarm condition has cleared)
- Pump alternation control (automatic reset only)
- Sampling (activated for a user-specified time)
- User selectable fail-safe operation
- Relay action for loss (break) of 4-20 mA input signal
- Time delay (on and off), independent for each relay
- Manual control mode
- Interlock relay mode

### Analog Output

The isolated analog retransmission signal can be configured to represent the process variable (PV), maximum (peak) value, minimum (valley) value, the value for any of the eight relay set points, or Modbus input. While the output is nominally 4-20 mA, the signal will accurately accommodate under- and over-ranges from 1 to 23 mA.

### Manual Output Control

Take control of any output with this feature. All relays can be forced ON or OFF, and the 4-20 mA output signal can be set to any value within its range. When the relays and 4-20 mA output are controlled manually, an LED labeled "M" is turned on and the associated Alarm LEDs (1-8) flash every 10 seconds indicating that the meter is in manual control mode.

## CONNECTIONS

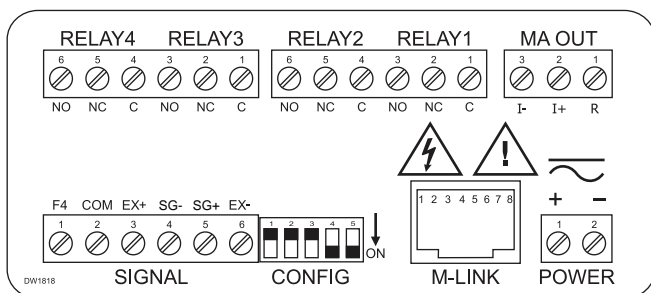

# PD6100 ProVu® Strain Gauge, Load Cell & mV Meter

## SPECIFICATIONS

Except where noted all specifications apply to operation at +25°C.

### General

**Display:** Upper display: 0.60" (15 mm) high. Lower display: 0.46" (12 mm) high. Both are 6 digits (-99999 to 999999), red LEDs.

**Display Intensity:** Eight intensity levels

**Display Update Rate:** 5/second (200 ms)

**Overrange:** Display flashes 999999

**Underrange:** Display flashes -99999

**Display Assignment:** The displays may be assigned to PV1, PV2, PCT, max & min, set points, PV & units, units (lower display only), net & gross weight, Modbus input, and display millivolts.

**Units:** lb, kg, ounce, gram, ton, metric ton (tonne), custom units.

**Front Panel:** NEMA 4X, IP65

**Programming Methods:** Four front panel buttons, digital inputs, PC and MeterView Pro software, Modbus registers, or cloning using Copy function.

**F4 Digital Input Contacts:** 3.3 VDC on contact. Connect normally open contacts across F4 to COM.

**F4 Digital Input Logic Levels:** Logic High: 3 to 5 VDC  
Logic Low: 0 to 1.25 VDC

**Noise filter:** Programmable from 2 to 199 (0 will disable filter)

**Filter Bypass:** Programmable from 0.1 to 99.9% of calibrated span

**Rounding:** Select 1, 2, 5, 10, 20, 50, or 100 (e.g. rounding = 10, value = 123.45, display = 123.50).

**Recalibration:** All ranges are calibrated at the factory. Recalibration is recommended at least every 12 months.

**Max/Min Display:** Max/min readings reached by the process are stored until reset by the user or until power to the meter is cycled.

**Password:** Three programmable passwords restrict modification of programmed settings.

**Non-Volatile Memory:** All programmed settings are stored in non-volatile memory for a minimum of ten years if power is lost.

**Power Options:** 85-265 VAC 50/60 Hz, 90-265 VDC, 20 W max, or optional model with 12-24 VDC  $\pm 10\%$ , 15 W max.

**Fuse:** Required external fuse: UL Recognized, 5 A max, slow blow; up to 6 meters may share one 5 A fuse.

**Isolated Sensor Power Supply:**  
Terminals Ex+ & Ex-: 10 VDC or 5 VDC  $\pm 10\%$ . Rated @ 350 mA max.  
*Note: Do not use 24 VDC to power strain gauge bridge*

**Normal Mode Rejection:** Greater than 60 dB at 50/60 Hz

**Isolation:** 4 kV input/output-to-power line. 500 V input-to-output (powered by external supply).

**Overvoltage Category:** Installation Overvoltage Category II: Local level with smaller transient overvoltages than Installation Overvoltage Category III.

**Environmental:** Operating temperature range: -40 to 65°C  
Storage temperature range: -40 to 85°C  
Relative humidity: 0 to 90% non-condensing

**Connections:** Removable screw terminal blocks accept 12 to 22 AWG wire, RJ45 for external relays, digital I/O, and serial communication adapters.

**Enclosure:** 1/8 DIN, high impact plastic, UL 94V-0, color: black

**Mounting:** 1/8 DIN panel cutout required: 3.622" x 1.772" (92 mm x 45 mm). Two panel mounting bracket assemblies are provided.

**Tightening Torque:** Screw terminal connectors: 5 lb-in (0.56 Nm)

**Dimensions:** 4.68" x 2.45" x 5.64" (119 mm x 62 mm x 143 mm) (W x H x D)

**Weight:** 9.5 oz (269 g)

**UL File Number:** UL & c-UL Listed. E160849; 508 Industrial Control Equipment.

**Warranty:** 3 years parts & labor

**USB Connection:** Compatibility: USB 2.0 Standard, Compliant  
Connector Type: Micro-B receptacle  
Cable: USB A Male to Micro-B Cable  
Driver: Windows 98/SE, ME, 2000, Server 2003/2008, XP 32/64-Bit, Vista 32/64-Bit, Windows 7 32/64-Bit, Windows 10 32/64-Bit  
Power: USB Port

### Strain Gauge Input

**Inputs:** Field selectable: 0-15, 0-30, 0-150, 0-300 mV,  $\pm 15$ ,  $\pm 25$ ,  $\pm 150$ ,  $\pm 250$  mV, or Modbus PV (Slave)

**Accuracy:**  $\pm 0.03\%$  of calibrated span  $\pm 1$  count

**Minimum Load Resistance:** 28  $\Omega$  10 V, 14  $\Omega$  @ 5 V

**Maximum Excitation Current:** 350 mA @ 5 V or 10 V

**Temperature Drift:** 0.002% of calibrated span/ $^{\circ}$ C max from 0 to 65 $^{\circ}$ C ambient, 0.005% of calibrated span/ $^{\circ}$ C max from -30 to 0 $^{\circ}$ C ambient

**Function:** Linear with multi-point linearization

**Low-Flow Cutoff:** 0-999999 (0 disables cutoff function)

**Decimal Point:** Up to five decimal places or none: *d.ddddd*, *dd.ddddd*, *ddd.dddd*, *dddd.dd*, *ddddd.d*, or *dddddd*.

**Calibration Range:**

Input Range	Minimum Span Input 1 & Input 2
15 mV	0.2 mV
25 mV, 30 mV	0.4 mV
150 mV	2.0 mV
250 mV, 300 mV	4.0 mV

*An Error message will appear if the input 1 and input 2 signals are too close together.*

**Input Impedance:** Strain Gauge Bridge: Greater than 10 M $\Omega$   
mV Source: 200 k $\Omega$

### Relays

**Rating:** 2 or 4 SPDT (Form C) internal and/or 4 SPST (Form A) external; rated 3 A @ 30 VDC and 125/250 VAC resistive load; 1/14 HP ( $\approx$  50 watts) @ 125/250 VAC for inductive loads.

**Noise Suppression:** Noise suppression is recommended for each relay contact switching inductive loads.

**Deadband:** 0-100% of span, user programmable

**High or Low Alarm:** User may program any alarm for high or low trip point. Unused alarm LEDs and relays may be disabled (turned off).

**Relay Operation:** automatic (non-latching), latching (requires manual acknowledge), sampling (based on time), pump alternation control (2 to 8 relays), Off (disable unused relays and enable interlock feature, manual on/off control mode).

**Relay Reset:** User selectable via front panel buttons or digital inputs.

1. Automatic reset only (non-latching), when input passes the reset point.
2. Automatic + manual reset at any time (non-latching).
3. Manual reset only, at any time (latching).
4. Manual reset only after alarm condition has cleared (latching).

*Note: Front panel button or digital input may be assigned to acknowledge relays programmed for manual reset.*

**Time Delay:** 0 to 999.9 seconds, on & off relay time delays. Programmable and independent for each relay.

**Fail-Safe Operation:** Programmable and independent for each relay.

*Note: Relay coil is energized in non-alarm condition. In case of power failure, relay will go to alarm state.*

**Auto Initialization:** When power is applied to the meter, relays will reflect the state of the input to the meter.

### Serial Communications

**Protocol:** Modbus® RTU

**Slave ID:** 1 - 247 (Meter address)

**Baud Rate:** 300 - 19,200 bps

**Transmit Time Delay:** Programmable between 0 and 199 ms or transmitter always on for RS-422 communication

**Data:** 8 bit (1 start bit, 1 or 2 stop bits)

**Parity:** Even, odd, or none with 1 or 2 stop bits

**Byte-to-Byte Timeout:** 0.01 - 2.54 seconds

**Turn Around Delay:** Less than 2 ms (fixed)

# PD6100 ProVu® Strain Gauge, Load Cell & mV Meter

## Isolated 4-20 mA Transmitter Output

**Output Source:** Process variable (PV), max, min, set points 1-8, manual control setting, or Modbus input

**Scaling Range:** 1.000 to 23.000 mA for any display range

**Calibration:** Factory calibrated: 0.00 to 100.0 = 4-20 mA output

**Analog Output Programming:** 1.000 mA minimum and 23.000 mA maximum for all parameters: Overrange, underrange, max, min, and break

**Accuracy:** ± 0.1% of span ± 0.004 mA

**Temperature Drift:** 0.4 µA/°C max from 0 to 65°C ambient,

0.8 µA/°C max from -40 to 0°C ambient

*Note: Analog output drift is separate from input drift.*

**Isolated Transmitter Power Supply:** Terminals I+ & R: 24 VDC ± 10%. Isolated from the input at >500 V. May be used to power the 4-20 mA output or other devices (except load cell/strain gauge). All models rated @ 40 mA max.

**External Loop Power Supply:** 35 VDC maximum

**Output Loop Resistance:**

Power supply	Minimum	Maximum
24 VDC	10 Ω	700 Ω
35 VDC (external)	100 Ω	1200 Ω

## Digital I/O Expansion Module

**Channels:** 4 digital inputs & 4 digital outputs per module

**System:** Up to 2 modules for a total of 8 inputs & 8 outputs

**Digital Input Logic:** High: 3 to 5 VDC Low: 0 to 1.25 VDC

**Digital Output Logic:** High: 3.1 to 3.3 VDC Low: 0 to 0.4 VDC

**Source Current:** 10 mA maximum

**Sink Current:** 1.5 mA minimum

**+5 V Terminal:** To be used as pull-up for digital inputs only.

## 4-Relay Expansion Module

**Relays:** Four Form A (SPST) rated 3 A @ 30 VDC and 125/250 VAC resistive load; 1/14 HP (≈ 50 watts) @ 125/250 VAC for inductive loads.

## DIMENSIONS

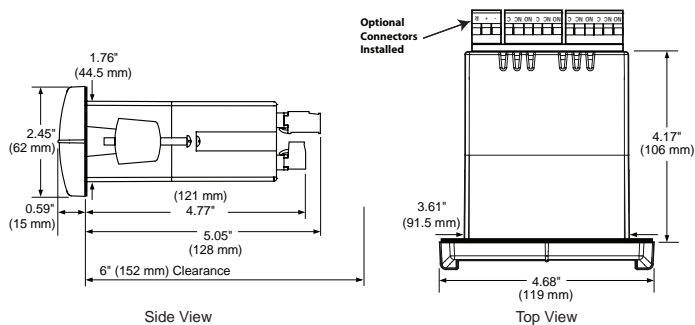

Notes:

1. Panel cutout required: 1.772" x 3.622" (45 mm x 92 mm)
2. Panel thickness: 0.040 - 0.250" (1.0 mm - 6.4 mm)
3. Mounting brackets lock in place for easy mounting
4. Clearance: Allow 6" (152 mm) behind the panel

## ORDERING INFORMATION

ProVu® PD6100 • Standard Models		
85-265 VAC Model	12-24 VDC Model	Options Installed
PD6100-6R0	PD6100-7R0	None
PD6100-6R2	PD6100-7R2	2 Relays
PD6100-6R3	PD6100-7R3	4-20 mA Output
PD6100-6R4	PD6100-7R4	4 Relays
PD6100-6R5	PD6100-7R5	2 Relays & 4-20 mA Output
PD6100-6R7	PD6100-7R7	4 Relays & 4-20 mA Output

ProVu® PD6100 • SunBright Display Models		
85-265 VAC Model	12-24 VDC Model	Options Installed
PD6100-6H0	PD6100-7H0	None
PD6100-6H2	PD6100-7H2	2 Relays
PD6100-6H3	PD6100-7H3	4-20 mA Output
PD6100-6H4	PD6100-7H4	4 Relays
PD6100-6H5	PD6100-7H5	2 Relays & 4-20 mA Output
PD6100-6H7	PD6100-7H7	4 Relays & 4-20 mA Output

Accessories	
Model	Description
PDA1002	DIN Rail Mounting Kit for Two Expansion Modules
PDA1004	4-Relay Expansion Module
PDA1044	4 Digital Inputs & 4 Digital Outputs Module
PDA1232	RS-232 Serial Adapter
PDA1485	RS-422/485 Serial Adapter
PDA7485-I	RS-232 to RS-422/485 Isolated Converter
PDA7485-N	RS-232 to RS-422/485 Non-Isolated Converter
PDA8232-N	USB to RS-232 Non-Isolated Converter
PDA8485-I	USB to RS-422/485 Isolated Converter
PDA8485-N	USB to RS-422/485 Non-Isolated Converter
PDX6901	Suppressor (snubber): 0.01 µF/470 Ω, 250 VAC

Your Local Distributor is:

### Disclaimer

The information contained in this document is subject to change without notice. Precision Digital Corporation makes no representations or warranties with respect to the contents hereof, and specifically disclaims any implied warranties of merchantability or fitness for a particular purpose.

©2014-2016 Precision Digital Corporation. All rights reserved.

LDS6100\_E 04/16

