

Earth Resistance and Resistivity Tester

Model GRT350

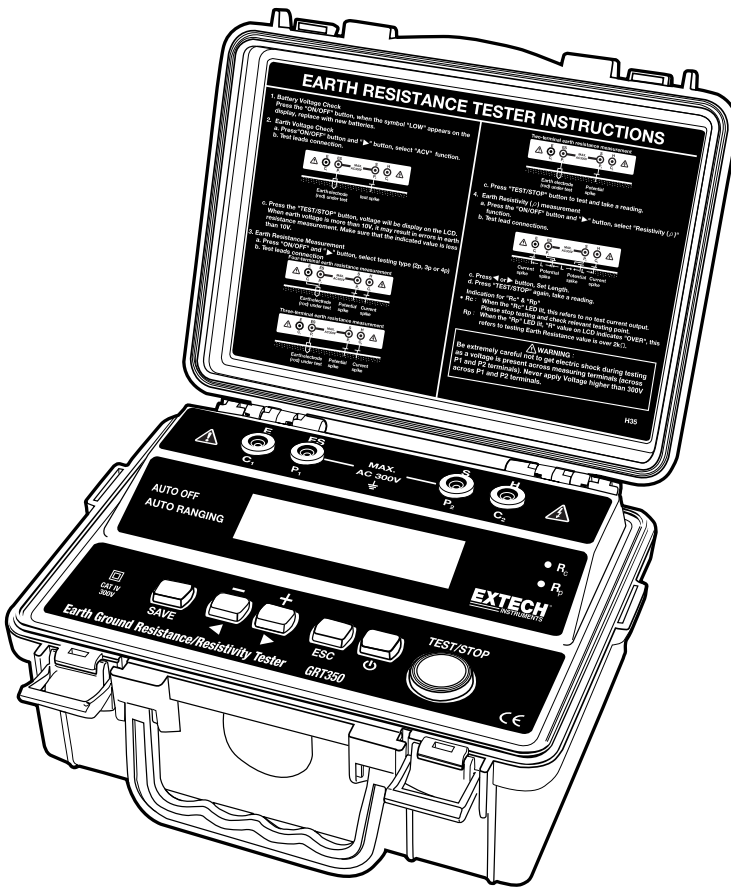

Additional User Manual Translations available at www.extech.com

Introduction

Thank you for selecting the Extech Instruments Model GRT350 Earth Resistance and Resistivity Tester. The GRT350 has been designed and tested according to the IEC Publication 348, safety requirements for Electronic Measuring Apparatus, EN 61010-1, EN 61326-1, EN 61557-1, EN 61557-5 and other safety standards. This device is shipped fully tested and calibrated and, with proper use, will provide years of reliable service. Please visit our website (www.extech.com) to check for the latest version of this User Guide, Product Updates, Product Registration, and Customer Support.

Features

- Microprocessor controlled with advanced safety features
- Two line LCD display
- Auto-Ranging
- Earth resistance testing with three ranges: 0-20 Ω /0-200 Ω /0-2k Ω
- Earth voltage measuring range of 0-300Vac
- Automatic C (current) spike check.
- Automatic P (potential) spike check.
- 2-wire test
- 3-wire test
- 4-wire test
- Earth Resistivity (Wenner – 4 terminal)
- Auto power off
- Low battery indicator
- Data hold
- 200 memory locations to save test data
- Safety standard: EN 61010-1 CATIV 300V, EN 61326-1

Safety Information

- Read the all safety information carefully before attempting to operate the meter.
- Use the meter only as specified in this manual. Otherwise, the protection provided by the meter may be impaired.
- Rated environmental conditions:
 - Indoor & outdoor use
 - Installation Category IV 300V
 - Pollution Degree 2
 - Altitude up to 2000m
 - Relative Humidity 80% maximum
 - Ambient temperature 0-40°C

Observe the International Electrical Symbols listed below:



Double insulation



This symbol, adjacent to a terminal, indicates that, under normal use, hazardous voltages may be present



This symbol, adjacent to another symbol or terminal, indicates the user must refer to the manual for further information.



Earth (ground) terminal



Equipment complies with current EU directives

WARNING

To avoid electrical shock, do not touch the terminals during tests
Never apply Voltage higher than 300V across P1 and P2 terminals

Meter Description

1. C1 terminal (Black test lead connection)
2. P1 terminal (Green test lead connection)
3. P2 terminal (Yellow test lead connection)
4. C2 terminal (Red test lead connection)
5. Display
6. Rc LED
7. Rp LED
8. Save button
9. Cursor buttons
10. Cursor buttons
11. ESC button
12. Power button
13. TEST/STOP button

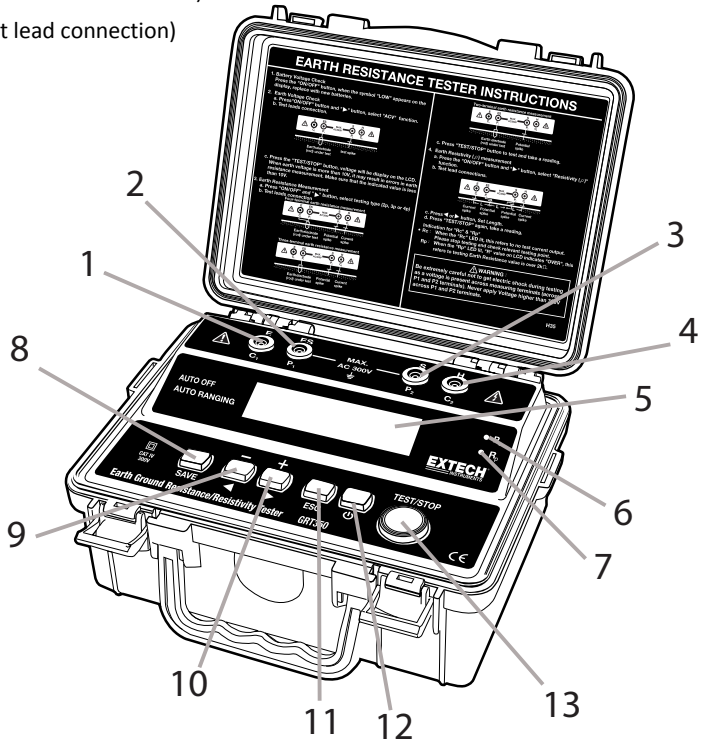

Operation

Battery Voltage check

Press the "ON/OFF" button, if "Battery Low" appears on the display, replace the batteries.

Earth Voltage measurement

1. Connect the test leads as shown below.

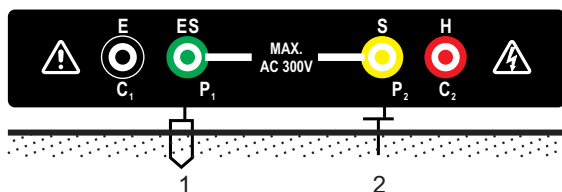

- (1) Earth electrode (rod) under test (2) Test spike

2. Press the "ON/OFF" button and wait for "Select Function" to appear on the display.
3. Press the "▶" button 3 times and wait for "ACV" to appear on the display.
4. Press the "TEST/STOP" button.
5. The earth voltage will appear on the display if it is present.
6. Press SAVE to save the measurement in Log memory.
7. Press ESC to return to the "Select Function" display.

Measurement Considerations

Two-terminal testing of earth resistance is appropriate for most general purpose testing in normally conductive soil. However, two-terminal measurements include test lead and contact resistance in the measurement and the result will be a reading slightly higher than the true earth resistance.

When measured results are higher than desired or if measurement directives require multi-terminal techniques, switch to the 3 or 4 terminal techniques as needed.

Earth Resistance measurement

Note: The measured results may be influenced by inductive or capacitive coupling if the test leads are twisted or adjacent to each other.

When connecting the Probes, keep the leads separated.

Setup

Insert the Potential electrodes (P) and the Current electrodes (C) as deep as possible into the soil. The distance between electrodes must be be 5 to 10m (16 to 32').

Four-terminal earth resistance measurements

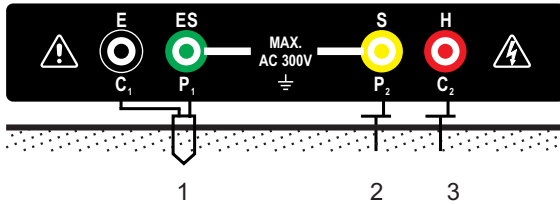

(1) Earth electrode (rod) under test (2) Potential spike (3) Current spike

Three-terminal earth resistance measurements

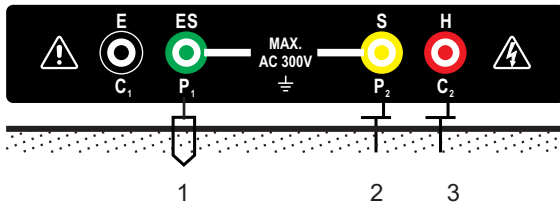

(1) Earth electrode (rod) under test (2) Potential spike (3) Current spike

Two-terminal earth resistance measurements

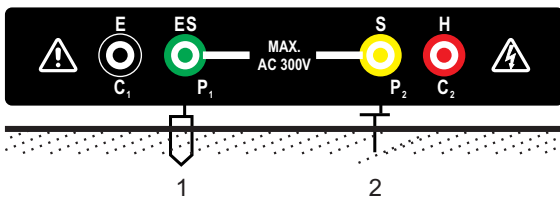

(1) Earth electrode (rod) under test (2) Potential spike

Testing

1. Connect the test leads for 2, 3 or 4 terminal Earth Resistance testing.
P1 = Green lead, C1 = Black lead, P2 = Yellow lead, C2 = Red lead
2. Press the ON/OFF button and wait for the "Select Function" screen to appear.
8. Press the "▶" button to select "2P", "3P" or "4P" depending on the test.
3. Press "TEST/STOP" button to begin the test.
4. The meter will beep while the test is in progress (for approximately 10 seconds) and then the reading will appear on the lower line of the display.
5. Press SAVE to save the results in Log memory.
6. Press ESC to return to the "Select Function" display.

Notes for "Rc" & "Rp" LED indications:

Rc: No test current output. Check the connections and settings.

Rp: If Rp is on and the display indicates "> 2 kΩ", the earth resistance is greater than 2000Ω.

Earth Resistivity Testing (ρ) (Wenner 4-point method)

Insert the four electrodes at equal distances (and in a straight line) at an interval of 1 to 30m (3.3 to 32.3') apart. The depth should be 5% (or less) the distance between the electrodes.

For example: if the distance between the electrodes is 5m (16'), the electrodes should be inserted to a depth of 25cm (10"). (500cm x 5% = 25cm)

NOTE: The length can be set between 1 and 50m (3.3' and 164').

1. Connect the test leads for 4 terminal testing.
7. Press the ON/OFF button and wait for the "Select Function" screen to appear.
2. Press the "▶" button and select "Resistivity".
3. Press "TEST/STOP" button. The setting length will display on the screen.
4. Press the "▶" or "◀" arrow buttons to set the count up or down.
5. Press "TEST/STOP" button to begin the test.
6. Press SAVE to save the results in Log memory.
7. Press ESC to return to the "Select Function" display.

Save Function

The meter permits saving measurements in up to 200 memory locations. When a test has completed, press the SAVE button to store the measured data.

The display will show the location number of the saved data. "SAVE ###"

LOG Display

1. Press the ON/OFF button and wait for the "Select Function" screen to appear.
2. Press the "▶" button and select "LOG Display".
3. Press the "TEST/STOP" button. The log number will display on the screen.
4. Press the "▶" or "◀" arrow button to scroll through the saved data.
5. Press ESC to get back to the "Select Function" display.

LOG Clear

1. Press the ON/OFF button and wait for the "Select Function" screen to appear.
2. Press the "▶" button and select "LOG Clear"
3. Press the "TEST/STOP" button. "Are you sure?" will display on the screen.
4. Press the "TEST/STOP" button to clear the log data. "Successful!" will display on the screen.
5. Press the "TEST/STOP" button to verify that the data log is clear. "No Log data" will display on the screen.
6. Press ESC to get back to the "Select Function" display.

Maintenance

1. Rear cover
2. Battery compartment
3. Fuse

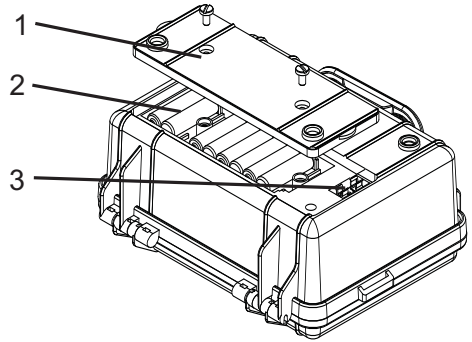

Fuse Replacement

1. Disconnect the test leads from the instrument.
2. Remove the rear cover by removing the two screws.
3. Remove and replace the fuse with a new one of the same value and size 0.5A/500V, (5 x 20mm).
4. Replace and secure the rear cover.

Battery replacement

When “Battery Low” appears on the display, replace the batteries.

1. Disconnect the test leads from the instrument and remove the rear cover and the batteries.
2. Replace with eight 1.5V AA batteries, taking care to observe correct polarity.
3. Reinstall battery holder and battery cover.



Never dispose of used batteries or rechargeable batteries in household waste.

As consumers, users are legally required to take used batteries to appropriate collection sites, the retail store where the batteries were purchased, or wherever batteries are sold.

Disposal: Do not dispose of this instrument in household waste. The user is obligated to take end-of-life devices to a designated collection point for the disposal of electrical and electronic equipment.

Cleaning

WARNING: To avoid electrical shock or damage to the meter, do not allow water inside the case.

Periodically wipe the case with a damp cloth and detergent, do not use abrasives or solvents.

Specifications

Earth Resistance Ranges	Ranges: 0-20 Ω , 0-200 Ω , 0-2k Ω Accuracy: $\pm(2\%rdg+3dgt)$
Earth Resistance Resolution	0-20 Ω : 0.01 Ω 0-200 Ω : 0.1 Ω 0-2k Ω : 1 Ω
Earth Voltage	Range: 0-300VAC (50/60 Hz) Accuracy: $\pm(2\%rdg+3dgt)$
Earth Resistivity Ranges (ρ) ($\rho = 2 \pi LR$) L = distance between probes R = resistance	0.06-6.28 k Ω .m 0.62-62.8 k Ω .m 6.28-628 k Ω .m
Test Frequency	820Hz
Test Current	2mA
Data Memory	200 manual locations
Test lead lengths	Green lead 5 m (16 ft) Black lead 10m (32 ft) Yellow lead 10m (32ft) Red lead 15m (49ft)
Temperature & Humidity	Operating: 0 to 50°C (32 to 122°F); $\leq 80\%R.H.$ Storage: -10 to 60°C (14 to 140°F); $\leq 80\%R.H.$
Altitude	2000m (6500') max
Power Source	1.5V(AA) x 8 batteries
Dimensions	250(L) x 190(W) x 110(D)mm (9.84 x 7.5 x 4.33")
Weight	Approx. 1430g (batteries installed)
Fuse	500mA/500V (5 x 20mm) fast blow, ceramic type
Safety Standards	CAT IV-300V, EN 61010-1, EN 61326-1, EN 61557-1, EN 61557-5

Copyright © 2014-2016 FLIR Systems, Inc.

All rights reserved including the right of reproduction in whole or in part in any form
ISO-9001 Certified

www.extech.com