

## BATTERY HiTESTER BT3563/BT3562/3561

Component measuring instruments



**Simultaneous high-speed measurement of internal resistance and battery voltage**

## **From large-cell to high-voltage battery testing - HIOKI is The Choice**

The BT3563, BT3562, and 3561 BATTERY HiTESTERs support simultaneous high-speed measurement of internal resistance (IR) and battery voltage (OCV) for the ever-expanding production lines of increasingly larger lithium-ion low resistance batteries, and other battery packs for high voltage applications.

- Measure high-voltage battery packs up to 300V (with the BT3563)
- Ideal for high-precision cell voltage measurements (accurate to 0.01% of reading)
- Measurement circuitry employs enhanced current regulation
- Fast 10 ms response and 8 ms sampling time for high-speed measurements (with the BT3563 and BT3562)
- Ranges from 3 mΩ to 3000 Ω (with the BT3563 and BT3562) support coin-size to large-cell batteries



# Resistance and voltage measurements

## BATTERY HiTESTER BT3563 BT3562 3561



### ■ Measurement Parameters and Applications

- High-voltage battery pack testing
- Battery module testing
- Large (low-resistance) cell testing
- High-speed mass production testing of coin batteries
- Fuel cell stack measurements
- Battery research and development measurement applications

**BT3563**  
Up to  
**300V**

**BT3562**  
Up to  
**60V**



**Voltage measurement ranges:** 6V/60V/300V (BT3563)  
6V/60V (BT3562)

**Resistance measurement ranges:** 3mΩ/30mΩ/300mΩ/  
3Ω/30Ω/300Ω/3000Ω

### Lithium-Ion and Secondary Batteries



Cell phones



E-books



Electric bicycles



Electric scooters



EV/HEV

### Battery-Powered Devices

### ■ Advanced Functions

#### ● Four-Terminal AC Method

The four-terminal, 1-kHz AC method uses four contact probes to measure resistance independently of that of the measurement leads.

#### ● Measurement Error Detection

Detects test probe contact failure and broken leads for 100%

#### ● Self-Calibrating

Minor drift and gain fluctuations within the internal measurement circuitry are automatically corrected to maintain high accuracy.

#### ● Averaging Function

Stable readings can be consistently obtained by averaging two to

# to confirm finished quality

## ■ Features of Battery HiTester Series

### High Precision

**Resistance**  
 $\pm 0.5\%$  rdg.  $\pm 5$  dgt.  
**Voltage**  
 $\pm 0.01\%$  rdg.  $\pm 3$  dgt.

Common to the BT3563, BT3562 and 3561

### High Resolution

**Resistance:  $0.1 \mu\Omega$ <sup>\*1</sup>**  
**(3 m $\Omega$  range)**  
**Voltage:  $10 \mu V$ <sup>\*1</sup>**  
**(6 V range)**

<sup>\*1</sup> BT3563 and BT3562

### Quick Response

**Resistance & Voltage**  
**Simultaneous measurements**  
**within 18 ms<sup>\*2</sup>**

<sup>\*2</sup> Sampling time + response time:  
 with EX.FAST sampling  
 BT3563 and BT3562

- The 3 m $\Omega$  range (with  $0.1 \mu\Omega$  resolution) is ideal for testing ever lower-resistance large cells (BT3563 and BT3562).
- The 6 V range (with  $10 \mu V$  resolution and 0.01% accuracy) is ideal for the high-precision voltage measurements required for cell testing (BT3563 and BT3562).

- Provides high-speed measurement of high-voltage<sup>\*3</sup> battery packs, for improving productivity (BT3563).

<sup>\*3</sup> BT3563: up to 300V  
 BT3562: up to 60V

## ■ Measurement Parameters and Applications

## BATTERY HiTESTER 3561

- For high-speed production line testing of small battery packs for mobile and portable communications devices
- For high-speed production line testing of small cells
- *High-speed 10ms inspection in the 300m $\Omega$  and 3 $\Omega$  ranges*
- *Improve inspection efficiency during mass production of compact cells*

3561  
 Up to  
**20V**



**Voltage measurement ranges: 20V**

**Resistance measurement ranges: 300m $\Omega$ /3 $\Omega$**

### Lithium-Ion and Secondary Batteries

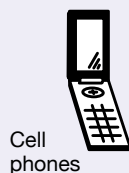

### Battery-Powered Devices

**Quick Response**  
 with small cell measurement

**Resistance & Voltage**  
**Simultaneous measurements**  
**within 10 ms<sup>\*4</sup>**

<sup>\*4</sup> Sampling time + response time:  
 with EX.FAST sampling  
 3561

## Battery HiTester Series

- **Measurement Value Storage**  
 Store up to 400 measurement values by external trigger input, for bulk transfer to a computer.
- **Statistical Calculations**  
 Apply statistical calculations to up to 30,000 data points to facilitate process and quality control.

- **Save Measurement Setting Configurations**  
 Up to 126 measurement configurations such as comparator setting criteria can be saved and reloaded. Saved configurations can be selected by external control.

# Automatic Testing Lines

## High Speed Interfaces

The fastest 10 ms measurement data can be transferred via the standard RS-232C interface at up to 38,400 bps. Models with the -01 suffix include a GP-IB interface.

## Handler Interface

Triggering, measurement configuration loading, and zero adjustment can be externally controlled. Output signals provide comparator results, end-of-measurement events, and measurement errors. (Because the BT3563/BT3562 are different from the 3561, consult each model's Instruction Manual for specific details or designs.)

BT3563, BT3562 and 3561 External I/O Items	
Input (no-voltage contacts <sup>1)</sup> )	Output (open collector <sup>1)</sup> )
<ul style="list-style-type: none"> <li>Measurement trigger (<math>\overline{\text{TRIG}}</math>)</li> <li>Print (<math>\overline{\text{PRINT}}</math>)</li> <li>Zero adjustment (<math>\overline{\text{OAdj}}</math>)</li> <li>Calibrate (<math>\overline{\text{CAL}}</math>)</li> <li>Manual comparator (<math>\overline{\text{MANU}}</math>)</li> <li>Load panel settings (7 bits) (<math>\overline{\text{LOAD0}}</math> to <math>\overline{\text{LOAD6}}</math>)</li> </ul>	<ul style="list-style-type: none"> <li>End-of-Measurement (<math>\overline{\text{EOM}}</math>)</li> <li>Measurement-in-progress (<math>\overline{\text{INDEX}}</math>)</li> <li>Comparator results (<math>\overline{\text{R-Hi}}</math>, <math>\overline{\text{R-IN}}</math>, <math>\overline{\text{R-Lo}}</math>, <math>\overline{\text{V-Hi}}</math>, <math>\overline{\text{V-IN}}</math>, <math>\overline{\text{V-Lo}}</math>, <math>\overline{\text{PASS}}</math>, <math>\overline{\text{FAIL}}</math><sup>2</sup>)</li> <li>Measurement error (<math>\overline{\text{ERR}}</math>)</li> <li>General-purpose output (<math>\overline{\text{OUT1}}</math> to <math>\overline{\text{OUT9}}</math>) (only 3561)</li> </ul>

<sup>1</sup> The input and output signals of the BT3563 and BT3562 are isolated via photocouplers.

### EXT I/O Connectors (BT3563 and BT3562, accessories not supplied)

Installed connector (HiTester side): 37-pin D-SUB accepts #4-40 screws  
 Mating connectors: DC-37P-ULR (solder type) or DCSP-JB37PR (welded type) from Japan Aviation Electronics Industry, Ltd., or equivalent

### EXT I/O Connectors (3561, accessories not supplied)

Installed connector (HiTester side): 57RE-40360-730B (D29) (DDK)  
 Mating connectors: 57-30360 (DDK), RC30-36P (Hirose Electric Co., Ltd.), or equivalent

BT3563-01 and BT3562-01 Rear Panel

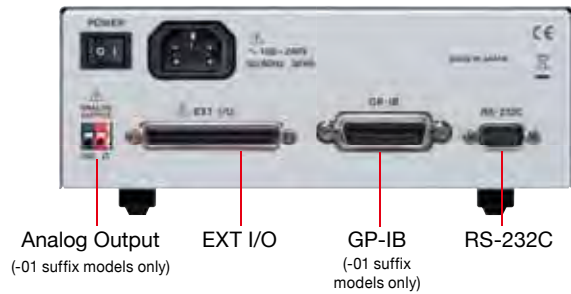

3561-01 Rear Panel

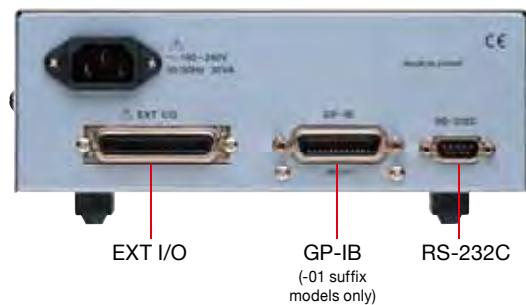

### BT3563 and BT3562 External I/O Timing Chart

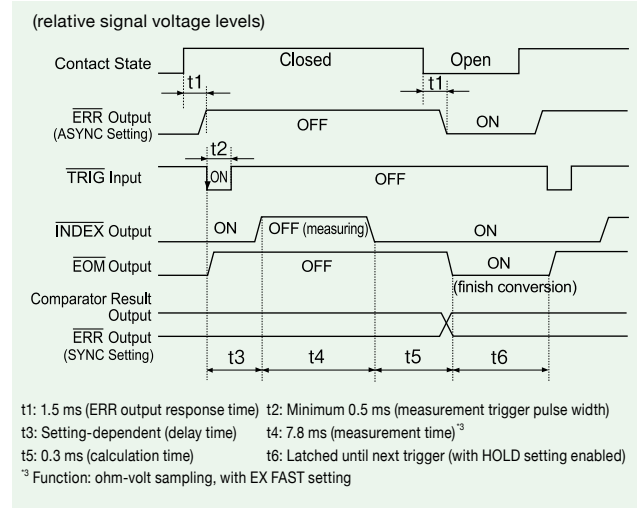

## Comparator Functions

### Judges Resistance & Voltage Simultaneously

Resistance and voltage can be simultaneously judged Hi/IN/Lo by independent comparators. Judgment results are provided on the display, beeper, and external I/O. The display allows confirming both results at a glance.



Resistance comparator settings



### Composite Judgment Result Output

External I/O provides both separate and combined outputs of resistance and voltage judgment results, so composite results can be monitored.

### Alternative Setting Methods

Set judgment thresholds by specifying high/low (Hi/Lo) values or by specifying a standard value and deviation (%).

### Manual Comparator

Comparator judgments can be executed only when required, supporting flexible control by footswitch or PLC.

### Dual Beep Tones

Different beep tones distinguish IN and Hi/Lo judgments. Both tones can be independently enabled or disabled.

# Multiple Recording Methods

## ■ Analog Output (BT3563-01 and BT3562-01 only)

The BT3563-01 and BT3562-01 provide analog output of resistance measurement values. This is convenient for combining recorded data from multiple locations or of various data types, such as for logging long-term measurements and for fuel cell evaluation.

Output contents	Measured resistance (displayed value)
Output rate	0 to 3.1 V DC (corresponding to displayed value of 0 to 31000)
Resolution	12 bits
Response time	10 ms



## ■ PC Application Program

Measurement data can be transferred to a PC for importing to a spreadsheet program or storage as CSV files. Interval and manual measurements can be triggered by a keystroke or external trigger signal.

Download the PC application program from our website:

<http://www.hioki.com/>

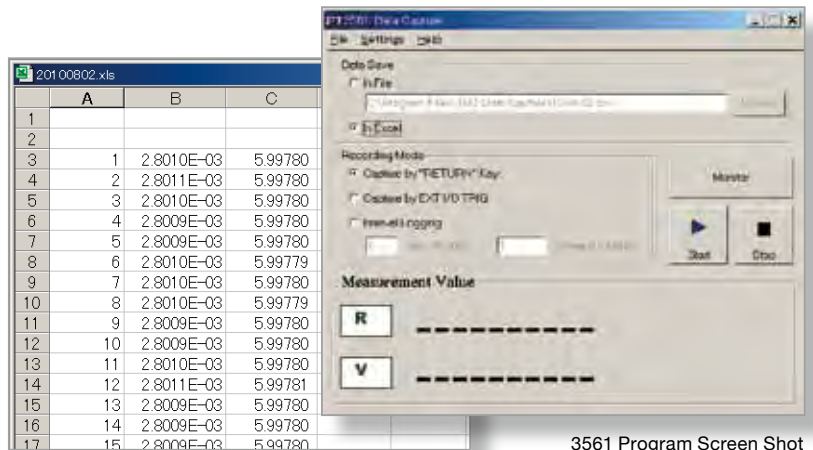

Excel Import Example

3561 Program Screen Shot

## ■ Data Printing

Measurement values, and those including judgment results and statistical calculation results can be printed using an RS-232C-compatible printer.

### ● Interval Printing

Elapsed time and measurement values can be printed over a specified interval. The interval can be set from 1 to 3,600 seconds.

### ● Requirement specification (printer)

The requirements for a printer to be connected to the instrument are as follows. Confirm compatibility and make the appropriate settings on the printer before connecting it to the instrument.

Interface	: RS-232C
Characters per line	: At least 40
Communication speed	: 9600 bps
Data bits	: 8
Parity	: none
Stop bits	: 1
Flow control	: none

BT3563/BT3562/3561 (9-pin) Connector

Function	Signal name	Pin
Receive Data	R x D	2
Transmit Data	T x D	3
Signal or Common Ground	GND	5

ASCII data will be sent from the BT3563/BT3562/3561. Please use a printer that can output plain text

## Printout Examples

```

1 2.5375mOhm, 4.70056 V
2 - 0.9730mOhm, 4.70055 V
3 0.F. , 0.F.
4 -----
5 15.039 Ohm, - 50.254 V
6 200.12 Ohm, 11.3176 V
7 2.9984kOhm, -11.3099 V
8 0.1615 Ohm, -4.70054 V
9 0.166 Ohm, - 4.7006 V
10 0.16 Ohm, - 4.700 V
    
```

Measurement Values

```

50 5.033 Ohm Hi, 1.60427 V
51 5.033 Ohm Hi, -0.00001 V
52 17.655mOhm IN
53 18.354mOhm Hi
54 15.322mOhm Lo
    
```

Measurement Values and Judgment Results

```

*** RESISTANCE ***
Number      85
Valid       85
Average     13.06 Ohm
Max         13.78 mOhm ( 74)
Min         12.10 mOhm ( 3)
Sn          0.38mOhm
Sn-1        0.38mOhm
Op          1.32
OpK         0.09
Comp Hi     40
Comp IN     45
Comp Lo     0

*** VOLTAGE ***
Number      85
Valid       85
Average     10.0074 V
Max         10.0197 V ( 57)
Min         9.9938 V ( 31)
Sn          0.0068 V
Sn-1        0.0068 V
Op          0.35
OpK         0.32
Comp Hi     10
Comp IN     59
Comp Lo     16
    
```

Statistical Calculations and Judgment Results

## ■ Specifications

### ● BT3563, BT3562 and 3561 Specifications

Measurement types	Resistance and voltage
Resistance measurement method	Four-terminal AC (1-kHz) method
Functions	ΩV, Ω and V
Rated voltage	[BT3563(-01)] ±300V DC rated input voltage ±300V DC maximum rated voltage to ground [BT3562(-01)] ±60V DC rated input voltage ±70V DC maximum rated voltage to ground [3561(-01)] ±22V DC rated input voltage ±70V DC maximum rated voltage to ground
Input resistance	[BT3563(-01) and BT3562(-01)] 3mΩ/30mΩ/300mΩ ranges: Approx. 90kΩ 3Ω/30Ω/300Ω/3000Ω ranges: Approx. 1MΩ [3561(-01)] Approx. 1MΩ
Sampling rate	Four steps – Extra Fast, Fast, Medium or Slow
Response time	[BT3563(-01) and BT3562(-01)] Approx. 10 ms for measurements Note: Response time depends on reference values and the measurement object. [3561(-01)] Approx. 3 ms for measurements Note: Response time depends on reference values and the measurement object.
Total measurement time	Sampling time + Response time

Zero-adjustment	1000-count range (both resistance and voltage)
Triggering	Internal or external
Delay time	On/off, 0 to 9.999 seconds
Averaging samples	On/off, 2 to 16 samples
Statistical calculations	Total data count; valid data count; maximum, minimum and average values; standard deviation; population standard deviation and process capability indices
Measurement value output function	Measurement values are output via RS-232C upon trigger input
Measurement value memory	Up to 400 measurements
Panel save/load	Up to 126 configuration settings Save Frequently Used Settings in Memory: Measurement function, resistance measurement range, auto-range setting, zero-adjust setting data, sampling rate, trigger source, delay setting, averaging and comparator settings, statistical calculation setting, display switching and key-lock.
Analog Output	[BT3563-01 and BT3562-01 only] Measured resistance (displayed value, from 0 to 3.1 V DC)
External interface	External I/O, RS232C (9600, 19200 or 38400 bps), Printer RS-232C (all models), GP-IB (Model BT3563-01, BT3562-01 and 3561-01 only)
Other functions	Over-range display, measurement error detection, self-calibration, dual comparators, key-lock

### ● BT3563, BT3562 and 3561 General Specifications

Operating temperature & humidity	0 to 40°C, 80% rh or less (non-condensating)
Storage temperature & humidity	-10 to 50°C, 80% rh or less (non-condensating)
Guaranteed accuracy temperature & humidity	23°C ±5°C, 80% rh or less (non-condensating)
Operating conditions	Indoors, below 2000 m ASL
Rated supply voltage	100 to 240 V AC (auto-selecting)
Rated supply frequency	50/60 Hz
Rated power consumption	30 VA

Insulation withstand potential	[BT3563(-01), BT3562(-01)] 1.39 kV AC for 15 s (with 10 mA cut-off current) between all mains supply terminals and protective ground terminal 2.224 kV AC for 15 s (with 1 mA cut-off current) between all measurement jacks and interfaces 1.39 kV AC for 15 s (with 1 mA cut-off current) between all measurement jacks and protective ground terminal [3561(-01)] 1.69 kV AC for 15 s (with 10 mA cutoff current) between all mains supply terminals and protective ground, interfaces, and measurement jacks
Dimensions	Approx. 215W × 80H × 295D mm (without projections)
Mass	Approx. 2.4 kg
Accessories	Power Cord (1)
Applicable Standards	Safety EN61010-1 EMC EN61326 EN61000-3-2 EN61000-3-3

### ● BT3563 and BT3562

#### [ Sampling Times ]

Function		EX.FAST	FAST	MEDIUM	SLOW
ΩV	(50Hz)	8ms	24ms	84ms	259ms
	(60Hz)			70ms	253ms
Ω	(50Hz)	4ms	12ms	42ms	157ms
	(60Hz)			35ms	150ms
V	(50Hz)	4ms	12ms	42ms	157ms
	(60Hz)			35ms	150ms

Items in the parentheses ( ) indicate supply frequency settings; Tolerance: ±5 ms

### ● 3561

#### [ Sampling Times ]

Function		EX.FAST	FAST	MEDIUM	SLOW
ΩV	(50Hz)	7ms	23ms	83ms	258ms
	(60Hz)			69ms	252ms
Ω	(50Hz)	4ms	12ms	42ms	157ms
	(60Hz)			35ms	150ms
V	(50Hz)	4ms	12ms	42ms	157ms
	(60Hz)			35ms	150ms

Items in the parentheses ( ) indicate supply frequency settings; Tolerance: ±5 ms

## Measurement Ranges and Accuracy (Guaranteed Accuracy Period: 1 year)

### ● BT3563, BT3562 and 3561 Conditions of Guaranteed Accuracy

Temperature & humidity:

23 °C ±5 °C, 80% rh or less (non-condensating)

Zero-adjustment: After executing zero-adjustment

Warm-up time: At least 30 min.

Self-calibration:

Unless using SLOW sampling, execute self-calibration after warm-up and restrict temperature fluctuations to within ±2 °C after calibration.

### ● About Accuracy

Accuracy is calculated from the reading error (±% rdg.) determined by the measurement value and range, and the digit error (± dgt.).

#### Calculation Example

Measurement value: 1 Ω, Measurement range: 3 Ω

Specified accuracy (from table below): ±0.5% rdg., ±5 dgt.

(A) Reading error (±% rdg.): 1 [Ω] × 0.5% = ±0.005 [Ω]

(B) Digit error (± dgt.): ±5 dgt. = ±0.0005 [Ω] (at 0.0001 Ω resolution)

(C) Total error (A + B): ±0.0055 [Ω]

Applying total error (C) to the measurement value of 1 Ω gives an error limit of 0.9945 to 1.0055 Ω.

### ● BT3563 and BT3562 [Resistance Measurement]

Range	3mΩ	30mΩ	300mΩ	3Ω	30Ω	300Ω	3000Ω
Maximum display Value	3.1000mΩ	31.000mΩ	310.00mΩ	3.1000Ω	31.000Ω	310.00Ω	3100.0Ω
Resolution	0.1μΩ	1μΩ	10μΩ	100μΩ	1mΩ	10mΩ	100mΩ
Measurement Current <sup>*1</sup>	100mA	100mA	10mA	1mA	100μA	10μA	10μA
Measurement Current Frequency	1kHz ±0.2Hz						
Accuracy <sup>*2</sup>	±0.5%rdg.±10dgt.		±0.5%rdg. ±5dgt.				
Temperature coefficient	(±0.05%rdg. ±1dgt.) / °C		(±0.05%rdg. ±0.5dgt.) / °C				
Open-Circuit Voltage	25V peak		7V peak	4V peak			

\*1 Measurement current accuracy is ±10%.

\*2 30mΩ to 3000Ω ranges: Add ±3 dgt. for EX FAST, or ±2 dgt. for FAST and MEDIUM

3mΩ range: Add ±30 dgt. for EX FAST, or ±10 dgt. for FAST, or ±5 dgt. for MEDIUM

### [Voltage Measurement]

Range	6V	60V	300V (only BT3563)
Maximum display Value	±6.00000V	±60.0000V	±300.000V
Resolution	10μV	100μV	1mV
Accuracy <sup>*3</sup>	±0.01%rdg. ±3dgt.		
Temperature coefficient	(±0.001%rdg. ±0.3dgt.) / °C		

\*3 Add ±3 dgt. for EX FAST, or ±2 dgt. for FAST and MEDIUM

### ● 3561 [Resistance Measurement]

Range	300mΩ	3Ω
Maximum display Value	310.00mΩ	3.1000Ω
Resolution	10μΩ	100μΩ
Measurement Current <sup>*4</sup>	10mA	1mA
Measurement Current Frequency	1kHz ±0.2Hz	
Accuracy <sup>*5</sup>	±0.5%rdg. ±5dgt.	
Temperature coefficient	(±0.05%rdg. ±0.5dgt.) / °C	
Open-Circuit Voltage	7V Peak	

\*4 Measurement current accuracy is ±10%.

\*5 Add ±3 dgt. for EX FAST, or ±2 dgt. for FAST and MEDIUM

\*6 Add ±3 dgt. for EX FAST, or ±2 dgt. for FAST and MEDIUM

### ● 3561 [Voltage Measurement]

Range	20V
Maximum display Value	±19.9999V
Resolution	0.1mV
Accuracy <sup>*6</sup>	±0.01%rdg. ±3dgt.
Temperature coefficient	(±0.001%rdg. ±0.3dgt.) / °C

## Option Configurations

### Main unit



**BATTERY HiTESTER BT3563**

**BT3563-01** (with GP-IB and analog output)

**BATTERY HiTESTER BT3562**

**BT3562-01** (with GP-IB and analog output)

**BATTERY HiTESTER 3561**

**3561-01** (with GP-IB)

- Measurement leads are not included. Purchase the appropriate lead option for your application separately.
- The male (system side) of the EXT I/O connector is also available. Please inquire with your HIOKI distributor.

### Options (measurement leads)

**Measurement lead** (for measuring high voltage batteries with Models BT3563 and BT3562)

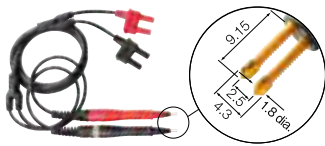

**PIN TYPE LEAD L2100**

A:300 mm, B:172 mm, L:1400 mm  
for high voltage battery measurements, 600 V  
DC max., BT3563 and BT3562 only

**Zero adjustment board** (for L2100 only)



**ZERO ADJUSTMENT BOARD 9454**  
for L2100 only

Cannot be used for zero adjusting the 9770 and 9771 Pin Type Leads

#### About probe length

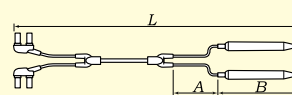

- A: between junction and probe
- B: probe length
- L: between connector and probe tip

**Measurement leads** (for measuring batteries up to 60 V with BT3563, BT3562, or 3561)



**CLIP TYPE LEAD 9287-10**  
A:130 mm, B:83 mm, L:1100 mm, DC70V



**FOUR TERMINAL LEAD 9453**  
A:280 mm, B:118 mm, L:1360 mm, DC60V



**LARGE CLIP TYPE LEAD 9467**  
A:300 mm, B:116 mm, L:1360 mm, DC50V

Not CE marked.  
29mm diameter

**Measurement leads** (3561 only)



**CLIP TYPE LEAD 9452**  
A:220 mm, B:197 mm, L:1360 mm

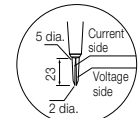

**9452 tip shape**

**Mainly for Small Secondary Batteries** (with very small terminals)

1.8 mm dia. single-axis type for measuring small electrodes

0.2 mm parallel pyramid-type pins for measuring at thru holes and sub-millimeter objects

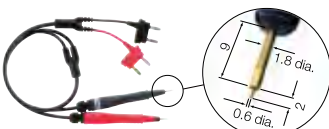

**PIN TYPE LEAD 9770** 9770 tip shape  
A:260 mm, B:140 mm, L:850 mm,  
DC70V

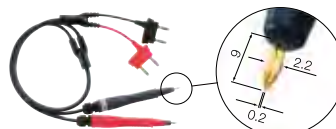

**PIN TYPE LEAD 9771** 9771 tip shape  
A:260 mm, B:138 mm, L:850 mm,  
DC70V

**Measurement leads** (for maximum precision, 3561 only)



**PIN TYPE LEAD 9455**  
A:260 mm, B:136 mm, L:890 mm

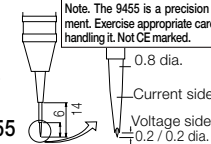

**9455 pin (enlarged)**

Note: The 9455 is a precision instrument. Exercise appropriate care when handling it. Not CE marked.

### Options (Interface Cables)

**Interface (RS-232C and GP-IB) Connection cables**



**RS-232C CABLE 9637**  
9- to 9-pin crossover, 1.8m



**RS-232C CABLE 9638**  
9- to 25-pin crossover, 1.8m



**GP-IB CONNECTOR CABLE 9151-02**  
2m

Note: Company names and Product names appearing in this catalog are trademarks or registered trademarks of various companies.

**HIOKI**  
HIOKI E. E. CORPORATION

Find Quality Products Online at:

[www.GlobalTestSupply.com](http://www.GlobalTestSupply.com)

[sales@GlobalTestSupply.com](mailto:sales@GlobalTestSupply.com)