



226/227

Multifunction Process Calibrator

Find Quality Products Online at:

www.GlobalTestSupply.com

sales@GlobalTestSupply.com

ADT226/227 Multifunction Process Calibrator

-----User Manual

[Version: 2306V01]

Additel Corporation

Find Quality Products Online at:

www.GlobalTestSupply.com

sales@GlobalTestSupply.com

STATEMENT

This user manual provides operating and safety instructions for the ADT226/227 Multifunction process calibrator. To ensure correct operation and safety, please follow the instructions in this manual. Additel Corporation reserves the right to change the contents and other information contained in this manual without notice.

Find Quality Products Online at:

www.GlobalTestSupply.com

sales@GlobalTestSupply.com

Content

1. Introduction	3
1.1 General Introduction	3
1.2 Models and function	4
1.3 Technical Specifications	6
1.3.1 General specifications	6
1.3.2 Electrical Measurement Specifications	8
1.3.3 Electrical Output Specifications	11
1.3.4 RTD Measurement and Source Specifications	13
1.3.5 Thermocouple Measurement and Source specifications	15
1.4 Basic Structure	19
1.5 Power supply description	20
2. Display and functions	22
2.1 Main interface	22
2.2 Control center	23
3. Calibrator	25
3.1 Electrical Measurement	26
3.1.1 DC voltage measurement	26
3.1.2 Current measurement	27
3.1.3 Switch measurement	28
3.1.4 Pulse measurement	28



3.1.5 Frequency measurement.....	28
3.1.6 AC voltage measurement	28
3.1.7 Scaling.....	29
3.1.8 Filter	29
3.1.9 Zeroing	30
3.1.10 Statistics	30
3.2 Pressure measurement.....	30
3.2.1 Pressure measurement settings.....	30
3.2.2 Filter	31
3.2.3 Module information.....	31
3.2.4 Zeroing	32
3.2.5 Statistics	32
3.3 Temperature measurement.....	32
3.3.1 Thermocouple measurement.....	32
3.3.2 Thermocouple settings	33
3.3.3 RTD measurement	33
3.3.4 RTD settings.....	34
3.3.5 Zeroing	35
3.3.6 Statistics	35
3.4 HART calibration.....	35
3.4.1 Search and connection.....	35
3.4.2 HART Setting.....	36

3.4.3 Process variables	38
3.4.4 Diagnosis/ Service	38
3.5 Output	40
3.5.1 Voltage output.....	40
3.5.2 Current output.....	41
3.5.3 Frequency output.....	41
3.5.4 Pulse output	41
3.5.5 Simulate Thermocouple (TC) output.....	42
3.5.6 Simulate RTD output	43
3.5.7 Set point output	44
3.5.8 Ramp output.....	45
3.5.9 Automatic step output.....	46
3.5.10 Manual step output.....	47
3.5.11 Fine adjustment output	47
4. System settings.....	48
4.1 Bluetooth communication.....	48
4.2 Power management.....	48
4.2.1 Brightness	48
4.2.2 Battery information	48
4.2.3 Auto backlight off	48
4.2.4 Auto sleep after backlight off.....	48
4.2.5 Auto power off after sleep.....	49



4.3 Services	49
4.3.1 System calibration	49
4.3.2 Maintenance	50
4.3.3 4.3.3 Restore to factory data	50
4.4 Personalization	50
4.4.1 Sound	50
4.4.2 Language	51
4.4.3 Date & Time	51
4.5 Product information	51
5. Data management	53
6. Task	54
6.1 Calibration pressure devices	54
6.1.1 Dial pressure gauge and digital pressure gauge	54
6.1.2 Pressure transmitter	57
6.1.3 Pressure switch	59
6.1.4 I/P Converter	60
6.2 Calibrate temperature devices	62
6.2.1 Temperature indicator	62
6.2.2 Temperature transmitter	64
6.2.3 Temperature transmitter with sensor	67
6.2.4 Temperature switch	68
6.2.5 Temperature switch with sensor	71

6.3 Calibrate flow devices	72
6.3.1 Delta- pressure flowmeter	72
6.3.2 Instantaneous flowmeter	74
6.3.3 Flow volume totalizers	75
6.3.4 Tachometer/ vortex meters	77
6.4 Calibrate loop devices.....	78
6.4.1 Loop indicators	78
6.4.2 Loop signal source	80
6.4.3 Signal isolator/ converters	81
6.4.4 Limit Switches.....	82
7. Applications.....	85
7.1 Pressure Unit Converter	85
7.2 Leak Test	85
7.3 PSV test.....	86
7.4 Thermal calculator	87
7.5 Sensor library.....	87
7.6 Simulate transmitter	87
7.7 Data logger	88
7.7.1 Logger Management	89
7.7.2 The start of data logging.....	89
7.7.3 The operation of data logging.....	90
7.7.4 Save the data	92



7.8 Differential pressure.....	92
8. HART Communicator.....	94
8.1 HART connection and search.....	94
8.2 HART communicator operation.....	94

Safety instructions

Warning:

To prevent the user from injury, please follow this user manual for use.

To prevent possible fire, electric shock or personal injury, please do as follows:

General:

- ◆ Please read the manual, especially the Safety Instructions before using this product;
- ◆ Use only the correct measurement category (CAT), voltage and current rated probes, test cables for measurement;
- ◆ Please charge the battery when a low battery level is displayed in case of the measurement abnormal;
- ◆ Do not expose the battery to fire or short circuit the battery;
- ◆ The voltage applied between the terminals or between any terminal and the grounding cannot exceed the rated value;
- ◆ Before using the product, please check the appearance of the product for any damage;
- ◆ If the product is damaged or malfunctions, do not use it, and contact Additel;
- ◆ Never use the non-Ex version in an explosive, steam or dust environment;
- ◆ Do not touch the metal part of the probes or test cables during use;
- ◆ Please remove unnecessary probe, cable or other accessories before using the product;
- ◆ Do not use damaged or worn cable.



Attention:

To prevent injury, please obey the instruction manual for use

To prevent possible damage, please do as follows:

- ◆ Do not use the instrument in a high vibration environment;
- ◆ Use only the Additel power adaptor and designated battery models;
- ◆ In case of working with external pressure module, refer to the Safety instructions of its manual.

1. Introduction

1.1 General Introduction

The ADT226/227 series calibrators are a new generation multifunction process calibrator provided by Additel. With the documenting test task built-in, it can significantly improve the efficiency of the testing and calibrating in field and laboratory applications. It combines a plentiful amount of functions in a single device, such as gauge measurement, 3 signal source, loop power, pressure indicator, HART communicator and thermal calculator. Users can perform field calibration, troubleshooting and maintenance by carrying only the ADT227, so that greatly improved the efficiency of field engineers and technicians.

How to contact us

TEL: 1-714-998-6899

Or visit Additel website: www.additel.com



1.2 Models and function

Table 1 Models and function

Models		ADT226	ADT227	ADT227-HART
Measure				
Voltage	mV DC	±300 mV	±300 mV	±300 mV
	V DC	±30 V	±30 V	±30 V
High Voltage	V DC/AC	±300V DC/AC	±300V DC/AC	±300V DC/AC
Current (mA DC)		±30 mA	±30 mA	±30 mA
Resistance		0 - 4000 Ω	0 - 4000 Ω	0 - 4000 Ω
Frequency		0.01 - 50,000 Hz	0.01 - 50,000 Hz	0.01 - 50,000 Hz
Pulse		0 - 9,999,999	0 - 9,999,999	0 - 9,999,999
Limit Switch		•	•	•
Thermocouple TC		-10 - 75 mV	-10 - 75 mV	-10 - 75 mV
Pressure Module Serial Ports		2	2	2
Source / Simulate				
Voltage (V DC)		-15 V ~15 V	-15 V ~15 V	-15 V ~15 V
Current (mA DC)		0 - 25 mA	0 - 25 mA	0 - 25 mA
Resistance		0 - 4000 Ω	0 - 4000 Ω	0 - 4000 Ω



Frequency	0.01 - 50,000 Hz	0.01 - 50,000 Hz	0.01 - 50,000 Hz
Pulse	0 - 9,999,999	0 - 9,999,999	0 - 9,999,999
Thermocouple TC	-10 - 75 mV	-10 - 75 mV	-10 - 75 mV
Recording			
Scaling	•	•	•
Min/Max/Avg/Tare	•	•	•
Hold	•	•	•
Task		•	•
On-demand Logging		10,000 readings	10,000 readings
Features			
Color Touchscreen Display	•	•	•
Top Port Protection	50V Max	50V Max	50V Max
Loop power	24 V	24 V	24 V
Ramp/step	•	•	•
Simulate Transmitter	•	•	•
RTD	•	•	•
Thermocouple TC	•	•	•
Internal CJC	•	•	•



Bluetooth	•	•	•
HART Communication			•
Full HART Communicator			•
Documenting		•	•
IP67 Compliance	•	•	•
Warranty	3 Years	3 Years	3 Years
ISO 17025 Accredited Calibration	•	•	•

1.3 Technical Specifications

1.3.1 General specifications

Table 2 General specifications

Specifications	ADT226	ADT227
Operating Temperature	-10°C to 50°C	
Specification guaranteed temperature	10°C to 30°C	
Storage Temperature	-30°C to 70°C	
Humidity	<95%, non-condensing	
Power supply	6600mAh, 23.8Wh lithium battery, charging time 4~6 hours, battery pack can be charged independently	
User interface	Icon drive menus	
Ports protection voltage	50V max (Only for the top ports)	



Display	5.0 inch 480x800 mm TFT LCD capacitive screen
Maximum altitude	3000 meters
European Compliance	CE Mark
Electrical Connection	Ø4mm sockets and flat mini-jack thermocouple socket
Size	6.97" x 4.13" x 2.04" (177 mm x 105 mm x 52 mm)
Weight	1.6 lb (0.7 kg)
Battery	Rechargeable Li-ion battery (included)
Battery Life	Typically 12 hours
Battery Charge	110V/220V external power adapter included. Battery can be charged external to the unit. Typically charge time is 6-8 hours.
External pressure module	Dual channel aerial plug, can connect two digital pressure modules
Warm-up time	Full specification performance is achieved after a 10 minute warm-up time.
ROHS compliant	Rohs II Directive 2011/65/EU, EN50581:2012
Display rate	3 readings per second
Barometric Accuracy (Built-in barometer)	55Pa
IP protection level	IP67, 1 meter drop test
Communication	Isolate USB-TYPEC (slave), Bluetooth BLE
Calibration	ISO 17025 accredited calibration with data



Warranty	3 years
-----------------	---------

1.3.2 Electrical Measurement Specifications

Table 3 Electrical Measurement Specifications

Specifications	Range	Resolution	Accuracy	
			ADT226	ADT227
Voltage DC	-300 to 300 mV	1 μ V	0.015% RDG + 15 μ V	0.005% RDG + 15 μ V
	-30 to 30 V	0.1 mV	0.015% RDG + 1.5 mV	0.005% RDG + 1.5 mV
	Temperature Coefficient: ± 5 ppm FS/ $^{\circ}$ C (-10 $^{\circ}$ C to 10 $^{\circ}$ C and 30 $^{\circ}$ C to 50 $^{\circ}$ C)			
	Impedance: -300 mV to 300 mV = > 100 M Ω , -30 V to 30 V = >1 M Ω			
DC High Voltage	-300 to 300 V	10 mV	0.05% RDG + 30 mV	0.05% RDG + 30 mV
	Temperature coefficient: ± 25 ppm FS/ $^{\circ}$ C (-10 $^{\circ}$ C to 10 $^{\circ}$ C and 30 $^{\circ}$ C to 50 $^{\circ}$ C)			
	Maximum input voltage = 300 V, IEC61010 300V CATII			
	Common mode rejection: >100 dB (at 50 or 60 Hz)			
	Impedance: > 4 M Ω , DC coupling			
AC High Voltage	300V (40 to 500 Hz)	10 mV	0.5% RDG + 150 mV	0.5% RDG + 150 mV
	Temperature coefficient: $\pm (250 \text{ ppmRDG} + 25 \text{ ppmFS})/ ^{\circ}\text{C}$ -10 $^{\circ}$ C to 10 $^{\circ}$ C and 30 $^{\circ}$ C to 50 $^{\circ}$ C)			
	Maximum input voltage = 300 V, IEC61010 300V CATII			
	9% to 100% of range is suitable for the above accuracy indicators			



	Impedance: >4 MΩ, <100pF, AC coupling			
Current DC	-30 to 30 mA	0.1 μA	0.015% RDG + 1.5 μA	0.01% RDG + 1.5 μA
	Temperature Coefficient: ±5ppm FS/°C (-10°C to 10°C and 30°C to 50°C), Impedance: < 40 Ω			
Resistance (4-Wire)	0 to 400 Ω	1 mΩ	0.015% RDG + 20 mΩ	0.005% RDG + 20 mΩ
	0 to 4000 Ω	10 mΩ	0.015% RDG + 200 mΩ	0.01% RDG + 200 mΩ
	Temperature Coefficient: ±5 ppm FS/°C (-10°C to 10°C and 30°C to 50°C)			
	2-Wire + 50 mΩ, 3-wire+ 10 mΩ			
	Excitation current: 0.2 mA			
Voltage mV (TC)	-10 to 75 mV	0.1 μV	0.015% RDG + 4.0 μV	0.008% RDG + 3.0 μV
	Temperature Coefficient: ±5ppm FS/°C (-10°C to 10°C and 30°C to 50°C)			
	Impedance: >100 MΩ			
Frequency	(0.01 ~ 5)Hz	0.00001Hz	0.005%RDG + 0.00005 Hz	0.002% RDG + 0.00002 Hz
	(5 ~ 50)Hz	0.0001Hz	0.005%RDG + 0.0005 Hz	0.002%RDG + 0.0002 Hz
	(50 ~ 500)Hz	0.001Hz	0.005%RDG + 0.005 Hz	0.002%RDG + 0.002 Hz
	(500 ~ 5000)Hz	0.01Hz	0.005%RDG + 0.05 Hz	0.002%RDG + 0.02 Hz
	(5000 ~ 50000)Hz	0.1Hz	0.005%RDG + 0.5 Hz	0.002%RDG + 0.2 Hz
	Minimum threshold voltage: 2.5 V			
	Supported units: Hz, kHz, MHz, CPM, CPH, s, ms, μs			



Duty Cycle	(1%~99%)@≤10000Hz	0.01%	0.1% kHz + 0.05%
	(5%~99%)@≤50000Hz	0.1%	
Pulse	0 to 9999999	1	N/A
	Optional rising edge and falling edge, minimum threshold voltage: 2.5V		
Switch	Supports dry or wet switches. Voltage range of 3 to 30 V. Response speed < 10ms		

Note 1: When the environmental temperature is (-10~+10) °C and (30~50) °C, the temperature coefficient is:

- (1) Measure of voltage, current, TC and RTD: ±5ppmFS/°C.
- (2) AC High voltage TRMS measurement: ± (250 ppmRDG + 25 ppmFS)/ °C
- (3) DC high voltage measurement: ± 25ppmFS/ °C .

Note 2: Input characteristics:

- (1) Voltage scale: -300~300mV input impedance >100 MΩ;
- (2) Voltage scale: -30~30V input impedance >1MΩ;
- (3) Current measure: input impedance<40Ω;
- (4) TC measure: input impedance >100 MΩ.
- (5) AC High voltage TRMS measurement:
input impedance >4MΩ, <100pF, AC Coupling
maximum input voltage: 300V, IEC61010 300V CATII
applied for: 9-100% FS
- (6) DC high voltage measurement:
input impedance >4MΩ, DC Coupling
maximum input voltage: 300V, IEC61010 300V CATII

CMRR: >100 dB (50 or 60 Hz)

Note 3: The excitation power supply for RTD measure is 0.2mA, and each position has 4-wire, 3-wire and 2-wire methods. The accuracy is as follows:

- (1) The accuracy data given in the table is based on the 4-wire mode;
- (2) The accuracy of the 3-wire method is 10mΩ more than the accuracy of the 4-wire mode;
- (3) The accuracy of the 2-wire method is 50mΩ more than the accuracy of the 4-wire mode.

Note 4: Minimum threshold voltage for frequency and pulse measure: 2.5V

Note 5: Supported frequency units: Hz, kHz, MHz, CPM, CPH, s, ms, us;

Note 6: Optional rising edge or descending edge trigger mode for pulse measurement.

1.3.3 Electrical Output Specifications

Table 4 Electrical Output Specifications

Specifications	Range	Resolution	Accuracy	
			ADT226	ADT227/ ADT227-HART
Voltage DC	150 to 150 mV	5 μV	0.015% RDG + 15uV	0.005% RDG + 15 μV
	-1.5 to 1.5 V	0.05 mV	0.015%RDG + 0.15mV	0.005% RDG + 0.15 mV
	-15 to 15 V	0.5 mV	0.015%RDG + 1.5 mV	0.005% RDG + 1.5 mV
Current DC	0 to 25 mA	0.5 uA	0.015% RDG + 1.2 uA	0.01% RDG + 1.2 μA
Resistance	0 to 400 Ω	10 mΩ	0.015% RDG + 20 mΩ	0.005% RDG + 20 mΩ
	0 to 4000 Ω	100 mΩ	0.015% RDG + 200 mΩ	0.01% RDG + 200 mΩ
Frequency	(0.01 ~ 5) Hz	0.00001 Hz	0.005% RDG + 0.00005 Hz	0.002%RDG + 0.00002 Hz



(Square wave)	(5 ~ 50) Hz	0.0001 Hz	0.005%RDG + 0.0005 Hz	0.002%RDG + 0.0002 Hz
	(50 ~ 500) Hz	0.001 Hz	0.005%RDG + 0.005 Hz	0.002%RDG + 0.002 Hz
	(500 ~ 5000) Hz	0.01 Hz	0.005%RDG + 0.05 Hz	0.002%RDG + 0.02 Hz
	(5000 ~ 50000) Hz	0.1 Hz	0.005%RDG + 0.5 Hz	0.002%RDG + 0.2 Hz
Frequency (Sine wave & Triangular wave)	(0.1~ 50) Hz	0.001 Hz	0.004 Hz	0.002 Hz
	(50 ~ 500) Hz	0.01 Hz	0.04 Hz	0.02 Hz
	(500 ~ 5000) Hz	0.1 Hz	0.4 Hz	0.2 Hz
	(5000 ~ 50000) Hz	1 Hz	4 Hz	2 Hz
Duty Cycle	(1%~99%)@≤10000Hz	0.05%	0.1% / kHz + 0.1%	0.1kHz+0.1%
	(5%~99%)@≤50000Hz	0.5%		
Voltage mV (TC)	-10 to 75 mV	1.5 μV	0.015% RDG + 4.0 μV	0.0008% RDG + 3.0 μV
Pulse	0 to 9999999	1	N/A	
	Optional rising edge and falling edge, minimum threshold voltage: 2.5V			
Loop power (max 25mA)	24V (226/227)	N/A	±1 V	±1 V

Note 1: When the environmental temperature is (-10~+10) °C and (30~50) °C, the temperature coefficient is:

(1) Measure of voltage, current, TC and RTD: ±5ppmFS/°C.

Note 2: Output characteristics:

(1) Voltage output ±150 mV / ±1.5V / ± 15V: maximum load current 10mA, loading effect 50uV/mA;

(2) Current output 0~25mA: maximum open circuit voltage 24V, drive capacity 1kΩ/20mA, maximum external voltage 50V;

(3) Frequency output: positive square wave, adjustable duty cycle, square wave amplitude 0~15V adjustable, amplitude accuracy $\pm 0.2\%FS$, maximum load current 10mA, supported units: Hz, kHz, MHz, CPM, CPH, s, ms; Zero-crossing sine wave / triangular wave amplitude: (0.1 ~ 30) Vp-p adjustable.

(4) There are rising edge and falling edge trigger mode available for pulse measure.

(5) TC output: maximum load current 3mA, loading effect $< 5\mu V/mA$;

(6) RTD output: maximum excitation current: $I_{ex} \cdot 400 < 1.6V$ (0 ~ 400) Ω , $I_{ex} \cdot R_{sim} < 1.6V$ (0 ~ 400) Ω
 minimum excitation current: 0.2 mA@(0 ~ 400) Ω , 0.1 mA@(400 ~ 4000) Ω ;
 1ms pulse excite supported

1.3.4 RTD Measurement and Source Specifications

Table 5 RTD Measurement and Source Specifications

Measure and Source	Temperature Range (°C)		Accuracy(°C)	
			ADT226	ADT227/ ADT227-HART
PT10(385)	-200~850	-200~200	0.62	0.57
		200~600	0.77	0.67
		600~850	0.88	0.75
PT25(385)	-200~850	-200~200	0.29	0.24
		200~600	0.40	0.30
		600~850	0.47	0.34
PT50(385)	-200~850	-200~200	0.18	0.13
		200~600	0.27	0.17



		600~850	0.34	0.20
PT100(385) PT100(391) PT100(3916) PT100(3926)	-200~850	-200~200	0.13	0.08
		200~600	0.21	0.11
		600~850	0.27	0.14
PT200(385)	-200~850	-200~200	0.34	0.32
		200~300	0.37	0.34
		300~600	0.46	0.41
		600~850	0.54	0.48
PT400(385)	-200~850	-200~0	0.17	0.15
		0~200	0.21	0.18
		200~600	0.30	0.25
		600~850	0.37	0.30
PT500(385)	-200~850	-200~200	0.18	0.16
		200~600	0.27	0.22
		600~850	0.34	0.27
PT1000(385)	-200~850	-200~200	0.13	0.10
		200~600	0.21	0.16
		600~850	0.27	0.20



Cu10(427)	-200~260	-200~260	0.59	0.54
Cu50(428)	-200~260	-200~260	0.15	0.11
Cu100(428)	-200~260	-200~260	0.10	0.07
Ni100(617)	-60~180	-60~0	0.06	0.05
Ni100(618)		0~180	0.06	0.05
Ni120 (672)	-80~260	-80~260	0.06	0.04
Ni1000	-50~150	-50~150	0.08	0.07

Note: It complies with the international temperature scale ITS90, depends on the maximum tolerance of the RTD measurement and simulation signal output.

1.3.5 Thermocouple Measurement and Source specifications

Table 6 Thermocouple Measurement and Source Specifications

Measure and Source	Temperature Range (°C)		Accuracy(°C)	
			ADT226	ADT227/ ADT227-HART
S	-50~1768	-50~0	0.96	0.76
		0~100	0.69	0.56
		100~1768	0.64	0.44
R	-50~1768	-50~0	1.02	0.82
		0~200	0.71	0.57
		200~1768	0.56	0.38



B	0~1820	200~300	1.89	1.51
		300~500	1.25	1.00
		500~800	0.78	0.62
		800~1820	0.55	0.43
K	-270~1372	-250~-200	0.97	0.72
		-200~-100	0.30	0.23
		-100~600	0.18	0.12
		600~1372	0.35	0.22
N	-270~1300	-250~-200	1.50	1.14
		-200~-100	0.44	0.33
		-100~1300	0.30	0.19
E	-270~1000	-250~-200	0.54	0.39
		-200~-100	0.20	0.15
		-100~700	0.15	0.09
		700~1000	0.20	0.12
J	-210~1200	-210~-100	0.26	0.19
		-100~700	0.15	0.10
		700~1200	0.25	0.15



T	-270~400	-250~-100	0.74	0.55
		-100~0	0.15	0.12
		0~400	0.11	0.08
C	0~2315	0~1000	0.35	0.24
		1000~1800	0.62	0.40
		1800~2315	1.02	0.65
D	0~2315	0~100	0.39	0.31
		100~1200	0.37	0.25
		1200~2000	0.65	0.42
		2000~2315	1.03	0.65
G	0~2315	50~100	1.12	0.90
		100~200	0.72	0.57
		200~400	0.45	0.35
		400~1500	0.37	0.25
		1500~2315	0.77	0.49
L	-200~900	-200~-100	0.15	0.11
		-100~400	0.13	0.08
		400~900	0.17	0.10



U	-200~600	-200~0	0.28	0.21
		0~600	0.13	0.08
LR	-200~800	-200~0	0.19	0.14
		0~800	0.16	0.10
A	0~2500	0~1200	0.45	0.31
		1200~2000	0.78	0.51
		2000~2500	1.14	0.74

Note: It complies with the international temperature scale ITS90, depends on the maximum tolerance of the TC mV measurement and simulation signal output.

1.4 Basic Structure

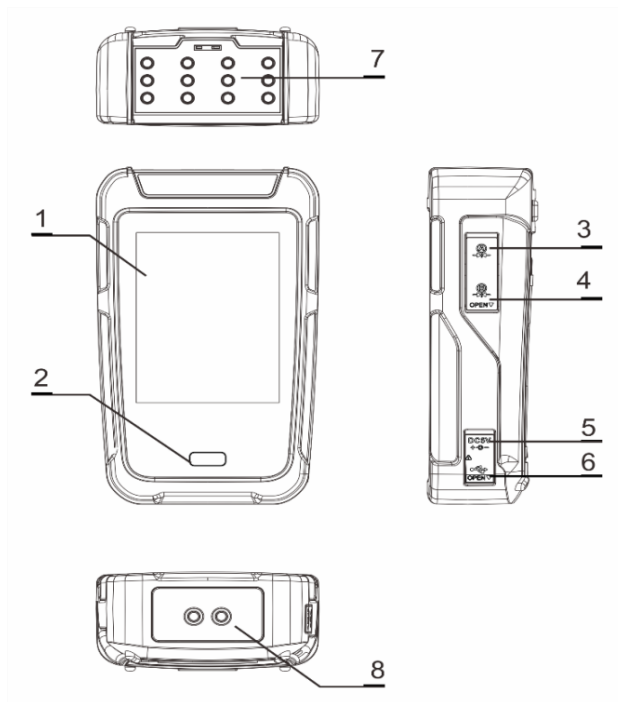

Figure 1 Basic Structure



Table 7 Basic Structure

No.	Part Name	Function
1	Display+ capacitive touch screen	Display area, touchable
2	Power key	For switch on/off
3	Lemo type connection B	Connect to external pressure module.
4	Lemo type connection A	Connect to external pressure module.
5	Adaptor port	Power supply from adaptor.
6	USB slave port	For USB communication.
7	Electrical measurement plug	Connection for electrical measurement, including cables and HART communication.
8	AC voltage measure plug	For measuring AC 300V

1.5 Power supply description

By Li-ion battery

- Li-ion battery is chargeable by external power independently;
- The adapter can quickly adapt to power plugs in various countries;
- Do not expose the battery to fire or short circuit the battery;
- Use only the Additel power adaptor and designated battery models.



Figure 2 Power adaptor



2. Display and functions

After switching on the device, it will go directly to Calibrator function, users can also return to the main page (see Figure 3). The main interface provides access of the functions.

In the main interface, there are three sections from top to bottom: status bar, APPs list and main function guide.



Figure 3 Main interface

1. Status bar: including the time & date, battery, screen lock, external pressure modules, 24V status, Bluetooth, message center. Note: click the status bar to enter the control center, which provides more view and control items.

2. APP's list: shows all the applications provided in the device, including pressure unit converter, leak test, thermal calculator, communicator, PSV test, sensor library, task, data logger, simulate transmitter, etc.
3. Main function guide: the main function guide at the bottom of the interface provides access to three main functions of the device: calibrator, data management, system settings.

2.1 Control center

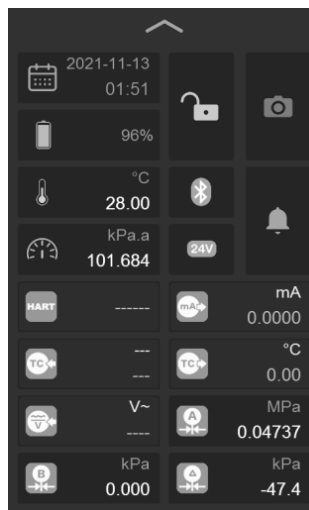

Figure 4 Control center



Click the status bar to enter the control center, which provides functions shortcuts and view for information. As shown in Figure 4.



: Date and time of the system, click to modify;



: Battery level, shows battery remaining, plug the adaptor and change the charge mode;



: Barometric pressure, click to change its unit;



: Internal temperature of the device, click to change its unit;



: Message center, there will be a red dot when abnormal, click to enter the message center and show the abnormal message;



: Bluetooth, click to switch on/ off the Bluetooth;



: 24V power supply, click to switch on/ off the 24V power supply;



: Snapshot, click to take a snapshot;





: Screen lock, click to lock the screen. Icon  means the screen is locked, operate will be not allowed. Go to the control center to unlock.

The lower part in the control center displays the signal status of each channel of the calibrator, followed by electrical measurement (including HART communication), electrical output, temperature measurement, simulate temperature output, AC voltage measurement, external channel A (only displayed when the module is connected), external channel B (only displayed when the module is connected), and differential pressure module channel (displayed only when the DP module is enabled).

3. Calibrator

ADT227 calibrator can be used to calibrate pressure, loop, temperature and flow equipment. The two channels can be displayed in one page. The channel 1 at the top of the screen is used for electrical signal measurement, HART, temperature signal measurement and external pressure module measurement. The channel 2 at the bottom of the screen is used for electrical and temperature signal output, external pressure module measurement. Both two functions support a variety of electrical signal types.

The measured or output signal value is displayed in the middle of the channel. The icon of the signal type and the corresponding range information is displayed on the upper left, click this icon to pop up a menu for switching the signal type; Click the icon  in the upper right corner to set the current channel in the pop-up menu; Click the icon  in the lower right corner to zero the current channel. If the signal type selected in the channel has multiple values for display (for example, when measuring the TC temperature signal, in addition to the temperature value, there are also the original millivolt signal value and the cold junction temperature value), the channel will also display these signal values below the main signal value.

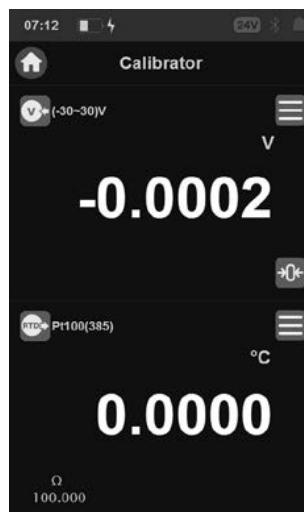

Figure 5 Calibrator interface

3.1 Electrical Measurement

3.1.1 DC voltage measurement

Please connect correctly as shown in the figure (Figure 6 Voltage measurement). Then switch the measurement signal of channel 1 to voltage measurement.

In order to ensure measurement accuracy and adapt to more usage scenarios, two different ranges can be selected for voltage measurement in channel: (-30~30) V and (-300~300) mV, users should select the appropriate measurement

feature according to the use situation.

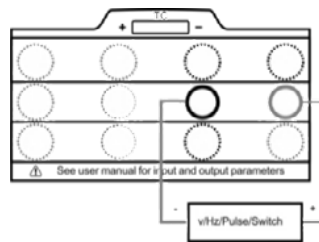

Figure 6 Voltage/ pulse/ frequency/ switch Measurement

3.1.2 Current measurement

Please connect correctly as shown in the figure (Figure 7 Current measurement). Then switch the measurement signal of channel 1 to current measurement (-30~30) mA.

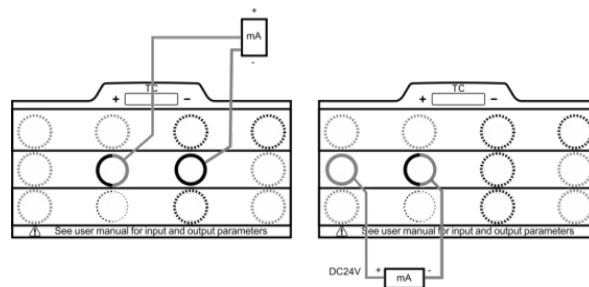

Figure 7 Current Measurement



3.1.3 Switch measurement

The wiring method of the switch measurement function is the same as the voltage measurement, please connect correctly as shown in the figure 6. Then switch the measurement signal of channel 1 to switch measurement.

The switch measurement can work with channel 2, the calibrator can display the measured value of channel 2 when the switch action occurs. For example: channel 1 selects switch measurement, channel 2 selects external pressure module for pressure measure. At this time, when the switch channel detects the on-off state change, it will record the pressure value of channel 2 at this time. In this case, the device can be used to calibrate a typical pressure switch device. Click the switch icon in channel 1 and click the "on-off data" option in the channel menu on the right, user can view the last 10 records in the pop-up on-off data display page.

3.1.4 Pulse measurement

The wiring method of the pulse measurement function is the same as the voltage measurement, please connect correctly as shown in the figure 6. Then switch the measurement signal to pulse measurement (0 ~9999999) Pulse.

Pulse measurement allows the user to set the pulse counting method. In the pulse measurement mode, enter the setting menu to select the counting method.

3.1.5 Frequency measurement

The wiring method of the frequency measurement function is the same as the voltage measurement, please connect correctly as shown in the figure 6. Then switch the measurement signal to frequency measurement (0.01~50k) Hz.

3.1.6 AC voltage measurement

Use the AC voltage measurement port at the bottom of the calibrator to measure the AC voltage, then switch channel 1 to ACM.

3.1.7 Scaling

The scaling function gives the calibrator the ability to convert electrical measurement signals into other signals. Click the menu button  of the measurement channel, select the scaling menu in the pop-up menu, and the parameter configurations related to scaling will be displayed (see Table 8).

Table 8 Scaling configurations

Subject	Valid Value	Description
Enable/disable	Enable/disable	Enable or disable the scaling function
Input range	(-9999999~9999999)	Range before scaling
Output range	(-9999999~9999999)	Range after scaling
Resolution	0/0.1/0.01/0.001	The number of decimal places displayed after scaling
Transfer function	Linear, square or square root	Scaling transfer function

3.1.8 Filter

The calibrator provides two filtering methods: first-order linear filtering and moving average filtering to process data to meet the needs of different usage scenarios. Click the menu button  of the measurement channel, select the filter menu in the pop-up menu, and the filter setting interface will be displayed (see Table 9).

Table 9 Filter configurations

Subject	Valid Value	Description
Enable/disable	Enable/disable	Enable or disable the filter function
Method	first-order linear filter or moving average filter	Filtering algorithm
Filter coefficient	0.01 ~ 1	Only available when the first-order linear filter is selected





Number of samples	1~100	Only available when the moving average filter is selected
De-extremum pairs	0~10	Only available when the moving average filter is selected

3.1.9 Zeroing

The device provides short circuit zeroing function for current/ voltage signal, so as to eliminate the zero drift, supported zeroing range is 1% FS.

3.1.10 Statistics

Click icon  in the channel, and select the statistics in the pop-up menu. Then there will be Max, Min and Avg below the channel 1, click icon  to reset the statistics data.

3.2 Pressure measurement

The pressure measurement function is only available when an external pressure module is connected. This calibrator provides two external module Lemo type connections A and B. When a pressure module is connected to connection A or B, user needs to select on for measurement. Click the pressure unit above the pressure measurement value to switch the pressure unit in the pop-up unit selection interface.

3.2.1 Pressure measurement settings

Click the menu button  in the pressure measurement channel and click the "Settings" menu in the pop-up menu to set the pressure type, resolution, stability, tare and other functions of the current pressure measurement channel, see Table 10.

Table 10 Pressure measurement settings

Subject	Valid Value	Description
Resolution	4/5/6	Resolution of current measurement channel
Pressure type	Gauge/absolute	Current measurement channel pressure type
Measurement frequency*	1~10Hz	Data acquisition frequency of the current measurement channel
Stability enable	Enable/disable	Whether to turn on the stability judgment function
Stability value	0.003-1	A value for judging whether the pressure is stable. If the measured value fluctuates less than this value within the stable time, the calibrator will judge as stable
Stabilization time	1-60	Time to judge the pressure stability
Tare enable	Enable/disable	Enable or disable tare function
Tare value	(<-9999999~9999999)	Correction value of the tare function
Tare units	Pressure units	All pressure units

*Note: Only available for some of the external pressure module.

3.2.2 Filter

See paragraph 3.1.8.

3.2.3 Module information

The pressure measurement provides function of view the information of external pressure module, click icon  in the pressure measurement channel, and select module information in the pop-up menu to view the information.



3.2.4 Zeroing

In the gauge pressure mode, when the device is vented, it can be zeroed if there is deviation in zero point, so as to eliminate the zero drift, supported zero range is 1% FS.

3.2.5 Statistics

See paragraph 3.1.10.

3.3 Temperature measurement

The calibrator supports thermocouple (TC) and thermal resistance (RTD) temperature measurement.

3.3.1 Thermocouple measurement

The connection of thermocouple measurement is shown in the Figure 8 Thermocouple measurement. Then click the features switching menu of channel 1 and select the TC measurement.

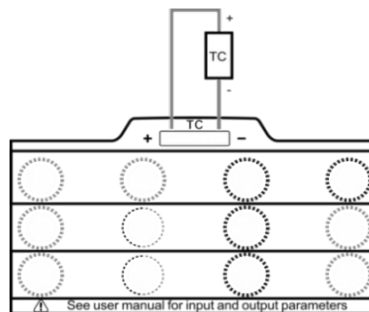

Figure 8 Thermocouple measurement

3.3.2 Thermocouple settings

Click the "Setup" button of the thermocouple measurement channel to set various parameters for the thermocouple measurement function, see Table 11.

Table 11 TC settings

Subject	Valid Value	Description
Sensor type	mV/ All supported TC types	Select the type of thermocouple sensor
Cold junction type	Auto/Fixed	Select the cold junction compensation method, auto means to use the built-in cold junction sensor of the calibrator
Ext CJC value	-80~300	Set customer value for the cold junction compensation value, only available when user selects fixed as the cold junction type
Temperature unit	K / °F/ °C	Temperature unit selection
Resolution	0/0.1/0.01/0.001	Temperature display resolution

3.3.3 RTD measurement

The connection of RTD measurement is shown in the Figure 9. Then click the features switching menu of channel 1 and select the RTD measurement.

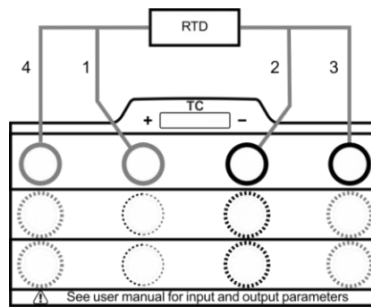

Figure 9 RTD measurement

3.3.4 RTD settings

Click the "Setup" button of the RTD measurement channel to set various parameters for the RTD measurement function. See Table 12.

Table 12 RTD measurement settings

Item	Valid Value	Comment
Sensor type	Ω /All supported RTD types	Select the type of thermal resistance sensor
Wires	2/3/4	Select the RTD wire
Scale	400 Ω /4000 Ω	Available for Ω sensor
Temperature unit	K / °F/ °C	Temperature unit selection
Resolution	0/0.1/0.01/0.001	Temperature display resolution

3.3.5 Zeroing

See paragraph 3.1.8.

3.3.6 Statistics

See paragraph 3.1.10.

3.4 HART calibration

The device provides HART bus communication, using the simplified DD file, provide general settings, service and calibration for HART temperature and pressure transmitters. It is recommended to read the transmitter's manual before use.

Note: the calibrator will always be the master during communicating with the HART device. In order to avoid harm to the controlling system, please separate the HART device from the controlling system before connecting the calibrator with the HART device.

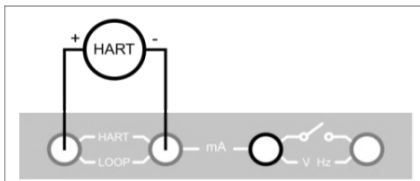

Figure 10 Internal source + internal resistor

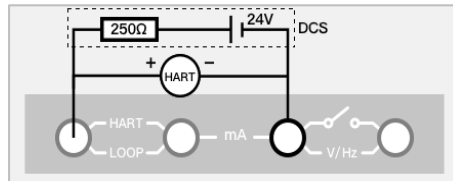

Figure 11 External source + external resistor

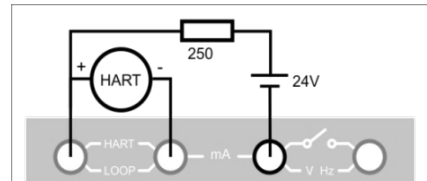



Figure 12 External source + external resistor (supports loop current measurement)

3.4.1 Search and connection

Switch to HART on the Calibrator page, the calibrator will automatically use the last selected power supply configuration (default is the internal resistance and internal source), and search for the address "0". After searching for the HART device, it will automatically connect and display its value. Click the menu icon  to select search, or click the



HART measurement channel screen when the HART device is not connected to enter the HART power supply configuration interface. The configuration provided by the calibrator is as Figure 10, 11 and 12.

After selecting the configuration, go to the search interface. Start searching for HART devices from address "0", if the search is success, it will stop searching and display the HART device list and main information, otherwise the calibrator will start searching from address "1" until address "15", After completing the search, the calibrator will list all the searched HART devices, and can display up to 15 HART devices at the same time.

3.4.2 HART Setting

In the Calibrator page, switch to HART gear and click icon  to go to the settings, including device information, sensor information and device output, see Table 13.

Table 13 HART settings

Subject	Parameter	Description and valid value
Device information	Label	Support letter, symbol and number, the length cannot be greater than 8 characters
	Date	Any date supported by transmitter
	Information	Support letter, symbol and number, the length cannot be greater than 32 characters
	Description	Support letter, symbol and number, the length cannot be greater than 16 characters
	Final Assembly Number	Support integer, the length cannot be greater than 8 characters
	Preambles	Integer 5-20
	Manufacturer	Read only
	Device type	Read only
Device ID	Read only	



	Write-protect	Read only
	Universal Version	Read only
	Software Version	Read only
	Hardware Version	Read only
	Device Version	Read only
Sensor*	Sensor S/N	Read only
	Sensor unit	Read only
	Sensor lower limit	Read only
	Sensor upper limit	Read only
	Sensor minimum scale	Read only
Device output	Process Variable/Range Units	Can be changed to any unit supported by transmitter, the upper/ lower limit are along with
	Lower Limit of PV Range	Cannot exceed the sensor lower limit
	Upper limit of PV Range	Cannot exceed the sensor upper limit
	Transfer Function	Linear or square root
	damp	Data filter time, unit is S
	Poll Address	Default 0, integer 0-15
	Burst Mode	Enable or disable, depends on the transmitter



	Burst Command	Set burst command
	Alarm State	Read only

Note: The temperature transmitter can provide additional setting items such as sensor type, wires, sensor status, CJC type and value according to the function supported by the transmitter.

3.4.3 Process variables

In the HART page choose electrical measurement, click icon  and choose Process variables, it can show process variables, output current, percentage, second variable, third variable and loop current. Among these, the units of second and third variable depend on different devices.

3.4.4 Diagnosis/ Service

1. Current loop test
 - ◆ Click the icon  to select Diagnosis/ Service and enter the current loop test. Carry out the current loop test, the value range of this parameter is (4-20) mA.
 - ◆ The HART measurement value at the top of the calibrator page is the real value of the current loop.
2. Zeroing (only for pressure transmitter)
 - ◆ Select zeroing in the HART Diagnosis/ Service interface to enter the zeroing interface.
 - ◆ Ensure that the current measured value is close enough to the zero point, otherwise it may cause zero failure.
3. Current Adjustment
 - ◆ By adjusting the scaling coefficient of current output of the transmitter, the output current value of the transmitter will keep the same as the actual loop current output value.
 - ◆ It provides adjustment of D/A zero point (4mA) and D/A full scale (20mA): press the screen to get the value for adjustment.

4. Sensor adjustment

- ◆ Sensor adjustment is to adjust the PV of the transmitter, usually including one or two adjustment points (lower point and upper point). Some transmitters do not support this (please refer to the transmitter's manual).

- ◆ Lower point adjustment

- (1) First provide external standard source to the transmitter manually. After stabilized, input the standard source display value directly by the number keys; For the pressure transmitter, the standard source display value can be directly obtained through the external pressure module. In this case, click the Get icon on the calibration page to get the standard value of the pressure module directly.

Note: For some transmitters, it is not needed to input the adjustment value, the transmitter automatically uses the upper and lower limits of the range (the lower limit of the range corresponds to the lower point adjustment value, and the upper limit of the range corresponds to the upper point adjustment value) as the adjustment value. In this case, just input any value;

- (2) Execute the Trim command. After that, the PV value will change according to the trimmed point value.

- ◆ Upper point adjustment

Same as the lower point adjustment.

- ◆ Single point adjustment

Same as the lower point adjustment.

- ◆ Restore to factory setting

After selecting "Restore Factory", there will come to ask "Are you sure to perform this operation?", click OK to continue. After that, the transmitter's lower and upper points values will be restored to the factory setting.

Note: The current loop test and D/A adjustment is only available when the transmitter address is 0.

Note: The sensor adjustment provides corresponding support items according to the transmitter function.

Note: If the HART transmitter used does not have all the above functions, contact the manufacturer.



3.5 Output

The calibrator provides a variety of electrical signal output and analog temperature output functions to cope with various usage scenarios and different devices under test.

The output function of the calibrator not only supports manual setting of set points for signal output, but also provides two automatic output functions: automatic ramp output and automatic step output, and two convenient manual output functions: manual step output and manual fine-tuning output.

3.5.1 Voltage output

The connection of voltage output is shown in the Figure 13 Voltage, frequency, pulse output. Then click the gear switching menu of channel 2 and select the (0~15V).

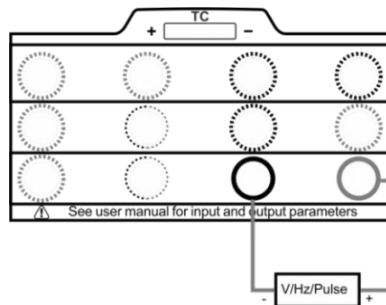

Figure 13 Voltage, frequency, pulse output

3.5.2 Current output

The connection of voltage output is shown in the Figure 14 Current output. Then click the gear switching menu of channel 2 and select the (0~25)mA .

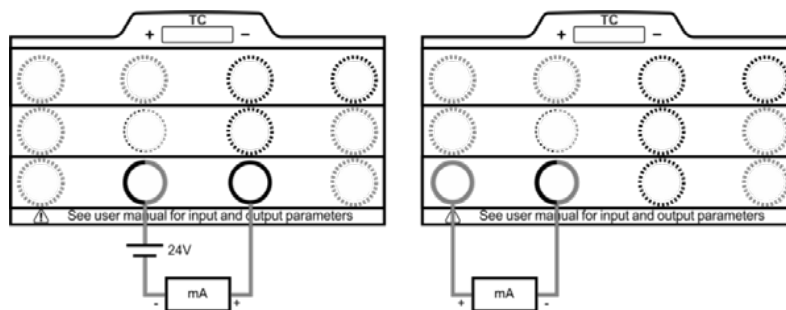

Figure 14 Current output

3.5.3 Frequency output

The connection of frequency output is shown in the Figure 13 Voltage, frequency, pulse output. Then click the gear switching menu of channel 2 and select the (0.01~50k)Hz.

The frequency output function provides a setting menu, in which the amplitude of the frequency output can be set.

3.5.4 Pulse output

The wiring method of using the pulse output function is the same as the voltage output (Figure 13 voltage/frequency/pulse output). After correct wiring as shown in the figure, click to expand the features switching menu of channel 2 and select (1~9999999) to switch to the pulse output gear. The pulse output provides a setting menu, and the amplitude and frequency of the pulse output can be set in the setting menu.

3.5.5 Simulate Thermocouple (TC) output

The wiring method of simulating TC output is shown in the figure (Figure 15 Simulate thermocouple output). After correct wiring as shown in the figure, click the features switching menu of channel 2 and select the TC output to use the simulate thermocouple output function.

Click the "Settings" menu item in the simulate TC output menu to enter the simulate TC setting menu. The setting menu provides a variety of settable parameters for the simulate TC output function, see Table 14.

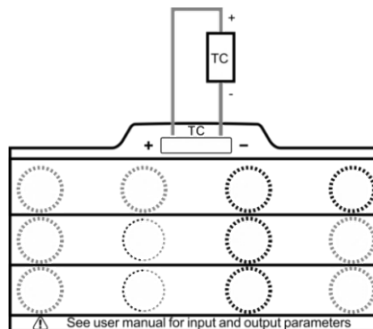

Figure 15 Simulate Thermocouple Output

Table 14 TC Output Setting

Subject	Valid Value	Description
Sensor Type	mV/ TC sensor	Select sensor type
Cold junction type	Auto/ Fix	Select cold junction(CJC) type, Auto means internal CJC
CJC value	-80~300	Available when the cold junction type is fixed
Temp Unit	K / °F/ °C	Select the temperature unit
Decimal digits	0/0.1/0.01/0.001	Decimal accuracy of temperature display

3.5.6 Simulate RTD output

The wiring method of analog thermal resistance output gear is shown in the figure (Figure 16 simulate RTD output). After correct wiring as shown in the figure, click the features switching menu of channel 1 and select the RTD output to use the simulate RTD output function.

Click the "Settings" menu item in the menu of the simulate RTD output to enter the simulate RTD setting menu. The setting menu provides a variety of settable parameters for the simulate RTD output function.

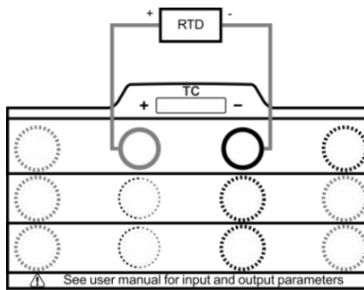

Figure 16 Simulate RTD Output

Table 15 RTD Output Settings

Subject	Valid Value	Description
Sensor Type	Ω /RTD sensor	Select RTD sensor
Scale	400 Ω /4000 Ω / Auto	Available for sensor type Ω
Temp. Unit	K / °F / °C	Select the temperature unit
Resolution	0/0.1/0.01/0.001	Decimal accuracy of temperature display

3.5.7 Set point output

Click the signal output value in channel 2 of the calibrator, and input the set point value you want to output in the pop-up set point input keyboard, and click the confirm button to set the output value of the current gear.

3.5.8 Ramp output

The three electrical output features of voltage, current, and frequency of the calibrator and the two simulate temperature output features of simulate thermocouple and simulate thermal resistance all support automatic ramp output mode. The Ramp can increase or decrease the output value smoothly and continuously. In fact, a small step value is used to form a Ramp signal, which is represented by a Ramp gradient in the calibrator. The calibrator will automatically calculate the Ramp gradient according to the setting start and end values of the Ramp and the rise and fall time. When the start value and end value are fixed, the longer the ramp time, the slower the ramp output and the smaller the ramp gradient.

A complete ramp output stroke includes an up stroke (from the start value ramp to the end value) and a down stroke (from the end value ramp to the start value), when the rise time and fall time are the same, the actual output points of the up stroke and the down stroke are symmetrical one by one. Click icon  to select ramp output and go to the settings, as shown in Table 16.

Table 16 Ramp Output Settings

Subject	Valid Value	Description
Range	Numbers	Ramp start and end value
Rise time	(1~999999)	Up stroke run time
Fall time	(1~999999)	Down stroke run time
High point dwell	(0~999999)	High point dwell time
Low point dwell	(0~999999)	low point dwell time
Cycle index	(0~100)	Ramp cycle index (a complete up and down stroke is a cycle), if this item is set to 0, it means an infinite cycle.



3.5.9 Automatic step output

The three electrical signal output gears of voltage, current, and frequency of the calibrator and the two simulate output gears all support automatic step output mode. In the automatic step output mode, the calibrator outputs signals in sequence according to the output points set by the user. The automatic step function provides flexible setting items to control the step output behavior and create different types of output points. As shown in Table 18.

Table 17 Automatic step output settings

Subject	Valid Value	Description
Stroke type	One way/ round	Select stroke type
Cycle times	(0~100)	Automatic step cycle times, if set 0, it means infinite loop
Cycle interval	(0~999999)	Interval time between cycles
Dwell time	(0~999999)	Dwell time between step points
Step mode	Step point/ percentage/ engineering unit/ custom	Select step mode
Number of step points	(2~16)	Number of step points, available for Step point mode
Step size	Percentage: 7~100 Engineering unit: dynamic range	Step size, available for percentage/ engineering unit
Step point list	Step point	Add or delete set points, available for custom step mode
Scale	Numbers	Lower and upper point of the automatic step scale

3.5.10 Manual step output

The current, voltage and frequency in the output gear, and the simulate TC, simulate RTD of the calibrator can all be output using the manual step function. Open the setting menu of the corresponding gear in the above gears and click the "Manual step" menu item to enter the manual step mode. The manual step mode allows users to customize the manual step output range, and output according to any percentage step. Click the left or right button under the channel to adjust the output value according to the current set step.



Click the step range value in the middle of the left and right buttons under the channel to pop up the range input interface, where the user can customize the output range of the manual step, and the customized step output range cannot exceed the output range of the current signal gear.

The step length setting menu button  of manual step is at the bottom right of channel 2, click this button to select the step length of 25%, 100%, or manually input a custom step length by the user.

Click the button  at the top right of channel 2 to exit manual step mode.

3.5.11 Fine adjustment output

The current, voltage, frequency and simulate temperature output gears of the calibrator output gear can all be output in the fine-adjustment output mode. In the above gears, open the setting menu of the corresponding gear and click the "fine adjustment" menu item to enter the fine adjustment output mode. In the fine-adjustment output mode, users can adjust the output value bit by bit as needed to achieve the purpose of fine-adjustment the output value.

In the fine-adjustment mode, click the value in the middle of the channel to move the cursor, and click the up and down icon  on the right side of the channel to adjust the value of the current cursor position. In the process of adjusting the output value using the fine-tuning output mode, the output value cannot exceed the output range of the current signal gear. Click the icon  on the upper right of channel 2 to exit the fine-tuning output mode.

4. System settings

On the main page of the device, click the icon  in the right bottom to enter the system setting interface. It includes Bluetooth, power management, system calibration, services, personalization and product information.

4.1 Bluetooth communication

The calibrator has the function of Bluetooth communication. Click the "Bluetooth Communication" menu item in the system setting interface to enter the Bluetooth communication setting interface. The Bluetooth communication setting interface provides the enabling and disabling of the Bluetooth communication function and the query function of the Bluetooth device name and physical address.

4.2 Power management

4.2.1 Brightness

Change the LCD's brightness by adjusting the brightness bar.

4.2.2 Battery information

Show the current battery connection status and information.

4.2.3 Auto backlight off

- ◆ The backlight turns to lowest automatically after a certain period of time that no keypad operation and communication.
- ◆ It is supported to set Never, 30s, 1 min, 5mins, 15mins and 30mins.
- ◆ After the backlight closed, the first press to the keypad will only activate the backlight, only after this can the press takes effect.

4.2.4 Auto sleep after backlight off

- ◆ The backlight turns off after the set time that no keypad and communication operation. Then automatically start timing to sleep, and automatically go to sleep when time is over.

-
- ◆ It is supported to set Never, 1min, 5mins, 15mins and 30mins.
 - ◆ When using AC adapter, the calibrator cannot auto sleep.
 - ◆ This function will be invalid when performing Pressure control, Auto step or Task.
 - ◆ The Auto sleep will be invalid when the Auto backlight off is set to Never.

4.2.5 Auto power off after sleep

- ◆ The backlight will be turned off if there is no keypad and communication operation within the set time, and the automatic shutdown timer will start after the start of sleep. After reaching the set time, the automatic shutdown will take effect.
- ◆ It is supported to set Never, 5mins, 15mins, 30mins, 1hour and 2hours.
- ◆ When using AC adapter, the calibrator cannot auto power off.
- ◆ This function will be invalid when performing Pressure control, Auto step or Task.
- ◆ The Auto power off will be invalid when the Auto backlight off is set to Never.

4.3 Services

4.3.1 System calibration

Click the "System Calibration" menu item in the system setting interface, and enter the calibration password "123456" in the pop-up password input box to enter the system calibration interface. In the system calibration interface, you can calibrate all the measurement and output signal gears in the device. The calibration process is as follows:

1. Select the gear to be calibrated in the signal gear list.
2. Use a high-precision reference, after fully warming up, follow the calibration guide in the interface and click the "Start" button to start the calibration.
3. According to the reference calibration point provided on the interface, select the appropriate standard value and enter it.



-
4. Click the "Finish" button to send the calibration data to the module to complete the calibration.
 5. Click the "Restore to factory data" button at the bottom of the calibration interface to restore the factory calibration data of the device. Click the "Cancel Zero" button below to clear data of the current signal gear.

4.3.2 Maintenance

Enter the password for this function, default password is 123456.

- ◆ Maintenance record: view and edit maintenance information.
- ◆ Calibration record: view the calibration history.
- ◆ Pressure module overpressure record: view the pressure module overpressure information.
- ◆ Operation information: view barometric pressure, mainboard and battery information.

4.3.3 Restore to factory data

Enter the password for this function, default password is 123456.

- ◆ Restore to the factory data will not restore the system calibration data.

4.4 Personalization

4.4.1 Sound

Change the sound level by adjusting the volume bar. It also provides sound configuration, as in Table 19.

Table 18 Sound settings

Subject	Valid Value	Comment
Touch sound	On / Off	Touch sound setting
Prompt sound	On / Off	Prompt sound setting
Over range sound	On / Off	Over range sound setting

Snapshot sound	On / Off	Snapshot sound setting
Stable sound	On / Off	Stable sound

4.4.2 Language

The device provides a multi-language user interface. Use this menu to change from the provided languages.

- ◆ After the language is selected, the device needs to be restarted for the changes to take effect.

4.4.3 Date & Time

The device provides customizable settings for time and date, as shown in Table 20.

Table 19 Date & time

Subject	Valid Value	Comment
Date	2020-1-1 ~ 2048-12-31	Date setting
Time	00:00 ~ 23:59	Time setting
Date format	Y-M-D / M-D-Y / D-M-Y	Date format setting
Separator	-, /, .	Date separator setting
Time zone	UTC±00:00~12:00	Set device time zone
24 hours	enable	24-hour or 12-hour format

4.5 Product information

Product information is read-only information, includes basic information and the module information.

- ◆ Basic information: including model, serial number and system version information.
- ◆ Module information: including Bluetooth, electrical board version, electrical output board version, temperature board version, ACM board version.



-
- ◆ External module information: including external module A and external module B.



5. Data management

- ◆ Classified management by functional modules, the data saved by each function is kept under the corresponding item, which is convenient for users;
- ◆ The functional modules that can save data files include: snapshot, pressure leak test, etc;
- ◆ Users can delete the data in batches.

6. Task

The calibrator provides a powerful task function, which can realize fully automatic calibration. At the same time, the calibration data can be automatically collected, stored, and analyzed, and it can be easily executed and viewed repeatedly. Click the task icon  on the main interface of the device to enter the task interface.

The documentary task provides task types for four types of equipment: pressure, temperature, flow and loop. There are multiple detailed classifications under each task type, and a total of 19 types of DUTs are supported. The process of using the document task function is as follows:

- (1) Create task: Click the add task button at the bottom left of the interface, and click the task type you want to create in the pop-up DUT type selection interface.
- (2) According to the task creation interface presented on the interface, input the information needed to create the task accurately and in detail (for example: task name, DUT range, etc.). After completing the information, click the OK button  to save the task information. The tasks created after the task information is saved will be added to the task list in the main interface of the task.
- (3) Select the task just created, and click the button  to run the task. Complete the configuration required for task operation and execute the task according to the guidance of the task operation interface.
- (4) After the task is executed, click the save button  and complete the information required for saving the task data in the pop-up task saving interface. Click the confirm button to save the task data.

6.1 Calibration pressure devices

6.1.1 Dial pressure gauge and digital pressure gauge

1. Connect to DUT

Connect the external pressure module to the Lemo type connection A or B.

2. Create the task

Create the corresponding DUT tasks as described above, and fulfill the necessary information.

Table 20 Pressure gauge task setting

Subject	Valid value	Description
Name	Numbers, letters, symbols	Task name
S/N	Numbers, letters, symbols	Task S/N
Model	Numbers, letters, symbols	Model of DUT
Pressure type	GP/AP/DP	Pressure type of DUT
Input range	Numbers	Input range of DUT
Accuracy	0.06%,0.1%,0.16%,0.25%,0.4%, 0.6%,1%,1.6%,2.5%,4%,custom	Accuracy of DUT. If choose custom, the input number means the accuracy level of the dial pressure gauge. For example: input 1.5 for gauge level of 1.5, the range is (0.001~100)
Division value	0.05/ custom	The minimum resolution of DUT (0.001-100 for custom)
Owner	Numbers, letters, symbols	Owner of DUT
Location	Numbers, letters, symbols	Location of DUT
Note	Numbers, letters, symbols	Additional information

3. Task setting



After starting the task, go to the task information interface and set the required information for the task to run. If multiple pressure modules are connected, you will also need to select which module to use to perform the task.



Table 21 Task running setting

Subject	Valid value	Description
Set point list	The effective value of the set point pressure depends on the pressure range of the DUT; up to 17 points can be set	Set the calibration point for this task, and the calibrator will automatically set the default calibration point into equal difference according to the range of the DUT and the number of set points. However, you can click the "Set Point List" item to manually set them. At this time, the unit of the set point is consistent with the unit of the DUT. Use the arrow button on the bottom of the screen, or click the number of set points and then enter the number of set points through the keyboard to change the number of set points, or modify a set point individually.
Cycle count	1,2,3	Cycles during calibration
Strokes	One way/ Round trip	Stroke during calibration
Tap	On/ off	Tap on or off

4. Start the task

- ◆ Click Start to start the task.
- ◆ Click button  or  to switch between lines mode and table mode.
- ◆ Calibration process:
 - (1) After the pressure is controlled to the first set point by the device, read and enter the displayed value of the DUT on the task interface.
 - (2) click Right icon to go to the next point.

(3) Repeat step 1 and 2 until the whole task is finished.

5. Finish the task

After the task is finished, the task report will automatically come up. In the task report page, you can view the detailed data of each set point. Click the save button  at the bottom right of the interface to fulfill in the information required, and save the task data of the result.

Table 22 Save task data setting

Subject	Valid value	Description
Operator	Numbers, letters, symbols	Information for operator
Date and time	Valid date and time	Date and time of the task performing
Temperature	Number(°C as unit)	Ambient temperature when task performing
Humidity	Number(%RH as unit)	Ambient humidity when task performing
Save as	As found/ As left/ Both	Result type

6.1.2 Pressure transmitter

1. Connect to DUT

- ◆ Connect the external pressure module to the Lemo type connection A or B.
- ◆ Connect the DUT output with calibrator's electrical module according to DUT output signal type. (current: figure 7/voltage: figure 6/HART: figure 10 or 11)

2. Create the task

Create the corresponding DUT tasks as described above, and fulfill the necessary information.



Table 23 Pressure transmitter task setting

Subject	Valid value	Description
Name	Numbers, letters, symbols	Task name
S/N	Numbers, letters, symbols	Task S/N
Model	Numbers, letters, symbols	Model of DUT
Pressure type	GP/AP/DP	Pressure type of DUT
Input	Numbers	Input range of DUT
Output	Analog signal: 4~20mA,0~10mA,0~20mA,1~5V,0~5V,0~10V,custom	Output range of DUT
	HART device: host variable, percentage, output current, loop current	
Accuracy	0.05%,0.1%,0.2%,0.5%, 1%,1.5%,2%,2.5%,custom	Accuracy of DUT. If choose custom, the input number means the accuracy level of this pressure transmitter.
Transfer function	Linear / square / square root	Transfer function of the DUT signal
Owner	Numbers, letters, symbols	Owner of DUT
Location	Numbers, letters, symbols	Location of DUT
Note	Numbers, letters, symbols	Additional information

3. Task setting

Refer to the task setting in paragraph 6.1.1.3.

4. Start the task

For part of the content, refer to Start the task in paragraph 6.1.1.4.

The calibrator will automatically use the measured value of the voltage measurement, current measurement or the HART measurement according to the DUT output type set by the user, without manually input.

5. Finish the task

Refer to Finish the task in paragraph 6.1.1.5.

6.1.3 Pressure switch

1. Connect to DUT

Connect the external pressure module to the Lemo type connection A or B. Connect the DUT output with calibrator's electrical module. (Figure 6)

2. Create the task

Create the corresponding DUT tasks as described above, and fulfill the necessary information

Table 24 Pressure switch task setting

Subject	Valid value	Description
Name	Numbers, letters, symbols	Task name
S/N	Numbers, letters, symbols	Task S/N
Model	Numbers, letters, symbols	Model of DUT
Pressure type	GP/AP/DP	Pressure type of DUT
Range	Numbers	Input range of DUT
Accuracy	0.5%,1%,1.5%,2%, 2.5%,4%,custom	Accuracy of DUT. If choose custom, the input number means the accuracy level of this pressure switch.



Set point	Numbers	Action set point of the DUT
Set action type	Open / closed	Action type of the DUT
Dead band	Numbers	Dead band range of the DUT
Owner	Numbers, letters, symbols	Owner of DUT
Location	Numbers, letters, symbols	Location of DUT
Note	Numbers, letters, symbols	Additional information

3. Task setting

Refer to the task setting in paragraph 6.1.1.3.

4. Start the task

- ◆ For part of the content, refer to Start the task in paragraph 6.1.1.4
- ◆ When the pressure switch moves (open/close) during the task, the calibrator will automatically record the pressure value at the moment of the action, without manually input.

5. Finish the task

Refer to Finish the task in paragraph 6.1.1.5.

6.1.4 I/P Converter

1. Connect to DUT

- ◆ Connect the external pressure module to the Lemo type connection A or B.
- ◆ As shown in the Figure 17, connect the DUT output with calibrator's electrical module.

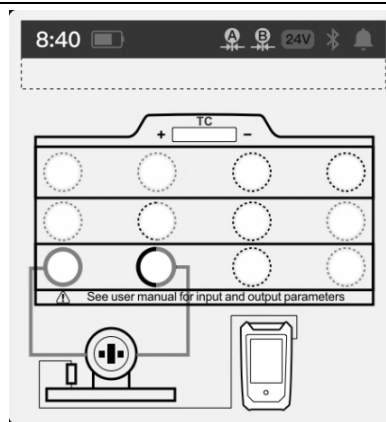

Figure 17 I/P converter

2. Create the task

Create the corresponding DUT tasks as described above, and fulfill the necessary information.

Table 25 I/P Converter task setting

Subject	Valid value	Description
Name	Numbers, letters, symbols	Task name
S/N	Numbers, letters, symbols	Task S/N
Model	Numbers, letters, symbols	Model of DUT
Pressure type	GP/AP/DP	Pressure type of DUT



Input	4~20mA,4~12mA,12~20mA,custom	Input range of DUT
Output	Numbers	Output range of DUT
Accuracy	0.025%,0.05%,0.1%,0.16%,0.25%, 0.4%,1%,1.6%,2.5%,4%, custom	Accuracy of DUT. If choose custom, the input number means the accuracy level of this I/P converter.
Transfer function	Linear / square / square root	Transfer function of the DUT
Owner	Numbers, letters, symbols	Owner of DUT
Location	Numbers, letters, symbols	Location of DUT
Note	Numbers, letters, symbols	Additional information

3. Task setting

Refer to the task setting in paragraph 6.1.1.3.

4. Start the task

- ◆ For part of the content, refer to Start the task in paragraph 6.1.1.4.
- ◆ During the task performing, the calibrator will output the corresponding current according to the set point list, and automatically record the DUT output pressure, without manual input.

5. Finish the task

Refer to Finish the task in paragraph 6.1.1.5.

6.2 Calibrate temperature devices

6.2.1 Temperature indicator

1. Connect to DUT

Connect the DUT input to the TC output (Figure 15) or RTD (Figure 16) output of the calibrator.

2. Create the task

Create the corresponding DUT tasks as described above, and fulfill the necessary information.

Table 26 Temperature indicator task setting

Subject	Valid value	Description
Name	Numbers, letters, symbols	Task name
S/N	Numbers, letters, symbols	Task S/N
Model	Numbers, letters, symbols	Model of DUT
Input	Numbers	Input range of DUT, switchable temperature units
Sensor type	TCs or RTDs optional	Sensor type of the DUT
Accuracy	0.06%,0.1%,0.16%,0.25%,0.4%, 0.6%,1%,1.6%,2.5%,4%, custom	Accuracy of DUT
Owner	Numbers, letters, symbols	Owner of DUT
Location	Numbers, letters, symbols	Location of DUT
Note	Numbers, letters, symbols	Additional information

3. Task setting

Refer to the task setting in paragraph 6.1.1.3.

4. Start the task

- ◆ For part of the content, refer to Start the task in paragraph 6.1.1.4.
- ◆ During the task performing, the calibrator simulates and outputs a temperature signal to the DUT, users need to manually input the value.

5. Finish the task

Refer to Finish the task in paragraph 6.1.1.5.

6.2.2 Temperature transmitter

This type of task is for calibrating temperature transmitter without sensor. It will use the calibrator's simulate temperature output as the sensor.

1. Connect to DUT

- ◆ Connect the DUT with the measurement and output module of the calibrator, as shown in the Figure 18.

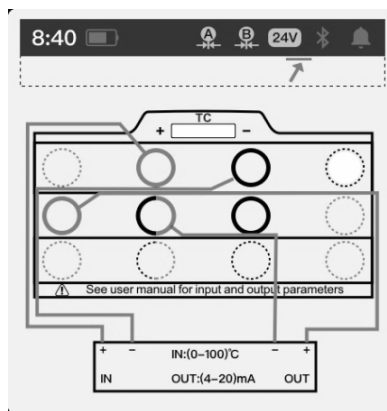

Figure 18 Temperature transmitter

2. Create the task

Create the corresponding DUT tasks as described above, and fulfill the necessary information. See Table 28.

Table 27 Temperature transmitter task setting

Subject	Valid value	Description
Name	Numbers, letters, symbols	Task name
S/N	Numbers, letters, symbols	Task S/N
Model	Numbers, letters, symbols	Model of DUT
Input	Numbers	Input range of DUT
Sensor	TCs or RTDs optional	Sensor type of the DUT
Output	Analog signal: 4~20mA,0~10mA,0~20mA,1~5V,0~5V,0~10V,custom	Output range of DUT
	HART devices: Process variables, percentage, Output current, loop current	
Accuracy	0.06%,0.1%,0.16%,0.25%,0.4%, 0.6%,1%,1.6%,2.5%,4%, custom	Accuracy of DUT, the input is customizable
Transfer function	Linear / square / square root	Transfer function of the DUT signal
Owner	Numbers, letters, symbols	Owner of DUT
Location	Numbers, letters, symbols	Location of DUT
Note	Numbers, letters, symbols	Additional information



3. Task setting

Refer to the task setting in paragraph 6.1.1.1.

4. Start the task

- ◆ For part of the content, refer to Start the task in paragraph 6.1.1.4.
- ◆ During the task performing, the calibrator simulates and outputs a temperature signal to the DUT, measures and records the electrical signal output of the DUT. No manually input required.

5. Finish the task

Refer to Finish the task in paragraph 6.1.1.5.

6.2.3 Temperature transmitter with sensor

This type of task is for calibrating temperature transmitter with sensor. During calibration, it requires to put the DUT into a temperature source (such as ADT875/878 dry well or thermostatic bath). At the same time, use a reference sensor to connect to the TC/RTD measurement ports on the calibrator, as shown in Figure 19.

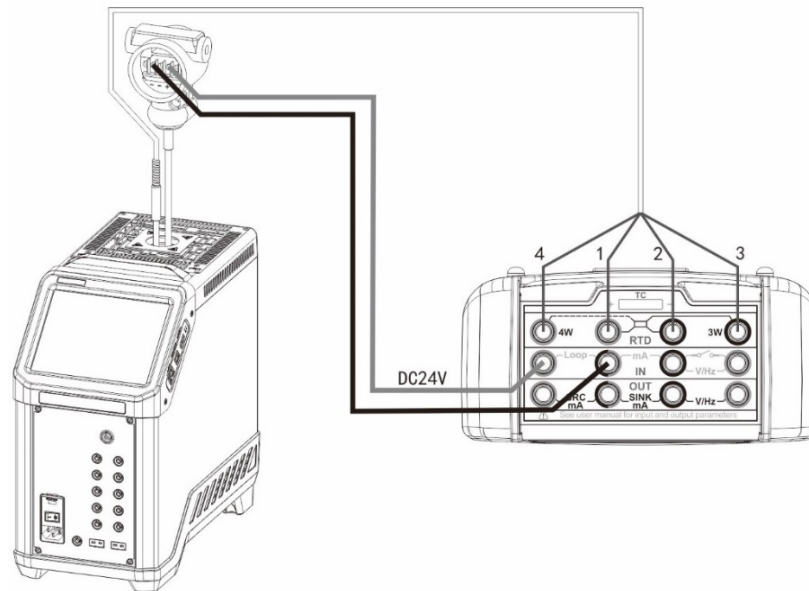

Figure 19 Temperature transmitter with sensor

1. Connect to DUT

- ◆ According to the Figure 8 or 9 and the type of reference sensor, to measure the TC or RTD. Then according to Figure 6 or 7 to measure the voltage or circuit based on the transmitter's output type.

2. Create the task

Refer to paragraph 6.2.2.

3. Task setting

Refer to the task setting in paragraph 6.1.1.1.

4. Start the task

- ◆ For part of the content, refer to Start the task in paragraph 6.1.1.4.
- ◆ During the task performing, the calibrator simulates and outputs a temperature signal to the DUT, measures and records the electrical signal output of the DUT. No manually input required.

5. Finish the task

Refer to Finish the task in paragraph 6.1.1.5.

6.2.4 Temperature switch

This type of task is for calibrating temperature switch without sensor. It will use the calibrator's simulate temperature output as the sensor.

1. Connect to DUT

- ◆ Connect the DUT with the measurement and output module of the calibrator, as shown in the Figure 20.

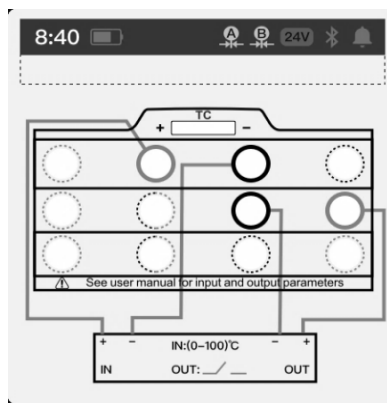

Figure 20 Temperature switch

2. Create the task

Create the corresponding DUT tasks as described above, and fulfill the necessary information. See Table 29.

Table 28 Temperature switch task setting

Subject	Valid value	Description
Name	Numbers, letters, symbols	Task name
S/N	Numbers, letters, symbols	Task S/N
Model	Numbers, letters, symbols	Model of DUT
Range	Numbers	Input range of DUT



Sensor	TCs or RTDs optional	DUT sensor type
Accuracy	0.06%,0.1%,0.16%,0.25%,0.4%, 0.6%,1%,1.6%,2.5%,4%,custom	Accuracy of DUT, the input is customizable
Set point	Numbers	Action set point of DUT
Set action type	Opened/ closed	Action type of DUT
Dead band	Numbers	Dead band range of the DUT
Owner	Numbers, letters, symbols	Owner of DUT
Location	Numbers, letters, symbols	Location of DUT
Note	Numbers, letters, symbols	Additional information

3. Task setting

Refer to the task setting in paragraph 6.1.1.3.

4. Start the task

- ◆ For part of the content, refer to Start the task in paragraph 6.1.1.4.
- ◆ When the DUT moves (opened/closed) during the task, the calibrator will automatically record the temperature output at the moment of the action, no manually input required.

5. Finish the task

Refer to Finish the task in paragraph 6.1.1.5.

6.2.5 Temperature switch with sensor

This type of task is for calibrating temperature switch with sensor. During calibration, it requires to put the DUT into a temperature source (such as ADT875/878 dry well or thermostatic bath, as shown in Figure 21).

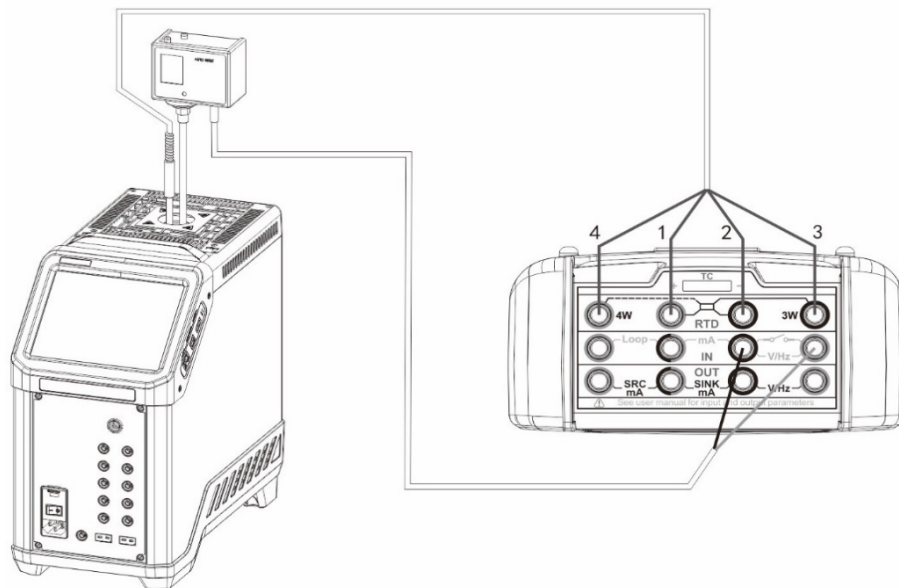

Figure 21 Temperature switch with sensor

1. Connect to DUT

-
- ◆ According to the Figure 8 or 9 and the type of reference sensor, to measure the TC or RTD. Then according to Figure 6 to measure the switch signal.
 - 2. Create the task
Refer to paragraph 6.2.4.
 - 3. Task setting
Refer to the task setting in paragraph 6.1.1.1.
 - 4. Start the task
 - ◆ For part of the content, refer to Start the task in paragraph 6.1.1.4.
 - ◆ When the DUT moves (open/close) during the task, the calibrator will automatically record the temperature value at the moment of the action, without manually input.
 - 5. Finish the task
Refer to Finish the task in paragraph 6.1.1.5.

6.3 Calibrate flow devices

6.3.1 Delta- pressure flowmeter

1. Connect DUT
 - ◆ Connect the external pressure module to the module Lemo type connection A or B.
 - ◆ Connect DUT output with the electrical module of the calibrator according to the signal type of DUT output (current/ voltage), as shown in the Figure 6 or 7.
2. Create the task
Create the corresponding DUT tasks as described above, and fulfill the necessary information. See Table 30.

Table 29 Delta-pressure flowmeter task setting

Subject	Valid value	Description
Name	Numbers, letters, symbols	Task name
S/N	Numbers, letters, symbols	Task S/N
Model	Numbers, letters, symbols	Model of DUT
Input	Numbers	Input range of DUT
Output	Numbers	Output range of DUT, switch the unit to change the input signal type (current/ voltage)
Accuracy	0.06%,0.1%,0.16%,0.25%,0.4%, 0.6%,1%,1.6%,2.5%,4%,custom	Accuracy of DUT, the output is customizable
Transfer function	Linear / square / square root	Transfer function of the DUT signal
Owner	Numbers, letters, symbols	Owner of DUT
Location	Numbers, letters, symbols	Location of DUT
Note	Numbers, letters, symbols	Additional information

3. Task setting

Refer to the task setting in paragraph 6.1.1.3.

4. Start the task

- ◆ For part of the content, refer to Start the task in paragraph 6.1.1.4.
- ◆ The calibrator will automatically use the measured value of the voltage or current gear position according to the DUT output type set by the user, no manually input required.



5. Finish the task

Refer to Finish the task in paragraph 6.1.1.5.

6.3.2 Instantaneous flowmeter

1. Connect to DUT

- ◆ According to the type of the DUT, connect the DUT input with the current output (Figure 14), voltage/ frequency output (Figure 13) of the calibrator's electrical output module.

2. Create the task

Create the corresponding DUT tasks as described above, and fulfill the necessary information. See Table 31.

Table 30 Instantaneous flowmeter task setting

Subject	Valid value	Description
Name	Numbers, letters, symbols	Task name
S/N	Numbers, letters, symbols	Task S/N
Model	Numbers, letters, symbols	Model of DUT
Input	Numbers	Input range of DUT, switch the unit to change the input signal type (current/ voltage/ frequency)
Output	Numbers	Output range of DUT, variety of flow units available
Decimals	Option 0~3	The last decimal digit of the DUT's display
Accuracy	0.06%,0.1%,0.16%,0.25%,0.4%, 0.6%,1%,1.6%,2.5%,4%,custom	Accuracy of DUT, the output is customizable
Transfer function	Linear / square / square root	Transfer function of the DUT signal



Owner	Numbers, letters, symbols	Owner of DUT
Location	Numbers, letters, symbols	Location of DUT
Note	Numbers, letters, symbols	Additional information

3. Task setting

Refer to the task setting in paragraph 6.1.1.3.

4. Start the task

- ◆ For part of the content, refer to Start the task in paragraph 6.1.1.4.
- ◆ The calibrator will automatically use the voltage and current output gears to output electrical signals to the DUT according to the type of DUT input set by the users, and the users need to manually input the value of each set point.

5. Finish the task

Refer to Finish the task in paragraph 6.1.1.5.

6.3.3 Flow volume totalizers

1. Connect to DUT

- ◆ Connect the DUT input with the frequency output module of the calibrator, as shown in the Figure 14.

2. Create the task

Create the corresponding DUT tasks as described above, and fulfill the necessary information. See Table 32.



Table 31 Flow volume totalizers task setting

Subject	Valid value	Description
Name	Numbers, letters, symbols	Task name
S/N	Numbers, letters, symbols	Task S/N
Model	Numbers, letters, symbols	Model of DUT
Frequency	Numbers	Frequency of DUT input signal
Amplitude	Numbers	Amplitude of DUT input signal
Flow unit	Option	Flow unit of DUT, variety of flow units available
Decimals	Option 0~3	The last decimal digit of the DUT's display
Total flow	Numbers	Expected total flow when the task finish
K-Param	Numbers	K coefficient of DUT (The flow rate represented by each signal pulse)
Tolerance	Numbers	Tolerance of DUT
Owner	Numbers, letters, symbols	Owner of DUT
Location	Numbers, letters, symbols	Location of DUT
Note	Numbers, letters, symbols	Additional information

3. Task setting

Refer to the task setting in paragraph 6.1.1.1.

4. Start the task

- ◆ For part of the content, refer to Start the task in paragraph 6.1.1.4.

- ◆ The calibrator will automatically generate a continuous pulse output according to user's settings. After all pulse are output, users will need to enter the current accumulative flow value of the DUT into the calibrator.
- ◆ Repeat the above steps until all task cycles finish.

5. Finish the task

Refer to Finish the task in paragraph 6.1.1.5.

6.3.4 Tachometer/ vortex meters

1. Connect to DUT

- ◆ According to the output signal type of DUT, connect the DUT output with the current measurement (Figure 7) or voltage/ frequency measurement (Figure 6) of the calibrator.

2. Create the task

Create the corresponding DUT tasks as described above, and fulfill the necessary information. See Table 33.

Table 32 Tachometer task setting

Subject	Valid value	Description
Name	Numbers, letters, symbols	Task name
S/N	Numbers, letters, symbols	Task S/N
Model	Numbers, letters, symbols	Model of DUT
Input	Numbers	Input range of DUT, variety of flow units available
Output	Numbers	Output range of DUT, switch the unit to change the output signal type (current/ voltage/ frequency)
Decimal digits	Option 0-3	The last decimal digit of the DUT's display



Accuracy	0.06%,0.1%,0.16%,0.25%,0.4%, 0.6%,1%,1.6%,2.5%,4%,custom	Accuracy of DUT, the output is customizable
Transfer function	Linear / square / square root	Transfer function of the DUT signal
Owner	Numbers, letters, symbols	Owner of DUT
Location	Numbers, letters, symbols	Location of DUT
Note	Numbers, letters, symbols	Additional information

3. Task setting

Refer to the task setting in paragraph 6.1.1.3.

4. Start the task

- ◆ For part of the content, refer to Start the task in paragraph 6.1.1.4.
- ◆ The calibrator will automatically record the measured signal value at the moment, the current display of DUT needs to be input manually.

5. Finish the task

Refer to Finish the task in paragraph 6.1.1.5.

6.4 Calibrate loop devices

6.4.1 Loop indicators

1. Connect to DUT

- ◆ Connect the DUT input with the electrical output module of the calibrator, as shown in the Figure 14(for current output) or 13(for voltage output).

2. Create the task

Create the corresponding DUT tasks as described above, and fulfill the necessary information. See Table 34.

Table 33 Loop readout task setting

Subject	Valid value	Description
Name	Numbers, letters, symbols	Task name
S/N	Numbers, letters, symbols	Task S/N
Model	Numbers, letters, symbols	Model of DUT
Range	(4~20)mA,(0~10)mA,(0~20)mA,(1~5)V,(0~5)V,(0~10)V, custom	Input range of DUT
Accuracy	0.025%,0.05%,0.1%,0.16%,0.25%,0.4%,1%,1.6%,2.5%,4%,custom	Accuracy of DUT
Owner	Numbers, letters, symbols	Owner of DUT
Location	Numbers, letters, symbols	Location of DUT
Note	Numbers, letters, symbols	Additional information

3. Task setting

Refer to the task setting in paragraph 6.1.1.1.

4. Start the task

- ◆ For part of the content, refer to Start the task in paragraph 6.1.1.4.
- ◆ During the task performing, the calibrator will output the corresponding electrical signal according to the set point and the DUT input type (current/voltage) set by the user. For the measured value at each set point, users need to manually input them.

5. Finish the task

Refer to Finish the task in paragraph 6.1.1.5.



6.4.2 Loop signal source

1. Connect to DUT

- ◆ Connect the DUT with the measurement module of the calibrator, as shown in the figure 7 (for current measurement) or 6 (for voltage measurement).

2. Create the task

Create the corresponding DUT tasks as described above, and fulfill the necessary information. See Table 35.

Table 34 Loop signal source task setting

Subject	Valid value	Description
Name	Numbers, letters, symbols	Task name
S/N	Numbers, letters, symbols	Task S/N
Model	Numbers, letters, symbols	Model of DUT
Range	(4~20)mA,(0~10)mA,(0~20)mA,(1~5)V,(0~5)V,(0~10)V, custom	Output range of DUT
Accuracy	0.025%,0.05%,0.1%,0.16%,0.25%,0.4%,1%,1.6%,2.5%,4%,custom	Accuracy of DUT
Transfer function	Linear / square / square root	Transfer function of the DUT
Owner	Numbers, letters, symbols	Owner of DUT
Location	Numbers, letters, symbols	Location of DUT
Note	Numbers, letters, symbols	Additional information

3. Task setting

Refer to the task setting in paragraph 6.1.1.

4. Start the task

- ◆ For part of the content, refer to Start the task in paragraph 6.1.1.4.
- ◆ During the task performing, the calibrator will output electrical signals according to the set point and measure the DUT output signal, no manually input required during the process.

5. Finish the task

Refer to Finish the task in paragraph 6.1.1.5.

6.4.3 Signal isolator/ converters

1. Connect to DUT

- ◆ Connect the DUT input with the output module of the calibrator, as shown in the figure 14 (for current output) or 13 (for voltage output). Connect the DUT output with the electrical measurement module of the calibrator according to the DUT signal type, as shown in figure 7(Current Measurement) and figure 6(Voltage Measurement).

2. Create the task

Create the corresponding DUT tasks as described above, and fulfill the necessary information. See Table 26

Table 35 Signal isolator task setting

Subject	Valid value	Description
Name	Numbers, letters, symbols	Task name
S/N	Numbers, letters, symbols	Task S/N
Model	Numbers, letters, symbols	Model of DUT
Input	(4~20)mA,(0~10)mA,(0~20)mA,(1~5)V,(0~5)V,(0~10)V, custom	Input range of DUT
Output	(4~20)mA,(0~10)mA,(0~20)mA,(1~5)V,(0~5)V,(0~10)V, custom	Output range of DUT



Accuracy	0.05%,0.1%,0.2%,0.5%,1%,1.5%,2%,2.5%,custom	Accuracy of DUT
Transfer function	Linear / square / square root	Transfer function of the DUT
Owner	Numbers, letters, symbols	Owner of DUT
Location	Numbers, letters, symbols	Location of DUT
Note	Numbers, letters, symbols	Additional information

3. Task setting

Refer to the task setting in paragraph 6.1.1.4.

4. Start the task

- ◆ For part of the content, refer to Start the task in paragraph 6.1.1.4.
- ◆ During the task performing, users need to manually control the electrical signal corresponding to the DUT output according to the set point, and input the reading of the DUT electrical signal into the calibrator, the calibrator will give the task result according to the measured value and entered reading as well as the accuracy analysis set by users.

5. Finish the task

Refer to Finish the task in paragraph 6.1.1.5.

6.4.4 Limit Switches

1. Connect to DUT

- ◆ Connect the DUT input with the output module of the calibrator, as shown in the figure 14 (for current output) or 13 (for voltage output).
- ◆ Connect the DUT output with the electrical module of the calibrator, as shown in Figure 6.

2. Create the task

Create the corresponding DUT tasks as described above, and fulfill the necessary information.

Table 36 Limit switches task setting

Subject	Valid value	Description
Name	Numbers, letters, symbols	Task name
S/N	Numbers, letters, symbols	Task S/N
Model	Numbers, letters, symbols	Model of DUT
Range	(4~20)mA,(0~10)mA,(0~20)mA,(1~5)V,(0~5)V,(0~10)V, custom	Input range of DUT
Accuracy	0.5%,1%,1.5%,2%,2.5%,custom	Accuracy of DUT
Set point	Numbers	Action set point of DUT
Set action type	Open/ closed	Action type of DUT
Dead band	Numbers	Switch difference range of the DUT(dead band)
Owner	Numbers, letters, symbols	Owner of DUT
Location	Numbers, letters, symbols	Location of DUT
Note	Numbers, letters, symbols	Additional information

3. Task setting

Refer to the task setting in paragraph 6.1.1.3.

4. Start the task



-
- ◆ For part of the content, refer to Start the task in paragraph 6.1.1.4.
 - ◆ When the DUT acts (open/close) during the task performing, the calibrator will automatically record the electrical signal value at the moment of the action, no manually input required.

5. Finish the task

Refer to Finish the task in paragraph 6.1.1.5.

7.Applications

7.1 Pressure Unit Converter

Click on the right top of the main interface, select Application and enter the pressure unit converter.

It supports switching between different units.

7.2 Leak Test

In the Leak test function, connect the pressure gauge and the calibrator in a gas circuit, then perform leak test to check for the leakage. Click the blank area in the leak test page to enter the settings, see Table 38.

Table 37 Leak test setting

Subject	Valid value	Description
Pressure type	Gauge/ absolute	Pressure type of DUT, see the calibrator model
Unit	Pressure unit	Pressure unit of DUT
Wait time	Numbers	Set the waiting time before testing
Test time	Numbers	Set the time for leak test
Rate unit	Second/ minute	Unit displayed

7.2.1 Leak Test Performing

1. Connect to gas circuit
 - a. Connect the device to the gas circuit;
 - b. Click the start icon at the bottom of the screen, apply pressure to the leak test point;



- c. Start counting down the waiting time, and record the real-time pressure at the end of the waiting time as the initial pressure;
 - d. Start the test, count down the test time, and start to calculate the real-time leakage, $\text{real-time leakage} = \text{initial pressure} - \text{real-time pressure}$;
 - e. Record the pressure at the end of the test time as the end pressure;
 - f. The entire leak detection process ends, and the final leakage = initial pressure - end pressure;
2. The whole process will be displayed in stages in the leak curve at the bottom of the screen.

7.3 PSV test

The PSV test is used for testing the opening pressure of the safety valve. In order to ensure the accuracy of the test, after starting the test, the pressure gauge/calibrator will automatically read the data with a high-speed of 10 times per second and continuously record the real-time pressure data. It will calculate the maximum pressure, and draw the real-time pressure curve to visually show the trend of the pressure. Click on the start button in bottom area of the PSV test page to enter the setup, as shown in Table 39.

Table 38 PSV test setting

Subject	Valid value	Description
Pressure type	Gauge/ absolute	Pressure type of DUT, see the calibrator model
Unit	Different modules support different pressure units	Select corresponding pressure unit

7.3.1 PSV test performing

1. Connect air circuit
 - a. Connect the device to the air circuit;
 - b. Press the Start icon on the right of the screen to start performing, apply the pressure gradually to the safety valve;

-
- c. Count down the test time and record the real-time pressure value and create the pressure curve, then record the maximum pressure during the process;
 - d. Count down complete, the entire leak test process finishes, save the data;
2. The whole process will be shown in the leak test curve at the bottom of the screen

7.4 Thermal calculator

The calibrator provides thermal calculator app, dedicated to variety of industrial TC, RTD and customized type of sensor. By using the thermal calculator, it is convenient for converting between temperature and electrical signals of different sensors.

7.5 Sensor library

In order to meet the needs of custom sensor types, the calibrator provides a sensor library function. In the sensor library function, users can define new sensor types according to their needs and set relevant parameters in the sensor.

The sensor library supports a total of four types of custom sensors: ITS-90, CVD, RTD and TC.

7.6 Simulate transmitter

The calibrator provides simulate transmitter function, which can easily use the calibrator as a transmitter. Click the simulate transmitter icon  on the main interface to enter the simulate transmitter function. Before using this function, you should set the transmitter function in the setting menu. The detail is shown in Table 40.



Table 39 Simulate transmitter settings

Subject	Valid value	Description
Type of transmitter	Pressure transmitter/TC-temperature transmitter/RTD- temperature transmitter / signal convertor	Select transmitter type
Initial range	Value(the unit depends on the transmitter type)	Transmitter input range
Resolution	4/ 5/ 6	Transmitter resolution
Scaled range	value(select frequency, voltage or current as unit)	Transmitter output range
Transfer function	linear/ square/ root	Transfer function
Sensor type	Type of the sensor	Available for RTD& temperature simulate transmitter)
Sensor CJC type	Auto/ fixed	Available for simulate transmitter
CJC value	-80~300	Available for TC simulate transmitter)
Wires	2/3/4	Available for RTD-simulate transmitter)

After the setting is completed, click the confirm button, and the calibrator will generate the corresponding output signal for the measured input signal based on the set transmission method. The measured signal and the converted output signal are displayed in the upper and lower channels.

7.7 Data logger

The calibrator provides the function of multi-channel long-term data logging and analysis. Click the "data logger" application icon in the main operation interface to enter. In order to better protect data security, data logging provide a

power-off save function. When the shutdown occurs during the recording operation, the data logging will automatically save the data recorded before the shutdown. When the power is turned on and enter the data logger management interface again, the calibrator will prompt that there are unsaved records that need to be saved.

7.7.1 Logger Management

In the data logging management interface displayed after the application of "data logging", the completed log files displayed on the management interface are arranged in reverse order by date and time. At the bottom, there is the entry for delete and new record functions.

7.7.2 The start of data logging

Starting a new data record by clicking the new record icon at the bottom of the logging management interface. Before starting, please follow the steps below to configure:

1. Logging channel configuration

In the channel configuration interface, you can add or delete the logging channels, click on the added channel to enter the current channel detailed configuration interface, and further set the channel's measurement projects, units, filter and other information. For specific channel settings, please refer to the chapter "Calibrator", it introduced the function operation of each signal measurement. The channel display color setting is also provided in the channel configuration interface. Appropriate color matching can make the channel data more clearly displayed in the recording operation. After the channel configuration is completed, click the start button at the bottom to continue the configuration of the running parameters

2. Sampling configuration

The sampling configuration of data logging is shown in Table 41. Click the start icon, edit the sampling settings and click the start button at the bottom to start the data logging operation.



Table 40 Data logging parameter setting table

Project	Effective value	Description
Interval	0.5~100	To record the data interval time. Unit: second
Samples	2~1000000	Number of data
Time	Hour: minute: second	Data logging time

7.7.3 The operation of data logging

For more intuitive display and convenient operation, the record operation interface is divided into three functional areas: data logging curve display area, channel information display area (or data logging operation area) and record operation information display area.

1. Data record curve display area

- ◆ The abscissa is the time, which will be automatically adjusted according to the time of the logging operation
- ◆ The ordinate is the data, which will be automatically adjusted according to the range of recorded data values.
When the curve shows only one channel, only the left vertical axis is displayed, and the axis scale is the engineering unit of the corresponding channel;
When the curve shows only two channels, the left and right vertical axes are displayed at the same time, and the axis scale is the engineering unit of the corresponding channel;
When the curve display has three or more channels, only the left vertical axis is displayed, and the axis scale is percentage. The real-time data of each channel is converted into percentage data according to the recorded minimum and maximum values for curve display.
- ◆ Click on the curve area to switch the channel information display area to the data logging operation display area;

2. Channel information display area

-
- ◆ Display the real-time data and statistical information of each logging channel (maximum, minimum, average, peak and standard deviation)
 - ◆ Click on the channel to control the display or hiding of the channel in the curve. If the channel is set to hide, the display color of the channel data text will change to white (using dark theme);
 - ◆ The display area can only show up to two channels at the same time. When the number of channels exceeds two, you can switch to other channel display by sliding left and right:

3. Record operation information display area

Click the data record curve display area to open the record data operation display area. The recorded data operation display is divided into three modes: eye pattern mode (default), analysis mode, and following mode.

- ◆ Eye pattern mode:

The eye pattern mode is the normal data operation mode, and its data curve is drawn by the data of the whole period of operation.

- ◆ Analysis mode:

The analysis mode mainly analyzes the data of certain period time on the curve in the data logging and view the statistical information of the corresponding channel (view through the channel information display area). In the analysis mode, you can operate the operable buttons in the logging data display area (Move left/right, zoom in/out, full record time, window time) to move the curve, and then operating the data segment selection axis operation buttons (X1, X2) to select the data area to analyze and click the return button to view data statistics of each channel.

- ◆ Following Mode:

The following mode is based on the time width of the current window, when the curve runs to the end of the curve frame, the start time in the data image will automatically change, so that the image curve can show the latest running status. You can adjust the width of the display time axis to display the curve in data logging operation area.



-
- 4. Record operation information display area
 - ◆ Showing the record progress and record countdown;
 - ◆ Click the stop button to stop the recording operation;

7.7.4 Save the data

When the data logging is completed or manually terminated, the calibrator will automatically display the record save interface, and the record name and operator information need to be entered in the save interface.

7.8 Differential pressure

The calibrator provides differential pressure module composite application. The user can connect two same range external digital pressure modules, and composite a new differential pressure module through the differential pressure module function software processing in order to provide differential pressure accurate measurement under high static pressure. Click the differential pressure icon on the main screen of the device  to enter the differential pressure interface. The detailed settings of the differential pressure module are shown in table 42.

Table 41 The settings of the differential pressure module

Project	Effective value	Description
Enable	Enable /disable switch	Enable or disable the differential pressure module. When the differential pressure module is enabled, the differential pressure module channels will be displayed in the related functions channel list.
Resolution	4/5/6	The resolution of differential pressure
Range	Numbers	Differential module measuring range



Calculate type	A-B or B-A	For the composite mode of differential pressure module, A and B represent external pressure module A and external pressure module B respectively
Real time data	Real time differential pressure value	The real-time differential pressure value is displayed only when the differential pressure module is enabled and both external pressure modules A and B are online. Otherwise, the real-time differential pressure value is displayed as -----
Zero offset	zero offset when zeroing	Zero offset when differential pressure module zeroing
External module A	Module real time pressure values and units	Click to enter to view the module information
External module B	Module real time pressure values and units	Click to enter to view the module information

8. HART Communicator







The calibrator provides a full HART communicator function, using the native HART DD file. The calibrator can be used to complete the maintenance and commissioning of almost all HART temperature and pressure device, including parameter modification, fault diagnosis, and daily maintenance and calibration, etc. Concerning that the operation of the communicator on the HART device depends on the DD file, the operation varies a lot between different HART devices, so please refer to the manual of the HART device before using the function.

Note: The calibrator always acts as the master station during the communication with the HART device. Therefore, in order to avoid harm to the control system, the HART device must be separated from the control system before using the calibrator to connect to the HART device.

8.1 HART connection and search

Please refer to Paragraph 3.4.1.

8.2 HART communicator operation

1. Read the parameters in HART and modify them, the root directory shows items 1~4, depends on the HART device,
2. The parameters that have been modified but not written into HART are highlighted in yellow in the list, click  to complete the writing to HART; For some of the parameter, enter the page and click  at the bottom to view the instruction information.
3. Click the  and  at the bottom of the screen to view respectively the communicate status and device status. Enter it and the vacant circle on the right of the list indicates that it is normal, otherwise it means that the item is abnormal.
4. Click on  at the right of the screen to return to the main interface of the device, and click  at the right top of the screen to return to HART communicator again.