

# MATRICE 200 SERIES V2

## M210 V2 / M210 RTK V2

User Manual v1.2

2019.04

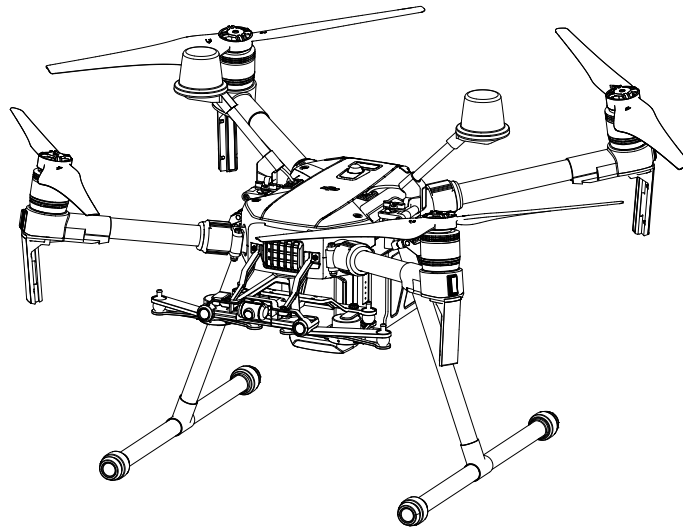

### Searching for Keywords

Search for keywords such as "battery" and "install" to find a topic. If you are using Adobe Acrobat Reader to read this document, press Ctrl+F on Windows or Command+F on Mac to begin a search.

### Navigating to a Topic





View a complete list of topics in the table of contents. Click on a topic to navigate to that section.

### Printing this Document

This document supports high resolution printing.

## Using This Manual

### Legends

 Warning     Important     Hints and Tips     Reference

### Before Flight

The following materials have been produced to help users make full use of the MATRICE™ 210 V2 / Matrice 210 RTK V2.

1. In the Box
2. Disclaimer and Safety Guidelines
3. Quick Start Guide
4. Intelligent Flight Battery Safety Guidelines
5. User Manual

Watching all the tutorial videos and reading the Disclaimer and Safety Guidelines before flight is recommended. Afterwards, prepare for your first flight by using the Quick Start Guide. Refer to this manual for more comprehensive information.

### Download the DJI Pilot app

The DJI Pilot app is required if using a mobile device connected to the remote controller. Search for Scan the QR code or visit [https://m.dji.net/djipilot\\_enterprise](https://m.dji.net/djipilot_enterprise) to download the app. DJI Pilot supports Android 5.0 or later.



\* For increased safety, the flight is restricted to a height of 30 m and distance of 50 m when not connected or logged into the app during flight, including DJI Pilot and all apps compatible with DJI aircraft.

### Download the DJI Assistant 2 for Matrice

Download and install the ASSISTANT™ 2 for Matrice before use.  
<http://www.dji.com/matrice-200-series-v2/info#downloads>

# Contents

<b>Using This Manual</b>	2
Legends	2
Before Flight	2
Download the DJI Pilot app	2
Download the DJI Assistant 2 for Matrice	2
<b>Product Profile</b>	6
Introduction	6
Feature Highlights	6
Assemble the Aircraft	7
Preparing the Remote Controller	9
Aircraft Diagram	10
Remote Controller Diagram	11
<b>Aircraft</b>	14
Profile	14
Flight Mode	14
Flight Status Indicator	15
Vision System and Infrared Sensing System	16
Return-to-Home (RTH)	20
Center of Gravity Calibration	25
Spotlight Pro	25
Flight Recorder	25
Attaching and Detaching the Propellers	25
DJI Intelligent Flight Battery	26
D-RTK (for M210 RTK V2)	31
DJI AirSense	32
Components at the Rear of the Aircraft	33
<b>Remote Controller</b>	37
Remote Controller Profile	37
Preparing the Remote Controller	37
Mounting the Monitor to the Remote Controller	39
Remote Controller Operations	39
Linking the Remote Controller	45
Mounting the Control Stick Covers	46

<b>Gimbal and Camera</b>	48
Camera	48
Gimbal	49
<b>DJI Pilot App</b>	52
Manual Flight	52
Mission Flight	56
Album	58
DJI FlightHub	58
Menu	58
<b>Flight</b>	60
Flight Environment Requirements	60
GEO (Geospatial Environment Online) System	60
Flight Restrictions	61
GEO Unlocking	64
Preflight Checklist	64
Calibrating the Compass	64
Stop the Motor Mid-flight	66
Starting/Stopping the Motors	66
Flight Test	67
<b>Appendix</b>	70
Specifications	70
Firmware Update	72
Using the Zenmuse XT Gimbal and Camera	73
Dual Downward Gimbals	74
Using the Upward Gimbal and GPS Kit	74
Carrying Box Descriptions	75

## Product Profile

---

This chapter describes the features of the Matrice 210 V2/Matrice 210 RTK V2, shows how to assemble the aircraft, and contains diagrams of the aircraft and remote controller with component explanations.

## Product Profile

### Introduction

The Matrice 210 V2/Matrice 210 RTK V2 (M210 V2/M210 RTK V2) is a powerful aerial imaging system with class-leading agility and speed, redundant components for maximum reliability, and smart features that make performing complex tasks easy. The aircraft's visual sensors\* enable enhanced hovering precision even when flying indoors or in environments where GNSS is unavailable. Gimbal cameras can be easily exchanged to suit your application's needs. Dual frequency transmission system makes HD video downlink more stable and efficient.

\* The Vision and Infrared Sensing Systems are affected by surrounding conditions. Read the related section to learn more.

### Feature Highlights

The flight controller provides a safe and reliable flight experience. A flight recorder stores critical data from each flight. Dual IMUs and barometers design provides redundancy. The aircraft can hover and fly in extremely low altitude and indoor environments, and provides multi-directional obstacle sensing and vision positioning functions.

The built-in AirSense makes you aware of nearby aircraft in the surrounding airspace to ensure safety. The safety beacons on both the top and the bottom of the aircraft allow the aircraft to be identified at night or in low light conditions. The airframe design gives the aircraft an IP43 Ingress Protection, in accordance with the global IEC 60529 standard.

The TimeSync system continuously aligns the flight controller, camera, GPS module, RTK module for the M210 RTK V2, DJI payloads such as X4S, X5S or X7, as well as onboard accessories via the Payload SDK or Onboard SDK at the microsecond level. It meets SDK developers' requirements on time precision.

The low-latency long range (up to 5 mi (8 km), FCC) HD downlink is powered by DJI OCUSYNC™ 2.0. Support of 2.4 GHz and 5.8 GHz ensures a more reliable connection in environments with more interference. The AES-256 encryption keeps your data transmission secure so you can be sure that your critical information stays safe.

An advanced power management system along with dual batteries ensures power supply and enhances flight safety. Without a payload, the M210 RTK V2 has a flight time of up to 33 minutes with standard batteries (TB55), while the M210 V2 has up to 34 minutes of flight time.

The camera unit is now independent from image processor so that you have the flexibility to choose the perfect gimbal and camera system (including ZENMUSE™ X7/X5S/X4S/XT\*/XT2, and Z30) for each of your application. This means that regardless of which camera you choose, you have the same powerful processing backing it. The M210 V2/M210 RTK V2 can support an upward gimbal\*\*, a single downward gimbal (connected to Gimbal Connector I) or dual downward gimbals. It is equipped with many expansion ports to broaden its applications. The M210 RTK V2 has a built-in DJI D-RTK™ 2 air system, which provides more accurate heading data for positioning.\*\*\*

\* The Zenmuse XT Gimbal Adapter is required when mounting the Zenmuse XT gimbal to the aircraft.

\*\* When using an upward gimbal with the M210 V2, an external GPS Kit connected through the expansion port is required.

\*\*\* When using the M210 RTK V2, more accurate positioning data can be achieved when using a DJI D-RTK 2 High Precision GNSS Mobile Station for Matrice Series. If the data transmission signal between the aircraft and the mobile station is weak, it is recommended to use post-processed kinematic (PPK) technology.

## Assemble the Aircraft

This manual uses the M210 RTK V2 and Zenmuse Z30 as an example to demonstrate setup and usage.

### Unfolding the D-RTK Antennas (for M210 RTK V2 only)

Unfold the D-RTK antennas and then turn the knob tightly in the direction indicated by the lock icon .

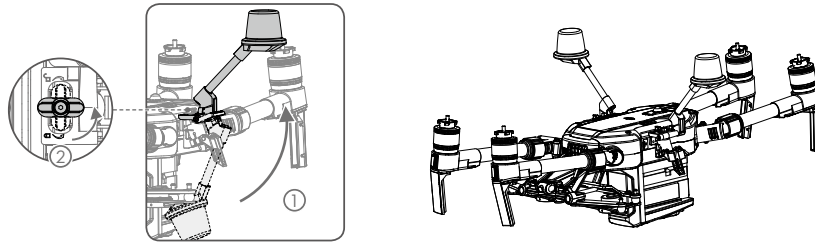

 For the aircraft to take off, the D-RTK antennas must be fully unfolded and securely locked.

### Installing the Landing Gears

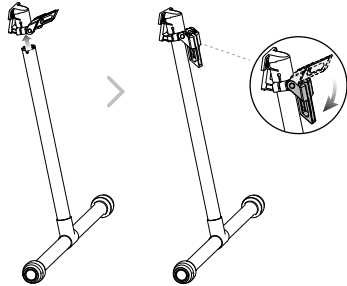

### Unfolding the Aircraft

Unfold the frame arm, slide the arm lock to the end of the frame arm, then rotate it about 90° until the silver line lies within the range of the  icon.

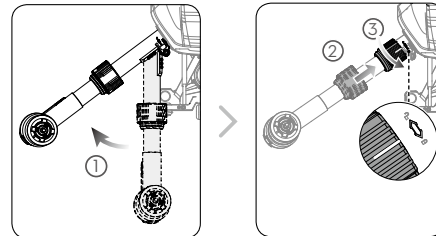

### Mounting the Propellers

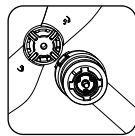

Propellers without silver rings go on motors without any marks.

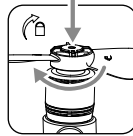

Press the propeller down onto the mounting plate and rotate in the lock direction  until secure.

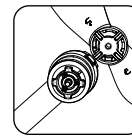

Propellers with silver rings go on motors with the same color marks.

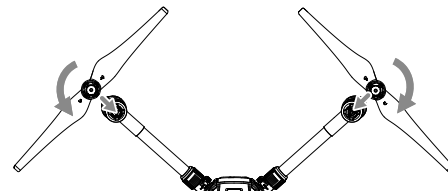

 Check that the propellers are secure before each flight.

### Mounting the Gimbal and Camera

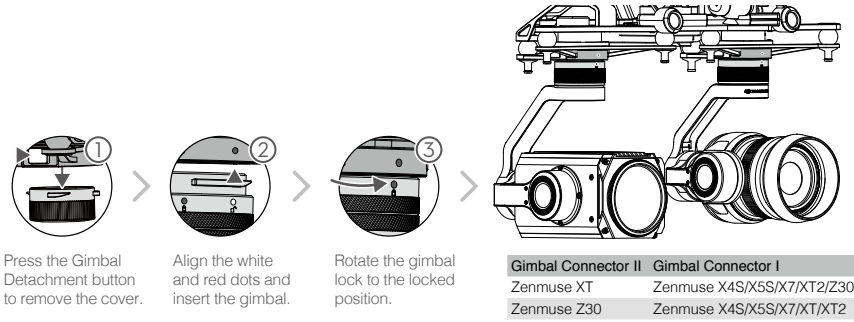

⚠ Make sure to press down the gimbal detachment button when rotating the gimbal lock to remove the gimbal and camera. The gimbal lock should be fully rotated when removing the gimbal for the next installation.

### Mounting the Intelligent Flight Batteries

Insert a pair of batteries.  
 Press once to check the battery level.  
 Press again and hold until the batteries turn on or off.

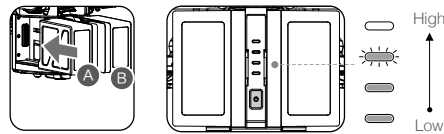

⚠

- Only use battery slot B when using one battery to supply power. In this case, the aircraft can only be powered on, but cannot take off.
- If for any reason only one battery is available during flight, land the aircraft immediately and replace the batteries as soon as possible. In this case, the gimbal connectors and the ports at rear of the aircraft cannot supply power to their connected devices.
- Make sure to use the included TB55 batteries. DO NOT use any other type of batteries.

### Removing the Intelligent Flight Battery

Make sure to press the battery removal button when removing the battery.

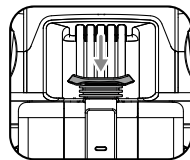

## Preparing the Remote Controller

### Mounting Monitor and Remote Controller Batteries

CRYSTALSKY™ monitors and the remote controller use the same batteries. Put the battery into the Battery Slot, then slide it to the end until you hear a click.

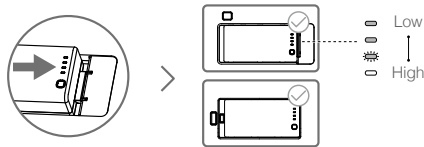

- ⚠ • Press the Battery Release Button before removing the battery.
- Press the Battery Level Button once to check the battery level.

### Mounting the Monitor to the Remote Controller

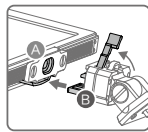

Ensure that Part B is unlocked. Connect Part B to Part A.

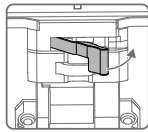

Lock the Mounting Bracket.

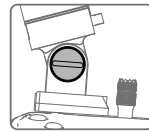

Use a coin or the screwdriver included to adjust the tightness of the tilt axis.

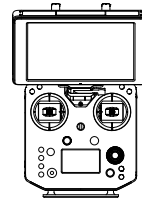

## Aircraft Diagram

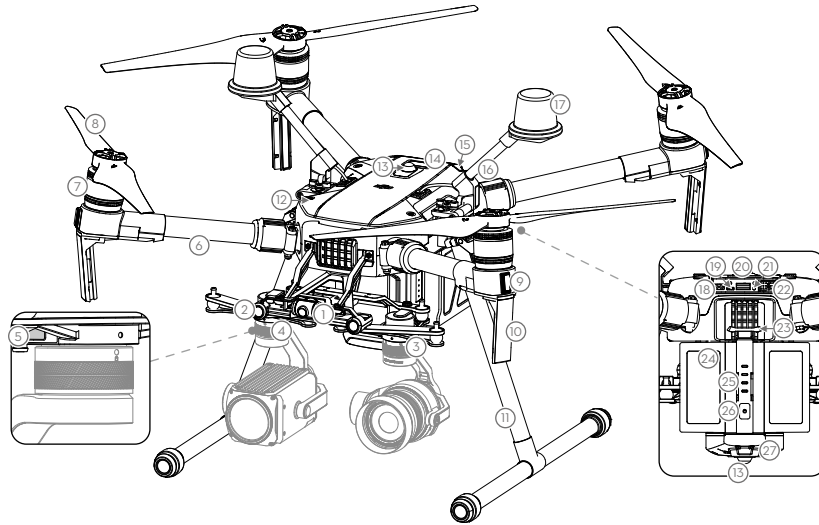

- |  |                                  |
|--|----------------------------------|
| 1. FPV Camera                            | 18. Extended Power Port (XT30)   |
| 2. Forward Vision System                 | 19. USB Mode Switch              |
| 3. DJI Gimbal Connector v2.0 (DGC2.0) I  | 20. USB Port                     |
| 4. DJI Gimbal Connector v2.0 (DGC2.0) II | 21. Linking Button and Indicator |
| 5. Gimbal Detachment Button              | 22. Expansion Ports              |
| 6. Frame Arms                            | 23. Battery Removal Button       |
| 7. Motors                                | 24. Intelligent Flight Batteries |
| 8. Propellers                            | 25. Battery Level Indicators     |
| 9. ESC LEDs                              | 26. Power Button                 |
| 10. Transmission Antennas                | 27. Downward Vision System       |
| 11. Landing Gears                        | 28. microSD Card Slot            |
| 12. Upward Gimbal Mounting Position      |                                  |
| 13. Beacons*                             |                                  |
| 14. Upward Infrared Sensor               |                                  |
| 15. Aircraft Status Indicators           |                                  |
| 16. D-RTK Mounting Bracket**             |                                  |
| 17. D-RTK Antennas**                     |                                  |

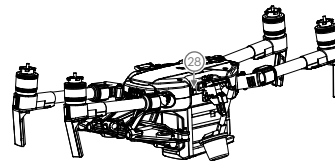

Folded

\* DO NOT look directly at the beacons when they are in use to avoid damage to your eyes.

\*\* Included in the M210 RTK V2 aircraft only.

## Remote Controller Diagram

1. **HDMI Port**  
Output HDMI video signal.
2. **USB Port**  
Supported extended device, e.g. U disk.
3. **microSD Card Slot**  
Provides extra storage space for the display device, maximum card size is 128 GB.
4. **Micro USB Port**  
Use a Micro USB cable to connect to the remote controller when in use, or to the PC to configure parameters via DJI Assistant 2.
5. **Headphone Jack**
6. **Light-Sensitive Port**  
Built-in light-sensitive sensor.
7. **Power Button**
8. **Custom Button (F1)**
9. **Setting Button**
10. **Custom Button (F2)**
11. **Back Button**
12. **Battery Release Button**
13. **WB37 Intelligent Battery**
14. **Antennas**  
Relay aircraft control and video signal.
15. **Monitor Mounting Bracket**  
Used to mount the DJI CrystalSky monitor.
16. **USB Port (Reserved Port)**
17. **Control Sticks**  
Control the orientation and movement of the aircraft.
18. **Strap Hook**
19. **Focus Adjustment Knob**  
Rotate to set the focal length.
20. **Return-to-Home (RTH) Button**  
Press and hold to initiate RTH.
21. **Power Port**  
Connect to the Charger to charge the battery of the remote controller.

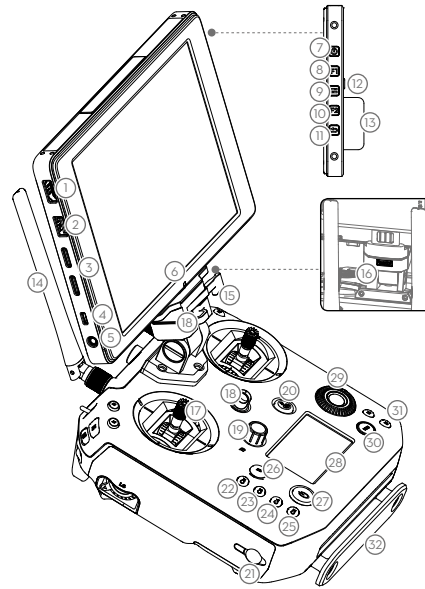

### 22-25. Reserved Buttons

26. **Pause Button**  
Press once and the aircraft will brake and hover.
27. **Power Button**  
Used to turn the remote controller on and off.
28. **Remote Controller Display**  
Shows information about the aircraft and camera.
29. **Camera Setting Dial**  
When using an X4S, X5S, X7 or Z30, turn the dial to adjust the EV. When using an XT2 or XT, turn the dial to select palette.
30. **Customizable Button Settings Menu**  
Press to set Customizable Button functions in the DJI Pilot app.
31. **Customizable Buttons (BA-BH)**  
Customizable through the DJI Pilot app.

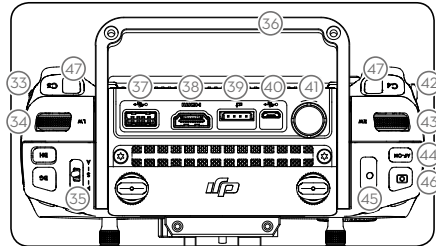

**32. Support Rig**

**33. Left Lever**

Customizable through the DJI Pilot app.

**34. Left Dial (Gimbal Pitch)**

Controls gimbal pitch.

**35. Flight Mode Switch**

Switch between P-mode, S-mode, and A-mode.

**36. Handle Bar**

**37. USB Port (for Mobile Device Connection)**

Connection to mobile device for DJI Pilot app if used a third party mobile device.

**38. HDMI A Port (for Video Output)**

Output HDMI signal to an HDMI monitor.

**39. CAN Bus Port (Extension Port)**

Reserved port used to connect external devices.

**40. Micro USB Port**

Connect to the DJI Assistant 2 for Matrice to update firmware.

**41. SDI Port (for Video Output)\***

Output SDI video signal.

**42. Right Lever**

Customizable through the DJI Pilot app.

**43. Right Dial**

Used to control gimbal pan.

**44. Auto Focus Button**

Press to focus automatically.

**45. Record Button**

Press to start recording video. Press again to stop recording.

**46. Shutter Button**

Press to take a photo. Photos can also be captured during video recording.

**47. Customizable Buttons (C1-C4)**

Customizable through the DJI Pilot app.

\* For better image transmission, a 75Ω coaxial cable is required for SDI video signal output. Make sure to use a coaxial cable with good electromagnetic shielding performance to avoid signal interference which will degrade the flight distance. Additionally, disable the video output in the Image Transmission Settings in the app when the display device is disconnected.

## Aircraft

---

This section describes the features of the Flight Controller, Vision System, and the Intelligent Flight Battery.

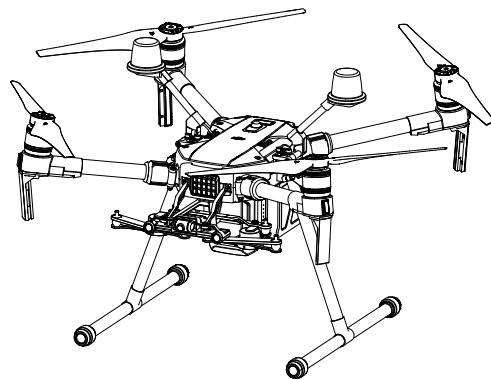

## Aircraft

### Profile

The M210 V2/M210 RTK V2 aircraft includes a flight controller, a communication system, vision systems, a propulsion system and an Intelligent Flight Battery. This section describes the functions of these components.

### Flight Mode

The following flight modes are available for the aircraft:

#### P-mode (Positioning) :

P-mode works best when the GPS signal is strong. The aircraft utilizes the GPS / RTK module (for the M210 RTK V2 only) and Forward and Downward Vision Systems to locate itself, automatically stabilize, and navigate between obstacles.

When the Forward Vision System is enabled and lighting conditions are sufficient, the maximum flight attitude angle is 25°. When forward obstacle sensing is disabled, the maximum flight attitude angle is 30°.

When the GPS signal is weak and lighting conditions are too dark for the Forward and Downward Vision Systems, the aircraft will only use its barometer for positioning to control altitude.

Note: P-mode requires larger stick movements to achieve higher speeds.

#### S-mode (Sport):

The aircraft uses GPS for positioning. As Forward and Downward Vision Systems are disabled, the aircraft will not be able to sense and avoid obstacles when in Sport Mode.

Note: Aircraft responses are optimized for agility and speed making it more responsive to stick movements.

#### A-mode (Attitude):

When neither the GPS nor the Vision Systems are available, the aircraft will only use its barometer for positioning to control the altitude.



• **The Forward Vision System is disabled in S-mode (Sport), which means the aircraft will not be able to automatically avoid obstacles in its flight path. Be vigilant and stay clear of nearby obstacles.**

• The aircraft's maximum speed and braking distance are significantly increased in S-mode (Sport). A minimum braking distance of 164 feet (50 meters) is required in windless conditions.

• The aircraft's responsiveness is significantly increased in S-mode (Sport), which means a small stick movement on the remote controller will translate into a large travel distance of the aircraft. Be vigilant and maintain adequate maneuvering space during flight.



Use the Flight Mode switch on the remote controller to select aircraft flight modes.

---

#### Atti Mode Warning

The aircraft will enter A-mode in the following two instances:

**Passive:** When there is weak GPS signal or when the compass experiences interference where the Vision System is unavailable.

**Active:** Users toggle the flight mode switch to A-mode.

In A-mode, the Vision System and some advanced features are disabled. Therefore, the aircraft cannot position or auto-brake in this mode and is easily affected by its surroundings, which may result in horizontal shifting. Use the remote controller to position the aircraft.

Maneuvering the aircraft in A-mode can be difficult. Before switching the aircraft into A-mode, make sure you are comfortable flying in this mode. DO NOT fly the aircraft too far away as you might lose control and cause a potential hazard.

Avoid flying in areas where GPS signal is weak, or in confined spaces. The aircraft will otherwise be forced to enter A-mode, leading to potential flight hazards, please land it in a safe place as soon as possible.

### Flight Status Indicator

The aircraft features Front LEDs, Rear LEDs, and Aircraft Status Indicators. The positions of these LEDs are shown in the figure below:

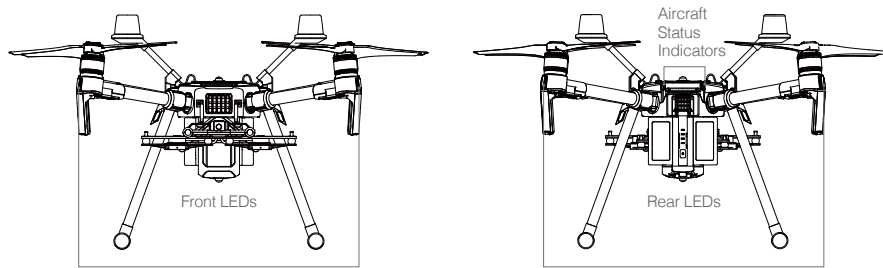







The Front LEDs show the orientation of the aircraft. Front LEDs glow solid red when the aircraft is turned on to indicate the front (or nose) of the aircraft. Front and rear LEDs can be turned off in the DJI Pilot app. The Aircraft Status Indicators communicate the system status of the flight controller. Refer to the table below for more information about the Aircraft Status Indicators. The Front LEDs, Rear LEDs, and Aircraft Status Indicators can be turned off in the DJI Pilot app for unobtrusive drone operations.

### Aircraft Status Indicator Description

Normal		
	Red, green, and yellow flashes	Turning On and Self Diagnostic Testing
	Slow green flashing	P-mode with GPS*
	Two green flashes	P-mode with Forward and Downward Vision Systems*
	Alternating green and blue flashing	The RTK function of the M210 RTK V2 is enabled and RTK data is used.
	Slow yellow flashing	A-mode (no GPS and vision positioning)
	Fast green flashing	Braking automatically after obstacle detected

\* Slow green flashes indicate P-mode, and fast green flashes indicate S-mode.

Warning		
 .....	Fast yellow flashing	Remote Controller Signal Lost
 .....	Slow red flashing	Low Battery Warning
 .....	Fast red flashing	Critical Low Battery Warning
 .....	Red flashing for 5 seconds (when performing CSC)	IMU Error
 —	Solid Red	Critical Error
 .....	Fast alternating red and yellow flashing	Compass Calibration Required
 .....	Alternating red and green flashing	The RTK function of the M210 RTK V2 is enabled but RTK data is unavailable.

### Vision System and Infrared Sensing System

The main components of the Vision System are located on the front and bottom of the aircraft, including [1] [3] stereo vision sensors and [2] two ultrasonic sensors. The Vision System uses ultrasound and image data to help the aircraft maintain its current position, enabling precision hovering indoors or in environments where a GPS signal is not available. The Vision System constantly scans for obstacles, allowing the aircraft to avoid them by going over, going around, or hovering.

The Infrared Sensing System consists [4] of two infrared modules on top of the aircraft. These scan for obstacles on top side of the aircraft and is active in certain flight modes.

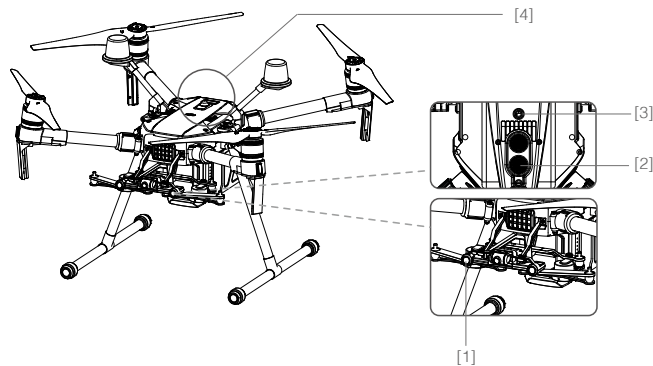

### Detection Range

The detection range of the Vision System is depicted below. Note that the aircraft cannot sense and avoid obstacles that are not within the detection range.

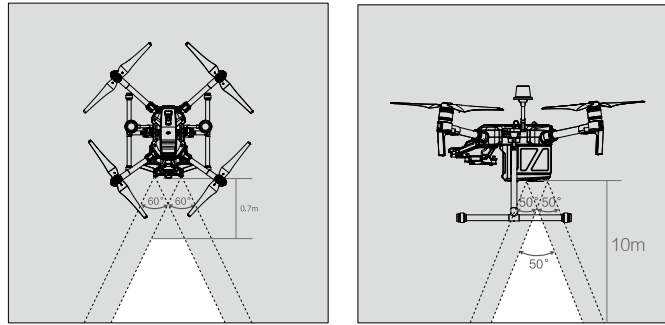

⚠ The aircraft cannot detect objects in low-light conditions. Please fly with caution.

Ultrasonic sensor detection range is depicted below.

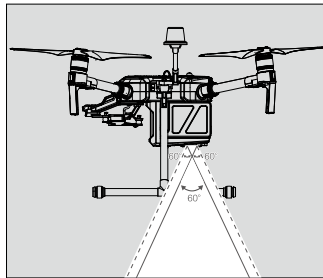

Infrared Sensing System detection range is depicted below.

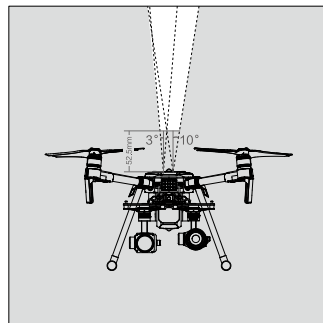

### Calibration

The Vision System cameras installed on the aircraft are factory calibrated. If the aircraft experiences a collision, however, it may require calibration via DJI Assistant 2 for Matrice. Connect the aircraft to a computer and calibrate the Vision System cameras when prompted in DJI Pilot.

1. Power on the Intelligent Flight Battery and slide the USB Mode Switch right.
2. Connect the aircraft and the PC with a USB to USB cable. The USB extension cable included in the package can be used if the USB to USB cable is too short for connection.
3. Launch DJI Assistant 2 for Matrice and log in with a DJI account.
4. Click M200 V2 SERIES and the calibration button.

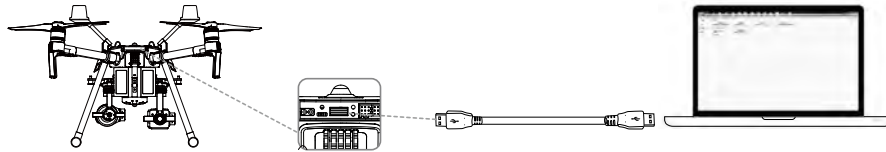

Follow the steps below to calibrate the camera.

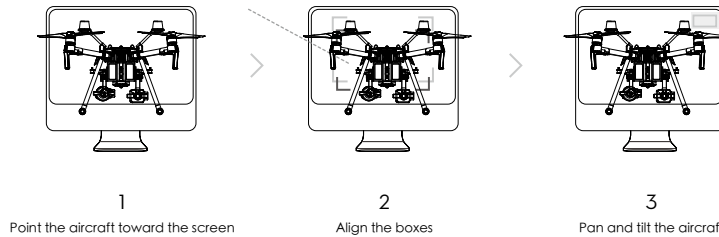

- 
- ⚠ • If using a laptop for calibration, it is recommended to remove the landing gear before calibrating the downward vision system. Otherwise, the rectangle produced by the vision system may not be aligned with the boxes on the screen as the aircraft is farther from the screen.
  - DO NOT power off or unplug the USB cable after calibration. Wait for data calculation.
- 

### Using the Vision System

The Vision System is activated automatically when the aircraft is turned on. No further action is required. The Downward Vision System enables precision hovering indoors or in environments where GPS signal isn't available.

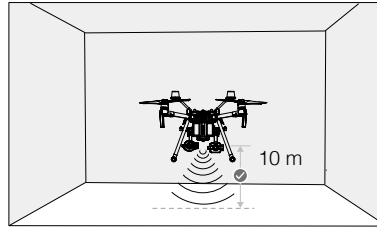

Follow the steps below to use the Downward Vision System:

1. Ensure the aircraft is in P-mode and place the aircraft on a flat surface. Note that the Downward Vision System cannot work properly on surfaces without clear pattern variations.
2. Turn on the aircraft. The aircraft will hover in place after takeoff. The aircraft status indicators will flash green twice, which indicates the Downward Vision System is working.

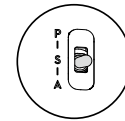

#### Assisted Braking from Obstacle Sensing

Powered by the Forward Vision System, the aircraft is able to actively brake when obstacles are detected in front. Obstacle Sensing works best when lighting is adequate and the obstacle is clearly textured. The aircraft must fly at no more than 34 mph (54 kph) with a maximum pitch angle of 25° to allow for sufficient braking distance.

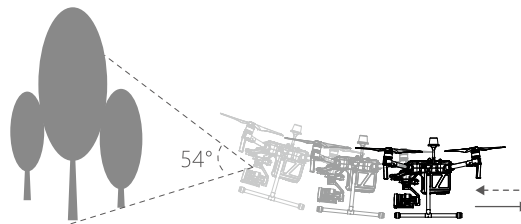

#### Using Infrared Sensing System

The Infrared Sensing System can only be used to avoid large, diffuse, and reflective obstacles (reflectivity >10%). Please be mindful of blind spots (Grey) of the Infrared Sensing System.

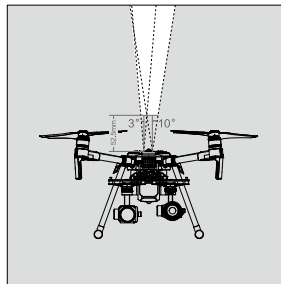



- ⚠ • The performance of your Vision System and Infrared Sensing System is affected by the surface being flown over. Ultrasonic sensors may not be able to accurately measure distances when operating above sound-absorbing materials and the cameras may not function correctly in suboptimal environments. The aircraft will switch from P-mode to A-mode automatically if neither GPS nor Vision System and Infrared Sensing System are available. Operate the aircraft with great caution in the following situations.  
The Vision System will be disabled when:
  - a) Flying over monochrome surfaces (e.g. pure black, pure white, pure red, pure green).
  - b) Flying over highly reflective surfaces.
  - c) Flying over water or transparent surfaces.
  - d) Flying over moving surfaces or objects.
  - e) Flying in an areas where the lighting changes frequently or drastically.
  - f) Flying over extremely dark (lux < 15) or bright (lux > 100,000) surfaces.
  - g) Flying over surfaces without clear patterns or texture.
  - h) Flying over surfaces with identical repeating patterns or textures (e.g. tiling).
  - i) Flying at high speeds of over 31 mph (50 kph) at 2 meters or over 11 mph (18 kph) at 1 meter.
 The Ultrasonic sensors will be disabled when:
  - a) Flying over surfaces that can absorb sound waves (e.g. thick carpet).
  - b) Flying over inclined surfaces that will deflect sound waves away from the aircraft.
 The Infrared be disabled when:
  - a) Flying over obstacles with too small effective infrared reflective surface.
  - b) DO NOT cover the protective glass of the infrared module. Keep it clean and undamaged.

- 💡 • Keep sensors clean at all times. Dirt or other debris may adversely affect their effectiveness.
- Vision System is only effective when the aircraft is at altitudes of 0.3 to 10 meters.
- The Vision System may not function properly when the aircraft is flying over water.
- The Vision System may not be able to recognize pattern on the ground in low light conditions (less than 100 lux).
- Do not use other ultrasonic devices with frequency of 40 KHz when Vision System is in operation.

- 🚫 Keep away from animals while operating the aircraft, as the ultrasonic sensors emit high-frequency sounds which may disturb them.

**Return-to-Home (RTH)**

The Return-to-Home (RTH) function brings the aircraft back to the last recorded Home Point when there is a strong GPS signal. There are three types of RTH: Smart RTH, Low Battery RTH, and Failsafe RTH. This section describes these three RTH types in detail.

	GPS	Description
Home Point		If a strong GPS signal was acquired before takeoff, the Home Point is the location from which the aircraft launched. The GPS signal strength is indicated by the GPS icon  . Less than 4 bars is considered a weak GPS signal. The aircraft status indicator will blink green rapidly when the home point is recorded.

 The aircraft can sense and avoid obstacles when the Forward Vision System is enabled and lighting conditions are sufficient. The aircraft will automatically ascend to avoid obstacles and descend slowly as it returns to the home point. To ensure the aircraft returns home while facing forward, it cannot rotate or fly left and right during RTH while the Forward Vision System is enabled.

### Smart RTH

Use the RTH button on the remote controller and follow the on-screen instructions when GPS is available to initiate Smart RTH. The aircraft will then automatically return to the last recorded Home Point. Use the remote controller to control the aircraft's speed or altitude to avoid a collision during the Smart RTH process. Press and hold the Smart RTH button once to start the process, and press the Smart RTH button again to terminate the procedure and regain full control of the aircraft.

### Low Battery RTH (Can be turned off in DJI Pilot app)

The low battery level failsafe is triggered when the DJI Intelligent Flight Battery is depleted to a point that may affect the safe return of the aircraft. Users are advised to return home or land the aircraft immediately when prompted. The DJI Pilot app will display a notice when a low battery warning is triggered. The aircraft will automatically return to the Home Point if no action is taken after a ten-second countdown. The user can cancel the RTH procedure by pressing the RTH button on the remote controller. The thresholds for these warnings are automatically determined based on the aircraft's current altitude and distance from the Home Point. If the RTH procedure is cancelled following a low battery level warning the Intelligent Flight Battery may not have enough charge for the aircraft to land safely, which may lead to the aircraft crashing or being lost.

The aircraft will land automatically if the current battery level can only support the aircraft long enough to descend from its current altitude. The user cannot cancel the auto landing but can use the remote controller to alter the aircraft's orientation during the landing process.

The Battery Level Indicator is displayed in the DJI Pilot app, and is described below:

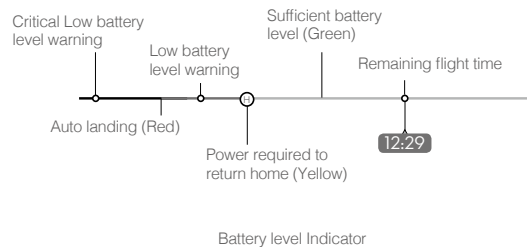

Battery Level Warning	Remark	Aircraft Status Indicator	DJI Pilot App	Flight Instructions
Low battery level warning	Battery power is low. Land the aircraft.	Aircraft status indicator blinks RED slowly.	Tap "Go-home" to have the aircraft return to the Home Point and land automatically, or "Cancel" to resume normal flight. If no action is taken, the aircraft will automatically go home after 10 seconds. Remote controller will sound an alarm.	If RTH is selected, the aircraft will fly back to the Home Point automatically and Landing Protection* will be triggered. Users can regain control during RTH. NOTE: The low battery level warning will not appear again after users regain control.
Critical Low battery level warning	The aircraft must land immediately.	Aircraft status indicator blinks RED quickly.	The DJI Pilot app display will flash red and the aircraft will start to descend. The remote controller will sound an alarm.	Allow the aircraft to descend automatically and trigger Landing Protection*.
Estimated remaining flight time	Estimated remaining time is based on current battery level.	N/A	N/A	N/A

- When the Critical Low battery level warning is triggered and the aircraft begins to land automatically, push the left stick upward to make the aircraft hover at its current altitude, giving you an opportunity to navigate to a more appropriate landing location.
- The colored zones and markers on the battery level indicator bar reflect the estimated remaining flight time. They are automatically adjusted according to the aircraft's current location and status.

### Failsafe RTH

If the Home Point was successfully recorded and the compass is functioning normally, Failsafe RTH will be automatically activated if the remote controller signal is lost for more than three seconds. The aircraft will plan its return route. The user may cancel Failsafe RTH to regain control when connection is reestablished.

### RTH Procedure

1. Home Point is recorded automatically.

\* Make sure that the Landing Protection is enable in the DJI Pilot app.

2. RTH procedure is triggered i.e., Smart RTH, Low-Battery RTH, and Failsafe RTH.
3. Home Point is confirmed and the aircraft adjusts its orientation.
4. a. The aircraft will ascend to the pre-set RTH attitude and then fly to the Home Point when the aircraft is further than 20 m from the Home Point.  
 b. The aircraft will land automatically if RTH is triggered and the aircraft is less than 20 m from the home point.
5. The aircraft will return to the Home Point, and Landing Protection\* will be triggered to allow the aircraft to land or hover in place. Refer to Landing Protection Function (p. 24) for details.

Use the Failsafe RTH for example:

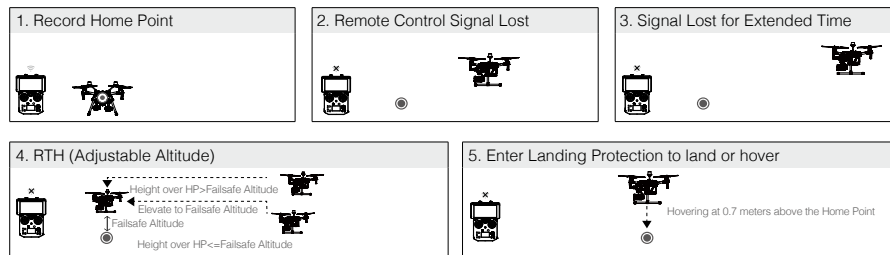

#### Failsafe Safety Notices

	<p>The aircraft cannot avoid obstacles during Failsafe RTH when the Forward Vision System is disabled. Therefore, it is important to set a suitable Failsafe altitude before each flight. Launch the DJI Pilot app, enter Camera and tap  to set the Failsafe Altitude.</p>
	<p>If the aircraft is flying under 65 feet (20 meters) and Failsafe (including Smart RTH, Lower Battery RTH) is triggered, the aircraft will first automatically ascend to 65 feet (20 meters) from the current altitude. You can only cancel the ascending by exiting the Failsafe.</p>
	<p>The aircraft automatically descends and lands if RTH is triggered when the aircraft flies within a 65 foot (20 meter) radius of the Home Point. The aircraft will stop ascending and immediately return to the Home Point if you move the left stick when the aircraft is flying at an altitude of 65 feet (20 meters) or higher and Failsafe is triggered.</p>
	<p>The aircraft cannot return to the Home Point when GPS signal is weak (  ) displaying less than four bars) or is unavailable.</p>
	<p>If you move the left stick when the aircraft is flying above 65 feet (20 meters) but below the pre-set Failsafe RTH altitude, the aircraft will stop ascending and immediately return to the Home Point.</p>

\* Make sure that the Landing Protection is enable in the DJI Pilot app.

### Obstacle Avoidance During RTH

The aircraft can sense and actively attempt to avoid obstacles during RTH, provided that lighting conditions are adequate for the Forward Vision System. Upon detecting an obstacle, the aircraft will act as follows:

1. The aircraft decelerates when an obstacle is sensed at approx. 49 feet (15 meters) ahead.
2. The aircraft stops and hovers then starts ascending vertically to avoid the obstacle. Eventually, the aircraft will stop climbing when it is at least approx. 16 feet (5 meters) above the detected obstacle.
3. RTH procedure resumes. The aircraft will continue flying to the Home Point at the current altitude.

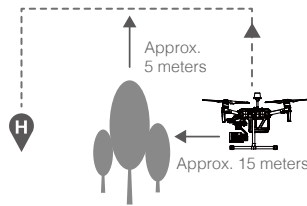

- 
- ⚠ • Obstacle Sensing is disabled during RTH descent. Proceed with care.
- To ensure the aircraft returns home forwards, it cannot rotate during RTH while the Forward Vision System is enabled.
  - The aircraft cannot avoid obstacles beside or behind it.
- 

### Landing Protection Function

Landing Protection will activate during auto-landing.

1. Landing Protection determines whether the ground is suitable for landing. If so, the aircraft will land smoothly.
2. If Landing Protection determines that the ground is not suitable for landing, the aircraft will hover and wait for pilot confirmation. The aircraft will hover if it detects the ground is not appropriate for landing even with a critically low battery warning. Only when the battery level decreases to 0% will the aircraft land. Users retain control of aircraft flight orientation.
3. If Landing Protection is inactive, the DJI Pilot app will display a landing prompt when the aircraft descends below 0.7 meters. Tap to confirm or pull down the control stick for 2 seconds to land when the environment is appropriate for landing.

- 
- ⚠ Landing Protection will not be active in the following circumstances:
- When the user is controlling the pitch/roll/throttle sticks (Landing Protection will re-activate when the control sticks are not in use)
  - When the positioning system is not fully functional (e.g. drift position error)
  - When the downward vision system needs re-calibration
  - When light conditions are not sufficient for the downward vision system
  - If an obstacle is within one meter of the aircraft, the aircraft will descend to 0.7m above the ground and hover. The aircraft will land after user confirmation.
-

### Center of Gravity Calibration

The center of gravity will shift when the aircraft payloads changes. To ensure stable flight, it is required to recalibrate the aircraft's center of gravity when a new payload is installed.

- 💡 • Calibrate in a windless environment. Make sure that the aircraft is hovering and there is a strong GPS signal during calibration.
- Maintain visual line of sight of the aircraft and pay attention to flight safety.

Calibration instructions: Go to Flight Controller Settings in the app, and tap Calibrate in the Center of Gravity Auto Calibration section. The Aircraft Status Indicators will glow solid purple during calibration. There will be a prompt in the app after calibration is completed.

### Spotlight Pro

Spotlight Pro (coming soon) is a powerful new tracking mode that allows a single pilot to capture complex, dramatic images. The gimbal will automatically adjust to keep the camera pointing at the subject. Lock onto a subject in Spotlight Pro mode and the gimbal will capture the locked subject regardless of the directions that the aircraft flies.

Instructions: Tap  in Camera View in the app, and then use your finger to draw a square around the object in to begin tracking.

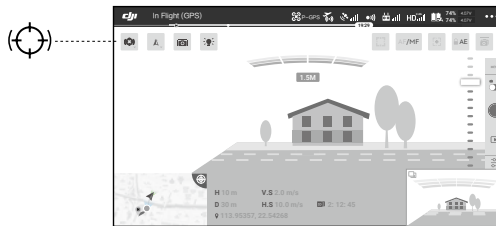

- ⚠️ • You can drag on a subject in DJI Pilot or move the gimbal control sticks to change the subject's position in the shot.
- Spotlight Pro can be used in S-mode, A-mode.

### Flight Recorder

Flight data is automatically recorded to the internal storage of the aircraft. You can connect the aircraft to a computer via the USB port and export this data via DJI Assistant 2.

### Attaching and Detaching the Propellers

#### Attaching the Propellers

Refer to "[Mounting the Propellers](#)" for details.

### Detaching the Propellers

Press the propeller down onto the mounting plate and rotate it in the unlock direction.

- ⚠ • Propeller blades are sharp; please handle with care.
- Only use DJI approved propellers. DO NOT mix propeller types.
- Stay clear of spinning motors. DO NOT touch the propellers when they are spinning.
- Ensure to check that the propellers and motors are installed firmly and correctly before each flight.
- Ensure that all propellers are in good condition before each flight. DO NOT use aged, chipped, or broken propellers.
- To avoid injury, stand clear of and DO NOT touch propellers or motors when they are spinning.
- Please use original DJI propellers for a better and safer flight experience.

### DJI Intelligent Flight Battery

The TB55 Intelligent Flight Battery has a capacity of 7660 mAh, a voltage of 22.8 V, and a smart charge/discharge functionality. The Intelligent Flight Battery must be fully charged before using it for the first time. It should only be charged using appropriate DJI approved chargers.

The battery firmware is included in the aircraft firmware. Make sure that all the batteries' firmware is up-to-date.

#### DJI Intelligent Flight Battery Functions

1. Battery Level Display: The LED indicators display the current battery level.
2. Auto-Discharging: To prevent swelling, the battery automatically discharges to below 70% of the total power when it is idle (press the power button to check that the battery level will cause the battery to exit idle state) for more than 10 days to prevent swelling. It takes around 11 days to discharge the battery to 65%. It is normal to feel moderate heat emitting from the battery during the discharge process.
3. Balanced Charging: Automatically balances the voltage of each battery cell when charging.
4. Overcharge Protection: Charging automatically stops when the battery is fully charged.
5. Temperature Detection: The battery will not be charged to avoid damage when the battery temperature is lower than 5 °C (41°F) or higher than 45°C (113°F).
6. Over Current Protection: The battery stops charging when a high amperage is detected.
7. Over Discharge Protection: Over-discharging can seriously damage the battery. Current output will be cut off when the battery cell is discharged to 2.8 V when not in flight mode. For extended flight times, over-charging protection is disabled as batteries discharge during flight. In this instance, a battery voltage below 2 V may cause a safety hazard such as a fire when charged. To prevent this, the battery will not be able to charge if the voltage of a single battery cell is below 2 V. Avoid using any batteries matching this description and avoid serious over-discharging to prevent permanent battery damage.
8. Short Circuit Protection: Automatically cuts the power supply when a short circuit is detected.
9. Battery Cell Damage Protection: DJI Pilot displays a warning message when a damaged battery cell is detected.
10. Sleep Mode: Sleep mode is entered to save power when the aircraft is not flying.
11. Communication: Information pertaining to the battery's voltage, capacity, current, etc. is transmitted to the aircraft's main controller.

- 12. Heating: Batteries are able to work even in cold weather, ensuring a safe flight. Refer to "Using the Battery" section for details.
- 14. Waterproof and Dustproof: The vehicle's new airframe design improves the Ingress Protection Rating to IP43 in accordance with the global IEC 60529 standards.

 Refer to the *Disclaimer* and *Intelligent Flight Battery Safety Guidelines* before use. Users take full responsibility for all operations and usage.

### Charging the Intelligent Flight Battery

The Intelligent Flight Battery Charging Hub is designed for use with the Battery Charger. It charges up to four Intelligent Flight Batteries simultaneously. The Charging Hub will intelligently charge batteries in sequence according to battery power levels from high to low. The Micro USB port is used for Charging Hub firmware updates.

#### Overview

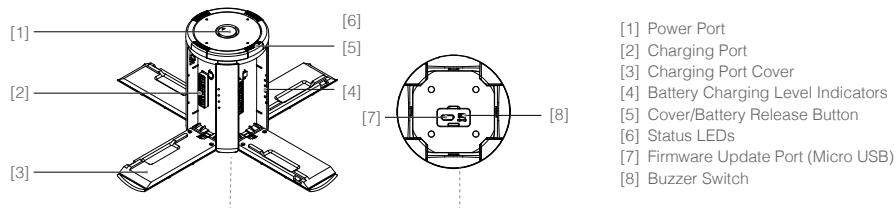

#### Connecting to a Power Source

Connect the standard Battery Charger to a power outlet (100-240 V, 50/60 Hz), then uncover the rubber cover on the power port to connect the Charging Hub to the Battery Charger\*.

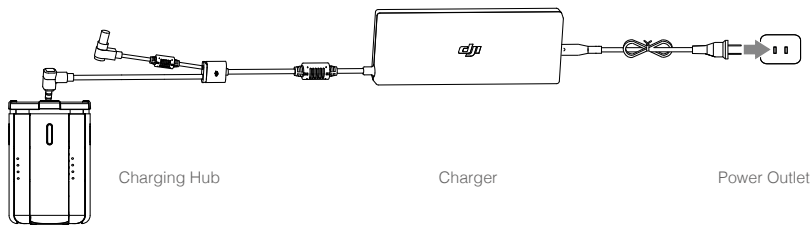

\* It will take approximately 2.5 hours to fully charge the TB55 Intelligent Flight Battery, and 2 hours for the remote controller. It will take a longer time to charge the Intelligent Flight Battery and remote controller together.

#### Connecting Batteries

Press the release button and open the corresponding charging port cover. Insert the Intelligent Flight Battery into the charging port to begin charging. The Charging Hub will intelligently charge batteries in sequence according to battery power levels from high to low. Refer to the "Status LED Description" section for more information about Status LED blinking patterns. The buzzer will begin beeping when charging is complete. Refer to the "Buzzer Beeping Description" for more information about buzzer beeping patterns.

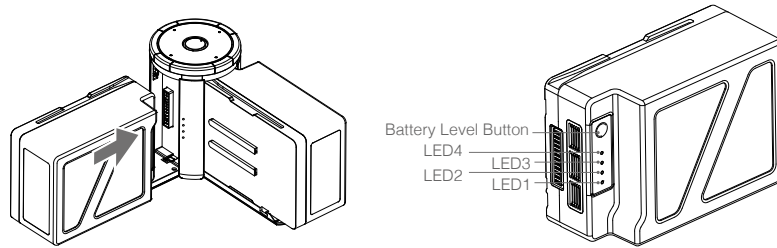

- ⚠ • Always align the grooves on the Intelligent Flight Battery with the battery slot tracks. Make sure the Status LED of the Charging Hub has a blinking pattern of charging or ready to charge indicating that the battery is inserted correctly.
- Press the release button to detach batteries after charging is complete.
- DO NOT leave metal terminals exposed to open air when not in use.

**Status LED Descriptions**

Status LED (Charging Hub)	Description
🔦 ..... Blinks Green	Charging
🔦 — Solid Green	Fully charged
🔦 ..... Blinks Red	Battery Charger Error. Retry with an official battery charger.
🔦 — Solid Red	Intelligent Flight Battery error
🔦 ..... Blinks Yellow	Battery temperature too high/low. Temperature must be within operating range (5°-40°C)
🔦 — Solid Yellow	Ready to charge
🔦 ... Alternating Green Blinks	Intelligent Flight Battery not detected

Battery Level Indicators while Charging (Battery)				Battery Level
LED1	LED2	LED3	LED4	
🔦	🔦	○	○	0%~50%
🔦	🔦	🔦	○	50%~75%
🔦	🔦	🔦	🔦	75%~100%
○	○	○	○	Fully Charged

**Charging Protection LED Display**

The table below shows battery protection mechanisms and corresponding LED patterns.

Battery Level Indicators for Battery Protection					
LED1	LED2	LED3	LED4	Blinking Pattern	Battery Protection Item
○	🔦	○	○	LED2 blinks twice per second	Over current detected
○	🔦	○	○	LED2 blinks three times per second	Abnormal battery cell voltage detected

○	○	☀	○	LED3 blinks twice per second	Over charge detected
○	○	☀	○	LED3 blinks three times per second	Over-voltage charger detected
○	○	○	☀	LED4 blinks twice per second	Charging temperature is too low (<0°C)
○	○	○	☀	LED4 blinks three times per second	Charging temperature is too high (>40°C)

After any of the above mentioned protection issues are resolved, press the button to turn off the Battery Level Indicator. Unplug the Intelligent Flight Battery from the charger and plug it back in to resume charging. Note that you do not need to unplug and plug the charger in the event of a room temperature error, the charger will resume charging when the temperature falls within the normal range.

⚠ DJI does not take any responsibility for damage caused by third-party chargers.

- 💡 • To ensure safety, discharge the battery before transporting the aircraft. Fly the aircraft outdoors until its power level is lower than 30%.
- The battery has a capacity of 174.6 Wh. Please follow the regulations and guidelines for traveling with these batteries via air.

#### Buzzer Beeping Description

Toggle the buzzer switch to turn on/off the warning sound.

Descriptions	Beeping Pattern
Toggle the buzzer switch to turn it on	Quick beeping
Connect to the Battery Charger	Quick beeping
A battery pair is fully charged	Quick beeping
Four Intelligent Flight Batteries are fully charged	Alternating between two short and one long beep, lasting for about 1 hour

#### Updating the Firmware

DJI will release firmware updates when available. Refer to the official DJI website and follow the instructions below to update the firmware.

1. Download the latest firmware update program from the official DJI website.
2. Turn on the Charging Hub, then connect it to a computer using a Micro USB cable.



3. Run the firmware update program. Press the update button and wait for the process to finish.
4. The Charging Hub will automatically restart when the update has been successfully completed.
5. Repeat this process if the firmware update fails for any reason.

### Using the Battery

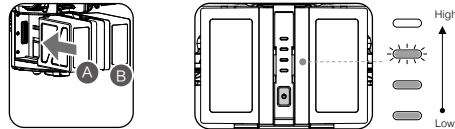

### Pairing Batteries

Before first use, it is recommended to mark 2 batteries as a pair and continue using them as a pair (charge and discharge them together) to maximize service life and ensure flight performance. If two batteries with a significant difference in battery life are installed and powered on, a prompt will pop up in the app to recommend that you replace the batteries to a pair with similar performance.

### Turning ON/OFF

**Turning On:** Press the Power button once, then press again and hold for two seconds to power on. The Power LED will turn white and the Battery Level Indicators will display the current battery level.

**Turning Off:** Press the Power button once, then press again and hold for two seconds to power off.

### Heating the Battery

**Manual Heating:** If the Intelligent Flight Battery is not installed into the aircraft, press and hold the battery level button on the battery for four seconds to initiate the self-heating, keeping the batteries at a temperature between 61° F (16° C) and 68° F (20° C), which is the ideal range of operating temperature, for approximately 30 minutes. Press and hold the battery level button for two seconds to stop heating.

**Auto Heating:** Insert the batteries into the aircraft and power it on. If a low battery temperature is detected, the battery will automatically heat up to maintain a temperature between 61° F (16° C) and 68° F (20° C).



### Low Temperature Notice:

































1. The performance of the intelligent Flight Battery is significantly reduced when flying in low temperature environments (temperatures below 5°C). Ensure that the battery is fully charged and the cell voltage is at 4.35 V before each flight.
2. End the flight as soon as DJI Pilot displays the "Low Battery Level Warning" in low temperature environments. You will still be able to control the aircraft's movement when this warning is triggered.
3. In extremely cold weather, the battery temperature may not be high enough even after warming up. In these cases, insulate the battery as required.
4. To ensure optimal performance of the battery, keep the battery temperature above 16°C.
5. In low temperature environments, it will take a longer time for the batteries to warm up. It is recommended to keep the battery warm before use to reduce the warm-up time.

**Checking Battery Levels**

Battery Level Indicators display how much power remains. When the battery is turned off, press the Power button once and the Battery Level Indicators LEDs will display the current battery level. See below for details.

 The Battery Level Indicators will also show the current battery level during discharging. The indicators are defined below.

 : LED is on.       : LED is off.       : LED is flashing.

Battery Level				
LED1	LED2	LED3	LED4	Battery Level
				88%~100%
				75%~88%
				63%~75%
				50%~63%
				38%~50%
				25%~38%
				13%~25%
				0%~13%

**D-RTK (for M210 RTK V2)**

**Introduction**

The M210 RTK V2 aircraft has a built-in DJI Onboard D-RTK 2, which can withstand magnetic interference from metal structures, ensuring stable flight. More accurate positioning data can be achieved when using a DJI D-RTK 2 High Precision GNSS Mobile Station for Matrice Series. If the RTK signal is weak and differential data cannot be transmitted during flight, users can read the raw satellite observations\* recorded in the aircraft after the flight, and then use PPK technology to achieve centimeter-level positioning.

\* The raw satellite observations will be recorded when the RTK function is enabled on the aircraft and the search for satellites is finished. Connect the aircraft to a computer to obtain the observations in the directory \rtk\_data\rtk\_rtc in the removable disk corresponding to the aircraft.

**Enable/Disable RTK**

Ensure that the "Aircraft RTK" is enabled and RTK service type is correctly set (D-RTK 2 Mobile Station) before each use. Go to Camera View in the app > ●●● > RTK to view and set.

Make sure to disable RTK function if not in use. Otherwise, the aircraft will not be able to take off when there is no differential data.

**Using with the DJI D-RTK 2 Mobile Station**

1. Refer to the D-RTK 2 Mobile Station for Matrice Series User Guide to complete linking between the aircraft and the mobile station and setup of the mobile station.
2. Power on the mobile station and wait for the system to start searching for satellites. In the RTK Settings page in the app, the status of both the aircraft's orientation and positioning in the status table will show "FIX" to indicate that the aircraft has obtained and used the differential data from the mobile station.

## DJI AirSense

Airplanes and helicopters with an ADS-B transceiver will actively broadcast flight information including location, flight path, speed, and altitude. DJI AirSense receives this by ADS-B transceivers via an on-board receiver or internet connection. UAVs installed DJI AirSense can obtain the position, orientation and velocity information from the manned airplane built-in ADS-B transmitter (1090 ES and UAT standard supported), calculate the collision risk level real time and send the warning to user. The system will analyze the potential risk of collision by comparing the location of an airplane or a helicopter, sending timely warnings to pilots via the DJI Pilot app.

DJI AirSense provides users with information about nearby airplanes and helicopters to ensure flight safety. The system doesn't actively control the drone to avoid incoming airplanes or helicopters. Always fly your aircraft within a visual line of sight and be cautious at all times. Lower your altitude when you receive warnings. Please be aware that DJI AirSense has the following limitations:

1. It can only receive messages sent by airplanes and helicopters installed with an ADS-B out device and in accordance with 1090ES (RTCA DO-260) or UAT (RTCA Do-282) standards. DJI devices will not receive related broadcast messages or send out warnings for airplanes or helicopters without ADS-B outs or with malfunctioning ADS-B outs.
2. If there is an obstacle or steel structure between airplanes or helicopters and DJI aircraft, the system won't be able to receive ADS-B messages sent by airplanes or helicopters or send out warnings. Keenly observe your surroundings and fly with caution.
3. Warnings may be sent with delay when the DJI AirSense is interfered by the surrounding. Keenly observe your surroundings and fly with caution.
4. Warnings are not sent when a DJI aircraft is unable to determine its location.
5. It cannot receive ADS-B messages sent by airplanes or helicopters or send out warnings when disabled or misconfigured.

On the precondition that connection between a DJI aircraft and the pilot remote controller is stable, when the system confirms the possibility of a collision, it will send a series of warnings based on the distance between drone and airplanes or helicopters. We recommended that the operator descend altitude immediately after the first warning to avoid a collision, choosing another flight path where necessary.

### Warning Escalation:

The first (or "lowest") level warning occurs three minutes away from the airplanes or helicopters. The second (or "middle") level warning occurs two minutes away from the airplanes or helicopters. The third (or "highest") level warning occurs one minute away from the airplanes or helicopters.



Blue: The first level warning



Yellow: The second level warning



Red: The third level warning

## Components at the Rear of the Aircraft

M210 V2/M210 RTK V2 provides several I/O ports, which can be customized in the DJI Pilot app. The aircraft also has components such as Extended Power Port, USB Mode Switch, Linking Button, and USB Port.

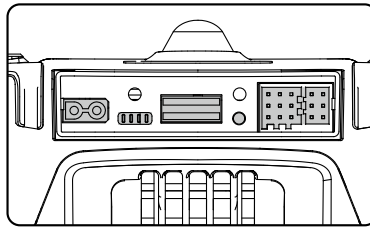

### Extended Power Port (XT30)

Used to supply power for other device, whose voltage range is from 18 V to 26 V (the voltage varies according to the aircraft battery level) with a current of 4 A. Make sure your device meets the voltage and current requirement. The use of a device with a power that exceeds the maximum may affect flight performance adversely or even cause aircraft damage.

### USB Mode Switch

Power on the Intelligent Flight Battery and slide the USB Mode Switch right, and connect the USB port on the aircraft to the computer via the USB to USB cable included in the package. Once connected, you can access photos and videos in the microSD card (for the X4S, X5S, and X7), flight records or configure aircraft parameters and run firmware updates using the DJI Assistant 2 for Matrice. OSDK devices can also be connected to the USB port when the switch is slid to the right.

### USB Port

The USB port is used to connect to a computer or OSDK devices. The corresponding devices can be connected when the USB mode switch is slid to different positions. The USB port can supply power with a maximum voltage of 5V and maximum current of 1A when the switch is slid to the left.

### Linking Button and Indicator

Used to link between aircraft and remote controller, and the built-in LED will display the linking status during linking procedure.

### Expansion Ports

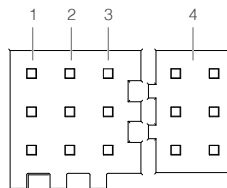



**Pins Descriptions**

PWM power level is 3.3V and all pins can be configured in DJI Pilot app.

Number	1	2	3	4	
Name	I/O port	I/O port	OSDK port	Especially for an external GPS Kit*	
Pins (from up to down)	TIMESYNC	GND	GND	/	/
	PWM3/GPIO3	PWM4/GPIO4/ HARDSYNC	SDK_RX	/	/
	PWM1/GPIO1	PWM2/GPIO2	SDK_TX	/	/

\* An external GPS Kit is required when a single upward gimbal or other payload is used on the M210 V2.

-  It is required to enable the expansion ports in the app before first-time use. Go to Camera View >  > Extended IO Configuration to set.
- Make sure to install two batteries to the aircraft, power on the aircraft and wait for the system to be ready when the power supply port is enabled in the app. Otherwise the expansion ports cannot be used. When using in low-temperature environments, the batteries must be preheated.

**Usage of the TIMESYNC Pin**

The TIMESYNC pin is for the TimeSync function. This function uses the PPS signal of the GPS module or RTK module to synchronize the aircraft time to the UTC time, and provides the Onboard SDK users with the precise UTC time of the rising edge of the TIMESYNC output pulse. Users can apply this UTC timestamp to the data from their third-party payloads to achieve precise time synchronization.

-  The TIME\_SYNC pin provides output of the raw GPS and RTK data in GSA and RMC types in the NMEA standard. For the M210 RTK V2 aircraft, if RTK is disabled, the output will be the PPS signal of 5 Hz from the GPS module. If RTK is enabled, the output will be the PPS signal of 5 Hz from the GPS module before the RTK module receives satellite data. Once the RTK module receives satellite data, the output will always be the PPS signal of 1 Hz from the RTK module. For the M210 V2 aircraft, the output will always be the PPS signal of 5 Hz from the GPS module.

**Usage of the HARDSYNC Pin**

The HARDSYNC pin is for the flight controller time synchronization function. This function uses the synchronization hardware signal from the flight controller to synchronize the data from the aircraft's sensors (such as IMU, Vision System, camera) to the same clock source. It is an autonomous time synchronization method that does not rely on external information so that it can achieve precise flight controller time synchronization even in environment without satellite signals such as indoors or area with building obstruction.

-  The HARDSYNC pin provides output of the data such as IMU data, images from the Vision System, and camera data from the aircraft's sensors. The output will start with a pulse frequency of 20 Hz once the aircraft is powered on.

### Mounting the Waterproof Rear Port Cover

Users can customize a waterproof cover after connecting devices to the rear ports to ensure the level of ingress protection.

First, remove the two screws in the rear of the aircraft and then remove the standard cover. Then mount your own waterproof cover.

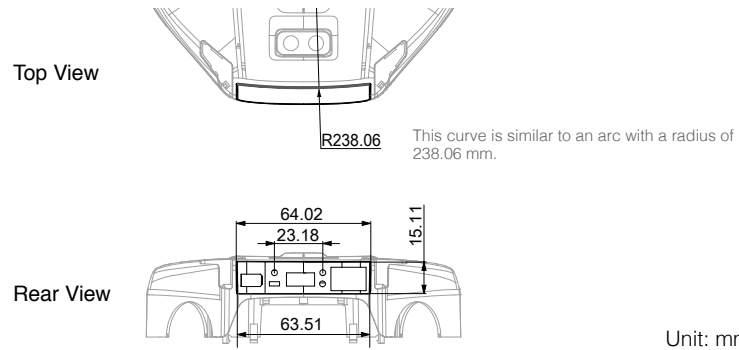

Unit: mm

Refer to the 3D model file on the official DJI website for detailed dimensions.

## Remote Controller

---

This section describes the features of the remote controller that includes aircraft and remote controller operations.

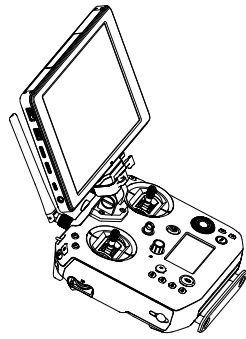

## Remote Controller

### Remote Controller Profile

The CENDENCE™ S remote controller features DJI's OcuSync 2.0 technology for a maximum transmission distance of up to 5 mi (8 km).<sup>\*</sup> Equipped with a DJI CrystalSky 7.85 inch ultra-bright monitor, it displays a HD live view directly via the built-in DJI Pilot app, providing a precise and responsive flying experience. Dual frequency<sup>\*</sup> support makes the HD video downlink more stable. In Dual Remote Controller Mode, two remote controllers control the aircraft and camera separately, even when they are up to 656 feet (200 m) apart.<sup>\*</sup>

The remote controller works with a WB37 Intelligent Battery, which can be fully charged via the charging port in about 2 hours with the standard charger, or with the Intelligent Battery Charging Hub in about 1 hour and 11 minutes. The maximum run time of the remote controller is approximately 4 hours without supplying power to a monitor and with Dual Remote Controller mode disabled.<sup>\*</sup>

<sup>\*</sup> The remote controller can reach its maximum transmission distance (FCC) in an unobstructed area with no electro-magnetic interference at an altitude of about 400 feet (120 meters). The actual maximum transmission distance may be less than the distance mentioned above due to interference in the operating environment, and the actual value will fluctuate according to the strength of interference.

To comply with local regulations, the 5.8 GHz frequency is not available in some countries and regions.

The Dual Remote Controller mode will be supported later.

Maximum run time is estimated in a lab environment without supplying power to a smart device or monitor, for reference only.

- 
- **Compliance Standards:** The remote controller is compliant with local laws and regulations.
  - **Stick Mode:** Controls can be set to Mode 1, Mode 2, or to a custom mode.
  - **Mode 1:** The right stick serves as the throttle.
  - **Mode 2:** The left stick serves as the throttle.
  - Please refer to the CrystalSky User Guide for more CrystalSky details.

---

⚠ Do not operate more than three aircraft within the same area (roughly the size of a soccer field) to prevent transmission interference.

---

### Preparing the Remote Controller

#### Mounting/Removing the Intelligent Battery

Put the battery into the Battery Slot, then slide it to the end until you hear a click.

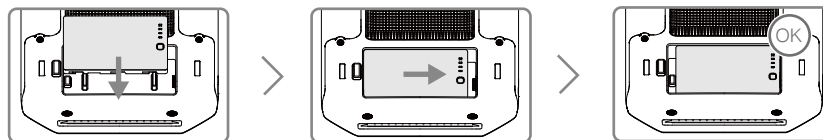

- 
- ⚠ • Press the Battery Release Button before removing the battery.
  - Press the Battery Level Button once to check the battery level.
-

### Charging the Battery

The remote controller is powered by a WB37 intelligent battery, which can be charged via the charging port or by the WCH2 Intelligent Battery Charging Hub.

#### Using the Charging Port

Place the battery into the remote controller, and connect connector B of the battery power port, then connect the battery charger to a power outlet (100-240V, 50/60Hz). When charging is complete, the display on the remote controller will show 100%.

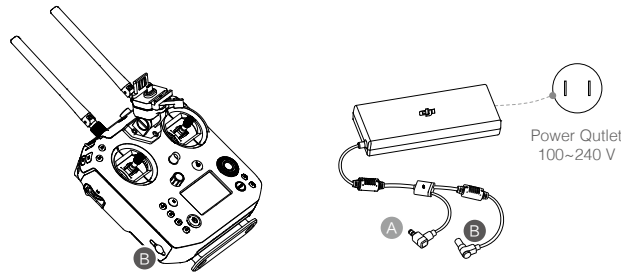

Charging Time: 2 hours

#### Using the Charging Hub

Place the battery into the Charging Hub, and connect connector B of the battery charger to the charging hub, then connect the battery charger to a power outlet (100-240V, 50/60Hz). The Charging Hub will intelligently charge batteries in sequence according to battery power levels from high to low. The buzzer will begin beeping when charging is complete. Remove the battery or turn off the Buzzer Switch to stop it.

The charging hub blinks green while charging and turns solid green when charging is finished.

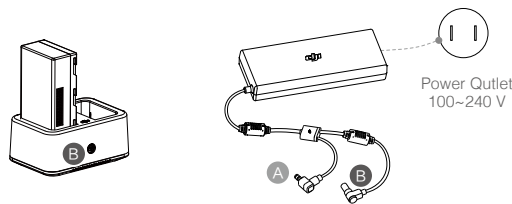

Using the WCH2 Charging Hub, charging time is approximately 1 hour and 11 minutes (for one battery).

---

 Place the battery into the Charging Hub, and connect connector B of the battery charger to the charging hub, then connect the battery charger to a power outlet (100-240V, 50/60Hz).

---

-  • USB power supply port can be used to charge the mobile device of 5V/2A.  
• Refer to the WCH2 Charging Hub User Guide for more details.
-

## Mounting the Monitor to the Remote Controller

### Mounting the DJI CrystalSky Monitor

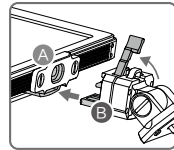

Ensure that Part B is unlocked. Connect Part B to Part A.

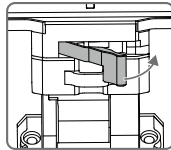

Lock the Mounting Bracket.

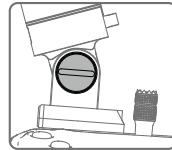

Use a coin or the screwdriver included to adjust the tightness of the tilt axis.

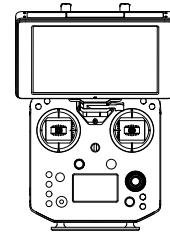

### Mounting the Other Mobile Devices

For other mobile devices (e.g. iPhones, iPads), the Cendence Mobile Device Holder and an appropriate USB cable are required.

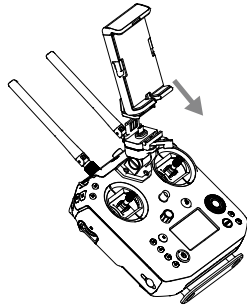

Unlock the Mounting Bracket and mount the Mobile Device Holder.

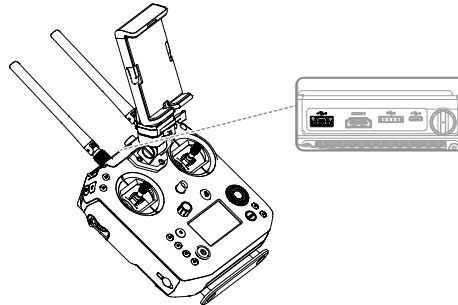

Lock the Mounting Bracket, and connect your mobile device.

Attach your mobile device, then tighten the clamp to secure it. Connect your mobile device to the remote controller with a USB cable. Plug one end of the cable into your mobile device, and the other end into the USB port on the back of the remote controller.

## Remote Controller Operations

### Button Types

Users can use the preconfigured buttons to control the aircraft and the camera and can also assign functions to the customizable buttons through the DJI Pilot app. There are three types of button:

1. Preconfigured buttons for aircraft control, e.g. the Pause Button, RTH Button, etc.
2. Preconfigured buttons for camera control, e.g. the Shutter Button, Recording Button, Focus Adjustment Knob, etc.
3. Customizable buttons and knobs that you can set through the DJI Pilot app.

### Turning the Remote Controller On and Off

Follow the steps below to turn the remote controller on and off.

1. Press the power button once to check the current battery level. Charge the remote controller if the battery is too low.
2. Next, press and hold the Power button to power on the remote controller.
3. Repeat step 2 to power off the remote controller after you finish using it.

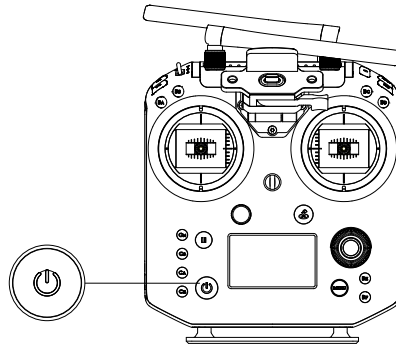

**Operating the Aircraft**

**Controlling the Aircraft**

This section explains how to control the orientation of the aircraft through the remote controller. Control can be set to Mode 1, Mode 2 or Mode 3, or to a custom mode.

**Mode 1**

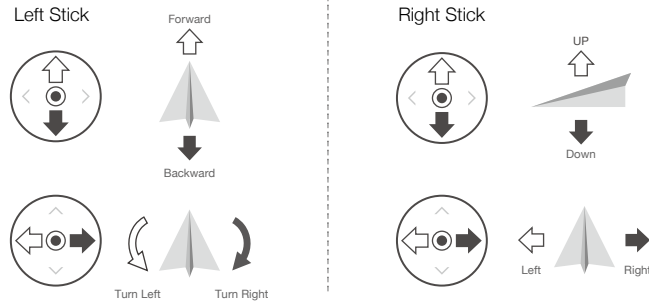

**Mode 2**

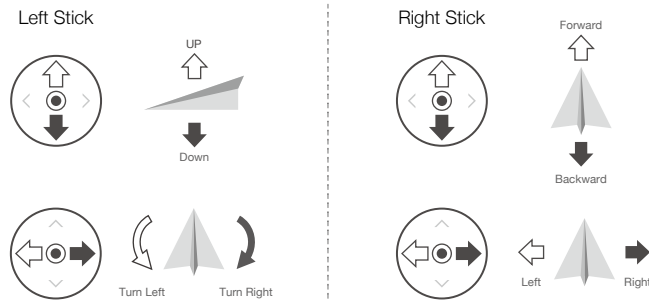

**Mode 3**

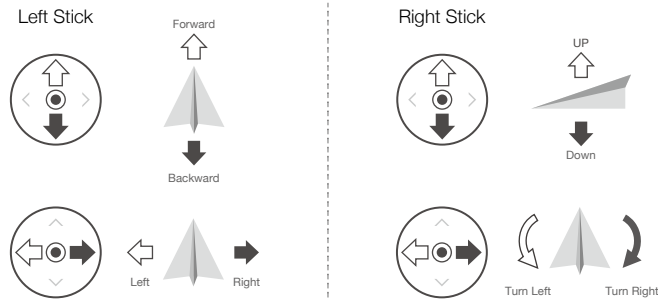







The Stick Mode is set to Mode 2 by default.

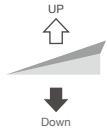

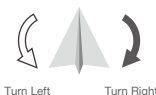
Stick Neutral/Mid-Point: Control sticks are centered.



Moving the Control Stick: Control sticks are pushed away from the center.

Remote Controller (Mode 2)	Aircraft	Remarks
<p>Left Stick</p> 		<p>Moving the left stick up and down changes the aircraft's elevation.</p> <p>Push the stick up to ascend and down to descend. When both sticks are centered, the aircraft will hover in place.</p> <p>The more the stick is pushed away from the center position, the faster the aircraft will change elevation. Always push the stick gently to prevent sudden and unexpected elevation changes.</p>
		<p>Moving the left stick to the left or right controls the rudder and rotation of the aircraft.</p> <p>Push the sick left to rotate the aircraft counter clockwise, and push the stick right to rotate the aircraft clockwise. If the stick is centered, the aircraft will maintain its current orientation.</p> <p>The more the stick is pushed away from the center position, the faster the aircraft will rotate.</p>
<p>Right Stick</p> 		<p>Moving the right stick up and down changes the aircraft's forward and backward pitch.</p> <p>Push the stick up to fly forward and down to fly backward. The aircraft will hover in place if the stick is centered.</p> <p>Push the stick further away from the center position for a larger pitch angle and faster flight.</p>
		<p>Moving the right stick control left and right changes the aircraft's left and right pitch.</p> <p>Push left to fly left and right to fly right. The aircraft will hover in place if the stick is centered.</p> <p>Push the stick further away from the center position for a larger pitch angle and faster flight.</p>

**Flight Mode Switch**

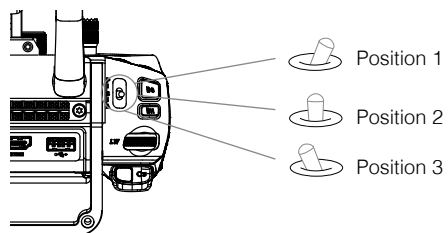
Toggle the switch to select the desired flight mode. Choose between; P-mode, S-mode, and A-mode.



Position	Figure	Flight Mode
Position 1		P-mode
Position 2		S-mode
Position 3		A-mode

The Flight Mode Switch is locked to P-mode, regardless of the Flight Mode Switch's position. To change flight modes, go to the Camera View in DJI Pilot and enable Multiple Flight Modes in Main Controller Settings. After enabling multiple flight modes, toggle the switch to P for Position mode and S for Sport Mode.

**RTH Button**

Press and hold the RTH button to start the Return to Home (RTH) procedure. The aircraft will then return to the last recorded Home Point. Press this button again to cancel the RTH procedure and regain control of the aircraft.

Determine RTH status by sound:

Single beep... Request to return, but not receive the respond from the aircraft yet.

Double beep... RTH in progress.

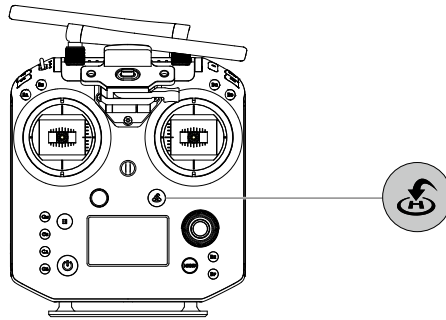

**Controlling the Gimbal**

Use the left dial and right dial to adjust the gimbal tilt.

		<p>The left dial controls the gimbal tilt. Turn the dial to the right, and the gimbal will shift to point upwards. Turn the dial to the left, and the gimbal will shift to point downwards. The camera will remain in its current position when the dial is static.</p>
		<p>The right dial controls the gimbal pan. Turn the dial to the right, and the gimbal will shift clockwise. Turn the dial to the left, and the gimbal will shift counter clockwise. The camera will remain in its current position when the dial is static.</p>

### Operating the Camera

Shoot videos/photos with the Shutter Button and Video Recording Button on the remote controller.

1. Shutter Button  
Press to take a photo. Photos can be taken even while recording video.
2. Video Recording Button  
Press once to start recording video, then press again to stop recording.
3. Autofocus button  
Press once to focus automatically.
4. Focus Adjustment  
Rotate Focus Adjustment Knob to set the focal length.

### Controlling the FPV Camera

When the C2 button on the remote controller is undefined, press and hold C2 and turn the left dial to control the pitch of the FPV camera. The FPV camera cannot be controlled if the C2 button is set to other function.

### Configuring the Customizable Buttons

Go to the Customizable Button Settings Menu in DJI Pilot. Here you can set functions for the left C1-C4 buttons, and BA-BH buttons.





### Linking the Remote Controller

The remote controller comes linked to your aircraft before delivery. Linking is only required when using for the remote controller for the first time. Follow these steps to link a remote controller:

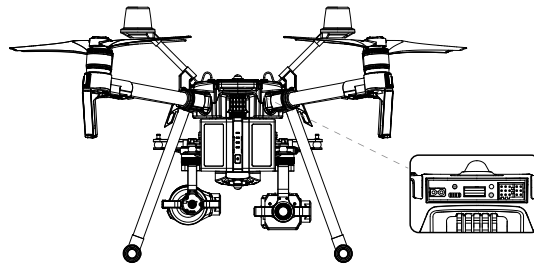
1. Power on the remote controller, connect to your mobile device, and launch DJI Pilot.
2. Power on the Intelligent Flight Battery.
3. Enter the Camera View > , and tap the Linking Remote Controller button.
4. The DJI Pilot app will display a countdown box, the remote controller will be ready to link, with its display showing Connecting and a beeping sound being emitted.
5. Locate the Linking button on the aircraft and press the Linking button to start linking. The remote controller display shows the current status information.



- 
-  • Restart the remote controller and try again if the remote controller display shows No Connection indicating that linking failed.
  - A remote controller will disconnect from the linked aircraft if a new remote controller is linked to the same aircraft.
- 

-  Press the C1 and C2 buttons and the Start/Stop button for fast linking.
-

### Mounting the Control Stick Covers

1. Remove the rings around the sticks with the Control Stick Cover Mounting Key, and the screws on the top of the sticks.
2. Mount the Control Stick Covers to the remote controller and secure them with the Control Stick Cover Mounting Key.
3. Reattach the screws to the sticks.



---

 The two Control Stick Covers are not the same, and neither are the two rings around the sticks. The left and right Control Stick Covers and rings can be distinguished using the figures below. Be sure to install each Control Stick Cover on the correct side.

---

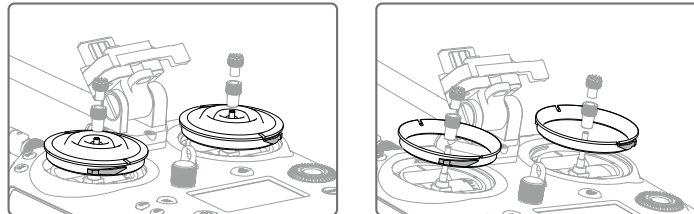

## Gimbal and Camera

---

This section focuses on the technical specifications of the camera and explains how to use the gimbal.

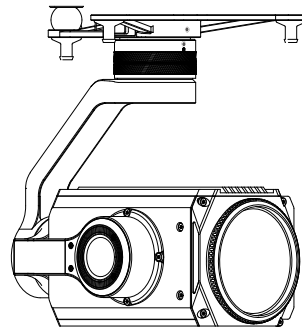

## Gimbal and Camera

### Camera

#### Camera Profile

Using the Zenmuse Z30 / X5S as an example, this section will demonstrate the technical specifications of the camera while explaining how to use the gimbal.

#### Camera microSD Card Slot

When using a Zenmuse X4S, X5S or X7, to store photos and videos, plug the microSD card into the slot shown below before powering on the aircraft. The aircraft comes with a 64 GB microSD card which was inserted into the slot before delivery and can support card sizes of up to 128 GB. We recommend you use a UHS-I type microSD card with a write speed at least 20 MB/s because the fast read and write capability of these cards enables you to store high-resolution video data.

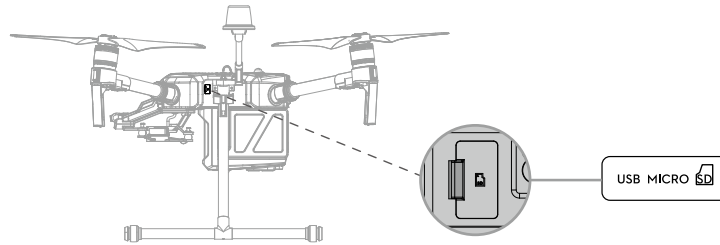

- 
- ⚠ The M210 V2 / M210 RTK V2 currently supports the following microSD.
- Lexar 633X UHS-I microSDXC 64GB (model: LSDMI64GBBAP633A)
  - Samsung PRO Endurance UHS-I microSDXC 64GB (model: MB-MJ64G)

- 
- ⊘
- Do not remove microSD card from the aircraft when it is powered on.
  - To ensure the stability of the camera system, single video recordings are capped at 30 minutes.
- 

#### Camera Operation

##### Remote Controller

Use the Shutter and Record buttons on the remote controller to shoot photos or videos. For more information on how to use these buttons, please refer to [Operating the Camera](#).

##### DJI Pilot

Use DJI Pilot to shoot photos or videos. For more information, refer to the camera and gimbal User Manual.

- 
- ⚠ When using the M200 Series V2 with the X5S or X7, some functions and parameters are unavailable, such as functions requiring an SSD, color settings of D-Cinelike, D-Log and Film Locks for the X5S, photo size of 3:2\* for the X7.
- 

\* Supported later.

## Gimbal

### Gimbal Profile

The 3-axis gimbal provides a steady platform for the attached camera, allowing you to capture stabilized images and video. Users can control gimbal angles using the remote controller or the app.

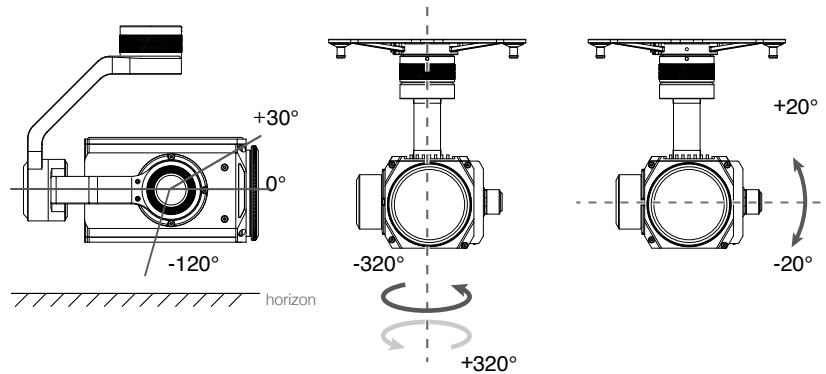

### Using the DJI Pilot App to Control Gimbal

Follow the steps below to use the DJI Pilot app to control gimbal orientation:



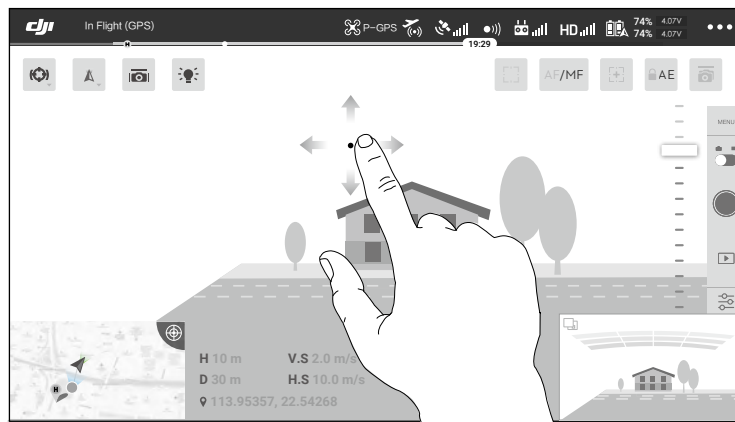

1. Launch DJI Pilot and enter the Camera View.
2. Tap and press on the screen until a blue circle is shown.
3. Slide to control the gimbal's orientation within the Camera View as shown below.

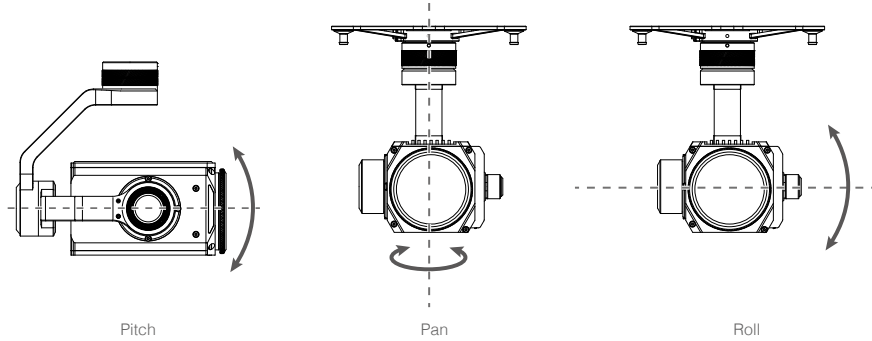

### Gimbal Operation Modes

Three gimbal operation modes are available. Switch between the different operation modes in DJI Pilot's Camera View. Note that your mobile device must be connected to the remote controller for changes to take effect. Refer to the table below for details:



	 Follow Mode	When the aircraft turns horizontally, the gimbal will pan with the aircraft so that the relative angle of the gimbal and the aircraft's heading remains the same.
	 Free Mode	The gimbal pan will remain unchanged when the aircraft's orientation changes.
	 Reset	The gimbal will pan to realign with the aircraft's nose. The gimbal pitch will realign to the central position.

-  • DO NOT block the gimbal. Place the aircraft on a flat, open area before taking off. Do not touch the gimbal after powered on.

## DJI Pilot App

---

This section introduces the main functions of the DJI Pilot app.

## DJI Pilot App

The DJI Pilot app is specifically developed for enterprise users. Manual flight integrates a variety of professional features that make flying simple and intuitive. Mission flight supports flight planning, and allows you to control the drone automatically, making your workflow much simpler and more efficient.



### Manual Flight

Enter the Camera View by tapping Manual Flight. The descriptions below use a Z30 gimbal camera as an example.

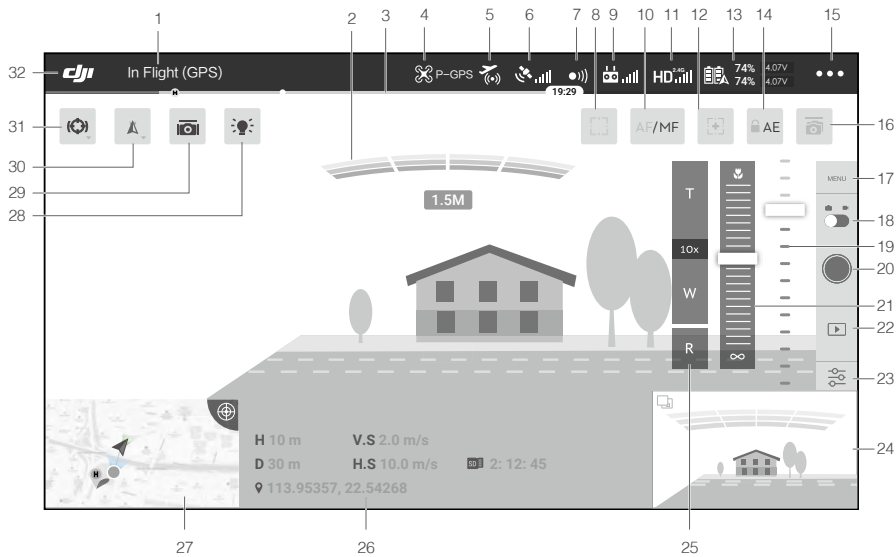

1. System Status Bar

 : This icon indicates aircraft flight status and displays various warning messages.

2. Obstacle Detection Status

 : Red bars are displayed when obstacles are close to the aircraft. Orange or yellow bars are displayed when obstacles are within the detection range.

3. Battery Level Indicator Bar

 : The battery level indicator provides a dynamic display of the battery level. The colored zones on the battery level indicator represent the power levels needed to carry out different functions.

4. Flight Mode

 : The text next to this icon indicates the current flight mode. Tap to configure the Flight Controller settings. These settings allow you to modify flight limits and set gain values.

5. AirSense Status

 : AirSense Status displays information about nearby manned aircraft to ensure flight safety, including the distance between DJI aircraft and manned aircraft. AirSense will instruct users to land if nearby aircraft are detected.

6. GPS Signal Strength

 : Shows the current GPS signal strength. For the M210 RTK V2, "R" will be displayed on the lower right corner if the aircraft RTK is enabled.

7. Obstacle Sensing Function Status

 : Tap this icon to enable or disable features provided by the Vision System, and it displays the status for all vision systems.

8. Focus/Metering Button

 : Tap to switch between the focus and metering modes. Tap to select an object for focusing or metering. Auto Focus-Continuous will be triggered automatically according to the status of the aircraft and camera after enabling Auto Focus.

9. Remote Controller Signal

 : This icon shows the strength of the remote controller signal. The icon will blink when an interference is recognized during flight. When there are no additional warnings in DJI Pilot, it means that the interference will not affect operation and overall flight experience.

10. AF/MF

AF/MF : Tap to switch the focus mode.

11. HD Video Link Signal Strength

 : This icon shows the strength of the HD video downlink connection between the aircraft and the remote controller. The text on top indicates the frequency in use. Tap for image transmission settings.

12. Zoom

 : Tap to enter zoom mode. Tap the screen to zoom into the pre-set TapZoom value automatically. Manual zoom can be done by tapping the icon to pull out the zoom menu.

13. Battery Settings

 : Shows the current battery level. Tap to view the battery information menu, set the various battery warning thresholds, and view the battery warning history.

14. Auto Exposure Lock

 AE : Tap to lock the exposure value. AE

15. More Settings

Tap ●●● to enter the extended menu to view and adjust the parameters of all other settings.

 : Flight Controller Settings — Includes Home Point settings, Return to Home altitude, maximum altitude, distance limit, sensors state, remote controller signal lost action, remote controller signal lost action, center of gravity auto calibration, extended IO options, etc.

●||) : Perception Settings — Includes enabling obstacle sensing, vision positioning, and RTH obstacle detection, etc.

 : Remote Controller Settings — Includes stick mode, Cendence custom settings, remote controller calibration, linking, etc.

HD : Image Transmission Settings — Includes camera for image transmission (to set the source for the main and assistant camera preview), work frequency, channel mode and video output, etc.

 : Aircraft Battery Settings — Includes low battery warning thresholds, battery information, etc.

 : Gimbal Settings — Includes gimbal pitch and pan settings, TapZoom magnification (for the Z30 gimbal and camera), gimbal calibration, etc.



RTK: RTK Settings — Includes RTK function switch, RTK service type and their corresponding settings.

●●● : Common Settings — Includes flight route display, units of measurement, live stream, etc.

16. Dual Gimbal Control

 : Tap to enable dual gimbal control function to control the pitch and pan of two gimbals simultaneously.

17. Camera Settings

Tap to enter the photo and video settings. Tap  to configure photo settings such as photo mode and image format. Tap  to configure video settings such as video size and format. Tap  to configure video caption, grid and smart LED settings (to enable/disable arm LEDs, beacon LEDs and status LEDs). The settings may vary according to different camera models.

18. Shoot/Record Button

 : Tap to start shooting photos or recording video.

19. Gimbal Slider

 : Displays the gimbal tilt angle.

20. Shutter / Record Button

 : Tap to shoot photos or start/stop recording. Users can also press the Shutter or Record button on the remote controller to shoot photos or record video.

21. Manual Focus

Only available in MF mode. Focus can be adjusted manually.

22. Playback

 : Tap to enter Playback and preview photos and videos as soon as they are captured.

23. Parameter Settings

 : Tap to set ISO, shutter, exposure values and other parameters.

24. FPV Camera / Gimbal Camera Preview

FPV camera preview will be displayed if using a single gimbal. Preview of the other gimbal and camera will be displayed if using dual gimbal. Users can also select the display source in Image Transmission Settings page.

25. Zoom Menu

Tap and hold T to zoom in. The magnification will be displayed under the button. Tap and hold W to zoom out. Tap R to reset the magnification to 1x.

26. Flight Telemetry

**D 30 m** : Horizontal distance between the aircraft and the Home Point.

**H 10.0 m** : Height from the Home Point.

**HS 10.0 m/s** : Aircraft horizontal speed.

**VS 2.0 m/s** : Aircraft vertical speed.

**📍 113.95434, 22.54764**: The longitude and latitude of the aircraft.

**SD 2:12:45** : Shows the remaining capacity or recording duration.

27. Map

Tap to view the map. Tap the icon on the upper right corner to show the flight attitude and radar display.

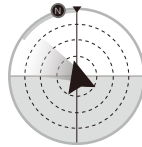

- The red arrow shows which direction the aircraft is facing.
- The ratio of gray area to blue area indicates the aircraft's pitch.
- The horizontal level of the gray area indicates the aircraft's roll angle.
- A green arc indicates the gimbal's pan angle.

28. Beacon

**📶** : Tap to turn on/off the beacons.

29. Gimbal Stabilization

This icon will be displayed only if using a Z30 gimbal camera. Tap to enable gimbal stabilization to reduce image shake during zoom.

30. Gimbal Operation Mode

**⬆️** : Tap to switch between Follow mode and Free mode, or to reset the gimbal.

31. Spotlight Pro

**🔦** : Tap to enable or disable Spotlight Pro. Heat Track is available when using an XT2 camera.

32. Back







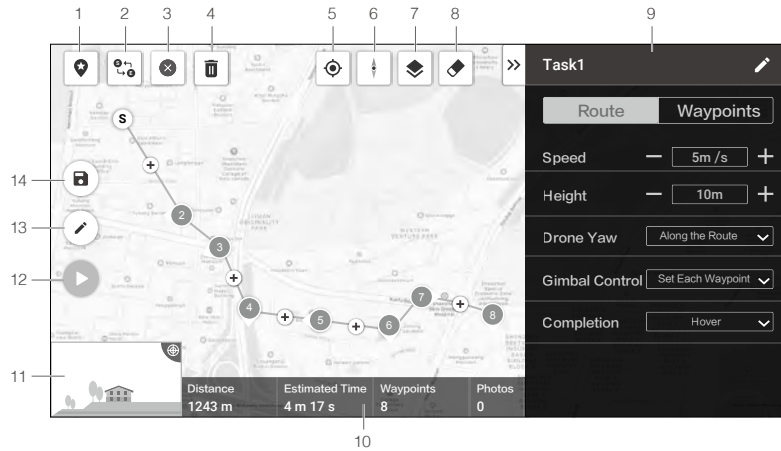

**🏠** : Tap this icon to return to the main menu.

## Mission Flight

Tap to enter the mission library. Set a waypoint flight path including up to 240 waypoints, define waypoint actions then start flying with a tap.



Tap on the map to add waypoints, then configure route and waypoints settings.

1. **Point of Interest (POI)**  
 : Tap to enable the POI function and a POI will be displayed on the map. Drag to adjust its position. When the POI function is enabled, the drone yaw can be set to center to POI so that the aircraft nose points at the POI during the mission. Tap this icon again to disable the POI function.
2. **Reverse Path**  
 : Tap it to swap the start and end points to reverse the flight path. "S" refers to the start point.
3. **Clear Waypoints**  
 : Tap to clear all the added waypoints.
4. **Delete Selected Waypoint**  
 : Tap to delete the selected waypoint.
5. **Location**  
 : Tap to center the map around the aircraft's location.
6. **Map Lock**  
 : Map rotation is locked by default. North is at the top. Tap the button to unlock rotation. Then users can adjust the map orientation by tapping and rotating two fingers on the map.
7. **Map Mode**  
 : Tap to switch between Standard and Satellite mode.
8. **Clear Screen**  
 : Tap to clear the flight path currently shown on the map.
9. **Parameter List**  
 Edit the mission name and configure Route and Waypoints settings in the list.

### Route

The settings are applied to the entire route, including aircraft speed, height, yaw, gimbal control, and completion action.

Drone Yaw:

- a. Along the route: The aircraft's nose is always aligned to the direction of the next two waypoints.
- b. Manual: Users manually control the aircraft heading using the control sticks.
- c. Set Each Waypoint: Set aircraft heading at each waypoint in "Waypoints" settings.
- d. Center to POI: This option will be displayed when a POI is added. The aircraft's nose is always pointing at the POI.

Gimbal Control:

- a. Manual: Users manually control the gimbal angle through the gimbal dial.
- b. Set Each Waypoint: Set gimbal pitch angle at each waypoint in "Waypoints" settings.

### Waypoints

The settings are applied to the selected waypoint, including aircraft height, yaw, rotation, gimbal pitch, and waypoint actions.

Select a waypoint and then set waypoint parameters. Tap "<" or ">" to switch to the previous or next waypoint.

Height:

- a. Follow Route: The aircraft height will be set according to "Route" settings.
- b. Defined: Input a custom height value.

Drone Yaw, Aircraft Rotation: These two options will be available to set the aircraft heading at the selected waypoint and the aircraft rotation direction when flying to the next waypoint if "Set Each Waypoint" is set for "Drone Yaw" in "Route" settings.

Gimbal Pitch: This option will be available to set the gimbal pitch angle if "Set Each Waypoint" is set for "Gimbal Control" in "Route" settings.

Actions:

Tap to enter the action list. Tap + to add the desired waypoint action and set its corresponding parameters. Tap and hold the icon ☰ on the left of the added action, drag it to re-order the actions. To delete the action, swipe it to the left and choose an option.

#### 10. Mission Information

Shows the flight length, estimated flight time, waypoint quantity, and photo quantity.

#### 11. Camera Preview

The real-time camera view will be shown here once the aircraft is connected.

#### 12. Perform

 : Tap the button and then check the settings and status of the aircraft in the pop-up checklist. Tap the "Start to Fly" button to perform the mission.

#### 13. Edit

 : If the path is not in edit mode, tap the icon to enter edit mode to edit the mission.

#### 14. Save

 : Tap to save current settings.

## Flight

Once pre-flight preparation is complete, it is recommended to use the flight simulator in DJI Assistant 2 for Matrice to hone your flight skills and practice flying safely. Ensure that all flights are carried out in an open area. It is important to understand basic flight guidelines for the safety of both you and those around you. Refer to the Disclaimer and Safety Guidelines for more information.

### Flight Environment Requirements

1. Do not use the aircraft in severe weather conditions. These include wind speeds exceeding 10 m/s, snow, rain, and fog.
2. When flying in open areas, tall and large metal structures may affect the accuracy of the onboard compass and GPS system.
3. Avoid obstacles, crowds, high voltage power lines, trees, and bodies of water.
4. Minimize interference by avoiding areas with elevated levels of electromagnetism, including base stations and radio transmission towers.
5. Aircraft and battery performance is subject to environmental factors such as air density and temperature. Be very careful when flying at high altitudes, as battery and aircraft performance may be affected.
6. The compass and GPS will not work in Polar Regions. The aircraft will have to auto switch to A-mode, using the Vision System for positioning.

### GEO (Geospatial Environment Online) System

#### Introduction

DJI's Geospatial Environment Online (GEO) System is a global information system committed to providing real-time airspace information within the scope of international laws and regulations. GEO provides flight information, flight times and location information to assist Unmanned Aerial Vehicle (UAV) users in making the best decisions related to their personal UAV use. It also includes a unique Regional Flight Restrictions feature which provides real-time flight safety and restriction updates and blocks UAVs from flying in restricted airspace. While safety and obeying air traffic control laws is a paramount concern, DJI recognizes the need for exceptions to be made under special circumstances. To meet this need, GEO also includes an Unlocking feature that enables users to unlock flights within restricted areas. Prior to making their flight, users must submit an unlock request based on the current level of restrictions in their area.

#### GEO Zones

DJI's GEO System designates safe flight locations, provides risk levels and safety concerns for individual flights, and offers restricted airspace information, which can be viewed by users in real time on the DJI Pilot app. The locations designated by GEO are called GEO Zones. GEO Zones are specific flight areas that are categorized by flight regulations and restrictions. GEO Zones that prohibit flight are implemented around locations such as airports, power plants, and prisons. They can also be temporarily implemented around major stadium events, forest fires, or other emergency situations. Certain GEO Zones do not prohibit flight but do trigger warnings informing users of potential risks. All restricted flight areas are referred to as GEO Zones, and are further divided into Warning Zones, Enhanced Warning Zones, Authorization Zones, Altitude Zones, and Restricted Zones. By default, GEO limits flights into or taking off within zones that may result in safety or security concerns. There is a GEO Zone Map, which contains comprehensive global GEO Zone information on the official DJI website: <https://www.dji.com/flysafe/geo-map>

## Flight

---

This section describes safe flight practices and flight restrictions.

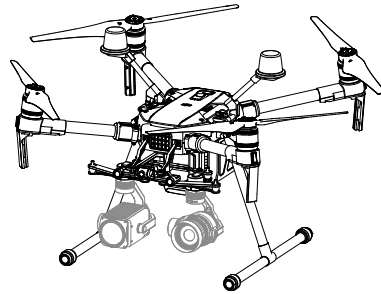

## Flight

Once pre-flight preparation is complete, it is recommended to use the flight simulator in DJI Assistant 2 for Matrice to hone your flight skills and practice flying safely. Ensure that all flights are carried out in an open area. It is important to understand basic flight guidelines for the safety of both you and those around you. Refer to the Disclaimer and Safety Guidelines for more information.

### Flight Environment Requirements

1. Do not use the aircraft in severe weather conditions. These include wind speeds exceeding 10 m/s, snow, rain, and fog.
2. When flying in open areas, tall and large metal structures may affect the accuracy of the onboard compass and GPS system.
3. Avoid obstacles, crowds, high voltage power lines, trees, and bodies of water.
4. Minimize interference by avoiding areas with elevated levels of electromagnetism, including base stations and radio transmission towers.
5. Aircraft and battery performance is subject to environmental factors such as air density and temperature. Be very careful when flying at high altitudes, as battery and aircraft performance may be affected.
6. The compass and GPS will not work in Polar Regions. The aircraft will have to auto switch to A-mode, using the Vision System for positioning.

### GEO (Geospatial Environment Online) System

#### Introduction

DJI's Geospatial Environment Online (GEO) System is a global information system committed to providing real-time airspace information within the scope of international laws and regulations. GEO provides flight information, flight times and location information to assist Unmanned Aerial Vehicle (UAV) users in making the best decisions related to their personal UAV use. It also includes a unique Regional Flight Restrictions feature which provides real-time flight safety and restriction updates and blocks UAVs from flying in restricted airspace. While safety and obeying air traffic control laws is a paramount concern, DJI recognizes the need for exceptions to be made under special circumstances. To meet this need, GEO also includes an Unlocking feature that enables users to unlock flights within restricted areas. Prior to making their flight, users must submit an unlock request based on the current level of restrictions in their area.

#### GEO Zones

DJI's GEO System designates safe flight locations, provides risk levels and safety concerns for individual flights, and offers restricted airspace information, which can be viewed by users in real time on the DJI Pilot app. The locations designated by GEO are called GEO Zones. GEO Zones are specific flight areas that are categorized by flight regulations and restrictions. GEO Zones that prohibit flight are implemented around locations such as airports, power plants, and prisons. They can also be temporarily implemented around major stadium events, forest fires, or other emergency situations. Certain GEO Zones do not prohibit flight but do trigger warnings informing users of potential risks. All restricted flight areas are referred to as GEO Zones, and are further divided into Warning Zones, Enhanced Warning Zones, Authorization Zones, Altitude Zones, and Restricted Zones. By default, GEO limits flights into or taking off within zones that may result in safety or security concerns.

The GEO System is for advisory purposes only. Individual users are responsible for checking official sources and determining which laws or regulations may apply to their flight. In some instances, DJI has selected widely-recommended general parameters (such as a 1.5-mile radius at airports) without making any determination as to whether these guidelines match regulations that apply to specific users.

#### GEO Zone Definitions

**Warning Zones:** Users receive a warning message with information relevant to their flight.

**Enhanced Warning Zones:** Users receive a prompt from the GEO System at the time of flight. They are required to submit an unlock request to fly in the zone, for which they must confirm their flight path.

**Authorization Zones:** Users receive a warning message and the flight is prohibited by default. Authorization Zones can be unlocked by authorized users with a DJI-verified account. Self-Unlocking privileges must be applied for online.

**Altitude Zones:** Flights are limited to a specific altitude.

**Restricted Zones:** Flights are completely prohibited. UAVs cannot fly in these zones. If you have obtained permission to fly in a Restricted Zone, please go to <https://www.dji.com/flysafe> or contact [flysafe@dji.com](mailto:flysafe@dji.com) to unlock the zone.

DJI GEO Zones aim to ensure the user's flight safety, but it cannot be guaranteed to be in full compliance with local laws and regulations. Users should check local laws, regulations, and regulatory requirements before each flight and are responsible for the flight safety.

All intelligent flight features will be affected when DJI aircraft fly nearby or into GEO Zones. Such interference includes, but is not limited to, decreased speed, takeoff failure, and flight termination.

## Flight Restrictions

### Introduction

UAV operators should abide by all flight regulations established by the relevant government and regulatory agencies, including the ICAO and the FAA. For safety reasons, flights are restricted by default, which helps users operate DJI products safely and legally. Flight restrictions include altitude and distance limits, and GEO Zones.

When Global Navigation Satellite Service (GNSS) is available, altitude limits, distance limits, and GEO Zones are all taken into account to ensure flight safety. Otherwise, only altitude limits take effect.

### Maximum Altitude & Radius Restrictions

Maximum flight altitude restricts an aircraft's flight altitude, while maximum radius restricts its distance. These limits can be set using the DJI Pilot app.

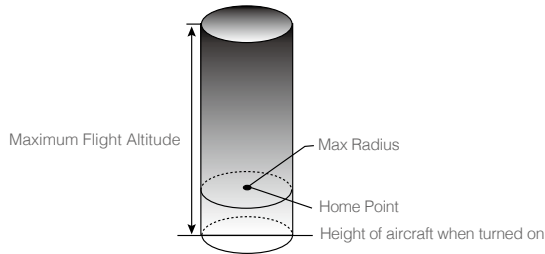

Strong GPS Signal		
Restriction	Description	DJI Pilot App Message
Max Altitude	Aircraft's altitude cannot exceed the specified value.	Maximum Flight Altitude reached. Adjust your altitude using FC Settings if required.
Max Radius	Flight distance cannot exceed the specified value.	Maximum Flight Distance reached. Adjust your distance using FC Settings if required.

Weak GPS Signal		
Restriction	Description	DJI Pilot App Message
Max Altitude	Altitude is restricted to 26 ft (8 m) when GPS signal is weak and the Vision System is activated. Altitude is restricted to 98 ft (30 m) when GPS signal is weak and the Vision System is deactivated.	Maximum Flight Altitude reached. Adjust your altitude using MC Settings if required.
Max Radius	No limit.	N/A

- ⚠
- When an aircraft exceeds a specified limit, the pilot can still control the aircraft but it will be unable to fly any farther.
  - When an aircraft exceeds the max radius it automatically flies back within range when GPS signal is strong.
  - For safety reasons, do not fly near airports, highways, railway stations, railway lines, city centers, or other sensitive areas. Only fly aircraft in areas that are within your direct line of sight.

GEO Zone Flight Restrictions

GEO Zone	Description
Restricted Zone	Takeoff: The aircraft's motors cannot be started.
	In-flight: When GPS signal changes from weak to strong, DJI Pilot starts a 20-second countdown. Once the countdown is over, the aircraft immediately lands in semi-automatic descent mode and turns off its motors after landing.
	In-flight: When the aircraft approaches the boundary of the Restricted Zone, it automatically decelerates and hovers.
Authorization Zone	Takeoff: The aircraft's motors cannot be started. Takeoff is only available after submitting an unlock request with the user's phone number.
	In-flight: When GPS signal changes from weak to strong, DJI Pilot starts a 20-second countdown. Once the countdown is over, the aircraft immediately lands in semi-automatic descent mode and turns off its motors after landing.
Enhanced Warning Zone	The aircraft flies normally but the user is required to confirm the flight path.
Warning Zone	The aircraft flies normally but the user receives warning messages.
Altitude Zone	When GPS signal is strong, the aircraft cannot exceed the specified altitude. In-flight: When GPS signal changes from weak to strong, the aircraft will descend and hover below the altitude limit.
	When the GPS signal is strong, the aircraft approaches the boundary of the Altitude Zone. If it is higher than the altitude limit, the aircraft decelerates and hovers in place.
	When the GPS signal changes from weak to strong, DJI Pilot app starts a 20-second countdown. Once the countdown is over, the aircraft will descend and hover below the altitude limit.
Free Zone	The aircraft flies normally with no restrictions.

 Semi-Automatic Descent: All stick commands are available except the throttle command and RTH button during descent and landing. The aircraft's motors turn off automatically after landing. It is recommended to fly the aircraft to a safe location to land immediately.

## GEO Unlocking

Due to differing laws and regulations between countries and regions, and differing flight restrictions between GEO Zones, DJI provides users with two methods for unlocking GEO Zones: Self-Unlocking and Custom Unlocking.

Self-Unlocking is used for Authorization Zones, where the user is required to submit an unlock request by authenticating their phone number for a registered DJI account. This feature is only available in certain countries. Users can choose whether to submit their unlock request via the website at <https://www.dji.com/flysafe> (Scheduled Self-Unlocking), or through the DJI Pilot app (Live Self-Unlocking).

Custom Unlocking is based on special requirements for individual users. It sets a special flight area that users can unlock by providing flight permission files according to their specific GEO Zone and other requirements. It is available in all countries and can be applied for on the website: <https://www.dji.com/flysafe>.

## Preflight Checklist

1. Remote controller, Intelligent Flight Battery, and display device are fully charged.
2. Frame arms and D-RTK antennas (for the M210 RTK V2) are unfolded and locked firmly, landing gears are mounted firmly, and propellers and GPS kit (if in use) are mounted correctly.
3. All the devices' firmware is up-to-date.
4. microSD card has been inserted, if necessary.
5. Gimbal is functioning normally.
6. Motors can start and are functioning normally.
7. The DJI Pilot app is successfully connected to the aircraft.
8. Ensure that the sensors for the Vision and Infrared Sensing Systems are clean.

## Calibrating the Compass

Only calibrate the compass when the DJI Pilot app or the status indicator prompts you to do so. Observe the following rules when calibrating your compass:

- 💡 • DO NOT calibrate your compass where there is a chance of strong magnetic interference, such as near magnets, parking structures, or steel reinforcements underground.
- DO NOT carry ferromagnetic materials with you during calibration such as cellular phones.
- The DJI Pilot app will notify you if the compass is affected by strong interference after calibration is complete. Follow the prompts to resolve the compass issue.

## Calibration Procedures

Choose an open area to carry out the following procedures.

1. Tap the Aircraft Status Bar in the app and select Calibrate, then follow the on-screen instructions.
2. Hold the aircraft horizontally and rotate it 360 degrees. The Aircraft Status Indicators will go solid green.

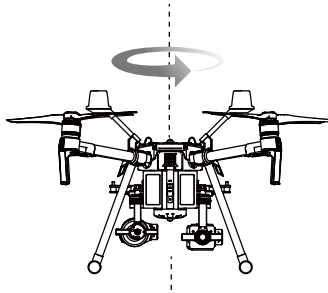

3. Hold the aircraft vertically, with the nose pointing downward, and rotate it 360 degrees around the center axis. Re-calibrate the aircraft if the aircraft status indicators blink red.

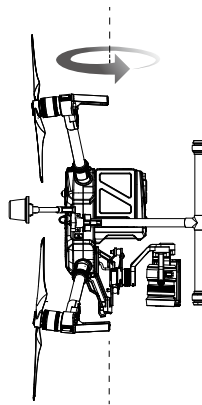

---

 If the Aircraft Status Indicator blinks red and yellow after the calibration procedure, move your aircraft to a different location and try again.

-  • DO NOT calibrate the compass near metal objects such as a metal bridge, cars, scaffolding.
- If the aircraft status indicators are blinking red and yellow alternately after placing the aircraft on the ground, the compass has detected magnetic interference. Please change your location.
-

## Starting/Stopping the Motors

### Starting Motors

The Combination Stick Command (CSC) is used to start the motors. Push both sticks to the bottom inner or outer corners to start the motors. Once the motors start spinning, release both sticks simultaneously.



### Stopping the Motors

There are two ways to stop the motors:

1. When aircraft has landed, push the left stick down ①, then conduct the same CSC that was used to start the motors, as shown above ②. Motors will stop immediately. Release both sticks once motors stop.
2. When the aircraft has landed, push and hold the left stick down. The motors will stop after three seconds.

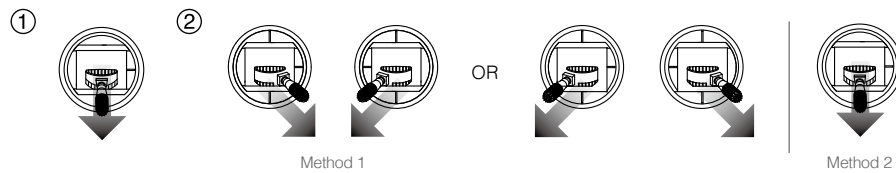

## Stop the Motor Mid-flight

To stop the motors mid-flight, press the RTH button while simultaneously pulling the left stick to the bottom inner corner. **Stop motors mid-flight will cause the aircraft to crash. The motor can only be stopped mid-flight when the flight controller detects critical error.**

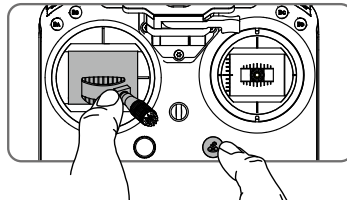

## Flight Test

### Takeoff/Landing Procedures

1. Place the aircraft in an open, flat area with the battery level indicators facing towards you.
2. Turn on the remote controller, then turn on the Intelligent Flight Battery.
3. Launch DJI Pilot and enter the Camera View.
4. Wait until the Aircraft Status Indicators blink green (GPS) or blink green and blue alternately (RTK, for the M210 RTK V2 only).
5. If the Intelligent Flight Battery temperature is low, use the self-heating function to heat the batteries to ensure the temperature is suitable for the aircraft to take off.
6. Turn on the motors using CSC and push the left stick up slowly to take off.
7. To land, hover over a level surface and gently pull down on the left stick to descend.
8. After landing, execute the CSC command or hold the left stick at its lowest position until the motors stop.
9. Turn off the Intelligent Flight Battery first, then the remote controller.



- When the Aircraft Status Indicators blink yellow rapidly during flight, the aircraft has entered Failsafe mode.
- A low battery level warning is indicated by the Aircraft Status Indicators blinking red slowly or rapidly during flight.
- Watch our video tutorials for more flight information.

### Video Suggestions and Tips

1. Go through the full pre-flight checklist before each flight.
2. Select the desired gimbal operation mode in the DJI Pilot app.
3. Only shoot video when flying in P-mode.
4. Always fly in good weather and avoid flying in rain or heavy wind.
5. Choose the camera settings that suit your needs. Settings include photo format and exposure compensation.
6. Perform flight tests to establish flight routes and preview scenes.
7. Push the control sticks gently to keep the aircraft's movement smooth and stable.



- It is important to understand basic flight guidelines for the safety of both you and those around you.
- Refer to the Disclaimer and Safety Guidelines for more information.

### IP43 Protection Rating

Under stable laboratory conditions, the Matrice 200 Series V2 achieves an IP43 protection rating by IEC60529 standards when equipped with TB55 Intelligent Flight Batteries. However, this protection rating is not permanent and may reduce over time after long-term use.

- DO NOT fly when the amount of rainfall exceeds 10 mm/h.
- DO NOT fold the frame arms in the rain.
- The angle of inclination of the aircraft body and the ground should not exceed  $\pm 60^\circ$  when fly the aircraft in rainy days.

- Make sure the battery ports, battery compartment ports, battery surfaces, and battery compartment surfaces are dry before inserting the batteries.
- Make sure the battery ports and battery surfaces are free from any liquid before charging the batteries.
- Before packing the aircraft into the carrying case, ensure that it is free from any liquid by wiping it carefully.
- Product warranty does not cover water damage.

The aircraft does not achieve IP43 protection rating in the following circumstances:

- Folded frame arms.
- Turn the aircraft upside down.
- You use batteries other than the M200 Series V2's TB55 Intelligent Flight Batteries.
- The cover for the ports and buttons on the rear of the aircraft are not attached correctly.
- The external GPS module is in use.
- The weatherproofing top shell plug is not firmly attached to the top shell.
- The microSD card slot cover is not firmly attached.
- The aircraft is broken due to various reasons, such as broken aircraft shell, failure of the waterproof adhesive, etc.

## Appendix

---

## Appendix

Specifications	
<b>Aircraft (M210 V2 / M210 RTK V2)</b>	
Dimensions	M210 V2: Unfolded, propellers and landing gears included, 883×886×398 mm Folded, propellers and landing gears excluded, 722×282×242 mm M210 RTK V2: Unfolded, propellers and landing gears included, 883×886×427 mm Folded, propellers and landing gears excluded, 722×282×242 mm
Diagonal Wheelbase	643 mm
Weight	M210 V2: Approx. 4.8 kg (with two TB55 batteries); M210 RTK V2: Approx. 4.91 kg (with two TB55 batteries)
Max Takeoff Weight	6.14 kg
Max Payload	M210 V2: 1.34 kg; M210 RTK V2: 1.23 kg
Operating Frequency	2.4000-2.4835 GHz; 5.725-5.850 GHz
EIRP	2.4 GHz: ≤ 26 dBm (NCC/FCC); ≤ 20 dBm (CE/MIC); ≤ 20 dBm (SRRC) 5.8 GHz: ≤ 26 dBm (NCC/FCC); ≤ 14 dBm (CE); ≤ 26 dBm (SRRC)
Hovering Accuracy (P-mode with GPS)	Vertical: ±1.64 feet (±0.5 m) or ±0.33 feet (±0.1 m, Downward Vision System enabled) Horizontal: ±4.92 feet (±1.5 m) or ±0.98 feet (±0.3 m, Downward Vision System enabled)
Hovering Accuracy (D-RTK, M210 RTK V2)	Vertical: ±0.33 feet (±0.1 m); Horizontal: ±0.33 feet (±0.1 m)
Max Angular Velocity	Pitch: 300°/s, Yaw: 120°/s
Max Pitch Angle (Dual Downward Gimbal/Single Upward Gimbal)	S-mode: 30°; P-mode: 30° (Forward Vision System enabled: 25°); A-mode: 30°
Max Pitch Angle (Single Downward Gimbal)	S-mode: 35°; P-mode: 30° (Forward Vision System enabled: 25°); A-mode: 30°
Max Ascent Speed	16.4 ft/s (5 m/s)
Max Descent Speed (vertical)	9.8 ft/s (3 m/s)
Max Speed (Dual Downward Gimbal/Single Upward Gimbal)	S-mode/A-mode: 73.8 kph (45.9 mph); P-mode: 61.2 kph (38 mph)
Max Speed (Single Downward Gimbal)	S-mode/A-mode: 81 kph (50.3 mph); P-mode: 61.2 kph (38 mph)
Max Service Ceiling Above Sea Level	9842 feet (3000 m, with 1760S propellers)
Max Wind Resistance	39.4 ft/s (12 m/s)
Max Flight Time (with two TB55 batteries)	M210 V2: 34 min (no payload), 24 min (takeoff weight: 6.14 kg) M210 RTK V2: 33 min (no payload), 24 min (takeoff weight: 6.14 kg)
Motor Model	DJI 3515
Propeller Model	1760S
Supported DJI Gimbals	Zenmuse X4S/X5S/X7/XT/XT2/Z30
Supported Gimbal Configurations	Single Downward Gimbal (connected to Gimbal Connector I), Dual Downward Gimbals, Single Upward Gimbal
Ingress Protection Rating	IP43

GNSS	M210 V2: GPS+GLONASS; M210 RTK V2: GPS+GLONASS+BeiDou+Galileo
Operating Temperature	-4° to 122° F (-20° to 50° C)
<b>Beacons</b>	
Power	Avg. 0.6 W
Luminous Intensity	Min. Angle: 55 cd; light intensity: 157 cd
Max. Visible Distance	5000 m (with good air quality and high visibility)
<b>Remote Controller (GL900A)</b>	
Operating Frequency	2.4000-2.4835 GHz; 5.725-5.850 GHz
Max Transmitting Distance (unobstructed, free of interference)	NCC/FCC: 5 mi (8 km); CE/MIC: 3.1 mi (5 km); SRRC: 3.1 mi (5 km)
EIRP	2.4 GHz: ≤ 26 dBm (NCC/FCC); ≤ 20 dBm (CE/MIC); ≤ 20 dBm (SRRC) 5.8 GHz: ≤ 26 dBm (NCC/FCC); ≤ 14 dBm (CE); ≤ 26 dBm (SRRC)
Video Output Ports	USB, HDMI, SDI
Power Supply	Extended Intelligent Battery (Model: WB37-4920mAh-7.6V)
Charging	DJI charger or DJI charging hub
Output Power (max)	13 W (Without supplying power to monitor)
USB Power Supply	1 A ≈ 5.2 V (max)
CrystalSky Monitor	DJI CrystalSky 7.85inch, Resolution: 2048×1536; Brightness: 2000 cd/m <sup>2</sup> ; Operating System: Android 5.1; Storage: ROM 128GB
Operating Temperature	-4° to 122° F (-20° to 50° C)
Optimal Storage Temperature	72° to 86° F (22° to 30° C)
Charging Temperature	32° to 104° F (0° to 40° C)
<b>Downward Vision System</b>	
Velocity Range	<32.8 ft/s (10 m/s) at the height of 6.56 feet (2 m)
Altitude Range	<32.8 feet (10 m)
Operating Range	<32.8 feet (10 m)
Operating Environment	Surfaces with clear patterns and adequate lighting (>15 lux)
Ultrasonic Sensor Operating Range	0.33-16.4 feet (0.1-5 m)
Ultrasonic Sensor Operating Environment	Non-absorbing material, rigid surfaces (thick indoor carpeting will adversely affect performance)
<b>Forward Vision System</b>	
Obstacle Sensing Range	2.3-98.4 feet (0.7-30 m)
FOV	Horizontal: 60°; Vertical: 54°
Operating Environment	Surfaces with clear patterns and adequate lighting (> 15 lux)
<b>Upward Infrared Sensing System</b>	
Obstacle Sensing Range	0-16.4 feet (0-5 m)
FOV	±5°
Operating Environment	Large, diffuse, and reflective obstacles (reflectivity >10%)
<b>Intelligent Flight Battery (TB55-7660mAh-22.8V)</b>	
Capacity	7660 mAh

Voltage	22.8 V
Battery Type	LiPo 6S
Energy	174.6 Wh
Net Weight (Single One)	Approx. 885 g
Operating Temperature	-4° to 122° F (-20° to 50° C)
Optimal Storage Temperature	72° to 86° F (22° to 30° C)
Charging Temperature	41° to 104° F (5° to 40° C)
Max Charging Power	180 W
<b>Charger (IN2C180)</b>	
Voltage	26.1 V
Rated Power	180 W
<b>Charging Hub (IN2CH)</b>	
Input Voltage	26.1 V
Input Current	6.9 A

## Firmware Update

Use the DJI Pilot app or the DJI Assistant 2 for Matrice to update the remote controller, aircraft and other connected DJI devices.

For the Zenmuse X5S, X4S and X7, the aircraft and gimbal firmware will be updated simultaneously via DJI Assistant 2 for Matrice or the DJI Pilot app.

For the Zenmuse Z30, XT and XT2, only aircraft firmware can be updated via DJI Assistant 2 for Matrice or the DJI Pilot app. Gimbal firmware must be updated via a microSD card.

### Using DJI Pilot

1. Ensure that there is good connection between the aircraft and remote controller and other DJI devices used with the aircraft such as a D-RTK 2 Mobile Station for Matrice Series, and that all the devices are powered on.
2. Go to the app. A prompt will appear if new firmware is available for download. Follow the on-screen instructions to update the firmware. Make sure to connect to the Internet when downloading the firmware.

### Using DJI Assistant 2 for Matrice

Connect the remote controller to the software and then run a firmware update for all the connected DJI devices. Users can also connect each device to the software to update its own firmware.

1. Power on the device and connect it to the software.
2. Click the corresponding device name and then the firmware update tag.
3. Select the firmware version required. Make sure to connect to the Internet when downloading the firmware.
4. Restart the device after the firmware update is complete.

- ⚠
- The battery firmware is included in the aircraft firmware. Be sure to update all the batteries' firmware.
  - The firmware update will take around 15 minutes. It is normal that the gimbal will go limp, the aircraft status indicator blinks abnormally when the aircraft reboots. Wait patiently until the update is complete.
  - During an update, the aircraft will sound a quick single beep continuously. The warning sound will then alternate between a longer beep and a quick double beep once the update is complete. Restart the aircraft after the firmware update is complete.
  - If the warning sound turns into a long beep, retry the update.
  - The battery level should be above 30% for the firmware update process.
  - When using DJI Pilot to update, you may disconnect the aircraft and the mobile device once the update is more than 30% completed. No Internet connection is required.

### Using the Zenmuse XT Gimbal and Camera

The Zenmuse XT Gimbal Adapter is required when mounting the Zenmuse XT gimbal to the aircraft.

1. Attach the Zenmuse XT gimbal adapter onto the Zenmuse XT gimbal.



2. Mount the Zenmuse XT onto the aircraft by securing the gimbal adapter.

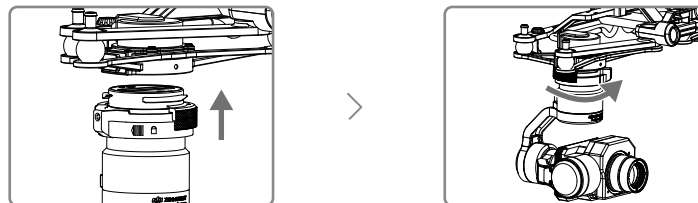

## Dual Downward Gimbals

### Using the Dual Downward Gimbals

All Zenmuse X5S, X4S, XT, X7, XT2, and Z30 gimbals are supported. You can mount them to the Gimbal Connector I and Gimbal Connector II as shown below:

Gimbal Connector II	Gimbal Connector I
Zenmuse XT	Zenmuse X4S/X5S/X7/Z30/XT2
Zenmuse Z30	Zenmuse X4S/X5S/X7/XT/XT2

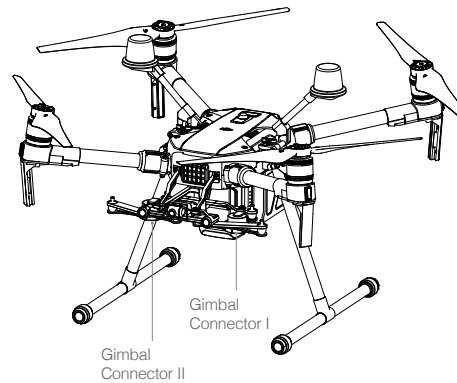

Please note that Gimbal Connector II can be mounted with the Zenmuse XT and Z30 only. Gimbal Connector I and Gimbal Connector II cannot be mounted with two of the same Zenmuse gimbals. Gimbal Connector I's camera view will show on the main interface in the DJI Pilot app, while Gimbal Connector II's camera view will show on the assistant interface. You can switch between them.

- ⚠ • When using the Zenmuse Z30 and X7 cameras together, they might obstruct each other's motion at certain angles.
- If using only one camera be sure to install the gimbal and camera on Gimbal Connector I and not on Gimbal Connector II.

### Using the Upward Gimbal and GPS Kit

The M210 V2/M210 RTK V2 supports upward gimbal. The GPS kit is required to obtain better GPS signal when an upward gimbal is used on the M210 V2 aircraft. Refer to the manuals for the Single Upward Gimbal Connector and GPS Kit on installation and usage.

- ⚠ • The GPS kit has an IP43 ingress protection. However, the aircraft will not retain its IP43 rating if the GPS kit is installed. Users can customize a waterproof rear port cover to ensure ingress protection.
- The M210 V2/M210 RTK V2 supports the simultaneous use of an upward gimbal and a downward gimbal. The upward gimbal should be connected to Gimbal Connector I only.

### GPS Kit Indicator Descriptions

Blinking Blue	Self-checking, or positioning finished but not used.
Blinking Green Slowly	Positioning finished and data from GPS kit used.
Red	Error

Carrying Box Descriptions

- 1. Landing Gear × 2
- 2. Propeller Pair × 4

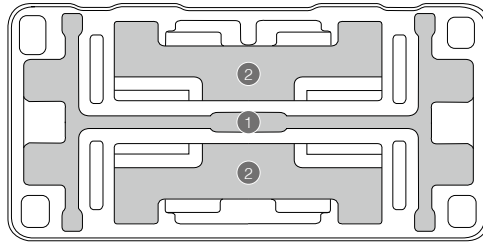

- 1. Aircraft
- 2. Remote Controller
- 3. CrystalSky Monitor/iPad
- 4. Intelligent Flight Battery
- 5. Wb37 Intelligent Battery
- 6. In2ch Charging Hub
- 7. WCH2 Charging Hub
- 8. Battery Charger
- 9. Gimbal and Camera (X5S/Z30)
- 10. Mobile Device Holder
- 11. Remote Controller Strap/Intelligent Flight Battery
- 12. Power Cable/Intelligent Flight Battery
- 13. Accessory Box/Intelligent Flight Battery

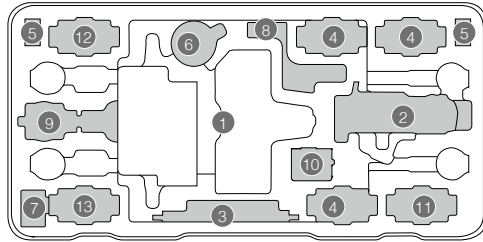

DJI incorporates HDMI™ technology.  
The terms HDMI and HDMI High-Definition Multimedia Interface, and the HDMI Logo are trademarks or registered trademarks of HDMI Licensing LLC in the United States and other countries.