



INSTRUMENTS

SDM-2009 Docking Station Standalone Configuration Operator's Manual

Part Number: 71-0261RK

Revision: C

Released: 10/25/19

Warranty

RKI Instruments, Inc. warrants gas alarm equipment sold by us to be free from defects in materials and workmanship, and performance for a period of one year from date of shipment from RKI Instruments, Inc. Any parts found defective within that period will be repaired or replaced, at our option, free of charge. This warranty does not apply to those items which by their nature are subject to deterioration or consumption in normal service, and which must be cleaned, repaired, or replaced on a routine basis. Examples of such items are:

Absorbent cartridges

Batteries

Pump diaphragms and valves

Filter elements

Fuses

Warranty is voided by abuse including mechanical damage, alteration, rough handling, or repairs procedures not in accordance with the instruction manual. This warranty indicates the full extent of our liability, and we are not responsible for removal or replacement costs, local repair costs, transportation costs, or contingent expenses incurred without our prior approval.

THIS WARRANTY IS EXPRESSLY IN LIEU OF ANY AND ALL OTHER WARRANTIES AND REPRESENTATIONS, EXPRESSED OR IMPLIED, AND ALL OTHER OBLIGATIONS OR LIABILITIES ON THE PART OF RKI INSTRUMENTS, INC. INCLUDING BUT NOT LIMITED TO THE WARRANTY OF MERCHANTABILITY OR FITNESS FOR A PARTICULAR PURPOSE. IN NO EVENT SHALL RKI INSTRUMENTS, INC. BE LIABLE FOR INDIRECT, INCIDENTAL, OR CONSEQUENTIAL LOSS OR DAMAGE OF ANY KIND CONNECTED WITH THE USE OF ITS PRODUCTS OR FAILURE OF ITS PRODUCTS TO FUNCTION OR OPERATE PROPERLY.

This warranty covers instruments and parts sold to users only by authorized distributors, dealers, and representatives as appointed by RKI Instruments, Inc.

We do not assume indemnification for any accident or damage caused by the operation of this gas monitor and our warranty is limited to replacement of parts or our complete goods.

Table of Contents

Chapter 1: Introduction	5
Overview	5
About the SDM-2009	5
System Requirements	6
Specifications	7
About This Manual	8
Cautions & Safety Information	8
Chapter 2: Description	9
Overview	9
AC Adapter	9
USB Cable	10
Air Filter and Sample Tubing	10
Check Valve	11
T-Fittings	11
Instrument Cradle	12
Back Panel	13
<i>Power Jack</i>	<i>13</i>
<i>Sample Fittings</i>	<i>13</i>
<i>PC Connection</i>	<i>13</i>
Control Panel	14
Front Panel	16
Chapter 3: Preparing to Use the SDM-2009	17
Overview	17
Hardware Assembly	17
<i>Assembling a Manifold for Multiple SDM-03s</i>	<i>18</i>
Setting the Operational Parameters in Edit Mode	22
<i>Bump Test & Calibration Parameters</i>	<i>22</i>
<i>Turning on the SDM-2009 with an Instrument</i>	<i>24</i>
<i>Setting the Bump Test Parameters</i>	<i>26</i>
<i>Setting the Calibration Parameters</i>	<i>28</i>

Connecting Calibration Gas	30
Installing the Single Module Data Viewer Software	31
Chapter 4: Operation	32
Overview.....	32
Bump Testing a GX-2009.....	32
Calibrating a GX-2009	37
Troubleshooting	42
Charging an Instrument in a Docking Station.....	44
<i>Recharging the Batteries After Performing a Bump Test or Calibration</i>	<i>44</i>
<i>Recharging the Batteries Without Performing Any Operations</i>	<i>44</i>
<i>Batteries Too Drained for Standalone Operation.....</i>	<i>45</i>
Calibration and Bump Test Records	46
<i>Available Memory in the SDM-2009</i>	<i>46</i>
<i>Copying Calibration and Bump Test Records.....</i>	<i>46</i>
<i>Clearing the SDM-2009's Memory.....</i>	<i>47</i>
<i>Bump Test and Calibration Record Files</i>	<i>47</i>
<i>Bump Testing or Calibrating and Saving Files to a Flash Drive</i>	
<i>Multiple Times in One Day.....</i>	<i>48</i>
Chapter 5: Single Module Data Viewer Program	49
Overview.....	49
Launching the Single Module Data Viewer Program.....	49
<i>Data Viewing Window.....</i>	<i>50</i>
Using the Single Module Data Viewer Program.....	50
<i>Importing Files Into the Database</i>	<i>51</i>
<i>Organizing the Data</i>	<i>52</i>
<i>Viewing the Data.....</i>	<i>53</i>
<i>Deleting Data</i>	<i>57</i>
<i>Changing the Password</i>	<i>58</i>
<i>Exiting the Program</i>	<i>59</i>
Chapter 6: Spare Parts List	60

CAUTION: *Read and understand this manual before using the SDM-2009. Also read and understand the GX-2009 Operator's Manual.*

Chapter 1: Introduction

Overview

This chapter briefly describes the SDM-2009 Docking Station and the Single Module Data Viewer Program. This chapter also describes the *SDM-2009 Docking Station Standalone Operation Operator's Manual* (this document). Table 1 at the end of this chapter lists the SDM-2009's specifications.

About the SDM-2009

The SDM-2009 Docking Station is an advanced, reliable system that provides charging, calibration, bump testing, and calibration and bump test records for the GX-2009 portable gas monitor. It is designed to save the calibration and bump test records to a USB flash drive (standalone functionality) or to be connected directly to a computer (PC controlled functionality). If calibration and bump test records are stored to a USB flash drive while operating in the standalone configuration, the Single Module Data Viewer Program can then be used with a Windows-based personal computer to retrieve calibration and bump test data files from the USB flash drive or from the computer's hard drive if the files have been transferred to the hard drive from the flash drive. If you are using the PC Controller Program while operating in the PC controlled configuration, you may retrieve instrument data, bump test, and calibrate up to 10 instruments at once. Instrument information and data for each instrument can be viewed directly using the PC Controller Program and can be printed from the PC Controller Program. For instructions to use the SDM-2009 with the PC Controller Program, see the *SDM-2009 Docking Station PC Controlled Configuration Operator's Manual*.

The purpose of this manual is to explain how to set up and use the SDM-2009 in Standalone configuration. It also explains how to use the Single Module Data Viewer Program. You will learn how to:

- install and launch the Single Module Data Viewer Program
- prepare the SDM-2009 for use
- perform a bump test
- perform a calibration
- save calibration and bump test records to a USB flash drive
- view, print, and export calibration and bump test records
- use the SDM-2009 to charge an instrument

CAUTION: *The GX-2009 detects oxygen deficiency and elevated levels of oxygen, combustible gases, carbon monoxide, and hydrogen sulfide, all of which can be dangerous or life threatening. When using the GX-2009, you must follow the instructions and warnings in the GX-2009 Operator's Manual to assure proper and safe operation of the instrument and to minimize the risk of personal injury.*

CAUTION: *The operator of this instrument is advised that if the equipment is used in a manner not specified in this manual, the protection provided by the equipment may be impaired.*

System Requirements

To use the Single Module Data Viewer Software, your personal computer must meet the following requirements:

- **Operating Systems:** Windows[®] XP, Windows[®] Vista, Windows[®] 7, Windows[®] 8, or Windows[®] 10.
- **Processor:** IBM[®] compatible PC running Pentium[®] 2 processor or equivalent minimum
- **Memory:** 32 MB RAM minimum
- **Hard Disk Space:** 32 MB minimum
- **Available USB port**

Specifications

Table 1: SDM-2009 Specifications

Input Power	12 VDC NOTE: AC Adapter with 100 - 240 VAC, 50/60 Hz, 0.6A input and 12 VDC, 1.2A output provided as standard.
Environmental Conditions	<ul style="list-style-type: none"> • For Indoor Use Only • -10° C to 40° C, below 80% Relative Humidity, Non-Condensing
Applicable Instruments	GX-2009
Memory Capacity	64 KB
Maximum Record Size	256 bytes
Maximum Number of Records Saved	200
Number of Calibration Gas Cylinders	One calibration gas cylinder per bump test or calibration
Standard Accessories	<ul style="list-style-type: none"> • AC Adapter • USB Flash Drive • Single Module Data Viewer Program* • SDM-GX Docking Station PC Controller Program* • Inlet Air Filter • Instruction Manual • 10 Foot Long Exhaust Tube • One 3 Foot Long Tube for GAS Fitting • 10 Foot Long 3/16 Inch Tube for GAS manifolding • 2 T-Fittings • Check Valve • USB Cable, Type A to Type B
* Not sent with SDM-2009.	

About this Manual

The *SDM-2009 Docking Station Standalone Configuration Operator's Manual* uses the following conventions for notes, cautions, and warnings.

NOTE: Describes additional or critical information.

CAUTION: Describes potential damage to equipment.

WARNING: Describes potential danger that can result in injury or death.

Cautions & Safety Information

- Use only polyurethane sample tubing with the SDM-2009. Consult RKI Instruments, Inc. for other materials.
- Do not subject the SDM-2009 to infrared or intense light. This may cause communication errors.
- Do not expose the SDM-2009 to water.
- Do not subject the SDM-2009 to any hard impact.

Chapter 2: Description

Overview

This section describes the SDM-2009 docking station. It is designed to be used on a table top and consists of the AC adapter, Type A to Type B USB cable, air filter, check valve, 2 plastic T-fittings, sample tubing, instrument cradle, back panel, control panel, status LEDs, and 2 USB ports.

AC Adapter

Single-Port AC Adapter

The single-port AC adapter is a wall plug style adapter with a 5 foot cable. The end of the cable has a plug that connects to the power jack on the SDM-2009's back panel. The AC adapter is rated 100 - 240 VAC input, 12 VDC 1.2 A output.

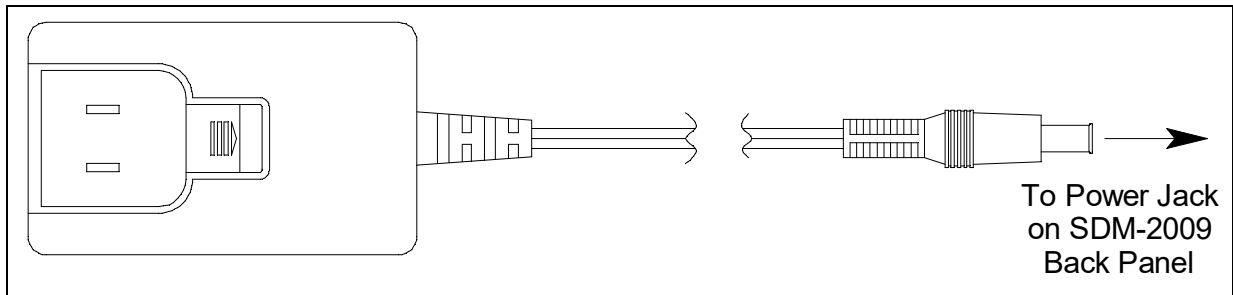

Figure 1: Single-Port AC Adapter

4-Port AC Adapter

The 4-port AC adapter is a wall plug style adapter with four 5-foot cables. The end of each cable has a plug that connects to the power jack on the SDM-2009's back panel. The AC adapter is rated 100 - 240 VAC input, 12 VDC 2.0 A output.

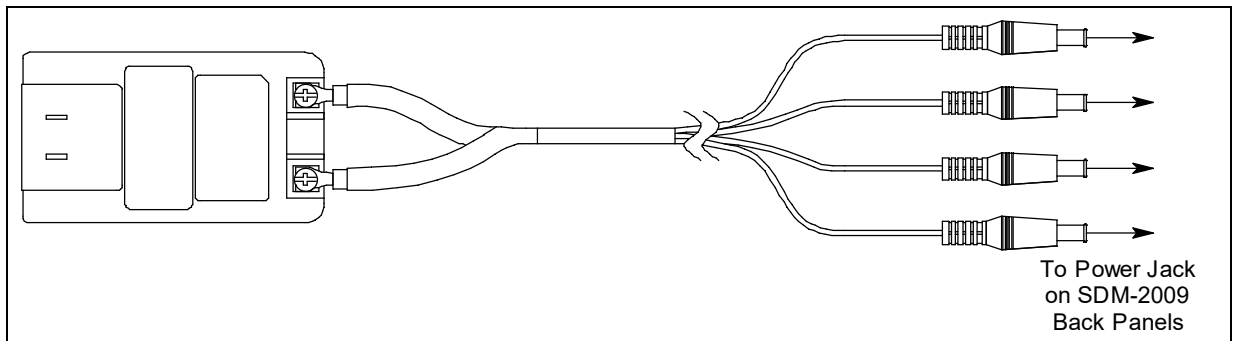

Figure 2: 4-Port AC Adapter

USB Cable

A Type A to Type B USB cable is provided with the docking station. It is only for use with the PC Controlled configuration. It is not used in the Standalone configuration.

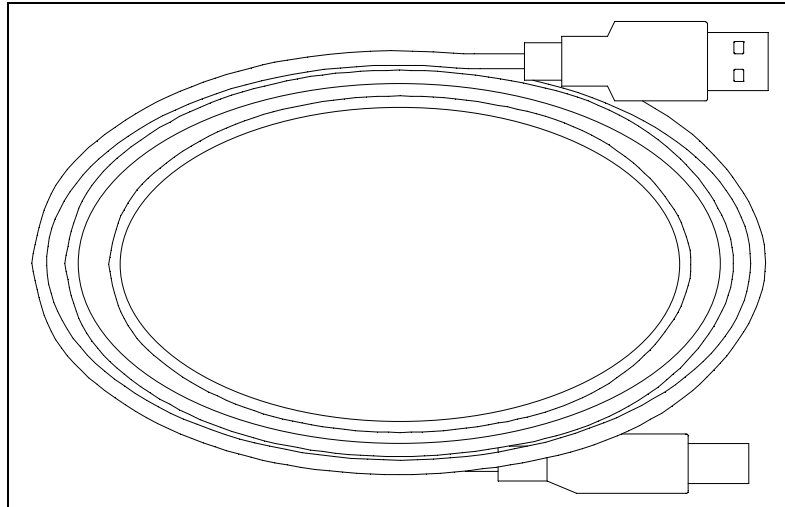

Figure 3: USB Cable

Air Filter and Sample Tubing

A cylindrical particle filter with a short length of tubing is supplied with the SDM-2009 for installation to the AIR fitting on the back panel. The filter keeps particulate contamination out of the docking station.

Three types of sample tubes are included with the docking station. One 3 foot length of 3/16 inch ID polyurethane tubing is provided to connect the regulator on a calibration cylinder to the GAS fitting on the back panel. One 10 foot length of 3/16 inch ID polyurethane tubing is provided for manifolding the GAS fitting. In addition, a 10 foot length of 5/16 inch ID polyurethane tubing is provided for connection to the exhaust fitting on the back panel to allow routing of the exhaust to a location such as an open window where the exhaust can disperse.

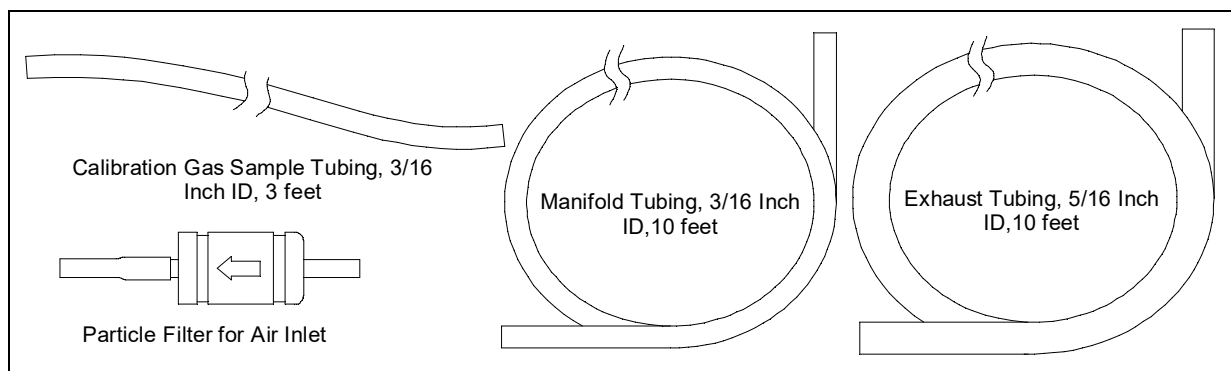

Figure 4: Air Filter & Sample Tubing

WARNING: *Do not use an exhaust tube that is longer than 10 feet. The increased flow restriction caused by a longer tube may affect gas response and cause inaccurate calibration and bump test results.*

Check Valve

A check valve is included with the SDM-2009. Use the check valve on the exhaust fitting when manifolding multiple docking stations together. See “Assembling a Manifold for Multiple SDM-2009s” on page 18 for manifolding instructions.

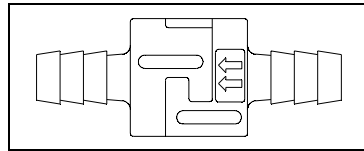

Figure 5: Check Valve

T-Fittings

Two T-fittings are included with the SDM-2009. The larger fitting is for the exhaust tubing manifold construction. The smaller fitting is for the GAS tubing manifold construction.

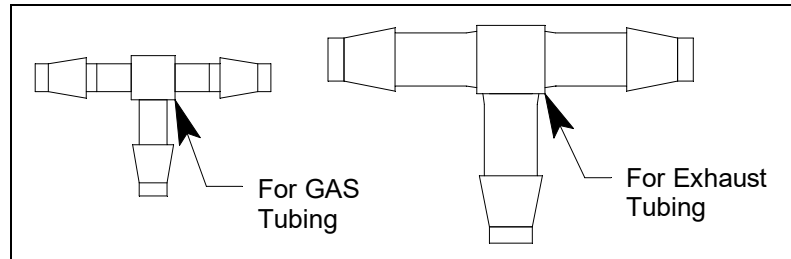

Figure 6: T-Fittings

Instrument Cradle

The instrument cradle is a recessed area on the top of the SM-2009 that is designed to accept the GX-2009. Insert the GX-2009 in the instrument cradle when you perform a bump test or calibration. The cradle has charging contacts on the bottom that mate with the contacts on the back of the GX-2009. There are sample ports in the front of the cradle that match up with the GX-2009's sensors and route air and calibration gas to the sensors during a bump test or calibration. An infrared (IR) port at the back of the cradle lines up with the GX-2009's IR port when it is inserted in the cradle and is used to communicate with the GX-2009. A retaining tab that holds the GX-2009 in the cradle is located to the right of the IR port.

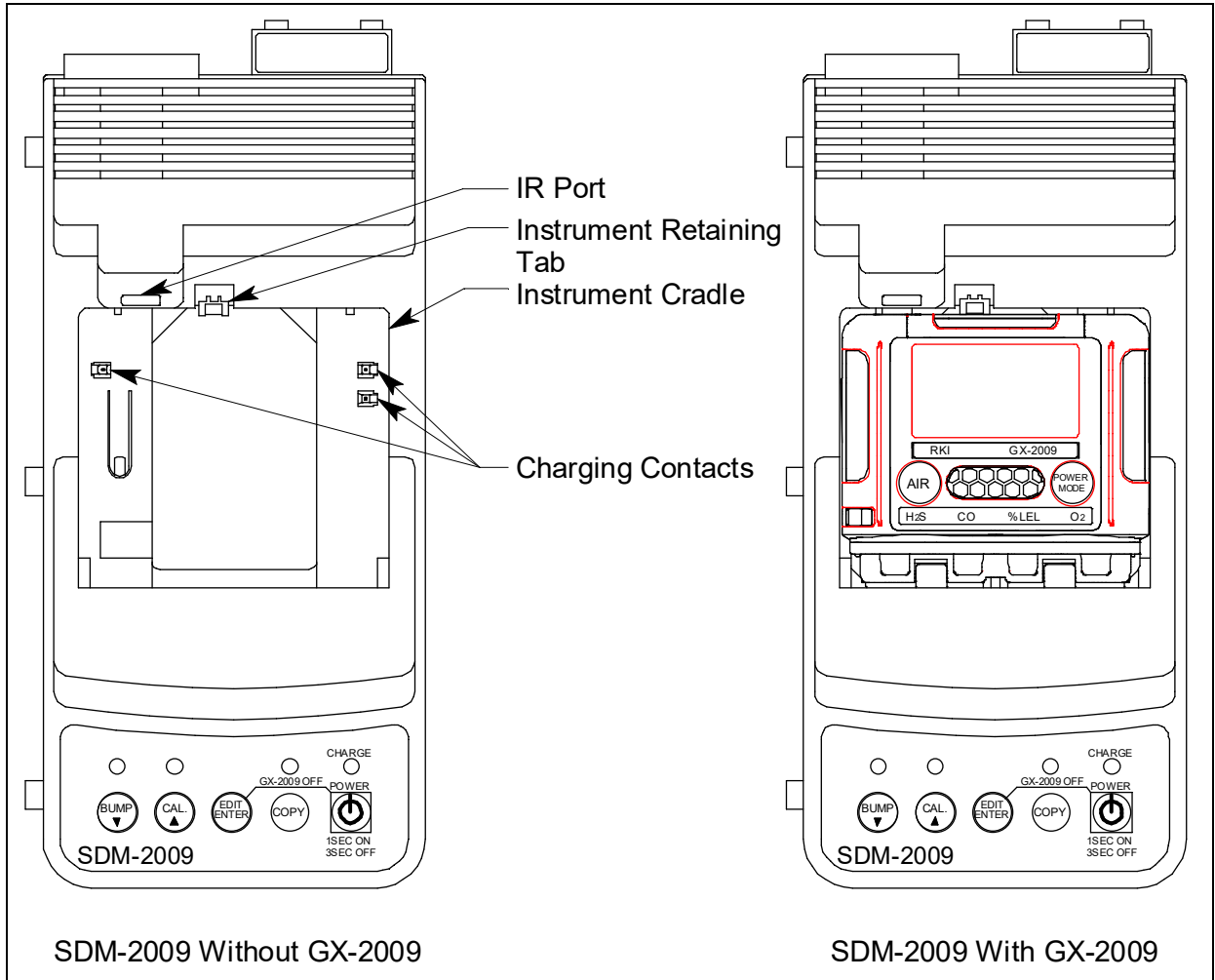

Figure 7: Instrument Cradle

Back Panel

The back panel includes the power jack, sample fittings, and a USB PC connector.

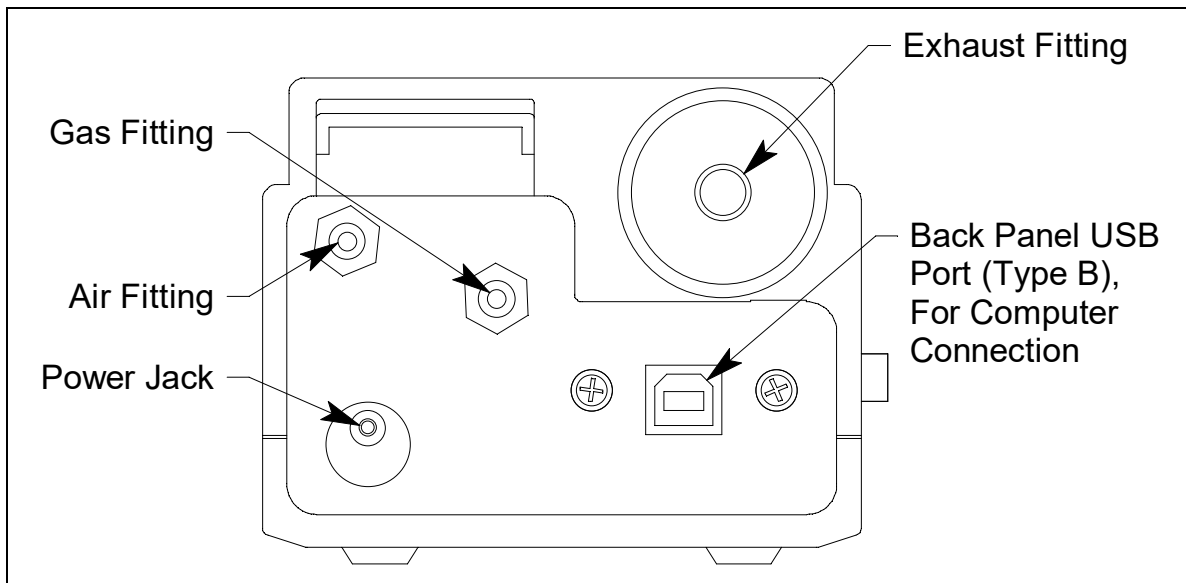

Figure 8: Fittings and Connections

Power Jack

The power jack is located in the bottom left corner of the back panel. The plug on the end of the AC adapter cable mates to it.

Sample Fittings

Three sample fittings are located on the back of the SDM-2009. The AIR fitting is in the upper left corner and draws air into the SDM-2009. The GAS fitting is to the right of the AIR fitting and is used to connect the SDM-2009 to a calibration gas cylinder. Both fittings accept 3/16 inch ID tubing.

An exhaust fitting is located in the upper right corner. It allows routing of the exhausted calibration gas to a convenient location. This fitting accepts 5/16 inch ID tubing. Even though the exhaust gas can be routed to an area to be safely dispersed, the docking station should still be installed in a well ventilated area.

PC Connection

A type B USB connection is located beneath the exhaust fitting on the SDM-2009's back panel. It is only used for the PC Controlled configuration and is not used in the Standalone configuration.

Control Panel

The control panel is used to setup and operate the docking station in the Standalone configuration. It is located at the front of the docking station. It includes the control buttons, the control button LEDs, and the CHARGE status LED.

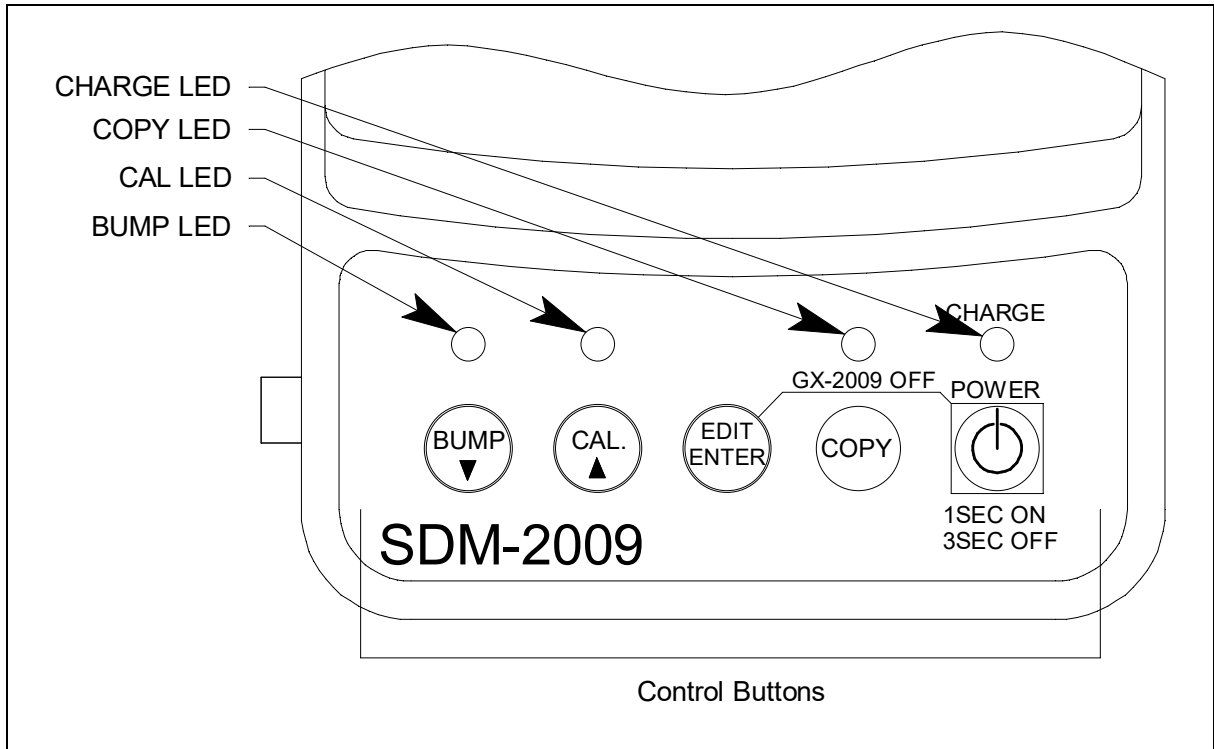

Figure 9: Control Panel

Five control buttons are located on the control panel. From left to right they are BUMP ▼ , CAL ▲ , EDIT ENTER, COPY, and POWER. The BUMP ▼ , CAL ▲ , and COPY control buttons each have an LED above them that indicates the status of the function controlled by that button. The CHARGE LED is located above the POWER button and functions as a pilot LED, a system failure LED, and a charge indication LED.

Table 2: Control Button Functions

Control Button	Control Button Function(s)	Control Button LED Function(s)
BUMP ▼	<ul style="list-style-type: none"> Initiates a bump test Cancels a bump test Moves down a list of parameters Decreases an adjustable parameter 	Indicates status of a bump test in progress

Table 2: Control Button Functions

Control Button	Control Button Function(s)	Control Button LED Function(s)
CAL ▲	<ul style="list-style-type: none"> • Initiates a calibration • Cancels a calibration • Clears data from docking station memory (when used with COPY button) • Moves up a list of parameters • Increases an adjustable parameter 	Indicates status of a calibration in progress
EDIT ENTER	<ul style="list-style-type: none"> • Puts docking station into various edit modes • Makes a displayed parameter editable • Escapes or cancels an operation • Turns off connected instrument (when used with POWER button) 	n/a
COPY	<ul style="list-style-type: none"> • Copies data to a USB flash drive. • Clears data from docking station memory (when used with CAL ▲ button) 	<ul style="list-style-type: none"> • Indicates amount of docking station memory used • Indicates status of copying function • Indicates the result of a copy operation
POWER	<ul style="list-style-type: none"> • Turns on the docking station • Turns off the docking station • Turns off connected instrument (when used with EDIT ENTER button) 	n/a

Front Panel

A type A USB port is located on the front of the docking station. This port can be used to save calibration and bump test data to a USB flash drive. This USB port is for use only in the Standalone configuration of the SDM-2009.

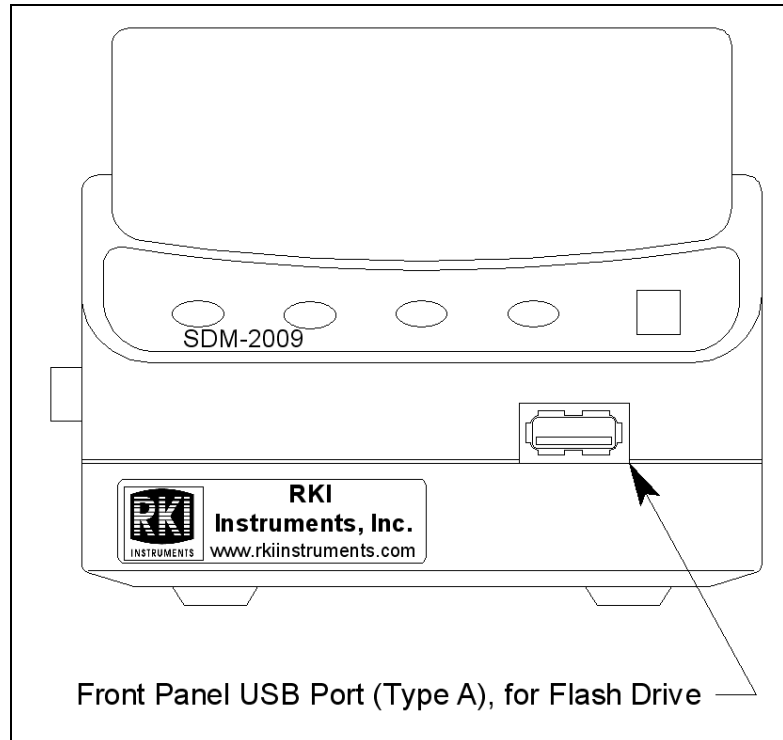

Figure 10: Front Panel

NOTE: The SDM-2009 does not support connection of a computer to the front USB port, only a USB flash drive.

Chapter 3: Preparing to Use the SDM-2009

Overview

There are four tasks that must be completed before you can begin to use the SDM-2009: hardware assembly, setting or confirming the bump test and calibration parameters, connecting calibration gas, and installing the Single Module Data Viewer Software on your computer. This chapter describes how to assemble the parts that are shipped with the SDM-2009, how to set or view the bump test and calibration parameters, and how to install the Single Module Data Viewer Software on a Windows based personal computer.

Hardware Assembly

The hardware assembly consists of connecting the AC adapter, installing the air filter, and connecting the sample tubing. Perform the following to complete the hardware assembly:

1. Place the SDM-2009 on a convenient table top near an AC wall socket in a well ventilated area. A location near a window that can be opened is best so that the exhaust can be routed to the window.
2. Connect the AC adapter's wall plug into a wall AC socket.
3. Insert the round plug on the end of the AC adapter's cable into the power jack on the back of the SDM-2009.

NOTE: If you have multiple SDM-2009s and are using a 4-port AC adapter, plug each of the round plugs on the end of the AC adapter into the power jack on the back of 4 separate SDM-2009s.

4. Install the air filter so that the arrow on the filter that indicates direction of flow is pointing towards the AIR fitting. Push the open end of the flexible tube that is on one end of the filter onto the AIR fitting on the back of the SDM-2009.
5. Install the 10 foot long 5/16 inch ID flexible tube that is included with the SDM-2009 onto the exhaust fitting located in the upper left corner of the back panel. Route the tube to an area where the exhaust can be safely dispersed, such as an open window. Exhaust tubing from multiple units can be daisy chained together in a manifold for more convenient operation. In this case, the check valves that are provided with the docking stations need to be used. See "Assembling a Manifold for Multiple SDM-2009s" below for instructions.

CAUTION: *The maximum recommended length for the exhaust tube is 10 feet. Do not use more than 10 feet of tubing or tubing with an ID of less than 5/16 inch for the exhaust tube or the bump test and calibration accuracy may be adversely affected. The tube that is shipped with the SDM-2009 has an ID of 5/16 inch and is 10 feet long.*

6. Install the 3 foot long 3/16 inch ID tube that is included with the SDM-2009 on the GAS fitting. GAS tubing from multiple units can be daisy chained together in a manifold for more convenient operation. See "Assembling a Manifold for Multiple SDM-2009s" below for instructions.

Assembling a Manifold for Multiple SDM-2009s

Up to 10 SDM-2009s can be manifolded together. The GAS fitting can be manifolded to allow the stations to draw from one calibration cylinder. The exhaust lines can also be manifolded together and be routed away from the docking stations with only one 10 foot long 5/16 inch piece of tubing.

Each SDM-2009 is shipped with exhaust tubing, GAS tubing, T-fittings in two different sizes, and a check valve.

Exhaust Tubing

Reference Figure 11 for the instructions below.

1. Cut a 1-2" piece of 5/16 inch tubing for each SDM-2009 and connect it to each unit's exhaust fitting.
2. Connect the provided check valves to the short pieces of tubing already installed at the exhaust fittings. Be sure that the arrows that appear on the check valve are pointing **away** from the exhaust fitting.
3. Cut a 2-3" piece of 5/16 inch tubing for every SDM-2009 except the first one and connect it to the other end of the check valve.
4. Insert the larger T-fittings into the tubing so that the remaining two ports on the T-fitting are perpendicular to the exhaust tube and check valve.
5. For the first SDM-2009, cut a 9-10" piece of 5/16 inch tubing and connect it from the check valve on the first SDM-2009 to the closest port on the second SDM-2009's exhaust T-fitting.
6. Use one of the provided 10 foot lengths of tubing and connect it to the T-fitting on the last SDM-2009. The maximum recommended exhaust tube length is 10 feet.
7. For the remaining SDM-2009s, cut 6-7" pieces of 5/16 inch tubing and connect the remaining T-fittings.

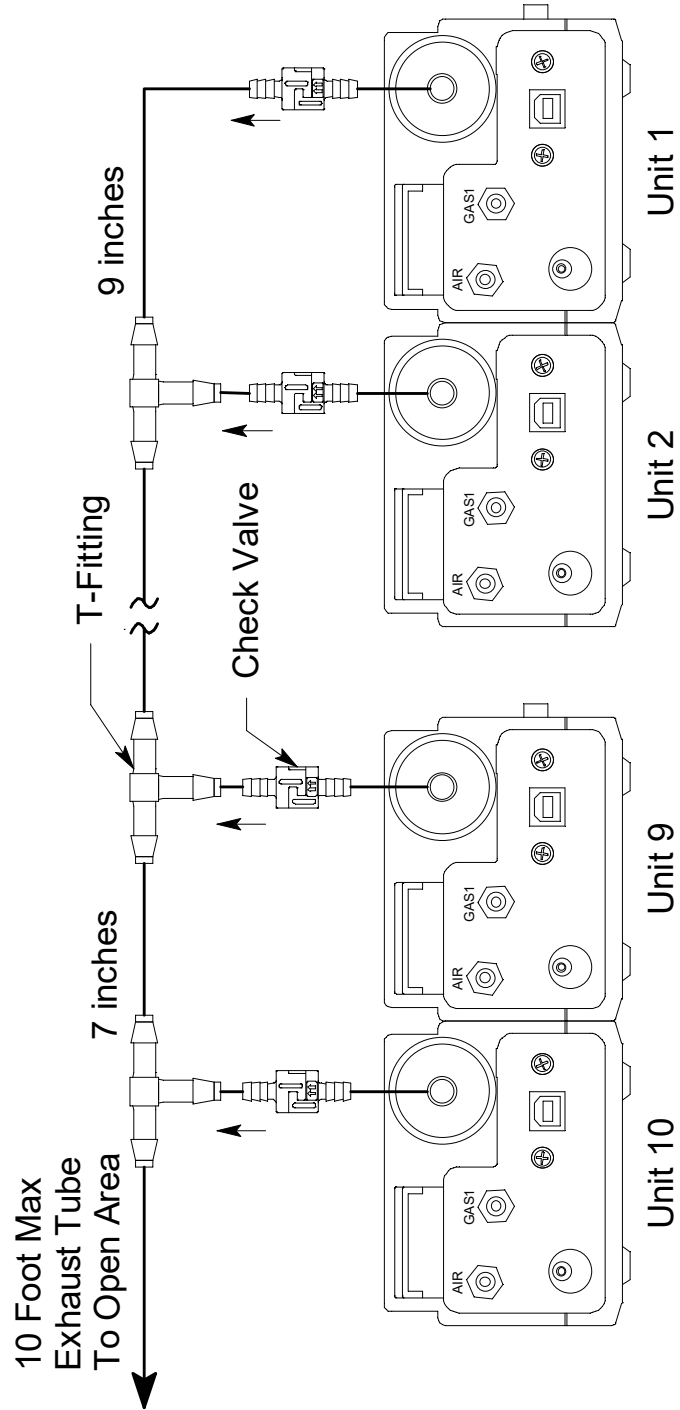

Figure 11: Exhaust Tubing Connections

GAS Tubing

Reference Figure 12 for the instructions below.

1. Cut a 3-4" piece of 3/16 inch tubing for each GAS fitting on every SDM-2009 except the last one.
2. Connect the tubing to the GAS fitting on every SDM-2009 except the last one.
3. Insert the smaller T-fittings into the tubing so that the remaining two ports on the T-fitting are perpendicular to the GAS fitting.
4. Cut 6-7" pieces of 3/16 inch tubing and connect the T-fittings.
5. Cut one more 6-7" piece of 3/16 inch tubing and connect the GAS fitting of the last SDM-2009 to the T-fitting from the second to last SDM-2009.
6. Cut 1 piece of 3/16 inch tubing long enough for easy access to the calibration cylinder and connect it to the T-fitting on the first SDM-2009.

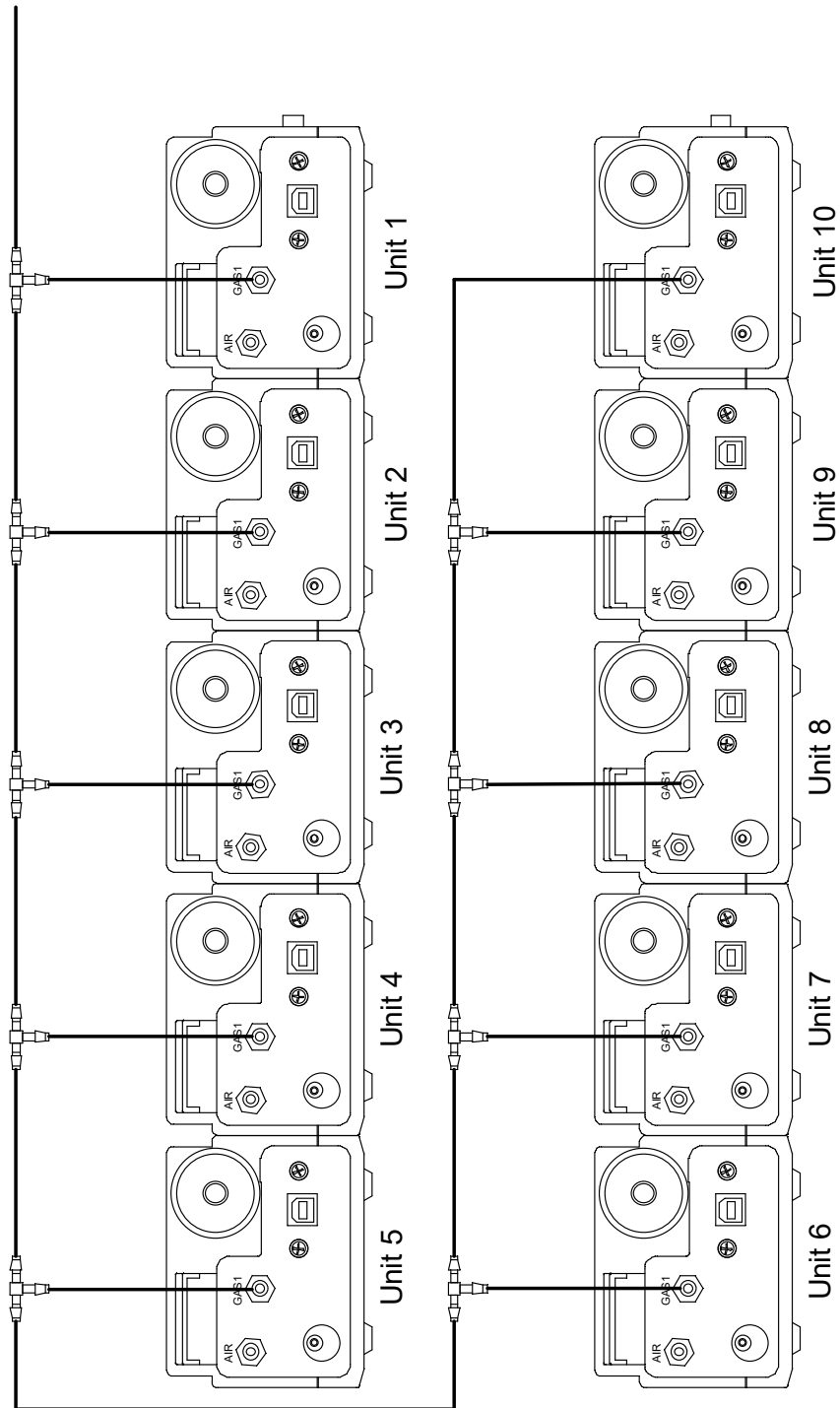

Figure 12: Gas Manifold Connections

Setting the Operational Parameters in Edit Mode

Once the hardware has been assembled, use Edit Mode to confirm or adjust the bump test and calibration parameters before using the SDM-2009.

The bump test parameters define how long fresh air and calibration gas are applied to an instrument during a bump test. They also define the tolerance used in determining whether an instrument fails or passes a bump test and whether or not a calibration automatically takes place if a bump test fails. The calibration parameters define how long fresh air and calibration gas are applied to an instrument during a calibration.

The bump test and calibration parameters are saved in the SDM-2009's memory. If a parameter is changed with one particular instrument installed in the SDM-2009, the change will be in effect for the bump test or calibration of any subsequent instruments until the parameter is changed again.

Bump Test & Calibration Parameters

There are four bump test parameters and two calibration parameters. The two calibration parameters, air sample time and calibration gas sample time, are also bump test parameters. The parameters are described below. Table 3 below shows the factory settings for the bump test and calibration parameters. If you wish to use the factory settings, then you do not need to make any parameter adjustments. If you wish to confirm or change the parameter settings, follow the instructions below in "Setting the Bump Test Parameters" on page 26 or "Setting the Calibration Parameters" on page 28.

Table 3: Bump Test & Calibration Parameter

Parameter	Display Tag	Available Choices	Bump Factory Setting	Cal Factory Setting
Air Sample Time	Air	<ul style="list-style-type: none">• 15 seconds• 30 seconds• 45 seconds• 60 seconds• 90 seconds	15 seconds	45 seconds
Calibration Gas Sample Time	GAS	<ul style="list-style-type: none">• 20 seconds• 30 seconds• 45 seconds• 60 seconds• 90 seconds• 120 seconds	20 seconds	90 seconds

Table 3: Bump Test & Calibration Parameter

Parameter	Display Tag	Available Choices	Bump Factory Setting	Cal Factory Setting
Bump Test Check Tolerance	CHE	<ul style="list-style-type: none"> • ± 10% • ± 20% • ± 30% • ± 40% • ± 50% • ± F10% • ± F20% • ± F30% • ± F40% • ± F50% 	F50%	n/a
Automatic Calibration	CAL	<ul style="list-style-type: none"> • On • Off 	Off	n/a

Air Sample Time (AIR)

The air sample time can be set separately for bump testing and calibration. It is the length of time that the SDM-2009 will draw air through the AIR fitting on the back of the docking station before an air adjust operation.

Calibration Gas Sample Time (GAS)

The calibration gas sample time can be set separately for bump testing and calibration. It is the length of time that the SDM-2009 will draw calibration gas through the GAS fitting on the back of the docking station during a bump test or calibration.

Bump Test Check Tolerance (CHE)

The bump test check tolerance only applies to bump testing. It determines how close the instrument gas reading must be to the calibration gas concentration for each channel during a bump test in order to pass the bump test. It is defined as a percentage of the calibration gas concentration. The amount that the instrument gas reading differs from the calibration gas concentration must be equal to or less than this percentage of the calibration gas concentration. For example, if the tolerance is set to 50%, and the %LEL calibration gas concentration is 50% LEL, then the bump test gas reading for the LEL channel on the instrument must be 50 %LEL ± 25 %LEL.

The F10, F20, F30, etc. options represent a fast bump tolerance. If one of these “F” type tolerances is selected and the gas reading for the sensor(s) being tested is above the lower tolerance and below the upper tolerance within 10 seconds, the sensor(s) pass bump testing, the gas application will be stopped, and the test will move on to the next sensor(s) or to the fresh air purge. If the gas reading on any of the tested channels is below the lower tolerance or above the upper tolerance within 10 seconds, the gas application will continue for the time period defined by the GAS bump test parameter, and the pass/fail status of the sensor(s) will be determined at that point. Using an “F” type tolerance allows calibration gas to be saved when the tested sensors respond quickly and accurately.

Consider the following scenario as an example.

- 50% LEL methane used for bump testing the combustible gas channel
- GAS bump test parameter set to 20 seconds
- Tolerance set to \pm F50%, which means that the acceptable reading range is 25% LEL - 75% LEL

The table below shows possible readings at 10 seconds and the effect on the gas application.

Table 4: Example Fast Bump Scenarios

Gas Reading 10 Seconds Into Fast Bump	Outcome
15% LEL (-70% of 50% LEL)	<ul style="list-style-type: none"> • Gas application continues for the full 20 seconds • Pass/fail determined at end of 20 seconds
30% LEL (-40% of 50% LEL)	<ul style="list-style-type: none"> • Gas application stops • Sensor passes bump testing
60% LEL (+20% of 50% LEL)	<ul style="list-style-type: none"> • Gas application stops • Sensor passes bump testing
80% LEL (+60% of 50% LEL)	<ul style="list-style-type: none"> • Gas application continues for the full 20 seconds • Pass/fail determined at end of 20 seconds

Automatic Calibration (CAL)

Automatic calibration only applies to bump testing. It can be set to on or off. If it is set to on, then the docking station will automatically perform a calibration if a bump test fails.

Turning on the SDM-2009 with an Instrument

Do the following to turn on the SDM-2009 and establish a connection with an instrument:

1. Confirm that the AC adapter is connected to the SDM-2009 and to an AC wall socket.
2. Press and hold the SDM-2009’s POWER button. The LEDs will turn amber.
3. When the BUMP ▼ and CAL ▲ LEDs turn off, release the POWER button.
4. The COPY LED will be steadily on or off and the CHARGE LED will be blinking green if the SDM-2009 is operating properly or solid red if there is a system failure. The amount of free memory in the SDM-2009 will dictate the condition of the COPY LED (see “Available Memory in the SDM-2009” on page 46).
5. Install an instrument into the instrument cradle.

- Press and hold the POWER MODE button on the instrument until you hear a beep, then release it. The instrument will begin its power up sequence (see exceptions below in step 7). If a successful connection between the instrument and the SDM-2009 occurs, the home screen will appear on the instrument display at the end of the startup sequence. The auto calibration values for all installed sensors will be displayed.

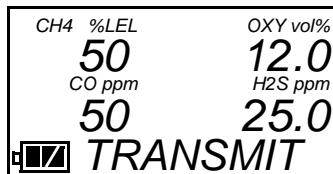

NOTE: The screen shown above applies to a 4-channel GX-2009. If your GX-2009 has less than 4 channels, the inactive channels will not appear in the above screen or in any screens where channels are displayed. All screens in this manual assume a 4-channel GX-2009.

- There are two exceptions to the sequence described in step 6 above. See the GX-2009 User Setup Program Operator's Manual for a description of the **Cal Limit Display** and **Cal Limit Check** instrument parameters.
 - When **Cal Limit Display** is set to *On* and **Cal. Limit Check** is set to *Can't Use*, if the GX-2009 is due for calibration the instrument will show a calibration expired failure screen and the buzzer and LED arrays will pulse for a few seconds.

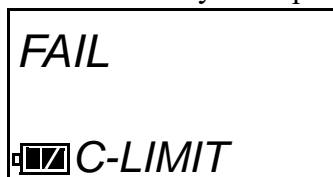

The instrument will then connect to the SDM-2009 and display the home screen shown above in step 6. The CHARGE LED will begin to blink green.

- When **Cal Limit Display** is set to *On* and **Cal. Limit Check** is set to *Confirm to use*, if the GX-2009 is due for calibration the unit will show the following screen and beep and flash the LED arrays for a few seconds indicating that calibration is due.



When the beeping and flashing stops, press and release the POWER MODE button on the GX-2009 to continue. The unit will now connect to the SDM-2009, the home screen shown in step 6 above will be displayed, and the CHARGE LED will begin to blink green.

Setting the Bump Test Parameters

Do the following to set the bump test parameters.

1. Turn on the SDM-2009 with an instrument and establish a connection between them as described above in "Turning on the SDM-2009 with an Instrument". The instrument will display the home screen.

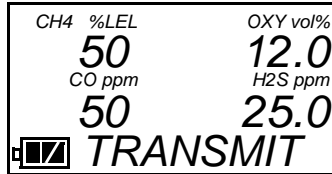

2. Press and hold the EDIT ENTER button for 2 seconds. The instrument will display the Edit Mode screen.



3. Press and release the BUMP ▼ button. The instrument will alternate between the following screens that display the four bump test parameters and their settings. The BUMP ▼ LED will turn green.

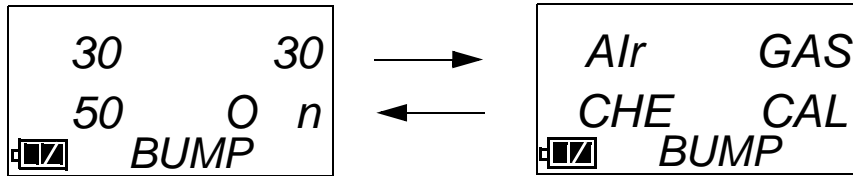

4. If you wish to cancel setting the bump test parameters or were just viewing the parameters to confirm their values, press and release the BUMP ▼ button to return to the home screen.

To continue and change parameters, press and release the EDIT ENTER button. The Air Sample Time parameter will be displayed. For a description of the Air Sample Time bump test parameter, see "Bump Test & Calibration Parameters" on page 22.

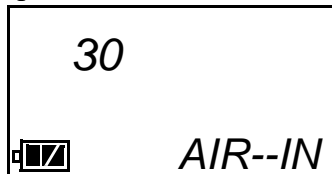

- Use the BUMP ▼ and CAL ▲ buttons to scroll through the different bump test parameters. Do not scroll past the AUTO--C parameter until you have finished making any desired changes.

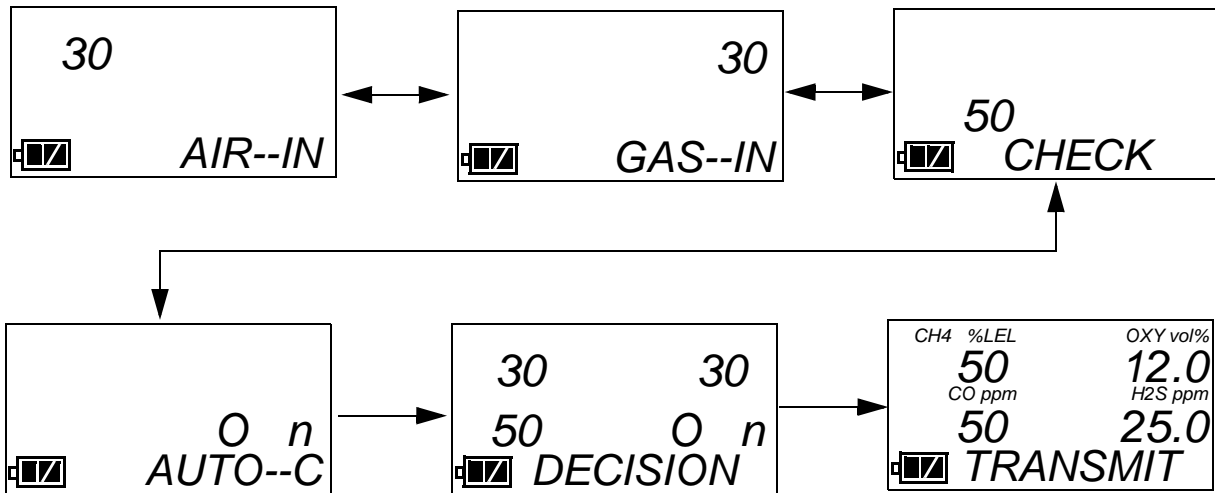

- To edit a parameter, press and release the EDIT ENTER button when that parameter is displayed. An “E” will appear to the left of the parameter name indicating that the parameter value can be changed. In the example below, the AIR--IN parameter has been selected for updating.

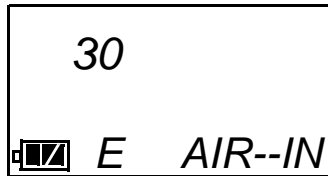

- Use the BUMP ▼ and CAL ▲ buttons to set the parameter to the desired value, then press and release the EDIT ENTER button. The “E” to the right of parameter name will disappear.
- Repeat step 6 - step 7 to set any other parameters.
- When you are done setting the parameters, use the BUMP ▼ button to scroll past the AUTO--C parameter screen. The screen will indicate that the parameter changes have been saved.

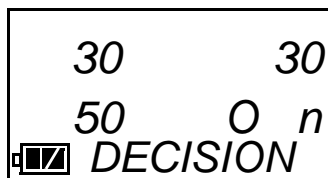

The instrument will return to the home screen.

Setting the Calibration Parameters

Do the following to set the calibration parameters.

1. Turn on the SDM-2009 with an instrument and establish a connection between them as described above in "Turning on the SDM-2009 with an Instrument". The instrument will display the home screen.

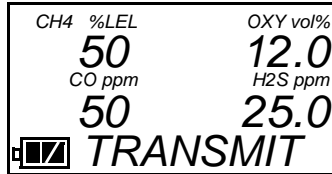

2. Press and hold the EDIT ENTER button for 2 seconds. The instrument will display the Edit Mode screen.



3. Press and release the CAL ▲ button. The instrument will alternate between the following screens that display the two calibration parameters and their settings.

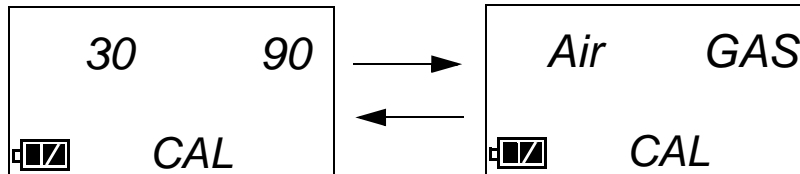

4. If you wish to cancel setting the calibration parameters or were just viewing the parameters to confirm their values, press and release the CAL ▲ button to return to the home screen.

To continue and change parameters, press and release the EDIT ENTER button. The Air Sample Time parameter will be displayed. For a description of the Air Sample Time bump test parameter, see "Bump Test & Calibration Parameters" on page 22.



- Use the BUMP ▼ and CAL ▲ buttons to scroll through the different calibration parameters. Do not scroll past the GAS--IN parameter until you have finished making any desired changes.

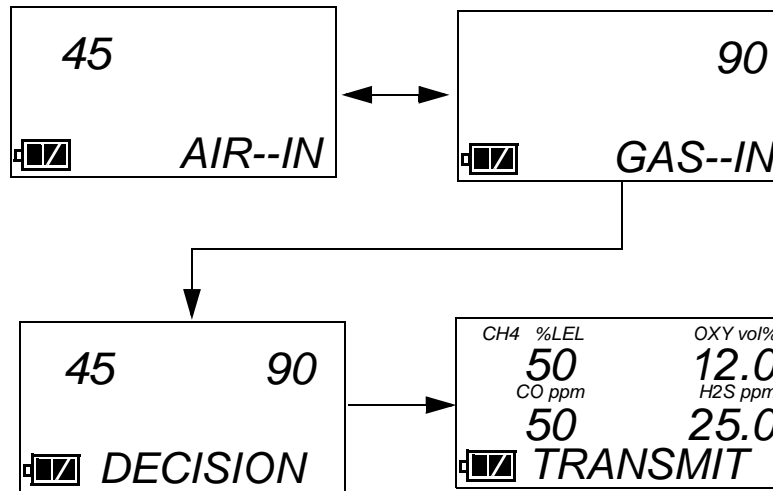

- To edit a parameter, press and release the EDIT ENTER button when that parameter is displayed. An “E” will appear to the right of the parameter name indicating that the parameter value can be changed. In the example below, the AIR--IN parameter has been selected for updating.

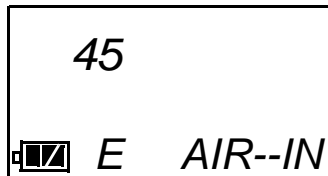

- Use the BUMP ▼ and CAL ▲ buttons to set the parameter to the desired value, then press and release the EDIT ENTER button. The “E” to the right of parameter name will disappear.
- Repeat step 6 - step 7 to set any other parameters.
- When you are done setting the parameters, use the BUMP ▼ button to scroll past the GAS--IN parameter screen. The screen will indicate that the parameter changes have been saved.

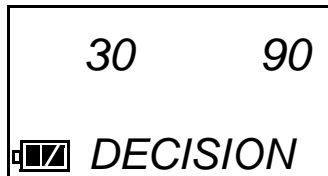

The instrument will return to the home screen.

Connecting Calibration Gas

The GAS fitting on the back of the docking station is designed to be used with a calibration gas cylinder that is fitted with a demand flow regulator. The AIR fitting may be used with a demand flow regulator and a cylinder of zero emissions air, but this is not normally necessary since the docking station will generally be in a fresh air area.

The type of calibration gas cylinder used depends on the gas sensors installed in the instrument being used with the calibration station. A 4-gas mix, LEL/Oxygen/CO/H₂S, is used if the instrument being used with the calibration station is a 4-gas unit. If the instrument does not have an H₂S channel, then a 3-gas mix, LEL/Oxygen/CO, is used. Although a 4-gas cylinder will work for an instrument of any gas combination, if you have multiple instruments with various gas combinations, you may want to keep a 4-gas cylinder and a 3-gas cylinder to help preserve the charcoal filter on the CO sensor in instruments without an H₂S channel. Use Table 5 below as a guide in determining which calibration gas cylinder is appropriate for your system. See “Chapter 6: Spare Parts List” on page 60 for a list of available cylinder part numbers.

Table 5: Recommended Gas Cylinders

Typical Instrument Types	Recommended Calibration Gas Cylinder(s)
LEL/Oxy/H ₂ S/CO	4-gas mix with CH ₄ /Oxy/H ₂ S/CO
LEL/Oxy/CO	3-gas mix with CH ₄ /Oxy/CO
LEL/Oxy/H ₂ S	4-gas mix with CH ₄ /Oxy/H ₂ S/CO
LEL/Oxy	3-gas mix with LEL/Oxy/CO
Oxy/CO	3-gas mix with LEL/Oxy/CO
Oxy/H ₂ S	4-gas mix with LEL/Oxy/H ₂ S/CO

To connect calibration gas to the SDM-2009, do the following:

1. If the area around the docking station is not considered a fresh air area (an area free of combustible and toxic gases and of normal oxygen content, 20.9%) install a tube not longer than 10 feet on the filter attached to the AIR fitting on the back of the docking station and route it to a fresh air area or connect a cylinder of zero air with a demand flow regulator to the AIR fitting.
2. Install the demand flow regulator on the calibration gas cylinder(s).
3. Connect the demand flow regulator to the GAS fitting using the 3 foot length of 3/16 inch ID sample tubing provided with the docking station.

Installing the Single Module Data Viewer Software

1. Launch Windows[®].
2. Exit from all applications and open windows.
3. Click on the **Download** tab.
4. Click the **Standalone Configuration Software** link.
5. A .zip file will begin to download. Select whether you want to open or save the .zip file.
6. Extract the contents of the .zip file.
7. Double click the setup.exe file.
8. The Single Module Data Viewer InstallShield Wizard comes up to guide you through installation. Click **Next** to proceed to the License Agreement window.
9. Read the license agreement and click the agreement acceptance selection box, then click **Next** to proceed to the Customer Information window.
10. Enter a user name and organization and select if you want to install the program for all users on the computer or just for your user account, then click **Next** to proceed to the Destination Folder window.
11. The default installation folder (C:\Program Files\Single Module Data Viewer\) is displayed. If you want to install the software in the default folder continue with step 8. If you want to install the software in a different location, click **Change** and choose a new installation folder now and then continue with step 8.
12. Click **Next** to proceed to the Ready to Install the Program window.
13. Review the installation settings. If they are OK, click **Install** and the installation process will begin. If you want to change installation settings, click **Back** and change them to the desired settings.
14. During software installation, the installation program may find newer versions of Windows files on your computer than those in the downloaded .zip file. If this happens, the installation software will ask you if you want to keep these newer files. Click **Yes** to do so.
15. Follow the on-screen instructions to complete software installation.

Chapter 4: Operation

Overview

When you have completed the tasks in "Chapter 3: Preparing to Use the SDM-2009", you are ready to use the SDM-2009 docking station. The SDM-2009 is capable of performing bump tests and calibrations on the GX-2009. It can also charge the rechargeable batteries in the instrument. This chapter describes procedures for using the docking station to bump test, calibrate, and recharge instruments in the standalone configuration of the docking station. It also describes the information that is saved in the docking station's memory and how to save that information to a USB flash drive for use with the Single Module Data Viewer Program.

Bump Testing a GX-2009

The following instructions apply to GX-2009s with one or more of the standard four sensors (catalytic LEL, O₂, CO, and H₂S).

When a bump test is performed, the SDM-2009 performs a fresh air adjustment on a GX-2009 and then applies calibration gas to the instrument. The docking station then analyzes the response results based on criteria defined by the bump test check tolerance parameter and determines if the instrument passed the bump test. The bump test check tolerance is defined in "Bump Test Check Tolerance (CHE)" on page 23. If the automatic calibration parameter is set to ON, then the SDM-2009 will automatically perform a calibration if the bump test fails.

Do the following to perform a bump test on a GX-2009:

1. Confirm that the AC Adapter is connected to the SDM-2009 and to an AC wall socket.
2. Press and hold the SDM-2009's POWER button. The LEDs will turn amber.
3. When the BUMP ▼ and CAL ▲ LEDs turn off, release the POWER button.
4. The COPY LED will be off or on steadily and the CHARGE LED will be blinking green if the SDM-2009 is operating properly or solid red if there is a system failure. The amount of free memory in the SDM-2009 will dictate the condition of the COPY LED (see "Available Memory in the SDM-2009" on page 46).
5. Install a GX-2009 in the instrument cradle.

NOTE: If the GX-2009 is left in the SDM-2009 after bump testing or calibration, the pump will run for 12 seconds every 2 minutes in order to keep hydrogen generated from charging of the NiMH batteries from affecting the CO sensor.

- Press and hold the POWER MODE button on the GX-2009 until you hear a beep, then release it. The GX-2009 will begin its power up sequence (see exceptions below in step 7). If a successful connection between the instrument and the SDM-2009 occurs, the home screen will appear on the instrument display at the end of the startup sequence. The auto calibration values for all installed sensors will be displayed. If the charge LED was amber, it will begin to blink green.

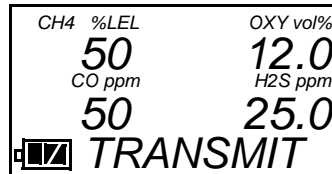

NOTE: The screen shown above applies to a 4-channel GX-2009. If your GX-2009 has less than 4 channels, the inactive channels will not appear in the above screen or in any screens where channels are displayed. All screens in this manual assume a 4-channel GX-2009.

- There are two exceptions to the sequence described in step 6 above. See the GX-2009 User Setup Program Operator’s Manual for a description of the **Cal Limit Display** and **Cal Limit Check** instrument parameters.
 - When **Cal Limit Display** is set to *On* and **Cal. Limit Check** is set to *Can’t Use*, if the GX-2009 is due for calibration the instrument will show a calibration expired failure screen and the buzzer and LED arrays will pulse for a few seconds.

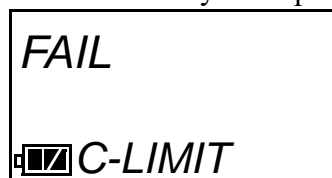

The instrument will then connect to the SDM-2009 and display the home screen shown above in step 6. The CHARGE LED will begin to blink green.

- When **Cal Limit Display** is set to *On* and **Cal. Limit Check** is set to *Confirm to use*, if the GX-2009 is due for calibration the unit will show the following screen and beep and flash the LED arrays for a few seconds indicating that calibration is due.



When the beeping and flashing stops, press and release the POWER MODE button on the GX-2009 to continue. The unit will now connect to the SDM-2009, the home screen shown in step 6 above will be displayed, and the CHARGE LED will begin to blink green.

- If necessary, confirm that the bump test check tolerance is set to the desired value. See “Setting the Bump Test Parameters” on page 26.

9. Verify that the appropriate calibration gas cylinder is connected to the GAS fitting on the back of the SDM-2009. See “Connecting Calibration Gas” on page 30 for calibration gas cylinder options and calibration gas connection procedures.
10. Press and hold the BUMP ▼ button until the BUMP ▼ LED turns on (about one second) then release it. During the bump test, the BUMP ▼ LED will flash amber indicating that a bump test is in progress.



If you wish to cancel the bump test, press and hold the BUMP ▼ button for at least one second until CANCEL appears on the screen.

11. If at any point during the bump test the gas flow to the instrument becomes too low, the bump test will be aborted and the screen will indicate a flow failure.

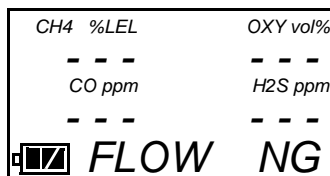

If a flow failure occurs, confirm all tubing connections are correct and that all lines are clear.

- To return to the home screen, press and hold the EDIT ENTER button for about 3 seconds.
 - To start another bump test, press and release the BUMP ▼ button.
 - To perform a calibration, press and release the CAL ▲ button.
12. The SDM-2009 will begin the bump test by applying fresh air to the instrument for the time defined by the Air bump test parameter.
 13. The SDM-2009 will perform a fresh air adjustment on the instrument.
 - If the air adjustment is successful, the SDM-2009 will continue as described in step 14 below.
 - If one or more of the sensors fails the fresh air adjustment, the SDM-2009 will abort the bump test and will not apply calibration gas. If this happens, the BUMP ▼ LED will flash red indicating a failure and the following screens will alternate indicating the fresh air readings and which channels passed and failed the fresh air adjustment with a P (pass) or an F (fail). In the following examples, the CO channel failed.

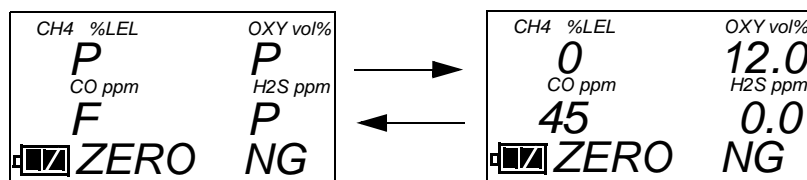



Figure 13: Failed Fresh Air Adjustment

In this case, continue with step 18.

14. The SDM-2009 will apply calibration gas to the instrument for the time defined by the GAS bump test parameter.

CH4 %LEL	OXY vol%
47	11.0
CO ppm	H2S ppm
49	23.0
 BUMP	G 1

15. The SDM-2009 will analyze the results.

- If the bump test passes, continue with step 16.
- If the bump test fails, and CAL is set to OFF, continue with step 16.
- If the bump test fails, and CAL is set to ON, a calibration will automatically begin and calibration gas will continue to flow. The CAL ▲ LED will begin to flash amber.

NOTE:

Calibration gas will continue to be applied so that the total gas application time is the time defined by the GAS calibration parameter. This time includes the time that the instrument was being bump tested. If the GAS **calibration parameter** is set to 90 seconds and the GAS **bump test parameter** is set to 30 seconds, the instrument will sample gas for an additional 60 seconds if the bump test fails to bring the total exposure time to 90 seconds.

CH4 %LEL	OXY vol%
47	11.0
CO ppm	H2S ppm
49	23.0
 B/CAL	G 1

At the end of the calibration gas application, the SDM-2009 will analyze the results. See “Using the Single Module Data Viewer Program” on page 50 for a description of calibration results.

16. The SDM-2009 will then purge the system with fresh air for 5 seconds.

 BUMP AIR
--

17. After the fresh air purge is complete, the GX-2009 screen will alternate between the gas readings and the bump test or bump test and calibration results. For a successful bump test, the gas readings at the end of the gas application will be displayed. For a successful automatic calibration, the auto calibration values will be displayed. For a failed bump test or automatic calibration, the gas readings at the end of the gas application will be displayed. If all channels passed the bump test, the BUMP ▼ LED will turn solid green. If any channels failed the bump test, the BUMP ▼ LED will turn solid red. If all channels passed the calibration, the CAL ▲ LED will turn solid green. If any channels failed the calibration, the CAL ▲ LED will turn solid red.

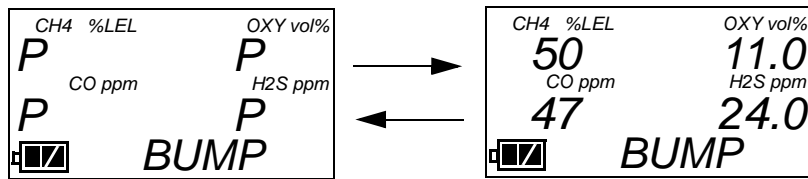

Figure 14: Screen Indication for Passed Bump Test

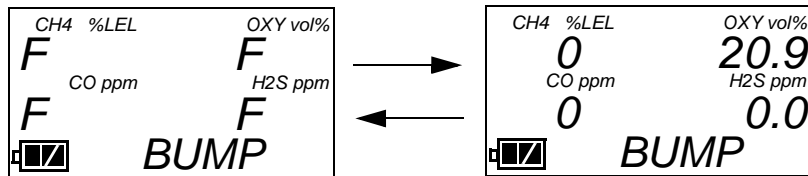

Figure 15: Screen Indication for Failed Bump Test, CAL OFF

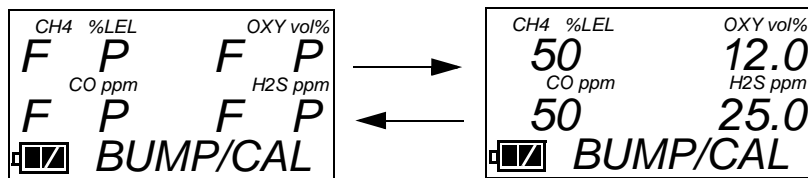

Figure 16: Screen Indication for Failed Bump Test and Passed Automatic Calibration

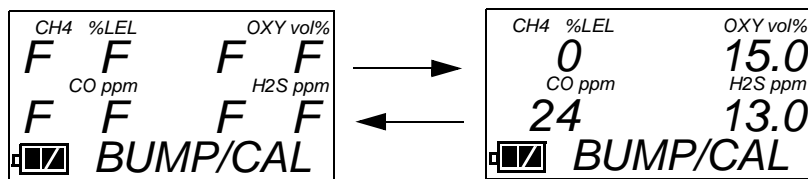

Figure 17: Screen Indication for Failed Bump Test and Failed Calibration

18. After a successful or failed bump test,

- To perform any other operations:

To perform another bump test, press and hold the BUMP ▼ button until the pump starts. To perform a calibration, press and hold the CAL ▲ button until the pump starts. To return to the home screen, press and hold the EDIT ENTER button until the home screen appears.

- To turn the GX-2009 off:

If the bump test was successful, the instrument will shut off after 15 seconds. If the bump test failed, the instrument will shut off after 10 minutes. If buttons are pressed before the SDM-2009 turns off the instrument, it will automatically turn it off 10 minutes after the last button push.

To turn off the instrument before it is automatically turned off, press and hold the EDIT ENTER and POWER buttons simultaneously for about one second and then release them when the instrument turns off. To avoid accidentally entering Edit Mode, press and hold the POWER button first, then press and hold the EDIT ENTER button.

CAUTION: *When using the GX-2009 with the SDM-2009, do not turn off the instrument using the instrument power button. Use the EDIT ENTER and POWER buttons on the SDM-2009 to turn off the instrument.*

The BUMP ▼ or BUMP ▼ and CAL ▲ LEDs will remain on indicating the test results. If the same GX-2009 is turned on again, the test results will still be indicated by the BUMP ▼ or BUMP ▼ and CAL ▲ LEDs and on the GX-2009 screen. To clear the BUMP ▼ or BUMP ▼ and CAL ▲ LEDs, with the GX-2009 on, press and hold the EDIT ENTER button for about 3 seconds until the display returns to the home screen. If a new GX-2009 is turned on and connected, the results displayed by the BUMP ▼ or BUMP ▼ and CAL ▲ LEDs will automatically be cleared.

19. The results of the bump test or bump test and calibration will be stored in the SDM-2009's memory and will be available to copy to a USB flash drive. See "Copying Calibration and Bump Test Records to a USB Flash Drive" on page 46 for instructions to copy the saved bump test and calibration records to a USB flash drive.
20. Remove the GX-2009 from the SDM-2009.
21. If you wish to bump test additional instruments, repeat step 5 - step 20 above for each additional instrument.

Calibrating a GX-2009

The following instructions apply to GX-2009s with one or more of the standard four sensors (catalytic LEL, O₂, CO, and H₂S).

When a calibration is performed, the docking station performs a fresh air adjustment on an instrument and then applies calibration gas to the instrument. The docking station analyzes the calibration results and determines if the instrument passed the calibration.

To perform a calibration on a GX-2009:

1. Confirm that the AC adapter is connected to the SDM-2009 and to an AC wall socket.
2. Press and hold the SDM-2009's POWER button. The LEDs will turn amber.
3. When the BUMP ▼ and CAL ▲ LEDs turn off, release the POWER button.

4. The COPY LED will be off or on steadily and the CHARGE LED will be blinking green if the SDM-2009 is operating properly or solid red if there is a system failure. The amount of free memory in the SDM-2009 will dictate the condition of the COPY LED (see “Available Memory in the SDM-2009” on page 46).
5. Install a GX-2009 in the instrument cradle.

NOTE: If the GX-2009 is left in the SDM-2009 after bump testing or calibration, the pump will run for 12 seconds every 2 minutes in order to keep hydrogen generated from charging of the NiMH batteries from affecting the CO sensor.

6. Press and hold the POWER MODE button on the GX-2009 until you hear a beep, then release it. The GX-2009 will begin its power up sequence (see exceptions below in step 7). If a successful connection between the instrument and the SDM-2009 occurs, the home screen will appear on the instrument display at the end of the startup sequence. The auto calibration values for all installed sensors will be displayed. If the charge LED was amber, it will begin to blink green.

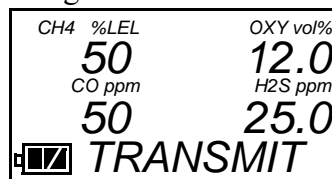

NOTE: The screen shown above applies to a 4-channel GX-2009. If your GX-2009 has less than 4 channels, the inactive channels will not appear in the above screen or in any screens where channels are displayed. All screens in this manual assume a 4-channel GX-2009.

7. There are two exceptions to the sequence described in step 6 above. See the GX-2009 User Setup Program Operator’s Manual for a description of the **Cal Limit Display** and **Cal Limit Check** instrument parameters.
 - When **Cal Limit Display** is set to *On* and **Cal. Limit Check** is set to *Can’t Use*, if the GX-2009 is due for calibration the instrument will show a calibration expired failure screen and the buzzer and LED arrays will pulse for a few seconds.

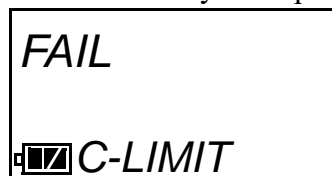

The instrument will then connect to the SDM-2009 and display the home screen shown above in step 6. The CHARGE LED will begin to blink green.

- When **Cal Limit Display** is set to *On* and **Cal. Limit Check** is set to *Confirm to use*, if the GX-2009 is due for calibration the unit will show the following screen and beep and flash the LED arrays for a few seconds indicating that calibration is due.



When the beeping and flashing stops, press and release the POWER MODE button on the GX-2009 to continue. The unit will now connect to the SDM-2009, the home screen shown in step 6 above will be displayed, and the CHARGE LED will begin to blink green.

- Verify that the appropriate calibration gas cylinder is connected to the GAS fitting on the back of the SDM-2009. See “Connecting Calibration Gas” on page 30 for calibration gas cylinder options and calibration gas connection procedures.
- Press and hold the CAL ▲ button until the CAL ▲ LED turns on (about one second) then release it. During the calibration, the CAL ▲ LED will flash amber indicating that a calibration is in progress.

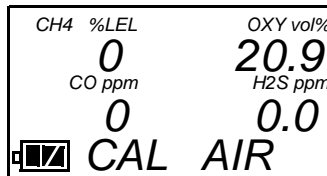

If you wish to cancel the calibration, press and hold the CAL ▲ button for at least one second until CANCEL appears on the screen.

- If at any point during the calibration the gas flow to the instrument becomes too low, the calibration will be aborted and the screen will indicate a flow failure.

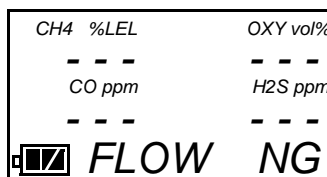

If a flow failure occurs, confirm all tubing connections are correct and that all lines are clear.

- To return to the home screen, press and hold the EDIT ENTER button for about 3 seconds.
 - To start another calibration, press and release the CAL ▲ button.
 - To perform a bump test, press and release the BUMP ▼ button.
- The SDM-2009 begins the calibration by applying fresh air to the instrument for the time defined by the Air calibration parameter.
 - The SDM-2009 will perform a fresh air adjustment on the instrument.
 - If the air adjustment is successful, the SDM-2009 will continue as described in step 13 below.

- If one or more of the sensors fails the fresh air adjustment, the SDM-2009 will abort the calibration and will not apply calibration gas. If this happens, the CAL ▲ LED will flash red indicating a failure and the following screens will alternate indicating the fresh air readings and which channels passed and failed the fresh air adjustment with a P (pass) or an F (fail). In the following examples, the CO channel failed the fresh air adjustment.

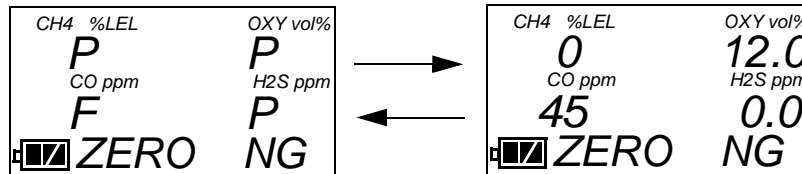
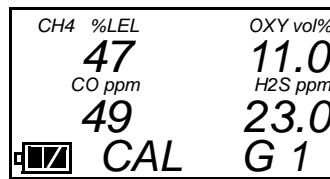

Figure 18: Failed Fresh Air Adjustment

In this case continue with step 16.

13. The SDM-2009 will apply calibration gas to the instrument for the time defined by the GAS calibration parameter.



14. The SDM-2009 will then purge the system with fresh air for 5 seconds.

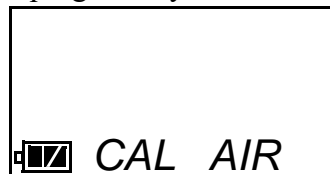

15. After the fresh air purge is complete, the screen will alternate between the gas readings and the calibration results. If the calibration passed, the auto calibration values will be displayed. If the calibration failed, the gas readings at the end of the gas application will be displayed. The calibration results are indicated with a P (pass) or an F (fail) below the channel units. The CAL ▲ LED will stop blinking and be steadily green if all channels passed the calibration or steadily red if any channel failed the calibration. In the examples below, the CO sensor failed calibration.

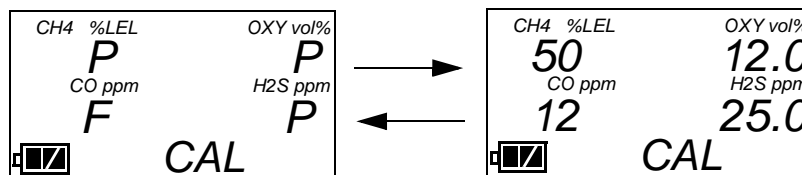

Figure 19: Calibration Results

16. After a successful or failed calibration,

- To perform any other operations:

To perform a bump test, press and hold the BUMP ▼ button until the pump starts. To perform another calibration, press and hold the CAL ▲ button until the pump starts. To return to the home screen, press and hold the EDIT ENTER button until the home screen appears.

- To turn the GX-2009 off:

If the calibration was successful, the instrument will shut off after 15 seconds. If the calibration failed, the instrument will shut off after 10 minutes. If buttons are pressed before the SDM-2009 turns off the instrument, it will automatically turn it off 10 minutes after the last button push.

To turn off the instrument before it is automatically turned off, press and hold the EDIT ENTER and POWER buttons simultaneously for about one second and then release them. To avoid accidentally entering Edit Mode, press and hold the POWER button first, then press and hold the EDIT ENTER button.

CAUTION: *When using the GX-2009 with the SDM-2009, do not turn off the instrument using the instrument power button. Use the EDIT ENTER and POWER buttons on the SDM-2009 to turn off the instrument.*

The CAL ▲ LED will remain on indicating the test results. If the same GX-2009 is turned on again, the test results will still be indicated by the CAL ▲ LED and on the GX-2009 screen. To clear the CAL ▲ LED, with the GX-2009 on, press and hold the EDIT ENTER button for about 3 seconds until the display returns to the home screen. If a new GX-2009 is turned on and connected, the results displayed by the CAL ▲ LED will automatically be cleared.

17. The results of the calibration will be stored in the SDM-2009's memory and will be available to copy to a USB flash drive. See "Copying Calibration and Bump Test Records to a USB Flash Drive" on page 46 for instructions to copy the saved bump test and calibration records to a USB flash drive.
18. Remove the GX-2009 from the SDM-2009.
19. If you wish to calibrate additional instruments, repeat step 5 - step 18 above for each additional instrument.

Troubleshooting

NOTE: This troubleshooting guide describes SDM-2009 problems only. See the GX-2009 Operator's Manual for problems you may encounter with the instrument.

Table 6: Troubleshooting the SDM-2009

Symptoms	Probable Causes	Recommended Action
<ul style="list-style-type: none"> Fresh air adjustment fails 	<ul style="list-style-type: none"> The SDM-2009 is not in a fresh air environment or the cylinder being used is not a zero air cylinder. If a zero air cylinder is used, the calibration cylinder is out of gas. If a zero air cylinder is used, the tubing from the regulator to the AIR fitting is not connected. 	<ol style="list-style-type: none"> Confirm that the SDM-2009 is in a fresh air environment or that a zero air cylinder is attached to the AIR fitting. If a zero air cylinder is used, verify that it contains an adequate supply of test sample. If a zero air cylinder is used, check all calibration tubing for leaks or for any bad connections. If the fail condition continues, replace the sensor(s) in the instrument. If the difficulties continue, contact for further instruction.
<ul style="list-style-type: none"> Calibration fails 	<ul style="list-style-type: none"> The auto calibration values do not match the cylinder gas concentrations. The calibration cylinder is out of gas or is outdated. The calibration cylinder is not connected to the GAS fitting. The instrument is not properly inserted in the instrument cradle. The tubing from the regulator to the GAS fitting is not connected. 	<ol style="list-style-type: none"> Confirm that the auto calibration values match the concentrations listed on the gas cylinder. Verify that the calibration cylinder contains an adequate supply of fresh test sample. Verify that the calibration cylinder is connected to the GAS fitting. Check to make sure the instrument is properly inserted in the instrument cradle. Check all calibration tubing for leaks or for any bad connections. If the fail condition continues, replace the sensor(s) in the instrument. If the difficulties continue, contact for further instruction.

<ul style="list-style-type: none"> No IR connection between instrument and SDM-2009 	<ul style="list-style-type: none"> SDM-2009 is not turned on. The instrument is not correctly inserted into the instrument cradle. The IR window is dirty. 	<ol style="list-style-type: none"> Turn on the SDM-2009. If it does not turn on, check that the AC adapter is plugged into an AC socket and to the jack on the back of the SDM-2009. Check to make sure the instrument is inserted properly. Clean the IR window on the SDM-2009 and the GX-2009. If the difficulties continue, contact for further instruction.
<ul style="list-style-type: none"> Control buttons do not function correctly for standalone operation 	<ul style="list-style-type: none"> The SDM-2009 is connected to a computer and the PC Controller program is running. 	<p>Disconnect the USB cable from the back of the SDM-2009 if it is connected. See the SDM-2009 PC Controlled Configuration Operator's Manual for instructions to use the SDM-2009 in PC Controlled configuration.</p>
<ul style="list-style-type: none"> The COPY function does not copy files to the USB drive 	<ul style="list-style-type: none"> The USB drive is defective. The USB drive is not inserted properly. The SDM-2009 is connected to a computer, the PC Controller program is running, and an instrument is turned on. 	<ol style="list-style-type: none"> Perform a COPY operation with a different USB drive. Be sure that the USB drive is inserted correctly. Disconnect the SDM-2009 from the computer. If the difficulties continue, contact for further instruction.
<ul style="list-style-type: none"> The rechargeable batteries in the instrument are not charging 	<ul style="list-style-type: none"> The instrument is not properly inserted in the instrument cradle. The charger is malfunctioning. The batteries are faulty. 	<ol style="list-style-type: none"> Be sure that the instrument is fully inserted in the instrument cradle. Try to charge the batteries in a BC-2009 charger if one is available to determine if the SDM-2009 is at fault. Try to charge the batteries using a different SDM-2009 if one is available to determine if the SDM-2009 is at fault. Replace the batteries and attempt to charge them. See the GX-2009 Operator's Manual for instructions to change the batteries. If the difficulties continue, contact for further instruction.

Charging an Instrument in a Docking Station

The SDM-2009 can be used to charge the rechargeable batteries in a GX-2009. To maximize the instrument's run time and the battery life, make sure the batteries' charge is as low as possible before recharging them. You can use the GX-2009's REFRESH function to discharge the batteries. See the GX-2009 Operator's Manual for a complete description of the REFRESH button.

Recharging the Batteries After Performing a Bump Test or Calibration

1. Perform a bump test or calibration on an instrument as described in "Bump Testing a GX-2009" on page 32, "Calibrating a GX-2009" on page 37.
2. After the bump test or calibration has been completed, turn off the instrument by pressing and holding the EDIT ENTER and POWER buttons simultaneously until the instrument turns off, about one second, and then releasing them. The docking station will automatically turn off the instrument 15 seconds after a successful bump test or calibration or if no buttons are pressed for 10 minutes.
3. While the instrument is on, the CHARGE LED will be blinking green. When the instrument is turned off, the CHARGE LED will blink amber. The BUMP ▼ and/or CAL ▲ LED will continue to be either green or red depending on the result of the previous bump test or calibration.

NOTE: The SDM-2009 does not start charging the batteries until the instrument is off. While the instrument is on, the CHARGE LED will blink green. Once the instrument is shut off, the CHARGE LED will begin to blink amber.

4. If the batteries are fully charged, then the CHARGE LED will turn solid green in a few minutes.

If the batteries are drained enough for the docking station to charge them, the CHARGE LED will continue to blink amber while charging is taking place. The SDM-2009 will take approximately 3 hours to charge a fully discharged GX-2009.

If the charging process encounters a fail condition, the CHARGE LED will turn steadily red.

NOTE: If the GX-2009 is left in the SDM-2009 after bump testing or calibration, the pump will run for 12 seconds every 2 minutes in order to keep hydrogen generated from charging of the NiMH batteries from affecting the CO sensor.

5. When the charge is complete, the CHARGE status LED will turn solid green.

Recharging the Batteries Without Performing Any Operations

1. Confirm that the AC adapter is connected to the back panel of the SDM-2009 and to an AC wall socket.
2. Insert the instrument into the instrument cradle.

3. Press and hold the SDM-2009's POWER button. The LEDs will turn amber.
4. When the BUMP ▼ and CAL ▲ LEDs turn off, release the POWER button.
5. The CHARGE LED will be blinking amber.
6. If the batteries are fully charged, then the blinking amber LED will turn solid green in a few minutes.

If the batteries are drained enough for the SDM-2009 to charge them, the CHARGE LED will continue to blink amber while charging is taking place. The SDM-2009 will take approximately 3 hours to charge a fully discharged GX-2009.

If the charging process encounters a fail condition, the CHARGE LED will turn steadily red.

7. When the charge is complete, the CHARGE status LED will turn solid green.

Batteries Too Drained for Standalone Operation

If the NiMH batteries do not have enough power to keep the instrument on, it will go into a 5 minute charge cycle and the following screen will be displayed on the instrument screen.

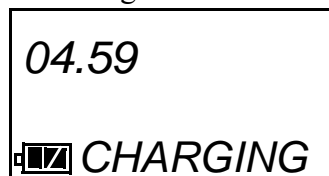

It will not connect to the docking station. The instrument cannot be bump tested or calibrated in the charge cycle. Once the 5 minute charge cycle has ended, the unit will automatically turn back on and connect to the docking station. The unit can now be bump tested or calibrated.

Calibration and Bump Test Records

The SDM-2009 saves a record of each bump test and calibration performed. It is capable of saving up to 200 such records. When an SDM-2009's memory becomes full, the oldest record is overwritten when a new record is saved. The records saved in the SDM-2009's memory can be saved to a USB flash drive using the USB port on the front.

Available Memory in the SDM-2009

The COPY LED indicates how much of the SDM-2009's memory has been used. The table below describes the various indications.

Table 7: COPY LED Indications

COPY LED Indication	Memory Used
Off	None. No records are saved
Solid Green	Less than 80% of the SDM-2009's memory has been used.
Solid Amber	More than 80% of the SDM-2009's memory has been used.
Solid Red	The docking station's memory is full. A newly saved record will overwrite the oldest one.

Copying Calibration and Bump Test Records to a USB Flash Drive

The SDM-2009 will only perform a copy operation if there is at least one record saved in its memory. If there are no records saved in the docking station's memory, the COPY LED will be off and the COPY button will not function. Do the following to copy calibration and bump test records in the SDM-2009's memory to a USB flash drive.

NOTE: The USB port on the front of the docking station cannot be used to connect the SDM-2009 to a computer, only to save calibration and bump test records to a USB flash drive.

1. Confirm that the AC Adapter is connected to the SDM-2009 and to an AC wall socket.
2. Press and hold the SDM-2009's POWER button. The LEDs will turn amber.
3. When the BUMP ▼ and CAL ▲ LEDs turn off, release the POWER button.
4. The COPY LED will be off or on steadily and the CHARGE LED will be blinking green. The amount of free memory in the SDM-2009 will dictate the condition of the COPY LED (see "Available Memory in the SDM-2009" above).
5. Install a USB flash drive into the USB port on the front of the SDM-2009. The SDM-2009 will take a few seconds to determine how much memory is available in the flash drive.
 - If the flash drive's available memory is not enough for the contents of the SDM-2009's memory, the COPY LED will alternate between green and red. Enough memory will

have to be cleared in the flash drive to make room for the records in the SDM-2009's memory.

- If there is enough available memory in the flash drive for the contents of the SDM-2009's memory, the COPY LED will begin flashing in the same color that it was before installing the flash drive.
6. Press and hold the COPY button until the COPY LED turns red, then release it. The COPY LED will become solid red while the records in the docking station's memory are copied to the flash drive. In addition, if the flash drive has an LED, it will begin to blink.
 7. When the COPY LED returns to its original color and begins blinking again and the flash drive's LED (if it has one) stops blinking, the copy operation is complete. Remove the flash drive from the USB port.

NOTE: If you pull out the flash drive while its LED is still blinking or the COPY LED is still solid red, the file saved in the flash drive with the calibration and bump test records may be incomplete.

8. If the flash drive has not already been used with a docking station, a folder named **DAT** will be created on the flash drive and a file with all the saved calibration and bump test records will be saved to this folder.

If the flash drive has been used before with a docking station, the file will be saved to the existing **DAT** folder.
9. The files on the flash drive can now be either transferred to a computer or kept on the flash drive for use with the Single Module Data Viewer Software. See "Bump Test and Calibration Record Files" below for a discussion of these files and how to use them.

Clearing the SDM-2009's Memory

Make sure that you save the bump test and calibration records in the SDM-2009's memory to a flash drive before clearing its memory. The docking station's memory can be cleared by simultaneously pressing and holding the CAL ▲ and COPY buttons for five seconds. After the SDM-2009's memory has been cleared, the COPY LED will turn off indicating there are no records to be copied.

Bump Test and Calibration Record Files

Each time a copy function is performed, a file is saved to the flash drive in the **DAT** folder. The file name will begin with "SDM-2009" and the remainder of the file name will depend on the serial number of the SDM-2009 used and the date of the most recent bump test or calibration performed on the SDM-2009. So it is possible to have multiple files in the DAT folder from the SDM-2009.

The files that an SDM-2009 saves to a USB flash drive are structured so that they can be imported into a database controlled by the Single Module Data Viewer Software. See "Importing Files Into the Database" on page 51 for instructions to add files to the database.

Bump Testing or Calibrating and Saving Files To a Flash Drive Multiple Times In One Day

The SDM-2009 assigns file names to calibration and bump test record files based on the day of the most recent calibration or bump test record saved in the docking station's memory. If bump tests or calibrations are performed, a copy operation is performed, then additional bump tests or calibrations are performed, and another copy operation is performed with the same flash drive all on the same day, the existing file on the flash drive from the first copy operation will be overwritten by the file from the second copy operation because its name will be the same as the new file. In this case, no information is lost since the second file saved to the flash drive includes all the records that were in the first file.

However, if bump tests or calibrations are performed, a copy operation is performed, and **the SDM-2009's memory is cleared**, then additional bump tests or calibrations are performed, and another copy operation is performed with the same flash drive all on the same day, this will result in the information in the file from the first copy operation being lost. This is because the file saved to the flash drive in the second copy operation only includes records since the memory was cleared and when it overwrites the file from the first copy operation, all the information in the first file is lost.

CAUTION: *If performing bump tests or calibrations and copying an SDM-2009's memory to a flash drive multiple times during the same day and the SDM-2009's memory is cleared, transfer the calibration/bump test record files from the flash drive to a computer hard drive or some other memory device before performing another copy operation to avoid loss of data.*

Chapter 5: Single Module Data Viewer Program

Overview

The Single Module Data Viewer Program is used to view, organize, and print bump test and calibration records that were created by the SDM-2009 while used in the standalone configuration. It can also be used to export these records from its database for use in other programs. This chapter describes how to use the Single Module Data Viewer Program.

Launching the Single Module Data Viewer Program

1. Click **Start** on the Windows[®] Icon Tray, then select **Programs/Single Module Data Viewer**.

NOTE: If you are starting the software for the first time, a message window appears informing you that a database has been created. If this occurs, click **OK**.

2. The Single Module Data Viewer program is launched and the data viewing window appears.

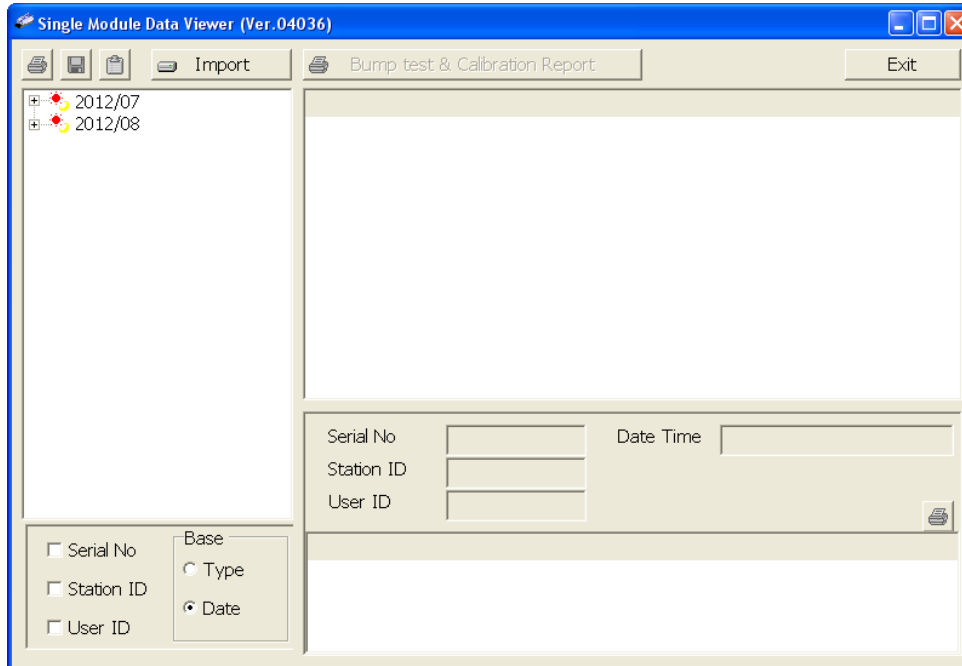

Figure 20: Single Module Data Viewer Window

NOTE: When you start the Single Module Data Viewer Program for the first time, there will be no data in the left part of the data viewing window since no data has been imported into the database yet.

Using the Single Module Data Viewer Program

Data Viewing Window

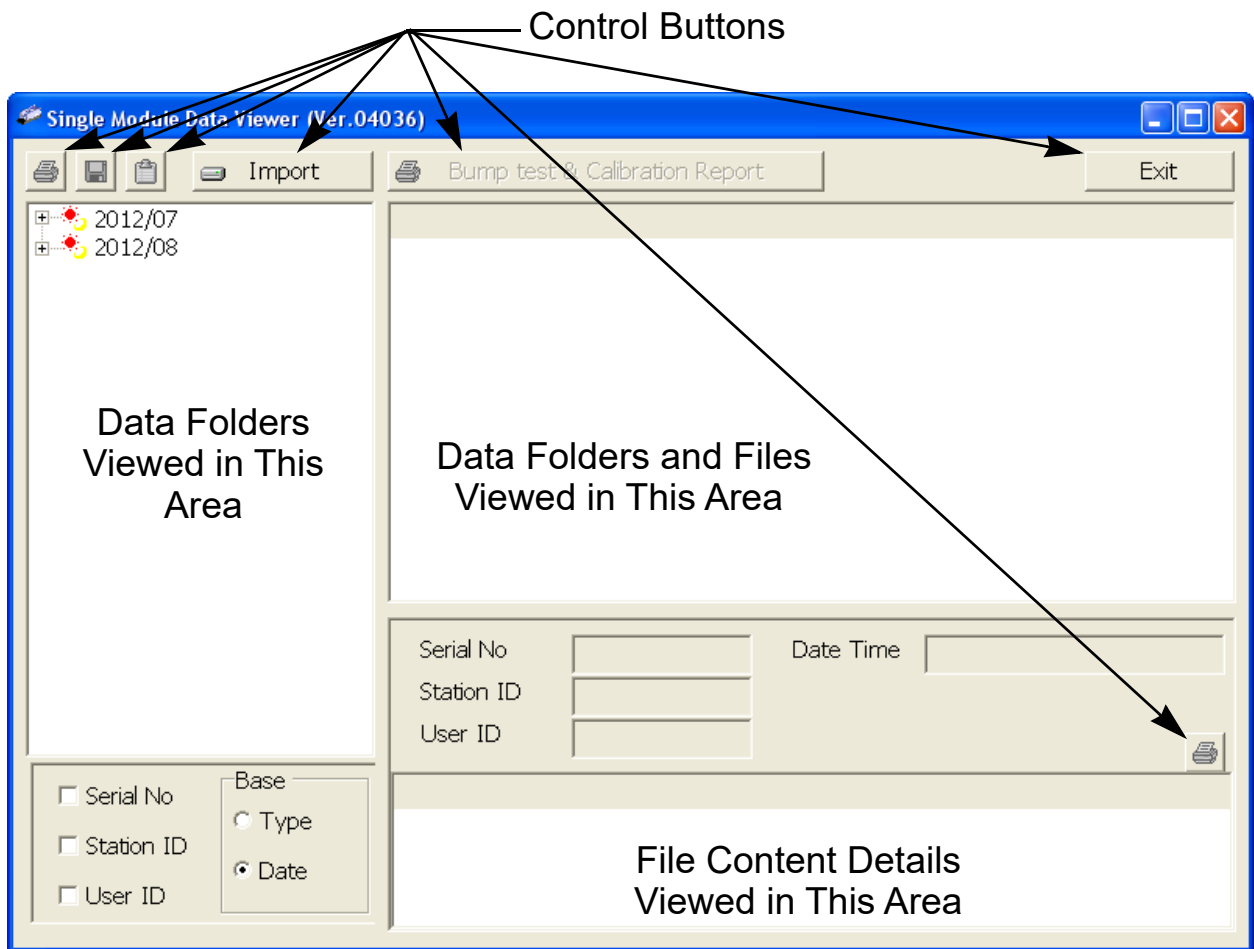

Figure 21: Data Viewing Window

All of the operations that can be performed in the Single Module Data Viewer Program can be executed from the data viewing window. There are function buttons along the top of the window and one in the lower right that initiate the various operations. The upper left side of the window displays the contents of the database. The lower left corner of the window has selection boxes that allow you to organize the data. The upper right side of the window shows the contents of the item selected in the upper left side, and the lower right side indicates the contents of the item selected in the area above it. In the example above, the data is organized by date.

You can do the following in the data viewing window:

- Import files into the database that were created by an SDM-2009
- View the bump test and calibration data saved in the database.
- Delete data.
- Print bump test or calibration results (pass or fail indication only).
- Copy bump test or calibration records to the clipboard or to a particular location on your computer or network.
- Print a bump test or calibration report that includes the results and all gas readings.

Importing Files Into the Database

The files generated by the SDM-2009 are structured to be imported into the Single Module Data Viewer Program database. To import data files into the database, do the following:

1. While in the Data Viewing Window, click the **Import** button. The Import Window will appear.

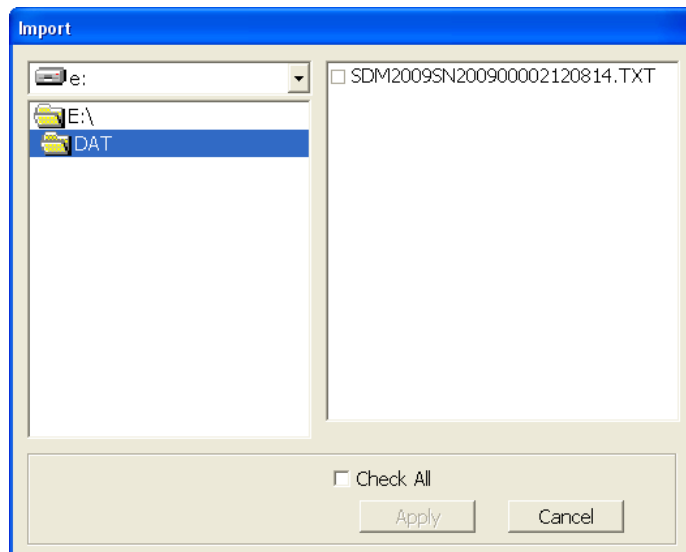

Figure 22: Import Window

2. Navigate to the location of the files that you want to import into the database.
3. Select the files that you want to import or use the Check All box to select all of the files.
4. Click the **Apply** button. A window will appear for a few seconds indicating that the file or files are being imported.
5. The files are now added to the database.

Organizing the Data

When viewing the data, it can be organized in two ways:

1. Base View Format

In base view format, neither of the Serial No, Station ID, or User ID selection boxes in the lower left of the window are selected and the Base box appears next to these selection boxes with two radio buttons. The data can be organized by either the data Type (bump test and calibration data) or by Date (year and month). The example below shows the data organized by Type.

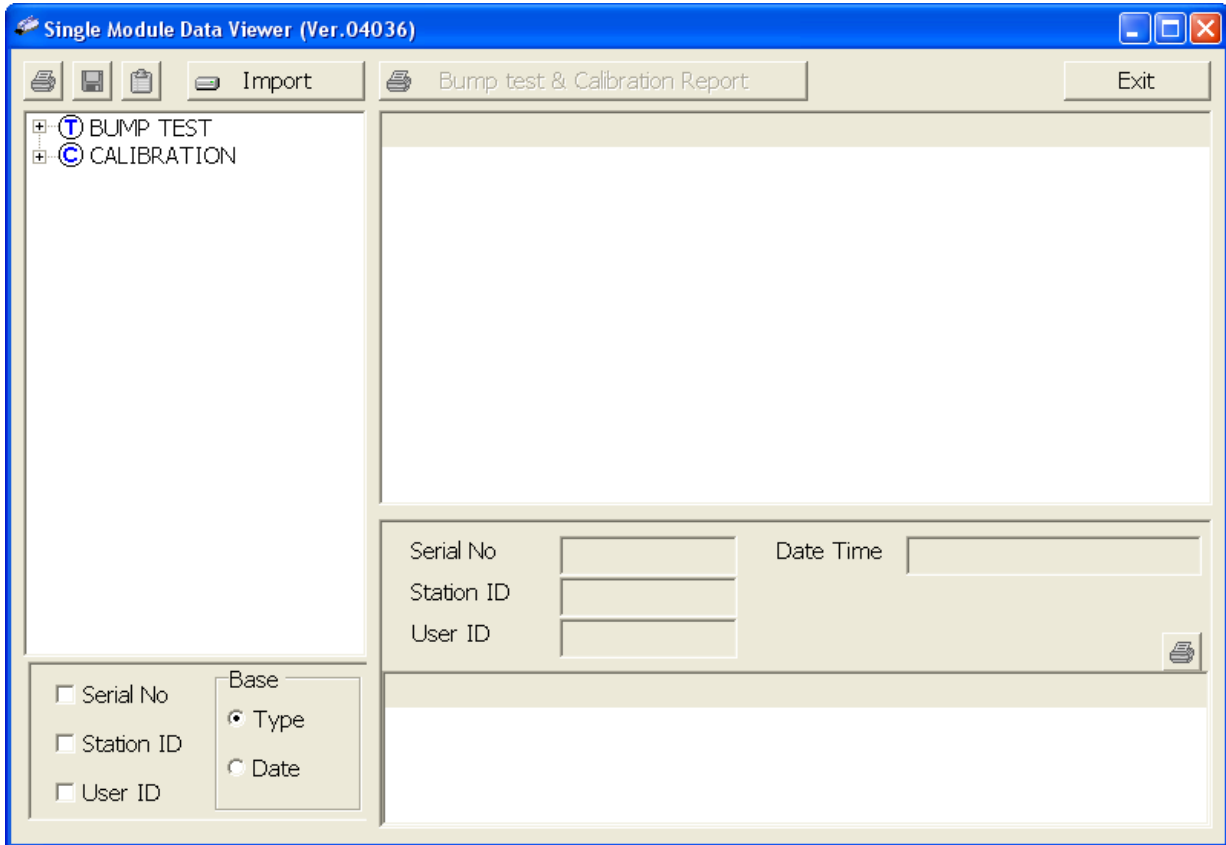

Figure 23: Data in Base Viewing Format, Type

2. ID View Format

In ID view format, the data can be organized by one or more of the following items depending on which selection box or boxes in the lower left corner of the data viewing window are selected:

- Serial Number
- Station ID
- User ID

If any of these boxes is selected, the Base box disappears. The example below shows the data organized by serial number.

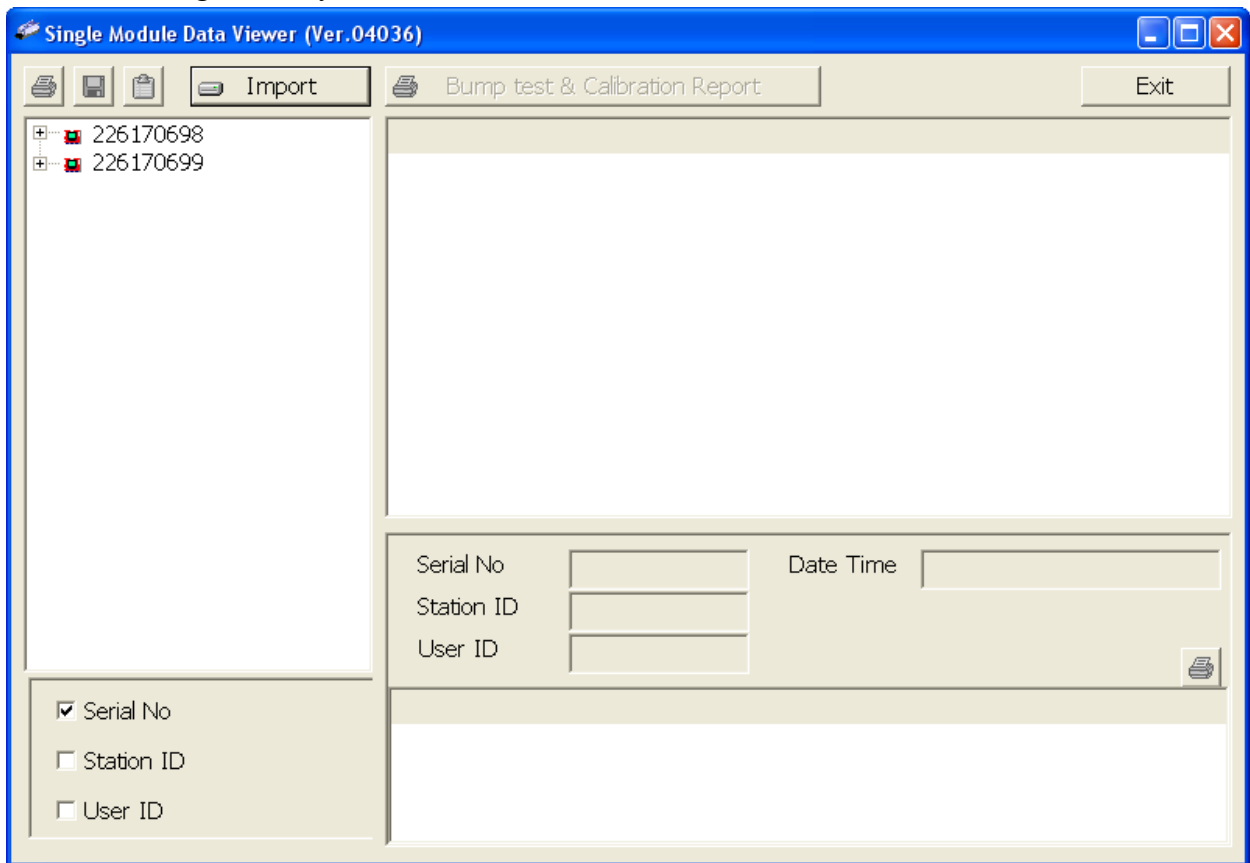

Figure 24: Data in ID Viewing Format

Viewing the Data

Once you have selected how you want to organize the data:

1. Click the expanded view symbol (+) next to an item, folder or icon, in the left side of the data viewing window or double click the item to view the contents below it. Single click on an item to view the contents in the right side of the window. If an item is expanded and you want to close it, click the (-) symbol next to the item or double click it.

- When an item no longer has a (+) or (-) symbol next to it, single click it and the contents of the item will be shown on the right side of the window.
- If you are viewing data in base view format with the data organized by type, expand the item, bump test or calibration, you wish to view. Icons organized by year/month will appear below the bump test or calibration icon. Click on the item whose contents you wish to see. The bump test or calibration files will be shown in the upper right side of the data view window.

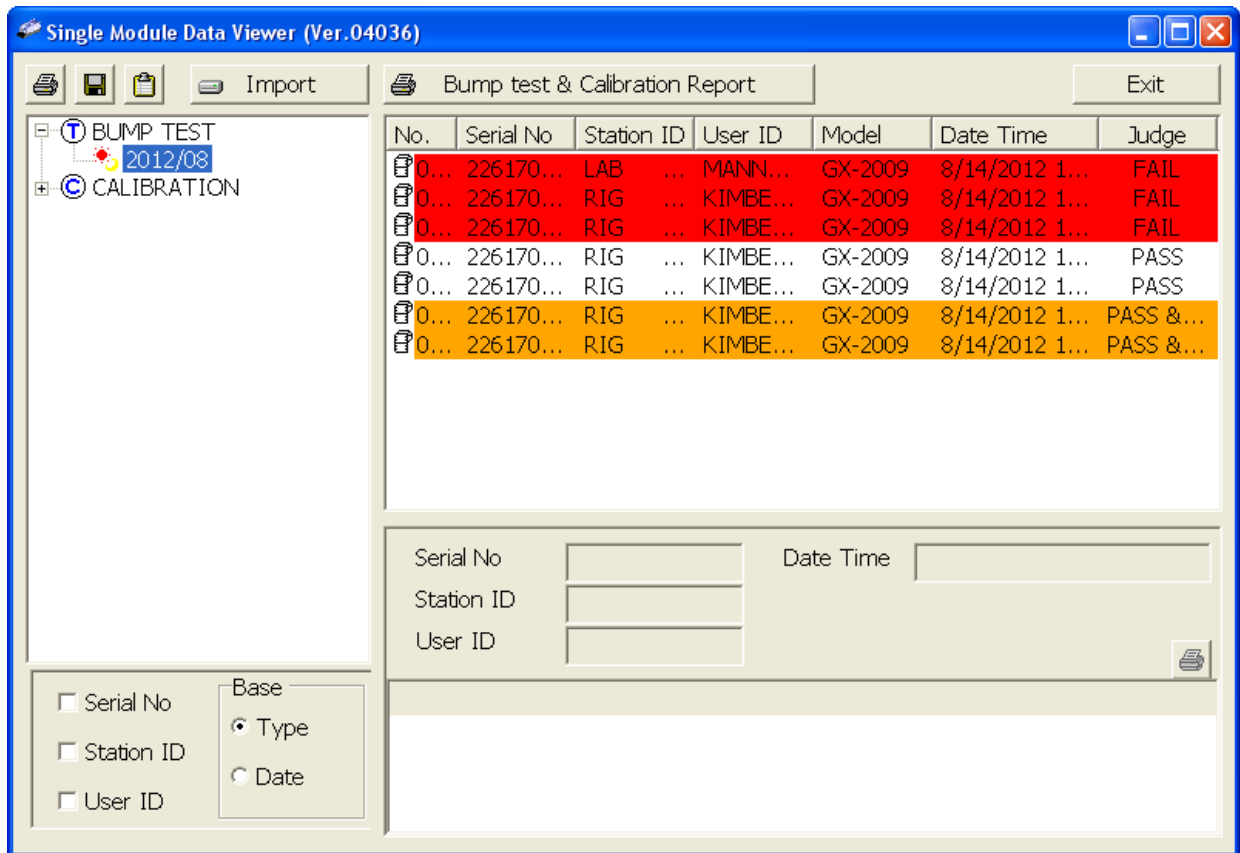

Figure 25: Calibration/Bump Test Files in Base View Format by Type

If you organize the data by date, then folders organized by year/month appear in the left side of the window. Expand the folder you want to see and click on the calibration or bump test folder. The calibration or bump test files will appear in the upper right side of the window.

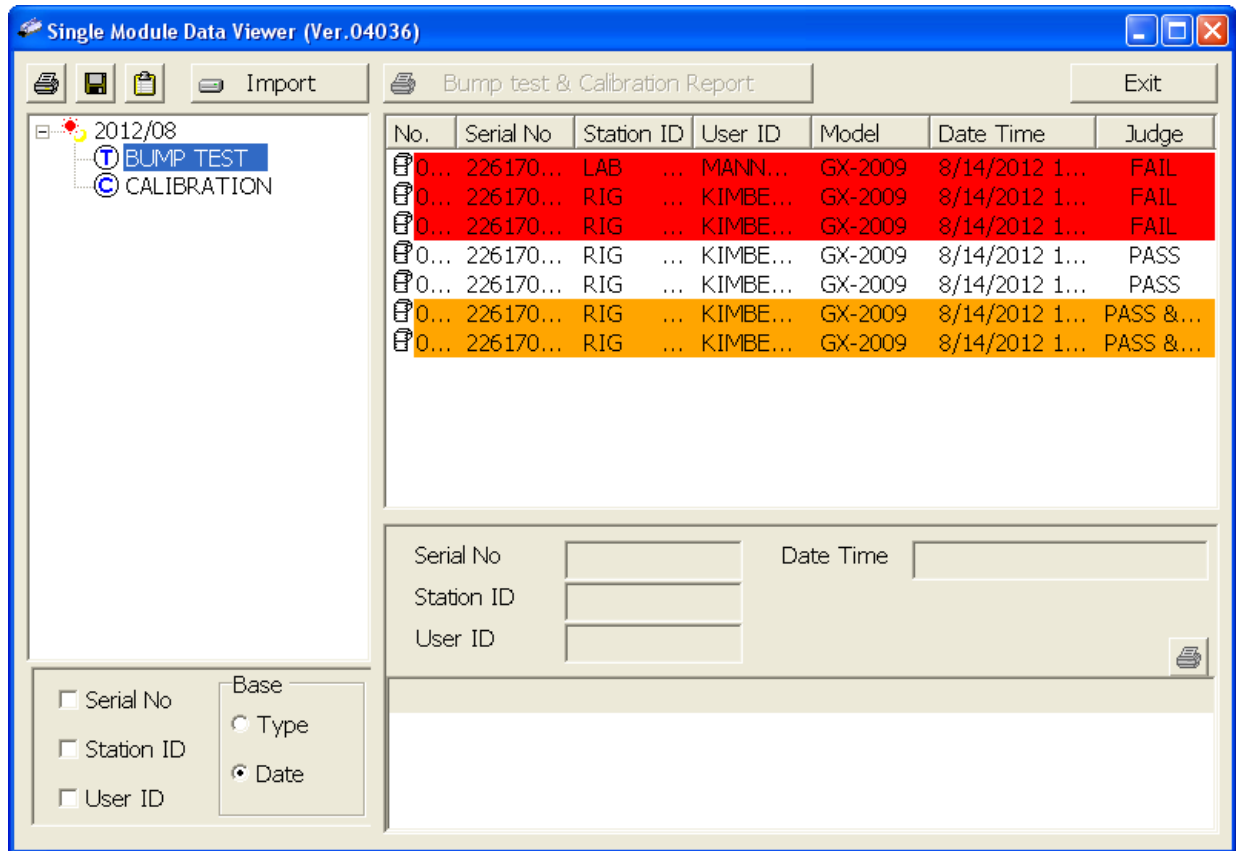

Figure 26: Calibration/Bump Test Files in Base View Format by Date

If you are viewing data in ID view format, expand the folders in the left side of the window until the bump test or calibration folder you wish to view is visible. Expand the folder by clicking the (+) symbol next to it. Folders organized by year/month will be listed below the calibration or bump test folder. Click the folder whose contents you want to view and the calibration or bump test files in it will be shown in the upper right side of the data view window. The example below is organized by serial number.

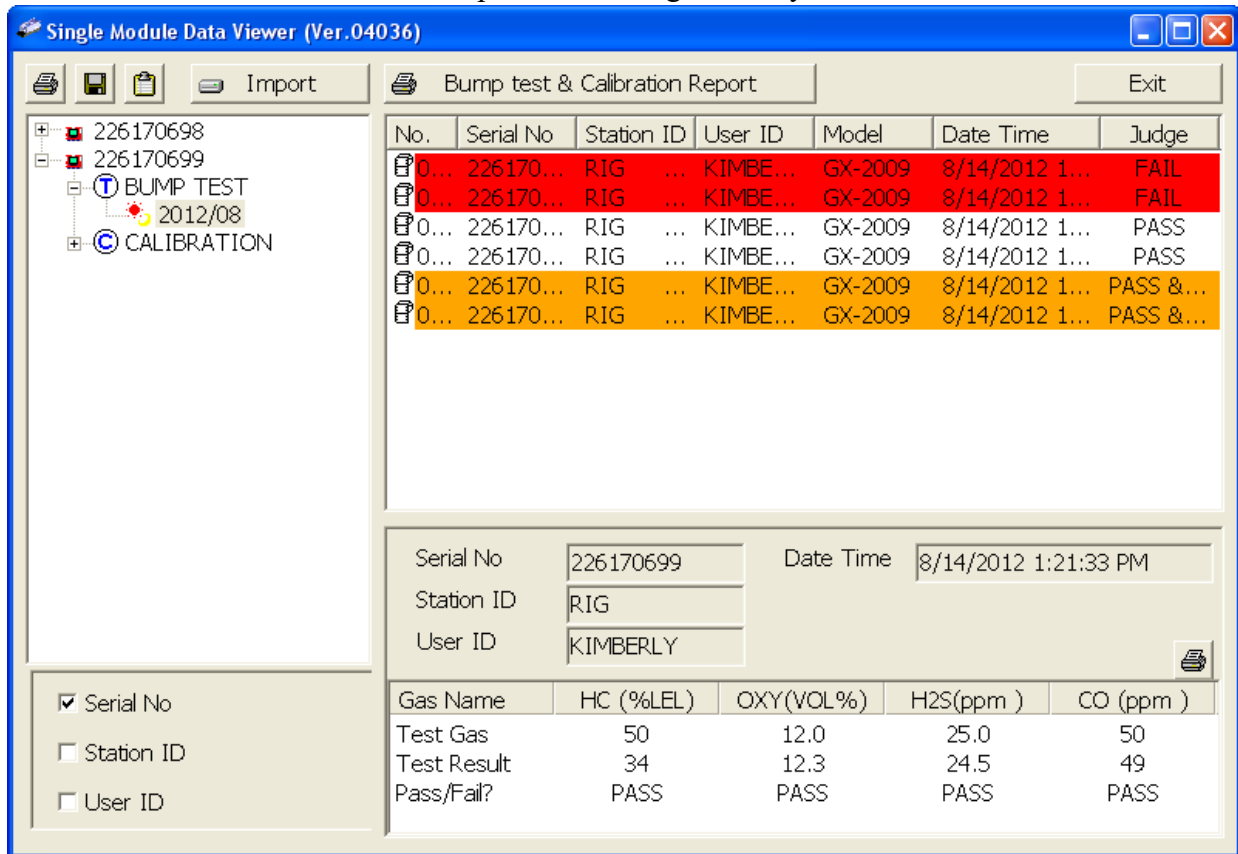

Figure 27: Calibration/Bump Test Files in ID View Format

- Files that record a failed calibration or bump test on all channels are highlighted in red. Files that record a calibration or bump test where not all channels passed are highlighted in orange.
- To view the file contents, click on the file in the upper right part of the data view window that you wish to view. The contents in the file will appear in the lower right part of the window. The contents include the instrument's serial number, station ID, user ID, bump test or calibration time, test gas, and gas readings during the operation.
- To print the files as they appear in the upper right part of the data view window, click the print button in the upper left corner of the window. A dialog box will appear confirming if you want to print. Click **OK**.
- To print only the pass or fail result of all files in the upper right window, click the **Bump test & Calibration Report** button above the files. A dialog box will appear showing the selected printer and confirming if you want to print. Verify that the selected printer is correct and click **OK**.

8. To print the complete results, pass/fail and gas readings, of one of the files in the upper right part of the data view window, click on one of the files to select it and then click the print button that appears above the file details in the lower right. A dialog box will appear showing the selected printer and confirming if you want to print. Verify that the selected printer is correct and click **OK**.
9. To save files as they appear in the upper right part of the data view window, click the **Save To File** button to the right of the print button in the upper left corner of the window. The **Save To File** button has a floppy disk icon in it. A “Save As” dialog box will appear for you to specify the filename, file location, and file type. Select the **Text files (*.csv)** choice to save the information as a comma separated value file that may be opened with a spreadsheet program such as Microsoft Excel.
10. To save files to the clipboard as they appear in the upper right part of the data view window, click the **Copy To Clipboard** button. The **Copy To Clipboard** button has a clipboard icon in it. The file will be saved to the clipboard. It can then be pasted into a document by using the Paste command in an application.

Deleting Data

You can delete an instrument, bump test data, or calibration data in the data view window. The delete function is password protected to avoid accidental deletion of instruments or data. To delete an instrument or data, perform the following:

1. Find the item you wish to delete and right click it. A window will appear that says “Delete(D) Change Password(C)”.

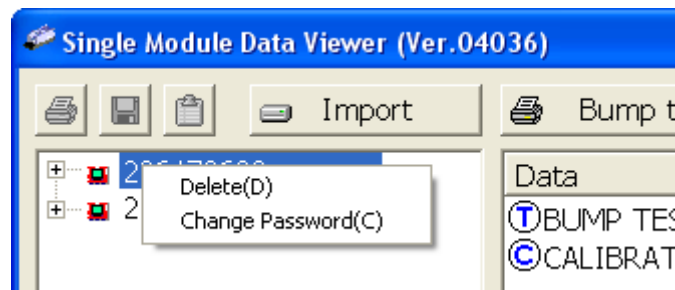

2. Click on “Delete(D)”. A password entry window will appear.

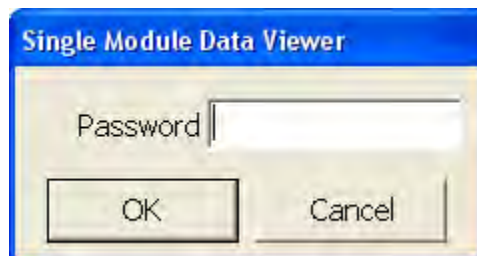

3. Enter the password and click **OK**. The factory set password is “ABCDE” and is case sensitive. A confirmation window will appear.

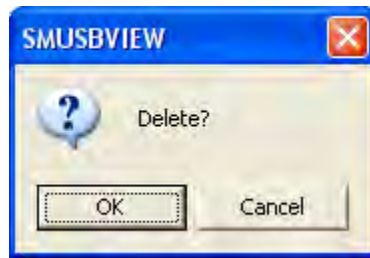

4. Click **OK** to complete the deletion of the selected item.

Changing the Password

The factory password is “ABCDE” and is case sensitive. You can change the password in the data view window. To change the password perform the following:

1. Right click in the upper right or upper left part of the data view window. A window will appear that says “Delete(D) Change Password(C)”.

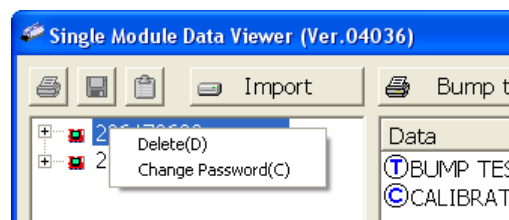

2. Click on “Change Password(C)”. A window will appear prompting you for the current password.

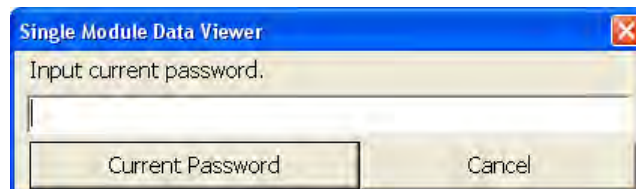

3. Enter the current password and click the **Current Password** button. A window will appear prompting you for the new password.

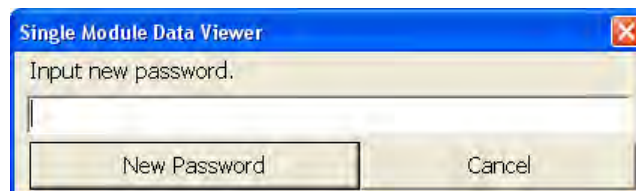

4. Enter the new password and click the **New Password** button. A confirmation window will appear prompting you for the new password again.



5. Enter the new password again and click the **Confirm New Password** button. A window will appear indicating that the password has been changed.



6. Click **OK** to complete the password update.

Exiting the Program

To exit the Single Module Data Viewer Program, do the following:

1. Click the **Exit** button in the upper right corner of the data view window. A confirmation window will appear.
2. Click the **OK** button to exit the program or the **Cancel** button to return to the program.

Chapter 6: Spare Parts List

Table 8: Spare Parts List

Part Number	Description
06-1248RK	Polyurethane tubing, 5/16-inch OD x 3/16-inch ID, for connecting to inlet fittings
06-1248RK-03	3 foot length of 5/16-inch OD x 3/16-inch ID, for connecting calibration cylinder to inlet fittings
06-1254RK	Polyurethane tubing, 7/16-inch OD x 5/16-inch ID, for exhaust tube, 10 feet maximum
17-0604RK	T-fitting for GAS manifold
17-0611RK	T-fitting for exhaust manifold
32-0504RK	Check valve for exhaust fitting (when manifolded)
33-0167RK	Particle air filter replacement, CF-8369
49-0115RK	Single-port AC adapter
49-2058RK-04	4-port AC adapter
71-0261RK	Operator's Manual, SDM-2009 Docking Station Standalone Configuration (this document)
71-0262RK	Operator's Manual, SDM-2009 Docking Station PC Controller Configuration
71-8007RK	Product CD for SDM-GX Series, includes Single Module Data Viewer Program
81-0012RK-01	Calibration cylinder, 50 %LEL CH ₄ in air, 34 liter steel
81-0012RK-03	Calibration cylinder, 50 %LEL CH ₄ in air, 103 liter
81-0018RK-01	Calibration cylinder, 50 %LEL isobutane in air, 34 liter steel
81-0018RK-03	Calibration cylinder, 50 %LEL isobutane in air, 103 liter
81-0076RK	Zero air cylinder, 17 liter
81-0076RK-01	Zero air cylinder, 34 liter steel
81-0076RK-03	Zero air cylinder, 103 liter
81-0090RK-01	Three-gas calibration cylinder, 50% LEL CH ₄ /12% O ₂ /50 ppm CO, 34 liter steel

Table 8: Spare Parts List

Part Number	Description
81-0090RK-03	Three-gas calibration cylinder, 50% LEL CH ₄ /12% O ₂ /50 ppm CO, 103 liter steel
81-0154RK-02	Four-gas calibration cylinder, 50% LEL CH ₄ /12% O ₂ /50 ppm CO/25 ppm H ₂ S, 58 liter aluminum
81-0154RK-04	Four-gas calibration cylinder, 50% LEL CH ₄ /12% O ₂ /50 ppm CO/25 ppm H ₂ S, 34 liter aluminum
81-0158RK-02	Four-gas calibration cylinder, 50% LEL Isobutane/12% O ₂ /50 ppm CO/25 ppm H ₂ S, 58 liter aluminum
81-0158RK-04	Four-gas calibration cylinder, 50% LEL Isobutane/12% O ₂ /50 ppm CO/25 ppm H ₂ S, 34 liter aluminum
81-1054RK	Demand flow regulator, for 34 liter aluminum, 58 liter, and 103 liter cylinders (cylinders with internal threads)
81-1055RK	Demand flow regulator, for 17 liter and 34 liter steel cylinders (cylinders with external threads)
81-SDM2009	Docking Station for GX-2009