



**INSTRUMENTS**

**EAGLE 2**  
**Operator's Manual**

*Part Number: 71-0154RK*

*Revision: CC*

*Released: 3/12/19*

# **WARNING**

Read and understand this instruction manual before operating instrument. Improper use of the gas monitor could result in bodily harm or death.

Periodic calibration and maintenance of the gas monitor is essential for proper operation and correct readings. Please calibrate and maintain this instrument regularly! Frequency of calibration depends upon the type of use you have and the sensor types. Typical calibration frequencies for most applications are between 1 and 3 months, but can be required more often or less often based on your usage.

---

# Table of Contents

<b>Chapter 1: Introduction</b> .....	<b>10</b>
Overview .....	10
About the EAGLE 2 .....	10
Specifications .....	12
About this Manual .....	13
<b>Chapter 2: Description</b> .....	<b>14</b>
Overview .....	14
Instrument Description .....	14
<i>Case</i> .....	16
<i>Sensors</i> .....	16
<i>LCD</i> .....	17
<i>Control Buttons</i> .....	17
<i>Printed Circuit Boards (PCBs)</i> .....	18
<i>Alarm LEDs</i> .....	19
<i>Infrared Communications Port</i> .....	19
<i>Buzzer</i> .....	20
<i>Battery Case &amp; Batteries</i> .....	20
<i>Flow System</i> .....	20
Standard Accessories .....	21
<i>Shoulder Strap</i> .....	21
<i>Hose and Probe</i> .....	21
Optional Accessories .....	23
<i>Rechargeable Ni-MH Batteries</i> .....	23
<i>Battery Chargers</i> .....	23
<i>Optional Probes</i> .....	24
<i>External Dilution Fittings</i> .....	26
<b>Chapter 3: Operation</b> .....	<b>27</b>
Overview .....	27
Start Up .....	27
<i>Turning On the EAGLE 2</i> .....	27
<i>Performing a Demand Zero</i> .....	31
<i>Turning Off the EAGLE 2</i> .....	32
Using the Battery Charger for Continuous Operation .....	32
Measuring Mode, Normal Operation .....	33
<i>Monitoring an Area</i> .....	33
<i>Using Optional Sample Hoses</i> .....	34
<i>Using Exhaust Tubing</i> .....	34
<i>Combustible Gas Detection</i> .....	34
<i>Monitoring Combustible Gas in the PPM or %Volume Ranges</i> .....	36
Measuring Mode, Alarms .....	38
<i>Alarm Indications</i> .....	38
<i>Resetting and Silencing Alarms</i> .....	39
<i>Responding to Alarms</i> .....	40

Display Mode .....	41
<i>Tips for Using Display Mode</i> .....	42
<i>Peak Screen</i> .....	42
<i>Battery Voltage Screen</i> .....	43
<i>Gas Display Screen</i> .....	43
<i>Catalytic (LEL) Sensor Screen</i> .....	44
<i>Methane Elimination Mode Screen</i> .....	44
<i>Relative Response Screen</i> .....	44
<i>STEL Screen</i> .....	46
<i>TWA Screen</i> .....	46
<i>View Alarm Settings Screen</i> .....	47
<i>Select User ID Screen</i> .....	48
<i>Select Station ID Screen</i> .....	49
<i>Time in Operation Screen</i> .....	50
<i>Date/Time Screen</i> .....	51
<i>Data Logging Screen</i> .....	51
Data Logging .....	52
<b>Chapter 4: Calibration Mode .....</b>	<b>54</b>
Overview .....	54
Calibration Supplies and Equipment .....	55
Entering Calibration Mode .....	56
Calibrating Using the Auto Calibration Method .....	56
<i>Setting the Fresh Air Reading</i> .....	56
<i>Performing a Span Adjustment in Auto Calibration</i> .....	58
Calibrating Using the Single Calibration Method .....	62
<i>Setting the Fresh Air Reading</i> .....	62
<i>Performing a Span Adjustment in Single Calibration</i> .....	63
<b>Chapter 5: Maintenance .....</b>	<b>67</b>
Overview .....	67
Troubleshooting .....	67
Replacing or Recharging the Batteries .....	69
<i>Replacing the Batteries</i> .....	69
<i>Recharging the Ni-MH Batteries</i> .....	70
Replacing the Hydrophobic Probe's Particle Filter and Hydrophobic Filter Disk .....	72
Replacing the Hydrophobic Filter .....	73
Replacing the Charcoal Filter .....	75
Checking the Combustible Gas Sensor's Condition .....	76
Replacing a Sensor .....	76
General Parts List .....	79
<b>Appendix A: Calibrating with a Sample Bag .....</b>	<b>82</b>
Overview .....	82
Calibration Supplies and Equipment .....	82
Entering Calibration Mode .....	83
Calibrating Using the Auto Calibration Method .....	84
<i>Setting the Fresh Air Reading</i> .....	84
<i>Performing a Span Adjustment in Auto Calibration</i> .....	85

Calibrating Using the Single Calibration Method .....	89
<i>Setting the Fresh Air Reading</i> .....	89
<i>Performing a Span Adjustment in Single Calibration</i> .....	90
Parts List .....	94
<b>Appendix B: Setup Mode .....</b>	<b>95</b>
Overview .....	95
Tips for Using Setup Mode .....	96
Using Setup Mode .....	96
<i>Setting the Date and Time</i> .....	97
<i>Setting the Date Format</i> .....	98
<i>Setting the Battery Type</i> .....	98
<i>Configuring the Channels</i> .....	99
<i>Configuring the Combustible Gas</i> .....	101
<i>Setting the Catalytic Detection Units</i> .....	105
<i>Updating the Relative Response Setting</i> .....	106
<i>Updating the Alarm Point Settings</i> .....	106
<i>Updating the Alarm Latching Setting</i> .....	108
<i>Updating the Alarm Silence Setting</i> .....	108
<i>Turning the User/Station ID Function On or Off</i> .....	109
<i>Updating the Autocal Values</i> .....	109
<i>Updating the Backlight Delay Setting</i> .....	110
<i>Updating the Auto Fresh Air Setting</i> .....	110
<i>Updating the Data Log Interval Setting</i> .....	111
<i>Updating the Data Log Overwrite Setting</i> .....	111
<i>Updating the Data Log Memory Setting</i> .....	112
<i>Updating the LCD Contrast Setting</i> .....	112
<i>Updating the Calibration Reminder Setting</i> .....	113
<i>Updating the Calibration Past Due Action Setting</i> .....	113
<i>Updating the Calibration Interval</i> .....	114
<i>Updating LC/BH Mode Setting</i> .....	114
<i>Setting the Bar Hole Measurement Time</i> .....	115
<i>Zero Follower Settings</i> .....	115
<i>Zero Suppression Settings</i> .....	115
<i>Updating the Confirmation Alert Setting</i> .....	115
<i>Turning the Password Function On or Off</i> .....	116
<i>Restoring the Default Settings</i> .....	117
<i>Updating the Lunch Break Setting</i> .....	118
<i>Updating the Span Factor Setting</i> .....	119
<i>Updating the Language Setting</i> .....	119
<i>Exiting Setup Mode</i> .....	120
<b>Appendix C: Sub PCBs .....</b>	<b>121</b>
Overview .....	121
Description .....	121
Channel Setup and Sub PCBs .....	122
<i>Sub PCBs and CONFIGURE CHANNELS</i> .....	122
<i>Sub PCBs and CONFIGURE GASES</i> .....	123

<b>Appendix D: PID Sensors</b> .....	<b>125</b>
Overview .....	125
Description .....	125
<i>PID Sensor and Sensor Adapter</i> .....	126
<i>PID Sub PCB</i> .....	126
<i>PID Probe</i> .....	127
Start Up and Normal Operation .....	127
PID Relative Response Feature .....	128
<i>PID Sensor Relative Response Screen in Display Mode</i> .....	129
PID Calibration .....	131
<i>Calibrating with a 4-Gas Cylinder and a PID Cylinder</i> .....	131
<i>Calibrating with a 5-Gas Cylinder</i> .....	139
Maintenance .....	146
<i>Troubleshooting</i> .....	146
<i>Cleaning the PID Sensor's Lamp</i> .....	146
<i>Replacing PID Sensor's Lamp</i> .....	150
<i>Replacing Electrode Stack</i> .....	153
<i>Replacing the PID Sensor</i> .....	156
Configuring the PID Gas in Setup Mode .....	157
Parts List .....	162
<b>Appendix E: ESM-01 Toxic Sensors</b> .....	<b>164</b>
Overview .....	164
Description .....	164
<i>ESM-01 Sensor</i> .....	165
<i>ESM-01 Sub PCB</i> .....	165
Start Up and Normal Operation .....	166
ESM-01 Calibration .....	166
<i>Calibrating with a 4-Gas Cylinder and an ESM-01 Cylinder</i> .....	166
<i>Calibrating with a 5-Gas Cylinder</i> .....	174
Maintenance .....	180
<i>Replacing the ESM-01 Sensor</i> .....	180
<i>Replacing the H<sub>2</sub>S Scrubber in the SO<sub>2</sub> and HCN Sensors</i> .....	181
Parts List .....	183
<b>Appendix F: TC Sensors</b> .....	<b>184</b>
Overview .....	184
Description .....	184
<i>TC Sensor</i> .....	185
<i>TC Sub PCB</i> .....	185
Start Up and Normal Operation .....	186
Catalytic (LEL) Sensor Screen .....	186
TC Calibration .....	187
Maintenance .....	193
<i>Replacing the TC Sensor</i> .....	193
Configuring the TC Gas in Setup Mode .....	195
Parts List .....	199

<b>Appendix G: Infrared Carbon Dioxide Sensors</b> .....	<b>200</b>
Overview .....	200
Description .....	200
<i>Infrared Carbon Dioxide Sensor</i> .....	201
<i>Infrared Sub PCB</i> .....	201
<i>CO<sub>2</sub> Scrubber</i> .....	202
Start Up and Normal Operation .....	202
<i>Performing a Demand Zero for Carbon Dioxide Sensors</i> .....	203
Infrared Carbon Dioxide Calibration .....	203
Maintenance .....	211
<i>Replacing the IR CO<sub>2</sub> Sensor or Changing Sensor Type</i> .....	211
Parts List .....	213
<b>Appendix H: Infrared Methane Sensors</b> .....	<b>214</b>
Overview .....	214
<i>Target Gases</i> .....	214
Description .....	215
<i>Infrared Methane Sensor</i> .....	215
<i>Infrared Sub PCB</i> .....	216
Start Up and Normal Operation .....	216
<i>Detection Ranges</i> .....	216
Catalytic (LEL) Sensor Screen .....	216
Infrared Methane Calibration .....	217
Maintenance .....	224
<i>Replacing the IR Methane Sensor</i> .....	224
Parts List .....	225
<b>Appendix I: Infrared Hydrocarbon Sensor</b> .....	<b>226</b>
Overview .....	226
<i>Target Gases</i> .....	226
Description .....	226
<i>Infrared Hydrocarbon Sensor</i> .....	227
<i>Infrared Sub PCB</i> .....	227
Start Up and Normal Operation .....	227
<i>0-100 %LEL/2.0-30.0 %vol Autoranging</i> .....	227
Catalytic (LEL) Sensor Screen .....	228
Infrared Hydrocarbon Calibration .....	228
Maintenance .....	235
<i>Replacing the IR Hydrocarbon Sensor</i> .....	235
Parts List .....	236
<b>Appendix J: Methane Elimination Mode</b> .....	<b>237</b>
Overview .....	237
Monitoring in Methane Elimination Mode .....	237
Calibration .....	240

<b>Appendix K: Using the EAGLE 2 in Bar Hole Mode</b> .....	<b>241</b>
Overview .....	241
Start Up, Bar Hole Mode .....	241
<i>Turning on EAGLE 2, Bar Hole Mode</i> .....	241
<i>Performing a Demand Zero, Bar Hole Mode</i> .....	245
Bar Hole Testing .....	246
<i>Performing a Bar Hole Test</i> .....	246
<i>Turning off the EAGLE 2, Bar Hole Mode</i> .....	248
<b>Appendix L: Using the EAGLE 2 in Leak Check Mode</b> .....	<b>249</b>
Overview .....	249
Start Up, Leak Check Mode .....	249
<i>Turning On the EAGLE 2, Leak Check Mode</i> .....	249
<i>Performing a Demand Zero, Leak Check Mode</i> .....	254
Leak Testing .....	254
<i>Locating a Leak</i> .....	254
<i>Turning the Buzzer On and Off In Leak Check Mode</i> .....	255
<i>Turning Off the EAGLE 2, Leak Check Mode</i> .....	255
<b>Appendix M: EAGLE 2 Tank Tester Model</b> .....	<b>256</b>
Description .....	256
<i>Float Probe Assembly</i> .....	257
<i>Dilution Fitting (1:1)</i> .....	257
Start Up .....	258
Alarms .....	259
Calibration .....	260
Parts List .....	260
<b>Appendix N: Using the EAGLE 2 in Inert Mode</b> .....	<b>261</b>
Description .....	261
Alarms .....	261
Start Up .....	263
Operation .....	265
<b>Appendix O: Transformer Gas Tester Model</b> .....	<b>266</b>
Description .....	266
Operation .....	266
Alarms .....	267
Parts List .....	267
<b>Appendix P: Internal Dilution Models</b> .....	<b>268</b>
Description .....	268
Calibration .....	268
<b>WARNING:</b> <i>Understand manual before operating. Substitution of components may impair intrinsic safety. To prevent ignition of a hazardous atmosphere, batteries must only be changed or charged in an area known to be nonhazardous. Not tested in oxygen enriched atmospheres (above 21%).</i>	

**NOTE:** RKI Instruments, Inc. recommends that you refer to ISA-RP12.13, Part II-1987 or an equivalent international recommended practice for guidance in the use of combustible gas detection instruments.

# Chapter 1: Introduction

---

## Overview

This chapter briefly describes the EAGLE 2 gas monitor. This chapter also describes the *EAGLE 2 Operator's Manual* (this document). Table 1 at the end of this chapter lists the specifications for the EAGLE 2.

---

## About the EAGLE 2

Using an advanced detection system consisting of up to six gas sensors, the EAGLE 2 sample draw gas monitor is capable of detecting the presence of combustible gas, oxygen (O<sub>2</sub>), carbon monoxide (CO), hydrogen sulfide (H<sub>2</sub>S), and various other toxic gases simultaneously. The EAGLE 2's rugged, reliable, and easy-to-use design makes it ideally suited for a wide range of applications, including sewage treatment plants, utility manholes, tunnels, hazardous waste sites, power stations, petrochemical refineries, mines, paper mills, drilling rigs, and fire fighting stations. The EAGLE 2 offers a full range of features including:

- Simultaneous monitoring of one to six gases. The standard configuration includes four sensors for combustible gas (%LEL, ppm, and %volume), oxygen, carbon monoxide (CO), and hydrogen sulfide (H<sub>2</sub>S).
- Choice of three operating modes:
  - Normal Mode for typical confined space or area monitoring. Normal Mode is the standard factory setting.
  - Bar Hole Mode for checking of bar holes when searching for underground gas leaks
  - Leak Check Mode for locating leaks in valves and piping
- Sample-drawing pump with up to 125 foot range
- Liquid crystal display (LCD) for complete and understandable information at a glance
- Ultrabright alarm LEDs
- Distinctive audible alarm for dangerous gas conditions or unit malfunction
- Microprocessor control for reliability, ease of use, and advanced capabilities
- Data logging functions (when used in Normal Mode)
- Alarm trend data (when used in Normal Mode)
- STEL and TWA (when used in Normal Mode) and over range alarms
- Peak readings (when used in Normal Mode)
- Built-in time function
- Lunch break feature
- RF shielded high impact plastic case
- CSA classified for Class I, Division I, Groups A, B, C, and D hazardous atmospheres

**WARNING:** *The Model EAGLE 2 detects oxygen deficiency, elevated levels of oxygen, combustible gases, carbon monoxide, and hydrogen sulfide, all of which can be dangerous or life threatening. When using the EAGLE 2, you must follow the instructions and warnings in this manual to assure proper and safe operation of the unit and to minimize the risk of personal injury. Be sure to maintain and periodically calibrate the EAGLE 2 as described in this manual.*

**NOTE:** ONLY THE COMBUSTIBLE GAS DETECTION PORTION OF THIS INSTRUMENT HAS BEEN ASSESSED FOR PERFORMANCE.

# Specifications

**Table 1: Standard Sensor Specifications**

	Combustible Gas, Methane (CH <sub>4</sub> ) Calibration Standard	Oxygen (O <sub>2</sub> )	Hydrogen Sulfide (H <sub>2</sub> S)	Carbon Monoxide (CO)
Detection Range	0 - 100 %LEL	0 - 40 volume%	0 - 100.0 ppm	0 - 500 ppm
Reading Increment	1 %LEL	0.1 volume %	0.5 ppm	1 ppm
Alarm 1 Factory Setting	10 %LEL*	19.5 volume %*	5.0 ppm*	25 ppm*
Alarm 2 Factory Setting	50 %LEL	23.5 volume %	30.0 ppm	50 ppm
STEL Alarm	n/a	n/a	5.0 ppm	200 ppm
TWA Alarm	n/a	n/a	1.0 ppm	25 ppm

\* When calibrating the EAGLE 2 with the Auto Calibration or the Single Calibration method, the calibration gas value must be equal to or higher than the alarm 1 setting. See "Updating the Alarm Point Settings" on page 106 for instructions to change the alarm points if necessary for the desired calibration gas value.

**Table 2: EAGLE 2 Specifications**

Sampling Method	Sample Draw
Response Time	T90 Within 30 Seconds
Display	Graphics LCD Display
Operating Temperature & Humidity	-20°C to 50°C/Below 85% RH (Without Condensation)
Indication Accuracy	<p><b>Combustible Gas (LEL), Catalytic Type Sensor</b></p> <ul style="list-style-type: none"> <li>-10°C to 40°C: 5% of full scale</li> <li>-20°C to 50°C: 6% of full scale</li> </ul> <p><b>Combustible Gas (ppm), Catalytic Type Sensor</b></p> <ul style="list-style-type: none"> <li>± 25 ppm or ± 5% of reading (whichever is greater)</li> </ul> <p><b>Oxygen</b></p> <ul style="list-style-type: none"> <li>± 0.5% O<sub>2</sub></li> </ul> <p><b>Hydrogen Sulfide</b></p> <ul style="list-style-type: none"> <li>± 5% of reading or ± 2 ppm H<sub>2</sub>S (whichever is greater)</li> </ul> <p><b>Carbon Monoxide</b></p> <ul style="list-style-type: none"> <li>± 5% of reading or ± 5 ppm CO (whichever is greater)</li> </ul>

Safety/ Regulatory	 186718 CSA classified as Intrinsically Safe. Exia. Class I, Groups A, B, C, & D. Temperature Code T3C.
Power Supply	<ul style="list-style-type: none"> <li>• Four C size alkaline batteries, standard</li> <li>• Four C size Ni-MH batteries, optional</li> </ul>
Continuous Operating Hours @ 25 °C	<ul style="list-style-type: none"> <li>• Alkaline Batteries: 16 Hours (Non Alarm Operation, Fully Charged)</li> <li>• Ni-MH Batteries: 18 Hours (Non Alarm Operation, Fully Charged)</li> </ul>
Case	High-impact Plastic, RF Shielded, Dust and Weather Proof
Standard Accessories	<ul style="list-style-type: none"> <li>• 5 foot hose</li> <li>• Hydrophobic probe</li> <li>• Shoulder Strap</li> </ul>
Optional Accessories	<ul style="list-style-type: none"> <li>• Rechargeable NiMH Batteries</li> <li>• 115 VAC Charger</li> <li>• 12 VDC Charger</li> <li>• Hoses of Various Lengths, See “General Parts List” on page 79.</li> <li>• Dilution Fitting (1:1 and 3:1)</li> <li>• Various Probes, See “General Parts List” on page 79</li> <li>• Product CD, includes Data Logger Management Program and Maintenance Data Loader Program</li> <li>• IrDA/USB Cable for connecting to a computer when using the Data Logger Management Program and Maintenance Data Loader Program (not needed if computer has an infrared port)</li> </ul>
Dimensions and Weight	Approximately 171(H) x 65(W) x 39(D) mm (5.6”H x 2.5”W x 1.5”D) Approximately 310 g (11 oz.)

## About this Manual

The *EAGLE 2 Operator’s Manual* uses the following conventions for notes, cautions, and warnings.

**NOTE:** Describes additional or critical information.

**CAUTION:** Describes potential damage to equipment.

**WARNING:** Describes potential danger that can result in injury or death.

# Chapter 2: Description

---

## Overview

This chapter describes the EAGLE 2 instrument and accessories.

---

## Instrument Description

The EAGLE 2 includes the case, sensors, LCD, control buttons, printed circuit boards, alarm LEDs, infrared communication port, buzzer, battery case and batteries, and flow system.

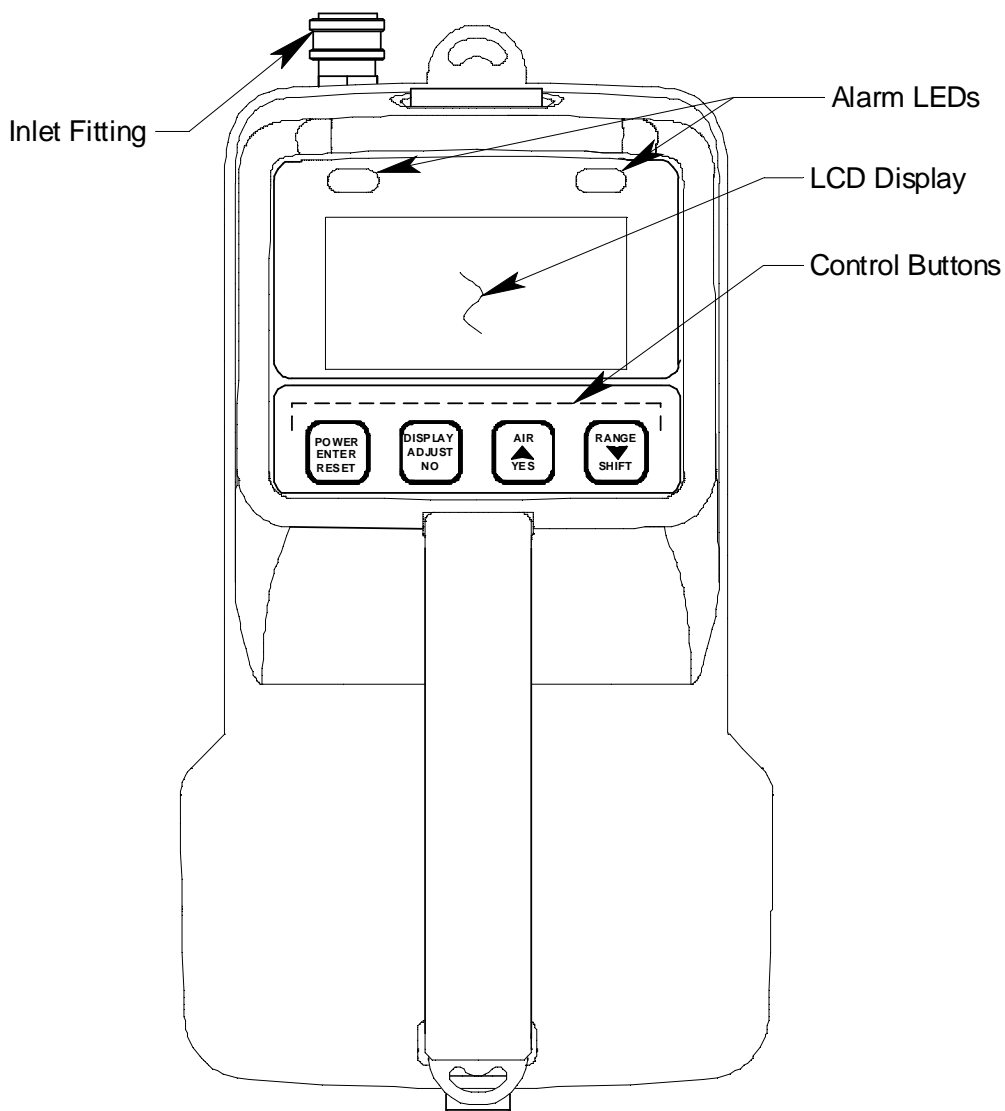

**Figure 1: Component Location, Top View**

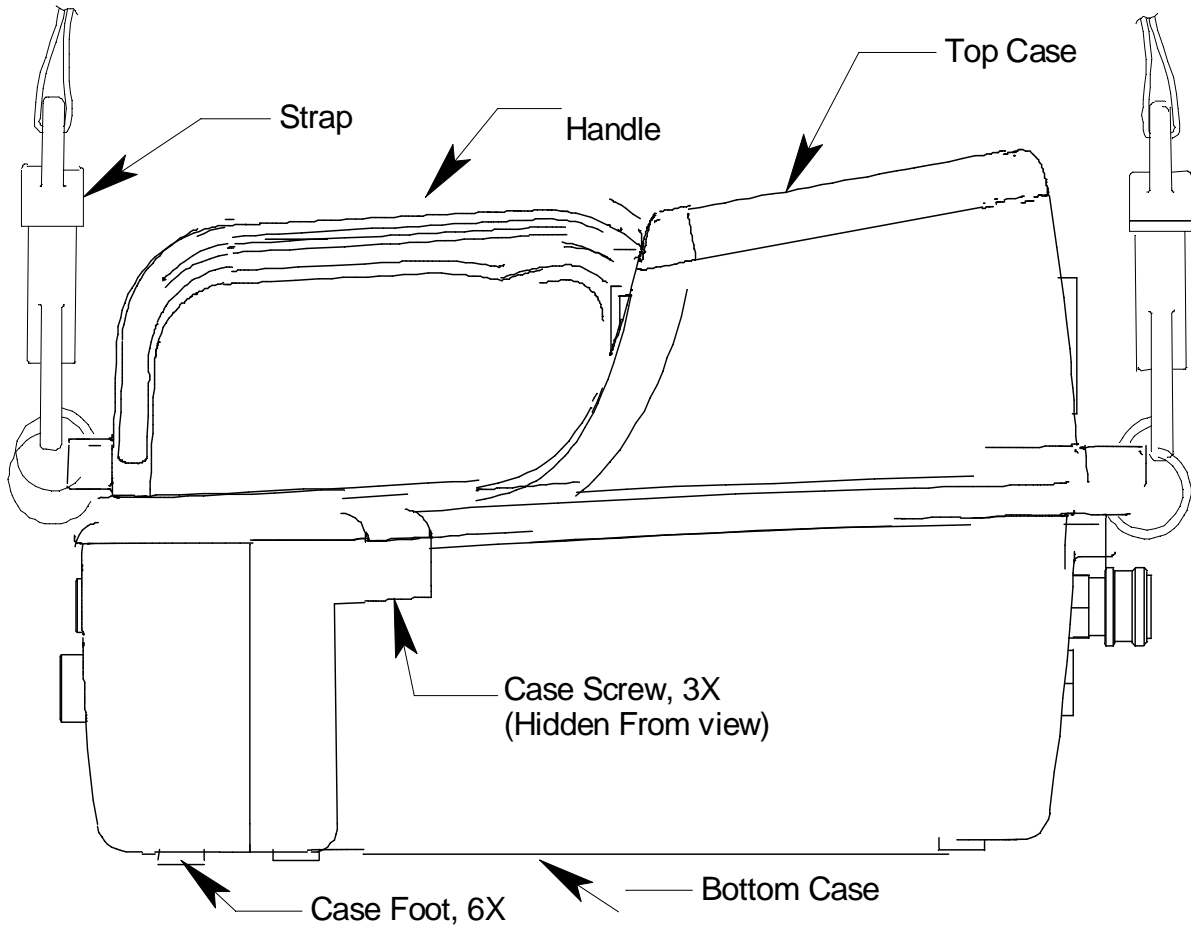

**Figure 2: Component Location, Side View**

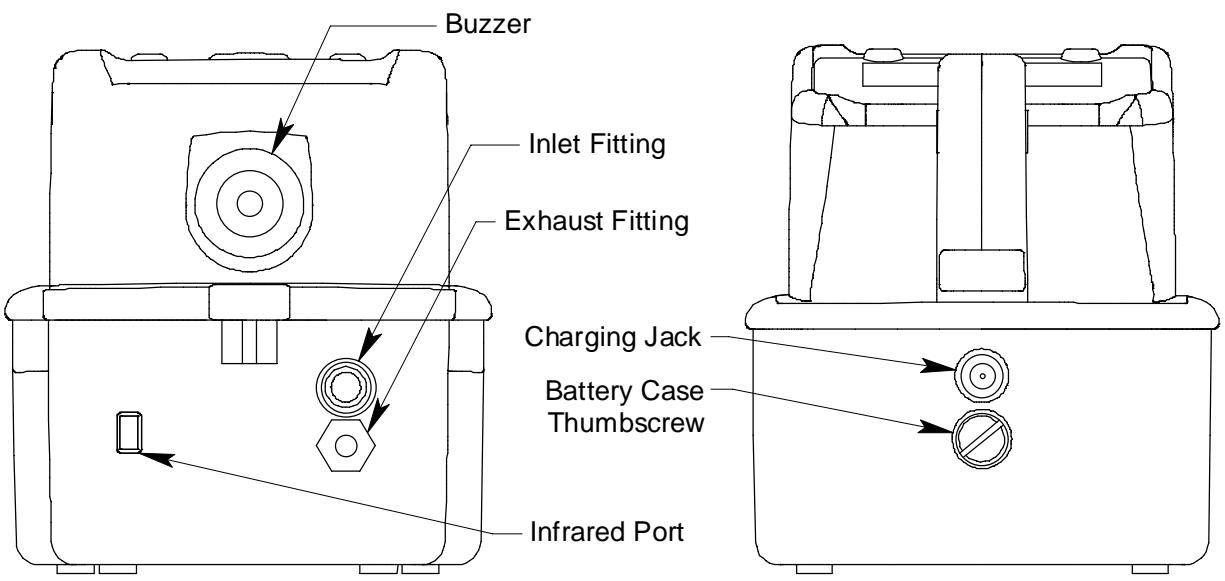

**Figure 3: Component Location, Front & Back**

## Case

The EAGLE 2's sturdy, high-impact plastic case is radio frequency (RF) resistant and is suitable for use in many environmental conditions, indoors and out. The case is dust proof and water resistant. It's two main components, the top case and bottom case, are held together with three screws located on the bottom case. The interface between the top case and bottom case is gasketed. A sturdy, well balanced handle on the top case allows you to hold the instrument comfortably. A clear plastic window is located on the top case to the front of the handle for viewing the LCD.

A removable battery case is located at the rear of the bottom case. A thumbscrew secures the battery case to the bottom case. The interface between the battery case and the bottom case is gasketed. Six raised feet on the bottom of the case, four on the bottom case and two on the battery compartment, raise the EAGLE 2 slightly from the surface on which it rests.

## Sensors

The EAGLE 2 uses up to six sensors to monitor combustible gas, oxygen (O<sub>2</sub>), carbon monoxide (CO), hydrogen sulfide (H<sub>2</sub>S), and various other toxic gases simultaneously. The sensors are located inside the EAGLE 2 bottom case and are installed in the flow chamber. The sensors described below are the four standard sensors. See "Appendix D: PID Sensors" for a description of the PID sensors, "Appendix E: ESM-01 Toxic Sensors" for a description of the ESM-01 toxic sensors, "Appendix F: TC Sensors" for a description of the TC sensors, "Appendix G: Infrared Carbon Dioxide Sensors" for a description of the IR CO<sub>2</sub> sensors, "Appendix H: Infrared Methane Sensor" for a description of the IR methane sensors, and "Appendix I: Infrared Hydrocarbon Sensor" for a description of the IR hydrocarbon sensor. The standard sensors use different detection principles as described below.

### ***Catalytic Combustible Gas Sensor (LEL Sensor)***

The catalytic combustible gas (LEL) sensor detects combustible gas in the %LEL range. It uses a catalytic element for detection. The reaction of gas with oxygen on the catalyst causes a change in the resistance of the element which changes the current flowing through it. The current is amplified by the EAGLE 2's circuitry, converted to a measurement of combustible gas concentration, and displayed on the LCD.

The LEL sensor housing includes a sintered metal flame arrestor on one end that allows gas to diffuse into the sensor. On the other end, five pins extend from the sensor. The sensor cable connects to these pins on one end and terminates in a four-position connector on the other end which plugs into the **HC** socket on the main PCB (see "Main PCB" on page 19).

### ***Oxygen Sensor***

The O<sub>2</sub> sensor is a galvanic type of sensor. A membrane behind the openings on the sensor face allows gas to diffuse into the sensor at a rate proportional to the partial pressure of oxygen. The oxygen reacts in the sensor and produces a voltage proportional to the concentration of oxygen. The voltage is measured by the EAGLE 2's circuitry, converted to a measurement of gas concentration, and displayed on the LCD.

The sensor includes a short cable that terminates in a round 7-position connector. It mates with the **OXY** pins on the main PCB (see "Main PCB" on page 19).

## CO and H<sub>2</sub>S Sensors

The CO and H<sub>2</sub>S sensors are electrochemical sensors that consist of three precious metal electrodes in a dilute acid electrolyte. A gas permeable membrane covers the sensor face and allows gas to diffuse into the electrolyte. The gas reacts in the sensor and produces a current proportional to the concentration of the target gas. The current is amplified by the EAGLE 2's circuitry, converted to a measurement of gas concentration, and displayed on the LCD.

The CO and H<sub>2</sub>S sensors are physically very similar. Except for their markings and wire colors, they look almost identical. A three-position connector at the end of a 2-wire cable from each sensor plugs into a socket on the main PCB. The sockets on the main PCB for the CO and H<sub>2</sub>S sensors are labeled **CO** and **H2S**. Normally, the CO connector plugs into the **CO** socket and the H2S plugs into the **H2S** socket. However, because of the way that the main PCB circuitry is arranged, if the CO sensor is plugged into the H2S socket and the H2S sensor is plugged into the CO socket, the sensors will still operate properly and the CO and H2S readings will still appear on the channels that are programmed for those gases.

## LCD

A digital LCD (liquid crystal display) is visible through a clear plastic window in the top case. The LCD simultaneously shows the gas reading for all installed sensors. The LCD also shows information for each of the EAGLE 2's operating modes.

## Control Buttons

Four control buttons are located below the LCD. They are, from left to right, POWER ENTER RESET, DISPLAY ADJUST NO, AIR ▲ YES, and RANGE ▼ SHIFT.

**Table 3: EAGLE 2 Control Button Functions**

Button	Function(s)
POWER ENTER RESET	<ul style="list-style-type: none"><li>• turns the EAGLE 2 on and off</li><li>• silences and resets audible alarm if Alarm Latching is set to <b>Latching</b> and Alarm Silence is set to <b>ON</b></li><li>• enters instructions, values, and settings into the EAGLE 2's microprocessor</li></ul>
DISPLAY ADJUST NO	<ul style="list-style-type: none"><li>• activates Display Mode</li><li>• silences and resets audible alarm if Alarm Latching is set to <b>Latching</b> and Alarm Silence is set to <b>ON</b></li><li>• enters instructions into the EAGLE 2's microprocessor</li></ul>
AIR ▲ YES	<ul style="list-style-type: none"><li>• activates the demand zero function (adjusts the EAGLE 2's fresh air reading)</li><li>• silences and resets audible alarm if Alarm Latching is set to <b>Latching</b> and Alarm Silence is set to <b>ON</b></li><li>• enters instructions into the EAGLE 2's microprocessor</li><li>• moves the cursor on the LCD up the screen</li><li>• increases the value of a parameter available for adjustment</li><li>• scrolls through parameter options</li></ul>

**Table 3: EAGLE 2 Control Button Functions**

Button	Function(s)
RANGE ▼ SHIFT	<ul style="list-style-type: none"> <li>• changes the detection units of the combustible gas channel (when Catalytic Units is set to <b>CHANGE OK</b> in Setup Mode)</li> <li>• silences and resets audible alarm if Alarm Latching is set to <b>Latching</b> and Alarm Silence is set to <b>ON</b></li> <li>• enters instructions into the EAGLE 2's microprocessor</li> <li>• moves the cursor on the LCD down the screen</li> <li>• decreases the value of a parameter available for adjustment</li> <li>• scrolls through parameter options</li> </ul>

**Printed Circuit Boards (PCBs)**

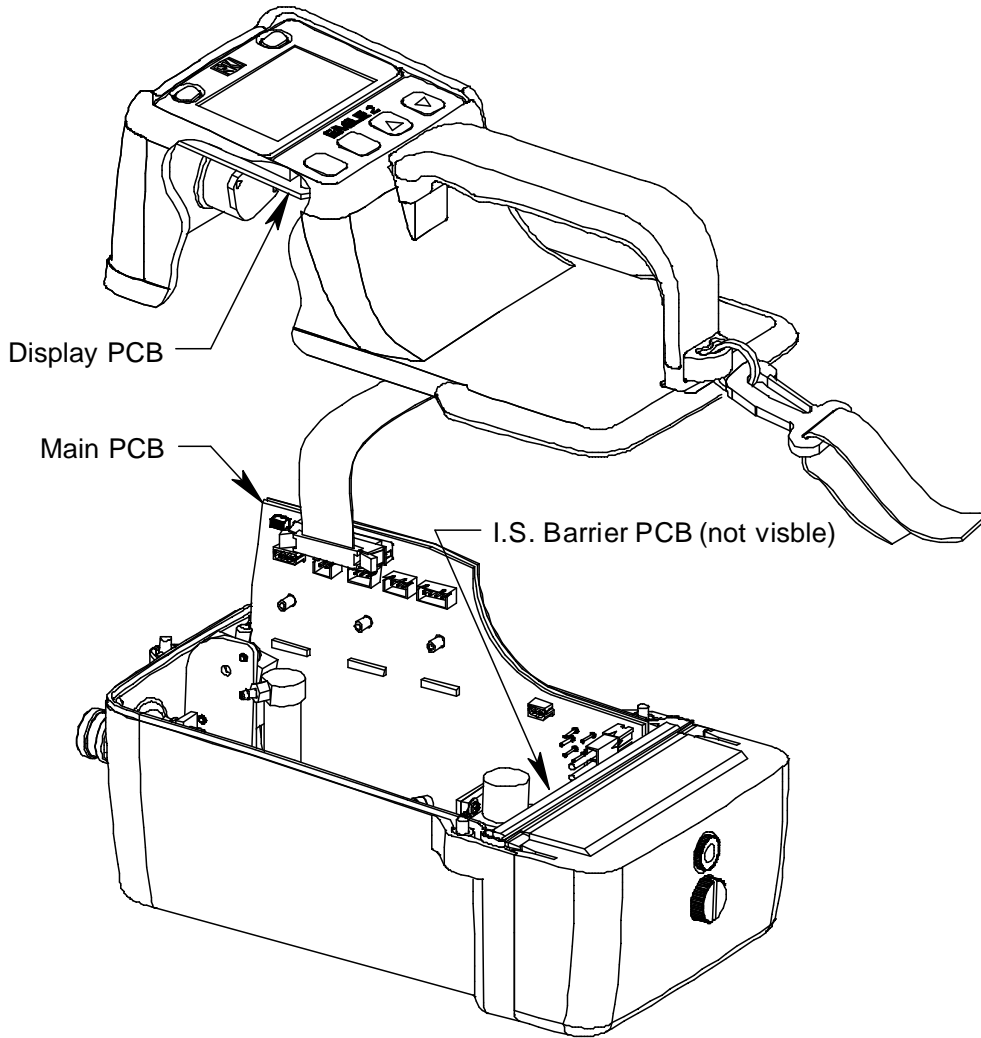

**Figure 4: EAGLE 2 PCBs**

The EAGLE 2's PCBs analyze, record, control, store, and display the information collected. The main PCB and I.S. barrier PCB are located in the bottom case. The display PCB is located in the top case. The display PCB and I.S. barrier PCB are not user serviceable and are not involved in any user performed maintenance. The main PCB is not user serviceable, but it is involved in the replacement of sensors, so it is described below.

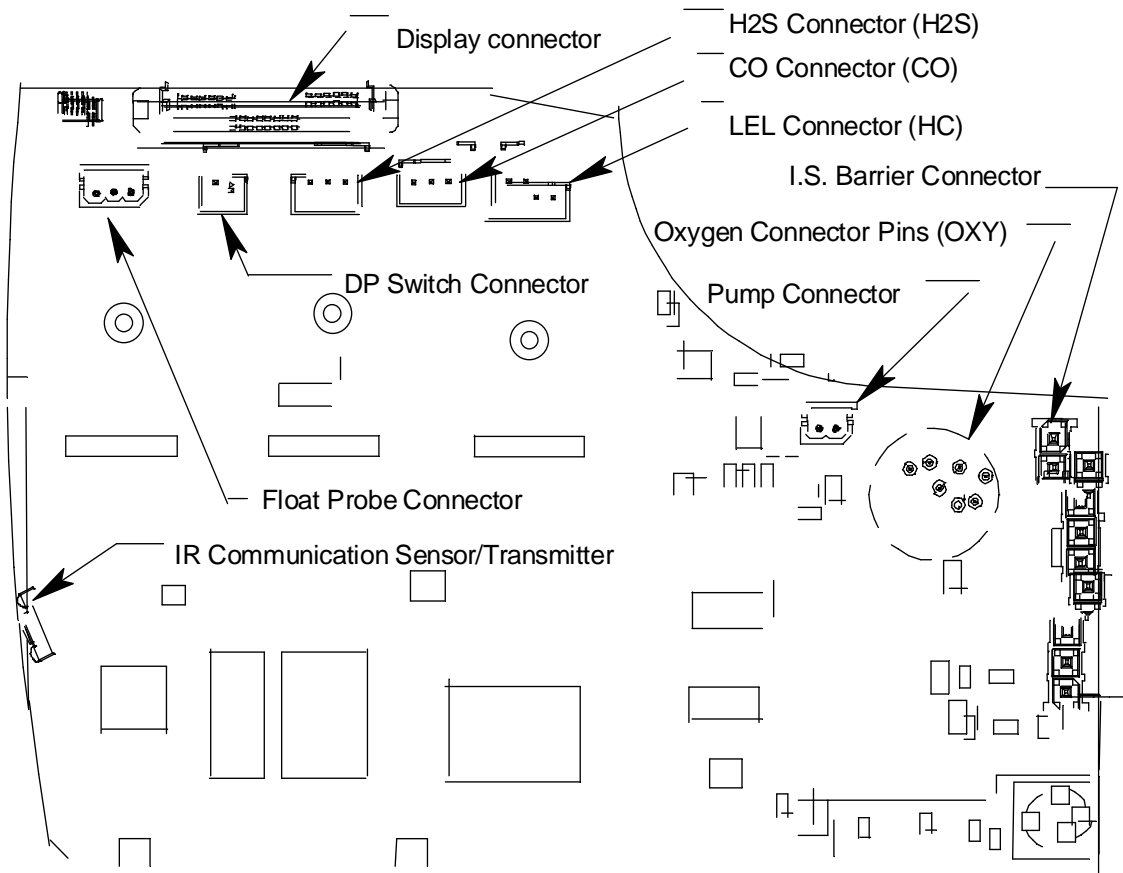

**Figure 5: Main PCB**

The main PCB is located on the right side of the bottom case. It slides into guiding grooves at the bottom, front, and rear of the bottom case. It is held in place by the top case. Connectors for the sensors, differential pressure switch, pump, display PCB, optional float probe, and I.S. barrier PCB are located on the main PCB. In addition, an IR transmitter/receiver is located at the front of the PCB behind the IR port on the front of the bottom case.

### **Alarm LEDs**

Two sets of red alarm LEDs (light emitting diodes) are visible through two raised, frosted plastic lenses in the top case. Each set has two LEDs. They are above the LCD, one above the left corner and one above the right corner. The alarm LEDs alert you to gas, low battery, and failure alarms.

### **Infrared Communications Port**

An infrared (IR) communications port is located on the left front of the bottom case when the instrument is viewed from the front. The data transmitted through the port is in standard IrDA protocol. A computer's infrared port or an IrDA/USB cable connected to a USB port can be used to download data saved by the EAGLE 2 to a computer using the Eagle 2 Data Logger Management Program. See the Data Logger Management Program operator's manual for data logging and downloading instructions.

## Buzzer

A solid-state electronic buzzer is located on the front of the top case. It is a panel mounting type of buzzer and is water resistant and sealed to the inside of the top case with an O-ring. The buzzer sounds for gas alarms, malfunctions, low battery voltage, and as an indicator during use of the EAGLE 2's many display and adjustment options.

## Battery Case & Batteries

Four C-size alkaline batteries (standard) or optional rechargeable C-size Ni-MH batteries power the EAGLE 2. They are installed in the battery case which is located at the rear of the bottom case. The battery case is secured to the bottom case with a thumbscrew.

Instrument run time is dependent upon battery type. At 25°C, alkaline batteries power the EAGLE 2 for 16 hours of non-alarm operation. Ni-MH batteries will power the EAGLE 2 for 18 hours of non-alarm operation. The current battery voltage is viewable in Display Mode (see "Display Mode" on page 41).

When the EAGLE 2 detects low battery voltage, a low battery warning is activated. When battery voltage is too low for operation, the EAGLE 2 sounds a dead battery alarm.

The alkaline or Ni-MH batteries can be accessed for replacement by unscrewing the thumbscrew that secures the battery case to the bottom case and pulling the battery case away from the bottom case. The Ni-MH batteries can be recharged by using the EAGLE 2 charger (see "Replacing or Recharging the Batteries" on page 69).

**NOTE:** Use of batteries or battery chargers not specified by RKI Instruments, Inc. will void the CSA classification and may void the warranty.

**WARNING:** *To prevent ignition of a hazardous atmosphere, batteries must only be changed or charged in an area known to be nonhazardous.*

## Flow System

The EAGLE 2 flow system consists of the inlet fitting, hydrophobic filter, pump, internal tubing, differential pressure (DP) switch, sensor chamber, charcoal filter, and exhaust fitting.

### ***Inlet Fitting***

The inlet fitting is on the right front (when viewed from the front) of the bottom case. It is a nickel plated brass quick connect fitting. It mates with either the sample hose or with the hydrophobic probe.

### ***Hydrophobic Filter***

The hydrophobic filter is located in the bottom case above the sensors. Normally the hydrophobic probe accessory (see "Hose and Probe" on page 21) will prevent water and particulate contamination from entering the flow system, but if the probe is not used, the hydrophobic filter will stop water and particulates from penetrating further into the flow system. If it becomes dirty or water logged, replace it (see "Replacing the Hydrophobic Filter" on page 73).

### ***Pump***

A diaphragm pump inside the rear of the bottom case draws the sample to the sensors. It can draw sample from as far as 125 feet from the EAGLE 2.

**CAUTION:** *Sample hose lengths of more than 125 feet are not recommended for the*

*EAGLE 2 because of flow rate reduction and increased response time.  
Consult RKI Instruments, Inc. for sample hose lengths longer than 125 feet.*

### **Internal Tubing**

The flow system includes polyurethane tubing to route the sample between the various components of the flow system. The internal sample tubing is not user serviceable.

#### **Differential Pressure (DP) Switch**

The DP switch is inside the front of the bottom case. It senses the EAGLE 2's flowrate by monitoring the pressure drop between points in the flow system. When the flowrate becomes too low for safe operation of the EAGLE 2, a set of contacts inside it open and the EAGLE 2 indicates a low flow alarm.

### **Sensor Chamber**

A PVC block in the bottom case is configured to accept the four gas sensors. It routes the sample to each sensor. The LEL sensor and the oxygen sensor are retained in the sensor chamber by brackets. The CO and H<sub>2</sub>S sensors are each pushed past two sealing O-rings into the chamber and are retained by the O-ring compression force.

### **Charcoal Filter**

The charcoal filter is located in the front of the flow chamber next to the CO sensor. It contains activated charcoal. The CO sensor will respond if exposed to H<sub>2</sub>S and certain hydrocarbon gases. The charcoal filter scrubs these gases out of the sample to avoid false CO readings. If false or elevated CO readings are noticed, especially in the presence of H<sub>2</sub>S, change the charcoal filter. The charcoal inside the filter cannot be replaced; the entire filter must be replaced.

### **Exhaust Fitting**

The exhaust fitting is located below the inlet fitting. It routes the gas sample out of the EAGLE 2. It includes a female 10-32 thread that can be used for the installation of a hose barb or other type of fitting that has a male 10-32 thread so that the exhaust can be routed to a particular location with flexible tubing if desired.

---

## **Standard Accessories**

Standard accessories include the shoulder strap, the sample hose, and the hydrophobic probe.

### **Shoulder Strap**

A comfortable elastic shoulder strap clips to the EAGLE 2 at the front and rear of the top case. It clips to stainless steel rings that are installed in features on the top case. It can be removed from the EAGLE 2 by opening the clip at each end of the strap and removing it from the strap ring at the front and rear of the top case.

### **Hose and Probe**

A 5 foot polyurethane sample hose and a 10 inch hydrophobic probe are included as standard. The hose has a male quick connect fitting on one end and a female quick connect fitting on the other end. The probe has a male quick connect fitting. Normally, the male end of sample hose is installed in the EAGLE 2 inlet fitting and the probe is installed in the female end of the hose. However, if the sample hose is not needed for monitoring a particular area, the probe may be installed directly to the inlet fitting. Sample hose lengths

are available from 5 feet (standard length) to 125 feet (see “General Parts List” on page 79). A Teflon lined hose is provided with all units that contain a PID sensor. This hose must be used when operating a PID EAGLE 2 (see “Appendix D: PID Sensors” on page 125).

**CAUTION:** *Sample hose lengths of more than 125 feet are not recommended for the EAGLE 2 because of flow rate reduction and increased response time. Consult RKI Instruments, Inc. for hose lengths longer than 125 feet.*

The probe includes a replaceable particle filter and hydrophobic filter disk that prevent particulates and water from entering the EAGLE 2’s flow system. See “Replacing the Hydrophobic Probe’s Particle Filter and Hydrophobic Filter Disk” on page 72 for instructions to replace the particle filter and hydrophobic filter disk.

**NOTE:** When using the probe with a PID EAGLE 2, be sure that the particle filter is not installed.

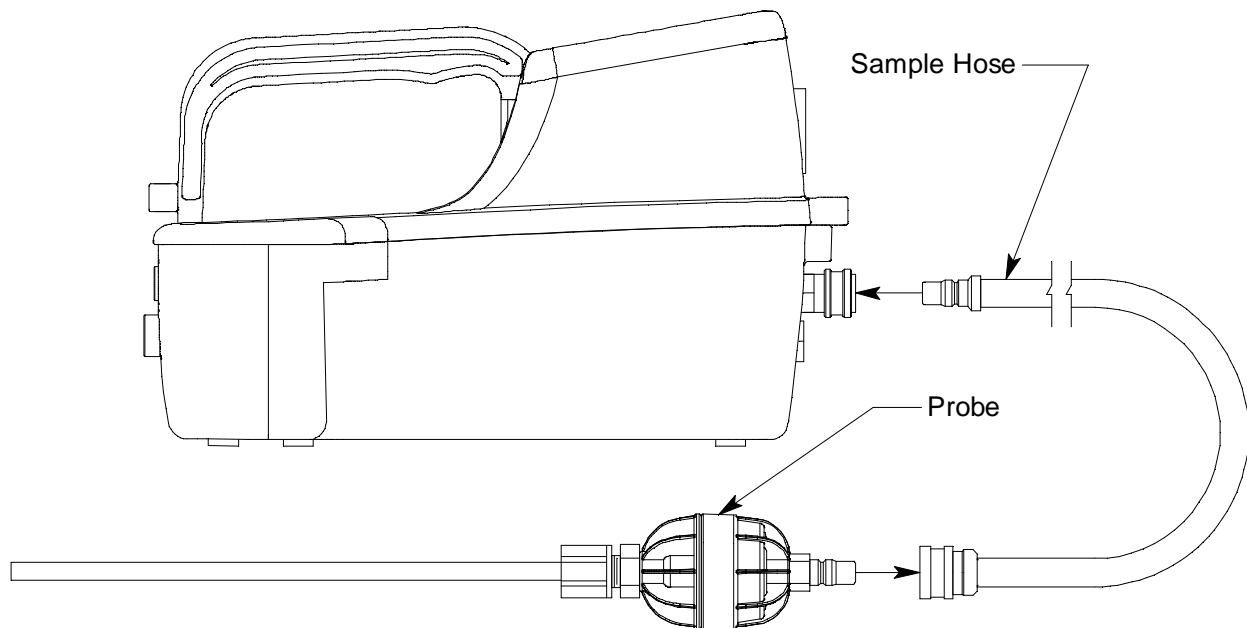

**Figure 6: Sample Hose and Hydrophobic Probe**

## Optional Accessories

Several optional accessories are available for the EAGLE 2. They include rechargeable Ni-MH batteries, battery chargers, various special probes, and dilution fittings. The most commonly used optional accessories are described below. Detailed instructions regarding the use of these and other available accessories are included in other parts of this manual. Data logging accessories are briefly described in “Data Logging” on page 52.

### Rechargeable Ni-MH Batteries

Rechargeable Ni-MH batteries are available for the EAGLE 2. A fully charged set of Ni-MH batteries will power the EAGLE 2 for 18 hours. The batteries will last for a minimum of 500 charge cycles. See “General Parts List” on page 79 for ordering information.

### Battery Chargers

Three battery chargers are available for the EAGLE 2 to charge the optional Ni-MH batteries, the standard AC charger, a DC charger with a vehicle plug adapter, and an AC/DC charger with a vehicle plug adapter.

#### AC Charger

The standard AC charger consists of the charging module, which includes all of the charging circuitry, and an AC adapter. The charging module includes a five foot cable with a connector on the end that mates with the EAGLE 2 charging socket. The AC adapter plugs into a 115 VAC wall outlet and connects to the charging module with a jack on the end of a five foot DC output cable. The AC adapter will also work for 100 VAC or 220 VAC if an appropriate plug adapter is provided. The AC charging station is shown below in Figure 7.



Figure 7: EAGLE 2 AC Charger

## DC Charger

An optional DC powered charger is available with a vehicle plug 12 VDC adapter. It uses the same charging module as the standard AC charger.



Figure 8: EAGLE 2 DC Charger

## AC/DC Charger

A charger is also available that includes both the AC adapter and the 12 VDC vehicle plug adapter. The charging module is the same as the one used for the AC charger and the DC charger.

## Optional Probes

Various optional probes designed for specific applications are available for the EAGLE 2. They include the following:

- 30 inch aluminum probe

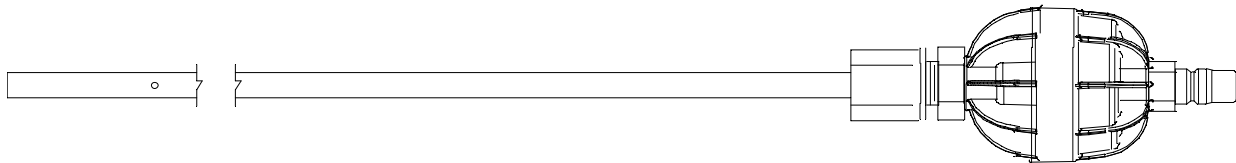

Figure 9: 30 Inch Aluminum Probe

This probe is designed for applications where it is necessary to put the probe tip in areas that are out of reach with the standard probe. A small breather hole near the end of the probe tube prevents interruption of sampling and a low flow alarm if the probe tip is blocked.

- 30 inch stainless steel probe

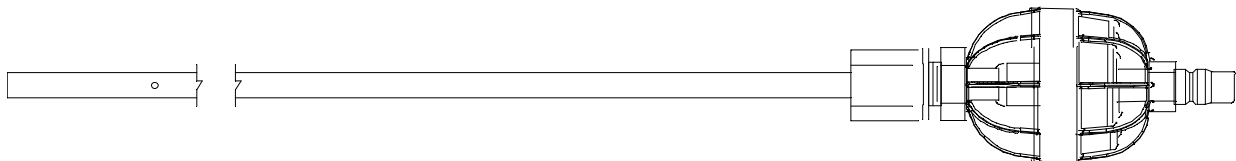
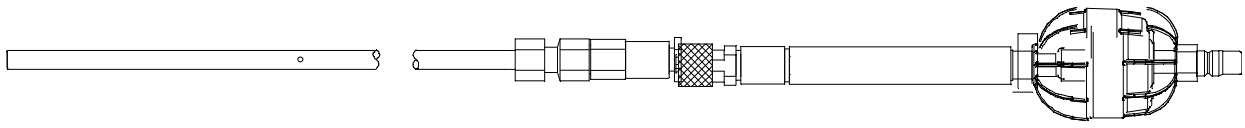

Figure 10: 30 Inch Stainless Steel Probe

This probe is physically the same as the 30 inch aluminum probe and is intended for applications where a high level of corrosion resistance is required in the long probe tube.

- 4 foot stainless steel probe



**Figure 11: 4 Foot Stainless Steel Probe**

This probe is designed for areas where it is necessary to put the probe tip in areas that are out of reach for even the 30 inch probes. A stainless steel probe tube is used because the length of the probe tube requires a high degree of rigidity. Stainless steel is more rigid than other normally used materials. A small breather hole near the end of the probe tube prevents interruption of sampling and a low flow alarm if the probe tip is blocked.

- Barhole probe

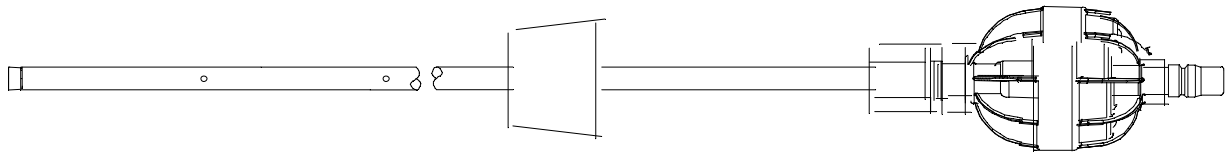

**Figure 12: Barhole Probe**

This probe is designed specifically for barhole testing. See “Appendix K: Using the EAGLE 2 in Bar Hole Mode” for an in-depth discussion of using the EAGLE 2 in Bar Hole Mode.

- 10 inch probe with dust filter

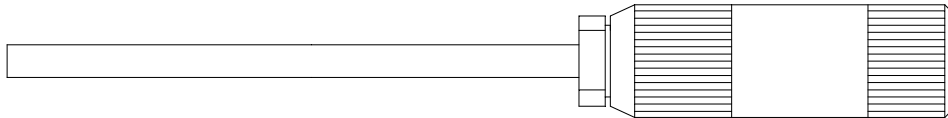

**Figure 13: 10 Inch Probe With Dust Filter**

This probe is designed for use where drawing water or moisture into the EAGLE 2 is not a concern. Instead of a hydrophobic filter, a cotton dust filter is used.

- 32 inch telescoping probe with dust filter

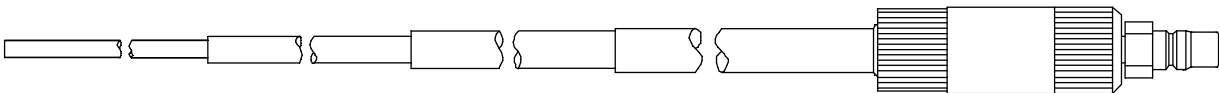

**Figure 14: 32 Inch Telescoping Probe with Dust Filter**

This probe is designed for use where it is necessary to put the probe tip in areas not accessible with the 10 inch probe with dust filter and applications where the probe tube must be collapsible for storage.

- 7 foot telescoping probe with dust filter

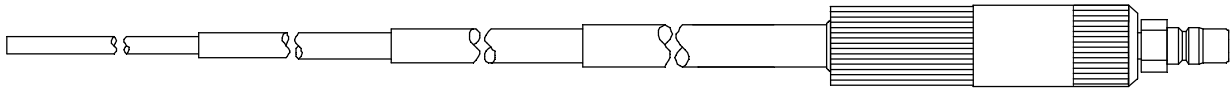

**Figure 15: 7 Foot Telescoping Probe with Dust Filter**

This probe is designed for use where it is necessary to put the probe tip in areas not accessible with the 32 inch telescoping probe with dust filter and applications where the probe tube must be collapsible for storage.

See “General Parts List” on page 79 for probe ordering information.

### External Dilution Fittings

Two external dilution fittings are available for the EAGLE 2, a 1:1 dilution fitting and a 3:1 dilution fitting. They are designed to mate with the inlet fitting and accept a sample hose or probe. The fittings are made with brass and nickel plated brass and are appropriate for use with the four standard gases. The 1:1 fitting is normally used when it is necessary to introduce air into a sample that has no oxygen or a very low level of oxygen, such as a nitrogen purged sample. Both the 1:1 and 3:1 fittings can also be used when one of the target gas levels in the sample area will likely be present in a concentration above the detection range for that gas. Since the fittings partially consist of unplated brass, they are not appropriate for detection of elevated levels of H<sub>2</sub>S or of gases that are easily absorbed such as Cl<sub>2</sub> or SO<sub>2</sub>.

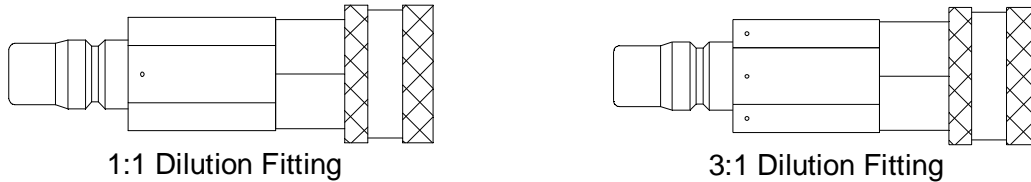

**Figure 16: 1:1 and 3:1 Dilution Fittings**

# Chapter 3: Operation

---

## Overview

This chapter explains how to use the EAGLE 2 to perform confined space entry monitoring or general area monitoring in Normal Mode. There are three operational modes in Normal Mode: Measuring Mode, Display Mode, and Calibration Mode. While in Normal Mode, the unit is normally operating in Measuring Mode. Display Mode and Calibration Mode are accessible from Measuring Mode. Display Mode is described in this chapter. Calibration Mode is described in “Chapter 4: Calibration Mode” on page 54.

Special versions of the EAGLE 2 can also operate in Leak Check Mode and Bar Hole Mode. See “Appendix K: Using the EAGLE 2 in Bar Hole Mode” and “Appendix L: Using the EAGLE 2 in Leak Check Mode” for operating instructions for Bar Hole and Leak Check Mode, respectively.

---

## Start Up

This section explains how to start up the EAGLE 2, get it ready for operation, and turn it off.

**NOTE:** The screens illustrated in this section are for a standard 4-gas unit. The screens displayed by your EAGLE 2 may be slightly different.

### Turning On the EAGLE 2

To illustrate certain functions, the following description of the EAGLE 2 start up sequence assumes that the following menu items in Setup Mode are turned on: LUNCH BREAK, CAL REMINDER, and USER/STATION ID. If any of these items are turned off, then the corresponding screens will not appear.

The EAGLE 2 may be used with a sample hose or with the probe installed directly to the inlet fitting. Determine which configuration works best for your application.

1. Connect the sample hose or probe to the EAGLE 2’s quick connect inlet fitting.
2. If using a sample hose, connect the probe to the sample hose’s quick connect fitting.
3. Press and briefly hold down the POWER ENTER RESET button. Release the button when you hear a beep.
4. The LCD will show the following screen for about ten seconds.



5. The Battery Voltage Screen appears for a few seconds.

BATTERY MIN:  
4.3 VOLTS  
  
BATTERY NOW:  
5.2 VOLTS

6. The Active Gases Screen appears for a few seconds indicating which channels are active and their target gas.

ACTIVE GASES  
  
CH4 OXY  
H2S CO

7. If LUNCH BREAK is turned on (see “Updating the Lunch Break Setting” on page 118), the Resume Measurement Screen appears. The unit counts down from 5 seconds in the lower right corner of the LCD to the right of “MEASUREMENTS”.

LUNCH BREAK MODE ON  
  
RESUME  
PEAK AND TWA  
MEASUREMENTS? 2

- To continue accumulating peak and time-weighted average (TWA) readings from the last time the EAGLE 2 was used, press and release the AIR ▲ YES button before the countdown reaches 0 or allow the countdown to reach 0. If you do not press the AIR ▲ YES button within the 5 second countdown, the EAGLE 2 automatically resumes accumulating the peak and TWA readings. The EAGLE 2 will also continue to keep track of operating time including the operating time from the last time the EAGLE 2 was used. See “Time in Operation Screen” on page 50 for more information about how the EAGLE 2 tracks the operating time. The short-term exposure limit (STEL) reading is reset each time the EAGLE 2 is turned on.
- To reset the accumulation of these measurements, press and release the DISPLAY ADJUST NO button before the countdown reaches 0.

8. The gas alarm setpoints are displayed by three screens in sequence: the Low Alarm Screen, High Alarm Screen, and STEL/TWA Alarm Screen. Each screen remains on the LCD for three seconds.

A	CH4	10 %LEL
L	L OXY	19.5 vol%
O	A H2S	10.0 ppm
W	R CO	25 ppm
M	CH4	10 vol%
S		

A	CH4	50 %LEL
H	L OXY	23.5 vol%
I	A H2S	30.0 ppm
G	R CO	50 ppm
H	M CH4	50 vol%
S		

ALARMS STEL & TWA		
H2S(ppm)	15.0	10.0
CO (ppm)	200	25

9. After the alarm screens, if CAL REMINDER is turned on, the screen that appears next depends on how CAL PAST DUE ACT is set in the Setup Mode Menu (see “Updating the Calibration Past Due Action Setting” on page 113).
- If the unit is due for calibration and CAL PAST DUE ACT is set to CONFIRM TO CAL, then the following screen displays and the buzzer sounds in a double pulsing pattern.

CALIBRATION DATE IS PAST DUE
PERFORM CALIBRATION?

To perform a calibration, press and release the AIR ▲ YES button. The EAGLE 2 will enter Calibration Mode and the LCD will show the Calibration Mode main menu. See “Chapter 4: Calibration Mode” on page 54 for instructions to calibrate the EAGLE 2. When you are done with the calibration and exit Calibration Mode, the unit will begin the startup sequence. If the calibration was successful, the screen above will not appear again until the unit is due for calibration. If the calibration was not successful, the screen above will again appear in the startup sequence.

To continue without performing a calibration, press and release the DISPLAY ADJUST NO button.

- If the unit is due for calibration and CAL PAST DUE ACT is set to MUST CALIBRATE, then the following screen displays and the buzzer sounds in a double pulsing pattern.

CALIBRATION DATE  
IS PAST DUE  
  
ENTER TO PERFORM  
CALIBRATION

The EAGLE 2 cannot be used until a successful calibration has been performed. Press and release the ENTER button to enter Calibration Mode. See “Chapter 4: Calibration Mode” on page 54 for instructions to calibrate the EAGLE 2.

**NOTE:** In this situation, even if the password function has been turned on, no password is required to perform a calibration.

When you are done with the calibration and exit Calibration Mode, the unit will begin the startup sequence. If the calibration was successful, the screen above will not appear again until the unit is due for calibration. If the calibration was not successful, the screen above will again appear in the startup sequence.

- If the unit is due for calibration and CAL PAST DUE ACT is set to NOTIFICATION ONLY, then the following alert screen displays and the buzzer sounds in a double pulsing pattern.

CALIBRATION DATE  
IS PAST DUE

Press and release the POWER ENTER RESET button to acknowledge the alert and continue with the startup sequence.

10. The Date/Time Screen appears for a few seconds.

9/12/2008  
  
15:00:00

11. If USER/STATION ID is turned on (see “Turning the User/Station ID Function On or Off” on page 109), the ID Screen appears for a few seconds.

```
USER ID
MIKE
STATION ID
PUMP 1
SERIAL NUMBER
E2A515
```

If USER/STATION ID is turned off, only the serial number is shown.

12. If the EAGLE 2 experiences a sensor failure during start up, a screen indicating which sensor failed appears and the buzzer sounds a pulsing tone twice per second. In the example below, the H<sub>2</sub>S sensor has failed.

```
FAILED SENSOR(S)

< > < >
<H2S> < >

ENTER TO CONTINUE
```

If you wish to continue, press and release the POWER ENTER RESET button to acknowledge the failure. The gas reading for the failed sensor will be replaced by “XXX”. Replace the failed sensor as soon as possible.

13. The EAGLE 2 is now monitoring for gas in Measuring Mode. The Normal Operation Screen appears displaying the current gas reading for each target gas.

```
CH4    0%LEL
OXY    20.9vol%
H2S    0.0ppm
CO     0ppm
```

## Performing a Demand Zero

Before using the EAGLE 2, it is recommended to set the fresh air readings for the target gases by performing a demand zero. This will set the CH<sub>4</sub>, H<sub>2</sub>S, and CO channels to zero and the OXY channel to 20.9%.

1. Find a fresh-air environment. This is an environment free of toxic or combustible gases and of normal oxygen content (20.9%).
2. Turn on the unit as described above in “Turning On the EAGLE 2”.
3. Press and hold the AIR ▲ YES button. The LCD prompts you to continue holding the AIR ▲ YES button and the buzzer will pulse while you hold the button.
4. Continue to hold the AIR ▲ YES button until the LCD prompts you to release it. The EAGLE 2 will set the fresh air reading for all channels. Start up is complete and the unit is now ready for monitoring.

## Turning Off the EAGLE 2

1. Press and hold the POWER ENTER RESET button.
2. The buzzer will pulse for about five seconds.
3. Release the button when GOODBYE and the RKI logo appear on the display. When GOODBYE and the RKI logo disappear and the backlight turns off, the unit is off.

---

## Using the Battery Charger for Continuous Operation

The battery charger can be used with an AC adapter or a vehicle plug DC adapter to run the EAGLE 2 in continuous operation instead of charging the batteries. Batteries do not need to be installed in the EAGLE 2 but if there are batteries installed, they must be NiMH batteries and they must have a charge.

**WARNING:** *Use the EAGLE 2 charger's continuous operation mode to power the EAGLE 2 only if NiMH batteries are installed in the EAGLE 2 or if no batteries are installed in the EAGLE 2. Do not use the charger for continuous operation if alkaline batteries are installed.*

1. Place the EAGLE 2 in the area to be monitored.
2. Plug the power adapter into either an AC outlet or into a vehicle outlet depending on which charger is being used.
3. Set the switch on the module to "CONT. OPERAT.".
4. Make sure the EAGLE 2 is off.
5. Make sure the adapter and module are connected.
6. Make sure that the NiMH batteries are either charged or removed.

**NOTE:** If the batteries are not charged, the EAGLE 2 will not turn on and will instead give a "Charge Batteries" indication when it is powered up after Step 7 below.

7. Insert the module's round plug into the EAGLE 2's charging jack as shown in Figure 17 below.



Figure 17: Connecting the EAGLE 2 to the Charger

8. See “Chapter 3: Operation” on page 27 for instructions for start-up and operation of the EAGLE 2.
9. While the charging module is powering the EAGLE 2, its amber LED will be off and its green LED will be on.

---

## Measuring Mode, Normal Operation

When the EAGLE 2 completes its startup sequence, it is in Measuring Mode. In Measuring Mode the EAGLE 2 continuously monitors the sampled atmosphere and displays the gas concentrations present for its target gases. In a low-light environment, press and release any button to turn on the display backlight. See “Updating the Backlight Delay Setting” on page 110 to program backlight duration. If the Confirmation Alert feature is turned on in the Setup Mode menu (see “Updating the Confirmation Alert Setting” on page 115), the EAGLE 2 beeps periodically to confirm that it’s operating.

### Monitoring an Area

1. Start up the EAGLE 2 as described above in “Start Up” on page 27. It is now in Measuring Mode.

CH4	0%LEL
OXY	20.9vol%
H2S	0.0ppm
CO	0ppm

2. Take the EAGLE 2 to the monitoring area.  
Put the probe tip in the area to be monitored.

**NOTE:** If the particle filter or hydrophobic filter become dirty or clogged, replace them. If water enters the probe, dry out or replace the particle filter (if installed) and shake any water out of the probe or off of the hydrophobic filter. If you notice that water has entered the flow system through the probe, replace the probe’s hydrophobic filter and inspect the O-ring for filter particles. See “Replacing the Hydrophobic Probe’s Particle Filter and Hydrophobic Filter Disk” on page 72 for instructions to replace the particle filter and the hydrophobic filter.

3. Wait 10 - 15 seconds and observe the display for gas readings. If a reading is observed, allow the reading to stabilize to determine the gas concentrations present.

**NOTE:** Response time increases with the length of the sample hose. Long sample hoses will require more time to show a response at the EAGLE 2. The maximum sample hose length recommended for the EAGLE 2 is 125 feet. Consult RKI Instruments, Inc. for longer sample hose lengths.

4. If a gas alarm occurs, take appropriate action. See “Responding to Alarms” on page 40.

## Using Optional Sample Hoses

The standard sample hose for the EAGLE 2 is 5 feet long. Optional hoses are available up to 125 feet long. If you are considering using a longer hose, keep in mind that a longer hose will increase the EAGLE 2's response time and the flowrate may decrease close to the low flow alarm point.

**CAUTION:** *Sample hose lengths of more than 125 feet are not recommended for the EAGLE 2 because of flow rate reduction and increased response time. Consult RKI Instruments, Inc. for hose lengths longer than 125 feet.*

The chart below illustrates how response time is affected by the sample hose length.

**Table 4: EAGLE 2 Response Time vs. Sample Hose Length**

Hose Used	Typical Time to 90% of Response (T90)
Probe Only	12 seconds
Probe & 5 Foot Hose	15 seconds
Probe & 25 Foot Hose	25 seconds
Probe & 50 Foot Hose	35 seconds
Probe & 75 Foot Hose	45 seconds
Probe & 100 Foot Hose	60 seconds
Probe & 125 Foot Hose	75 seconds

## Using Exhaust Tubing

The EAGLE 2's exhaust fitting has a female 10-32 thread to allow for the installation of a hose barb fitting with a 10-32 thread to which a flexible exhaust tube can be connected. If you utilize this feature, the tubing used must have a minimum internal diameter of 1/8 inch. RKI Instruments, Inc. recommends using flexible polyurethane tubing with a maximum exhaust tube length of 20 feet. Consult RKI Instruments, Inc. for exhaust tubing lengths longer than 20 feet.

## Combustible Gas Detection

There are three issues to keep in mind when monitoring for combustible gas.

- The catalytic combustible sensor will respond to any combustible gas. The standard calibration gas for the EAGLE 2 catalytic combustible channel is methane (CH<sub>4</sub>). If the instrument is calibrated to a different combustible gas, such as hexane or propane, the gas name for the catalytic combustible channel will reflect the target gas.

The table below lists the conversion factors for several hydrocarbon gases **if the EAGLE 2 is calibrated to methane**. To use this table, multiply the display reading on the combustible gas channel by the factor in the appropriate row to obtain the actual gas concentration. For example, if you are detecting pentane and the display reads 10% LEL for the catalytic combustible channel, you actually have 10% LEL x 1.95 = 19.5% LEL pentane present.

**Table 5: Full Response Mode Conversion Factors (Methane Calibration)**

Target Gas	LEL Factor	PPM Factor	Target Gas	LEL Factor	PPM Factor
Acetone	1.40	0.70	Isobutane	1.61	0.58
Benzene	1.75	0.42	Isopropanol	2.22	0.89
Butyl Acrylate	3.95	1.34	Methane	1.00	1.00
Butyl Acetate	3.38	0.88	Methanol	1.23	1.48
2-Butyl Alcohol	1.94	0.66	Methyl Acetate	1.37	0.85
1-Butyl Alcohol	2.65	0.74	Methyl Acrylate	1.10	0.62
Cyclohexane	1.82	0.47	Methyl Ethyl Ketone	2.53	0.71
Cumene	3.90	0.70	Methyl Isobutyl Ketone	2.53	0.61
Ethylene Dichloride	2.75	3.41	Mixed Xylenes	2.36	0.52
Ethyl Alcohol	1.38	0.91	Nonane	2.87	0.46
Ethyl Chloride	1.26	0.96	Pentane	1.95	0.59
Ethyl Acrylate	2.45	0.69	Propane	1.50	0.63
Hexane	2.44	0.54	Styrene	2.94	0.53
Hydrogen	1.16	0.93	Toluene	2.16	0.48
			Vinyl Acetate Monomer	1.48	0.77
* Vapor pressure too low for significant LEL reading					

- The EAGLE 2 provides the catalytic combustible sensor with some protection against exposure to high levels of combustible gas which can damage the sensor. It does this by turning off the combustible sensor power temporarily when it determines that an over scale (more than 100% LEL) concentration of combustible gas is present that may damage the sensor. Nevertheless, concentrations of combustible gas of more than 100% LEL can still affect the zero level or calibration of the combustible sensor if the concentration is high enough.

**CAUTION:** Do not expose the catalytic combustible sensor to high concentrations of combustible gas such as that from a butane lighter. Exposure to high concentrations of combustible gas may adversely affect the performance of the sensor.

**CAUTION:** Any rapid increase in the combustible gas reading on the catalytic combustible channel followed by a declining or erratic reading may indicate a gas concentration above the LEL which may be hazardous.

- Some gases such as silicone vapors, chlorinated hydrocarbons, and sulphur compounds can contaminate the detection elements inside the combustible sensor damaging the sensor and result in reduced response to combustible gas. Make every effort to avoid these gases. The catalytic combustible sensor has an integral H<sub>2</sub>S scrubber for protection from H<sub>2</sub>S exposure resulting from normal use, but you should avoid exposure to high levels of H<sub>2</sub>S and other sulphur compounds.

### Monitoring Combustible Gas in the PPM or %Volume Range

The standard factory configuration for the EAGLE 2 allows the user to use the RANGE ▼ SHIFT button to change the displayed detection units of the catalytic combustible channel between %LEL, ppm, and %volume. It is possible to disable this capability and set the EAGLE 2 to display only one of the detection units by using the Catalytic Units menu item in Setup Mode. See “Setting the Catalytic Detection Units” on page 105 for instructions to set this Setup Mode Menu item.

The detection range of the combustible catalytic channel when set for ppm or %volume will correspond to 0 - 100% LEL for the configured gas. For example, the LEL for methane (CH<sub>4</sub>) is 5% volume, or 50,000 ppm. So if the catalytic combustible channel is displayed in terms of %volume, the full scale is 5.00% and if it is displayed in terms of ppm, the full scale is 50,000 ppm.

If the Catalytic Units menu item in Setup Mode is set to **CHANGE OK**, the standard factory setting, then you can change the catalytic combustible channel’s units by pressing and releasing RANGE ▼ SHIFT.

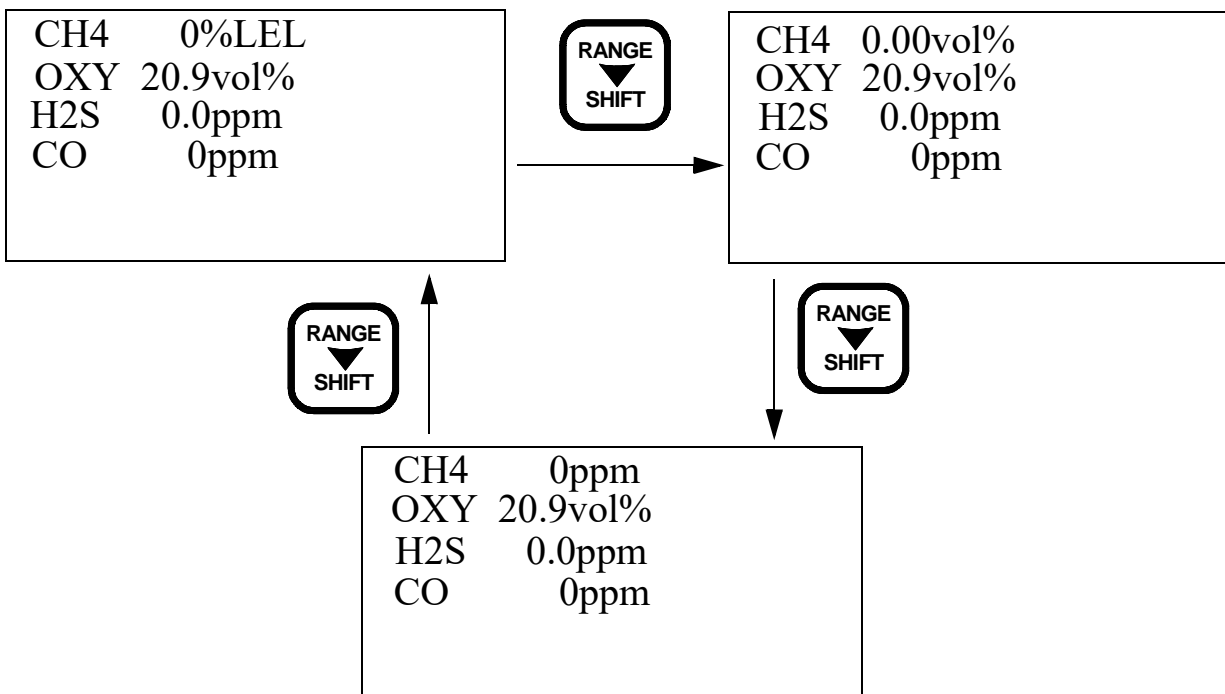

## Monitoring Combustible Gas in the PPM Range

There are special considerations that must be taken into account when monitoring combustible gas in the ppm range with the catalytic combustible channel. Because of the high sensitivity in the lower part of the ppm range, the catalytic combustible channel needs more time than the warm-up period to stabilize after the EAGLE 2 is turned on if it is going to be used for ppm level detection. The reading increments in the ppm range are smallest in the lower part of the range and increase as the reading increases as follows:

- 5 ppm increments from 0 ppm to 200 ppm
- 10 ppm increments from 200 ppm to 1,000 ppm
- 50 ppm increments from 1,000 ppm to 10,000 ppm
- 250 ppm increments from 10,000 ppm to 50,000 ppm

If the catalytic combustible channel is configured for the user defined gas in Setup Mode (see “Configuring the Combustible Gas” on page 101), the ppm ratio defined for the gas must be considered. For example, if the ppm ratio is set higher than 50,000 ppm, then when the display units are set as ppm, the reading will not go above 50,000 ppm which is equivalent to 33 % LEL and 5 %volume. So if the gas reading is higher than 50,000 ppm, the ppm unit reading will indicate 50,000 ppm and also indicate an overscale condition. The %LEL and %volume unit readings will still increase up to 100% LEL and 15 %volume respectively, which are equivalent to 150,000 ppm.

The catalytic combustible sensor is slightly affected by humidity. This is not apparent when the EAGLE 2 is used for %LEL or %volume detection, but because of the high sensitivity in the ppm range, significant humidity changes can affect the ppm reading, especially in the lower part of the range. Take care to allow the unit to acclimate to a new environment for about a minute and perform a demand zero in a fresh air location when you move between areas of different humidity.

**CAUTION:** *If the catalytic combustible channel is being calibrated with a gas concentration of 1000 ppm or lower, the a 24 inch humidifier must be used for accurate calibration. See “Chapter 4: Calibration Mode” on page 54 for more explanation and instructions for calibration.*

To monitor for combustible gas in the ppm range:

1. Start up the EAGLE 2 as described in “Start Up” on page 27.
2. Allow the EAGLE 2 to run for 3 - 5 minutes after the startup sequence is complete and it is in Measuring Mode. This allows the catalytic combustible sensor to stabilize sufficiently for ppm monitoring.

**NOTE:** This extra stabilization period is not necessary if monitoring in the %LEL or %volume range.

3. Set the catalytic combustible channel’s units to be ppm by using the RANGE ▼ SHIFT button.
4. Perform a demand zero as described in “Performing a Demand Zero” on page 31.
5. Proceed to monitor for gas as described in “Monitoring an Area” on page 33.

## Measuring Mode, Alarms

This section covers alarm indications in Measuring Mode. It also describes how to reset the EAGLE 2 after an alarm has occurred and how to respond to an alarm condition.

**NOTE:** False alarms may be caused by radio frequency (RF) or electromagnetic (EMI) interference. Keep the EAGLE 2 away from RF and EMI sources such as radio transmitters or large motors.

### Alarm Indications

The EAGLE 2 will sound an alarm and flash the LED arrays when one of the target gas concentrations rises above the Low Alarm level, or in the case of oxygen falls below the Low Alarm level, for that gas.

The EAGLE 2 also sounds an alarm and flashes the LED arrays when one of the target gas concentrations rises above the High Alarm level and when the STEL and TWA alarm levels are reached for CO and H<sub>2</sub>S.

**NOTE:** If an alarm condition occurs while you are in Display Mode, the EAGLE 2 will automatically bring up the alarm screen instead.

When a failure condition occurs, such as a sensor failure, low flow, or dead battery condition, the unit will also sound an alarm and flash the LED arrays.

The table below summarizes the types of alarms produced by the EAGLE 2 and their indications.

**Table 6: Alarm Types and Indications**

Alarm Type	Visual Indications	Audible Indication
<b>Low Alarm</b> Concentration of gas rises above the Low Alarm setting or falls below the Low Alarm setting for O <sub>2</sub> .	<ul style="list-style-type: none"><li>• <b>ALRM1</b> appears next to gas reading</li><li>• Alarm LED arrays flash once per second</li><li>• Backlight turns on</li></ul>	Pulsing tone once per second
<b>High Alarm</b> Concentration of gas rises above the High Alarm setting.	<ul style="list-style-type: none"><li>• <b>ALRM2</b> appears next to gas reading</li><li>• Alarm LED arrays flash twice per second</li><li>• Backlight turns on</li></ul>	Pulsing tone twice per second
<b>TWA or STEL</b> Concentration of CO or H <sub>2</sub> S rises above the TWA or STEL alarm setting.	<ul style="list-style-type: none"><li>• Alarm LED arrays flash once per second</li><li>• Backlight turns on</li><li>• <b>TWA</b> or <b>STEL</b> appears next to gas reading</li></ul>	Pulsing tone once per second

**Table 6: Alarm Types and Indications**

Alarm Type	Visual Indications	Audible Indication
<b>Over Range</b>	<ul style="list-style-type: none"> <li>• <b>OVER</b> appears next to gas reading</li> <li>• Gas reading indicates full scale</li> <li>• Alarm LED arrays flash twice per second</li> <li>• Backlight turns on</li> </ul>	Pulsing tone twice per second
<b>Low Flow</b>	<ul style="list-style-type: none"> <li>• The display indicates <b>FAIL LOW FLOW LEVEL</b></li> <li>• Alarm LED arrays flash in a double pulsing pattern once per second</li> <li>• Backlight turns on</li> </ul>	Double pulsing tone once per second
<b>Low Battery Warning</b>	<ul style="list-style-type: none"> <li>• <b>BATT</b> appears vertically along the left side of LCD</li> </ul>	None
<b>Dead Battery Alarm</b>	<ul style="list-style-type: none"> <li>• Gas readings replaced by <b>RECHARGE INSTRUMENT BATTERIES</b></li> <li>• Alarm LED arrays flash in a double pulsing pattern once per second</li> </ul>	Double pulsing tone once per second
<b>Sensor Failure</b>	<ul style="list-style-type: none"> <li>• <b>FAILED SENSOR(S)</b> appears at the top of the display and the failed sensor(s) are indicated</li> <li>• Alarm LED arrays flash in a double pulsing pattern once per second</li> </ul>	Double pulsing tone once per second

## Resetting and Silencing Alarms

You can set the EAGLE 2's gas alarms as latching or self-resetting alarms (see "Updating the Alarm Latching Setting" on page 108).

- Self-resetting alarms (ALARM LATCHING set to SELF RESET)

Self-resetting alarms automatically shut off and reset when the gas reading falls below (or rises above for an oxygen low alarm) the alarm setting. You cannot reset self-resetting alarms with the POWER ENTER RESET button. You can set self-resetting alarms with or without the alarm silence feature (see "Updating the Alarm Silence Setting" on page 108).

- Latching alarms (ALARM LATCHING set to LATCHING)

Latching alarms will remain in effect until the gas reading falls below (or rises above for an oxygen low alarm) the alarm setting and they are reset with the POWER ENTER RESET button. You can set latching alarms with or without the alarm silence feature (see "Updating the Alarm Silence Setting" on page 108).

### **ALARM SILENCE On and Alarms Set to LATCHING:**

ALARM SILENCE set to ON and ALARM LATCHING set to LATCHING are the factory settings. When the EAGLE 2 goes into gas alarm, press and release any button to silence the buzzer. If the gas concentration was still above the alarm level when the button was pressed, the LED arrays continue to flash, and the EAGLE 2 continues to display the current alarm level.

The gas reading must fall below (or rise above for an oxygen low alarm) an alarm setting before you can reset the alarm. When the alarm condition passes, press and release the POWER ENTER RESET button to reset the alarm. The LED arrays turn off and the EAGLE 2 alarm indications on the display turn off.

### **ALARM SILENCE Off and Alarms Set to LATCHING:**

The gas reading must fall below (or rise above for an oxygen low alarm) an alarm setting before you can reset the alarm. When the alarm condition passes, press and release the POWER ENTER RESET button to reset the alarm. The LED arrays and buzzer turn off and the EAGLE 2 alarm indications on the display turn off.

### **ALARM SILENCE On and Alarms Set to SELF RESETTING:**

When the EAGLE 2 goes into gas alarm, press and release any button to silence the buzzer. The POWER ENTER RESET button will not reset the alarm. When the gas reading falls below (or rises above for an oxygen low alarm) an alarm setpoint, the alarm will automatically reset. The LED arrays turn off and the EAGLE 2 alarm indications on the display turn off.

### **With ALARM SILENCE Off and Alarms Set to SELF RESETTING:**

When the EAGLE 2 goes into gas alarm, the POWER ENTER RESET button will not silence or reset the alarm. When the gas reading falls below (or rises above for an oxygen low alarm) an alarm setpoint, the alarm will automatically reset. The LED arrays and buzzer turn off and the EAGLE 2 alarm indications on the display turn off.

## **Responding to Alarms**

This section describes response to gas, over range, battery, and sensor failure alarms.

### **Responding to Gas Alarms**

1. Determine which gas alarm has been activated.
2. Follow your established procedure for an increasing gas condition or a decreasing oxygen condition.
3. If necessary, reset the alarm using the POWER ENTER RESET button once the alarm condition has passed.

### **Responding to Over Range Alarms**

**WARNING:** *An over range condition may indicate an extreme combustible gas, toxic gas, or oxygen concentration. Confirm a normal condition with a different EAGLE 2 or with another gas detecting device.*

1. Determine which channel is in alarm.
2. Follow your established procedure for an extreme gas condition.
3. Reset the alarm using the POWER ENTER RESET button once the alarm condition has cleared.
4. Calibrate the EAGLE 2 as described in “Chapter 4: Calibration Mode” on page 54.

5. If the over range condition continues or if you are not able to successfully calibrate the unit, you may need to replace the sensor that has triggered the over range alarm.
6. If the over range condition continues after you have replaced the sensor, contact RKI Instruments, Inc. for further instructions.

### **Responding to Battery Alarms**

**WARNING:** *The EAGLE 2 is not operational as a gas monitoring device during a dead battery alarm. Take the Model EAGLE 2 to a non-hazardous area and replace or recharge the batteries as described in “Replacing or Recharging the Batteries” on page 69.*

The EAGLE 2 is fully functional during a low battery warning. However, only a limited amount of operating time remains, approximately 1 - 2 hours. The amount of time depends on how often the LCD backlight is used and how often the unit is responding to alarm conditions. Recharge the Ni-MH batteries or replace the alkaline batteries as soon as possible as described in “Replacing or Recharging the Batteries” on page 69.

**NOTE:** Alarms and the LCD back light consume battery power and reduce the amount of operating time remaining.

### **Responding to Sensor Failure Alarms**

1. Determine which sensor has triggered the sensor failure alarm.
2. Try calibrating the sensor first, as described in “Chapter 4: Calibration Mode” on page 54 before replacing it.
3. If the sensor failure continues, replace the sensor as described in “Replacing a Sensor” on page 76.
4. If the sensor failure condition continues after you have replaced the sensor, contact RKI Instruments, Inc. for further instructions.

---

## **Display Mode**

Two other operating modes are accessible when the EAGLE 2 is in Measuring Mode. They are Display Mode and Calibration Mode. This section describes using the EAGLE 2 in Display Mode. In Display Mode you can:

- display peak readings
- display the minimum operating and current battery voltage
- select how the active channels are displayed on the LCD
- turn the catalytic LEL sensor on or off (if there is a TC or infrared combustible channel along with a catalytic combustible channel)
- enable or disable methane elimination mode (if the catalytic combustible gas channel is configured appropriately in the **CONFIGURE GASES** item in Setup Mode)
- temporarily configure the catalytic combustible channel for a target gas other than the one used for calibration (if the **RELATIVE RESPONSE** item in Setup Mode is set to **ON**)
- display STEL readings (*H<sub>2</sub>S and CO only*)
- display TWA readings (*H<sub>2</sub>S and CO only*)

- display alarm settings
- select the user ID (if the **USER/STATION ID** item in Setup Mode is set to **ON**)
- select the station ID (if the **USER/STATION ID** item in Setup Mode is set to **ON**)
- display time in operation
- display date and time
- display remaining data logging time and clear data logger memory (if the **DATA LOG MEMORY** item in Setup Mode is set to **ON**)

### Tips for Using Display Mode

- To enter Display Mode and scroll from one screen to the next or skip an item when a question is asked, press and release the DISPLAY ADJUST NO button.
- To enter an item when a question is asked, press and release the AIR ▲ YES button.
- To change a flashing parameter, use either the AIR ▲ YES button or RANGE ▼ SHIFT button.

**NOTE:** Each screen displays for 20 seconds. If you do not press a button within 20 seconds, the EAGLE 2 automatically returns to Measuring Mode.

### Peak Screen

The peak screen displays the highest (lowest for oxygen) concentrations detected since the EAGLE 2 was turned on. Peak readings are stored in the EAGLE 2's memory until a higher level is detected (lower for oxygen), the peak reading is cleared, or the EAGLE 2 is turned off.

The lunch break feature enables the EAGLE 2 to save peak readings when it is turned off so it can continue them when it is turned on again. See "Turning On the EAGLE 2" on page 27

CH4	0%LEL
P OXY	20.9vol%
E H2S	0.0ppm
A CO	0ppm
K	

To clear the peak readings, do the following:

1. With the Peak Screen displayed, press and release the POWER ENTER RESET button. The following screen will appear.

<p>CLEAR</p> <p>PEAK READINGS?</p>
------------------------------------

2. Press and release the AIR ▲ YES button. The peak readings will be reset and the unit will return to the Peak Screen.

If you do not want to clear the peak readings, press and release the DISPLAY ADJUST NO button and the unit will return to the Peak Screen without clearing the peak readings.

## Battery Voltage Screen

The Battery Voltage Screen displays the minimum operating voltage and the current battery voltage. Fully charged alkaline batteries typically indicate 6.0 volts; fully charged Ni-MH batteries typically indicate 5.2 volts. This screen also displays during the startup sequence.

BATTERY MIN:  
4.3 VOLTS  
  
BATTERY NOW:  
5.2 VOLTS

## Gas Display Screen

The Gas Display Screen gives you the option to select how the active channels are displayed.

SELECT  
  
GASES DISPLAYED

You can display all of them on the screen at the same time, one at a time with automatic scrolling, or one at a time with manual scrolling. The factory setting displays all of the active channels at the same time. To select how to display the active channels, do the following:

1. With the Gas Display Screen displayed, press and release the AIR ▲ YES button. The following screen will appear with the cursor blinking.

SELECT  
> DISPLAY ALL  
SCROLL AUTO  
SCROLL MANUAL

2. Use the AIR ▲ YES and RANGE ▼ SHIFT buttons to place the cursor next to the desired choice.
3. Press and release the POWER ENTER RESET button. The unit continues to the STEL Screen and the display configuration will reflect your choice when you return to Measuring Mode.

If you do not want to change the setting, press and release the DISPLAY ADJUST NO button and the unit will return to the Gas Display Screen.

## Catalytic (LEL) Sensor Screen

This screen appears only when either a TC sensor or an infrared combustible sensor is installed in an EAGLE 2 along with a catalytic combustible LEL sensor. See “Appendix F: TC Sensors”, “Appendix H: Infrared Methane Sensor”, or “Appendix I: Infrared Hydrocarbon Sensor” for a description of this screen and instructions to use it.

## Methane Elimination Mode Screen

This screen displays only if the EAGLE 2 catalytic combustible channel is setup for one of the gases in the CONFIGURE GASES menu item in Setup Mode that supports methane elimination (See “Configuring the Combustible Gas” on page 101).

METHANE ELIMINATION  
MODE  
  
DISABLED

The standard setup for methane (CH<sub>4</sub>) does not support methane elimination. When applicable, use this screen to enable and disable the methane elimination feature. See “Appendix J: Methane Elimination Mode” for more discussion of the methane elimination feature.

1. With the Methane Elimination Mode Screen displayed, press and release the AIR ▲ YES or RANGE ▼ SHIFT button to toggle to the desired setting, ENABLED or DISABLED.
2. Press and release the POWER ENTER RESET button. The unit will save the setting and proceed to the next menu item.

If you changed the setting and do not want to save the change, press and release the DISPLAY ADJUST NO button to continue to the next menu item without saving the change.

## Catalytic Sensor Relative Response Screen

This screen displays only if **RELATIVE RESPONSE** in Setup Mode is set to ON (see “Updating the Catalytic Sensor Relative Response Setting” on page 106). Use this screen to temporarily change the gas configuration of the catalytic combustible channel.

SELECT  
RELATIVE RESPONSE  
TO CALIBRATED GAS  
FOR CATALYTIC SENSOR

You can select from a list of gases whose response relative to the configured gas, normally methane, is programmed into the EAGLE 2’s memory. This includes several pre-defined gases and 5 gases that can be entered into the EAGLE 2 in the field using the Eagle 2 Maintenance Data Loader Program. In order to program a field defined gas into the

EAGLE 2, gas testing must be performed to determine the gas' response factor relative to methane. See the Eagle 2 Maintenance Data Loader Program Operator's manual for details regarding the gas testing and programming user defined gases into the EAGLE 2's relative response list. The last five items in the gas list are reserved for field defined gases.

The relative response feature enables you to temporarily monitor for the selected gas without having to recalibrate the EAGLE 2. The EAGLE 2 will clear the gas configuration change when it is turned off and will return to the programmed configuration when it is turned on again.

Because of normal variation between sensors, these relative response factors are typical factors. If you use this feature, the response to the selected gas will not be as accurate as it would be if you configured and calibrated the catalytic combustible channel to the target gas.

**NOTE:** For maximum accuracy, configure and calibrate the EAGLE 2's catalytic combustible channel to the desired target gas.

1. With the Relative Response Screen displayed, press and release AIR ▲ YES. A list of gases will appear on the screen with **EXIT** at the top of the list. There are multiple screens of gases.

```

>EXIT
ACETONE
BENZENE
BUTYL ACRYLATE
BUTYL ACETATE
2-BUTYL ALCOHOL
    
```

The following is the complete list of factory defined gases.

**Table 7: Relative Response Gas List**

Acetone	Cumene	Isobutane	Methyl lbutyl Ketone	Mixed Xylenes
Benzene	Ethylene Dichloride	Isopropanol	Nonane	Field Defined Gas
Butyl Acrylate	Ethyl Alcohol	Methane	Pentane	Field Defined Gas
Butyl Acetate	Ethyl Chloride	Methanol	Propane	Field Defined Gas
2-Butyl Alcohol	Ethyl Acrylate	Methyl Acetate	Styrene	Field Defined Gas
1-Butyl Alcohol	Hexane	Methyl Acrylate	Toluene	Field Defined Gas
Cyclohexane	Hydrogen	Methyl Ketone	Vinyl Acetate	

2. Use the AIR ▲ YES or RANGE ▼ SHIFT buttons to move the cursor next to the desired gas.
3. Press and release POWER ENTER RESET. The catalytic combustible channel will be configured to the selected gas and the EAGLE 2 will proceed to the STEL Screen. This configuration will be in force until either a different gas is selected in Display Mode or the unit is turned off.

**NOTE:** If a PID sensor is installed in the EAGLE 2 and **CATALYTIC SENSOR RELATIVE RESPONSE** is set to ON in Setup Mode, a PID Sensor Relative Response Screen appears after the Catalytic Sensor Relative Response Screen. If **CATALYTIC SENSOR RELATIVE RESPONSE** is set to OFF, the PID Sensor Relative Response Screen will still appear after the Methane Elimination Mode Screen. See “PID Relative Response Feature” on page 128 for a description of the relative response feature for the PID sensor.

**NOTE:** If Methane Elimination Mode is enabled, the Catalytic Sensor Relative Response screen does not appear.

### STEL Screen

The STEL Screen displays the short term exposure limit (STEL) readings *for H<sub>2</sub>S and CO only*. The STEL reading is the average reading *over the last 15 minutes*.

S	H <sub>2</sub> S	0.0ppm
T	CO	0ppm
E		
L		

### TWA Screen

The TWA Screen displays the time weighted average (TWA) readings *for H<sub>2</sub>S and CO only*.

T	H <sub>2</sub> S	0.0ppm
W	CO	0ppm
A		

The TWA reading is the average reading *over the last 8 hours*. If 8 hours have not elapsed since the last time the TWA reading was cleared, the average is still calculated over 8 hours. The missing time is assigned a 0 value for readings. If the lunch break feature is turned off, the TWA is cleared when the EAGLE 2 is turned off.

The lunch break feature enables the EAGLE 2 to remember TWA readings when it is turned off so it can continue them when it is turned on again. See “Turning On the EAGLE 2” on page 27

## View Alarm Settings Screen

The View Alarm Settings Screen gives you the option to view the gas alarm settings for all active channels.

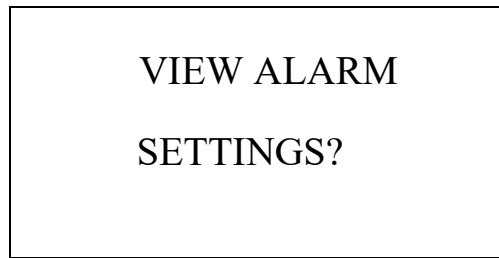

To view the gas alarm settings, do the following:

1. With the View Alarm Settings Screen displayed, press and release the AIR ▲ YES button. The following screen appears showing Channel 1 alarm points.

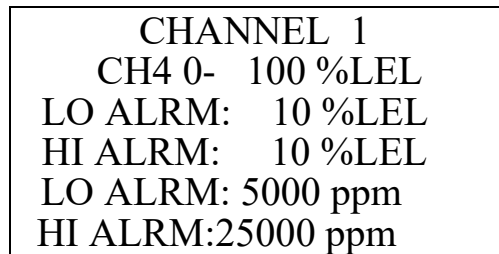

2. If the channel description is too long to fit across the screen, press and release the POWER ENTER RESET button to view the remainder of the displayed channel's description. Press and release the POWER ENTER RESET button again to return to the previous screen.

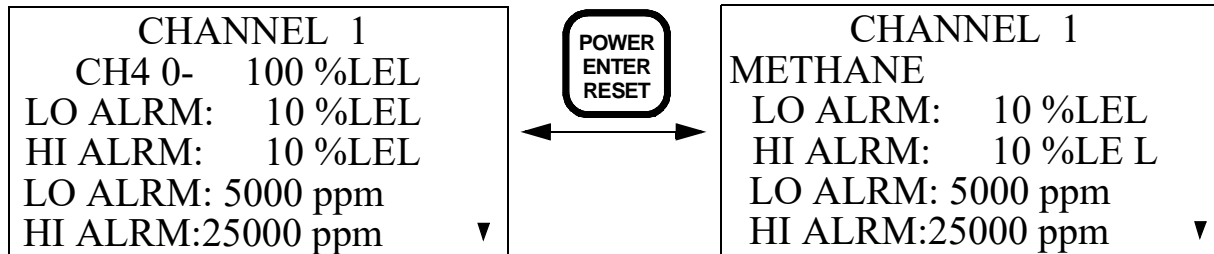

3. If the number of alarm settings is too many to display on one screen, a down arrow will appear in the lower right corner of the display indicating that there are additional alarm points. Press and release the RANGE ▼ SHIFT button to scroll down and display the remainder of the gas alarm settings for the displayed channel and again to return to the previous screen.

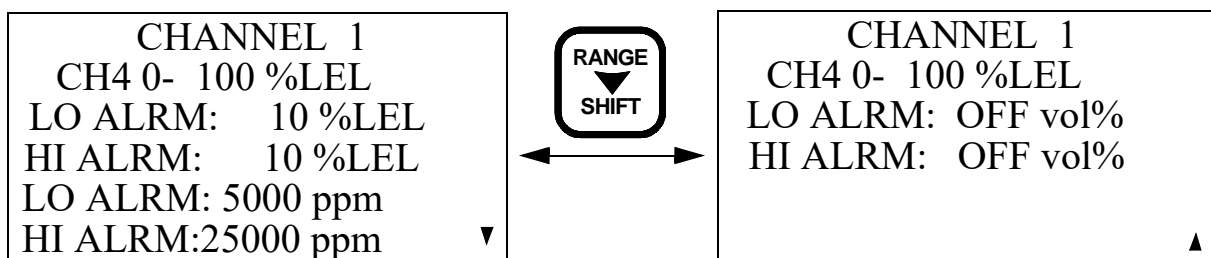

4. Press and release the AIR ▲ YES button to scroll through screens that display the rest of the active channels' alarm settings.

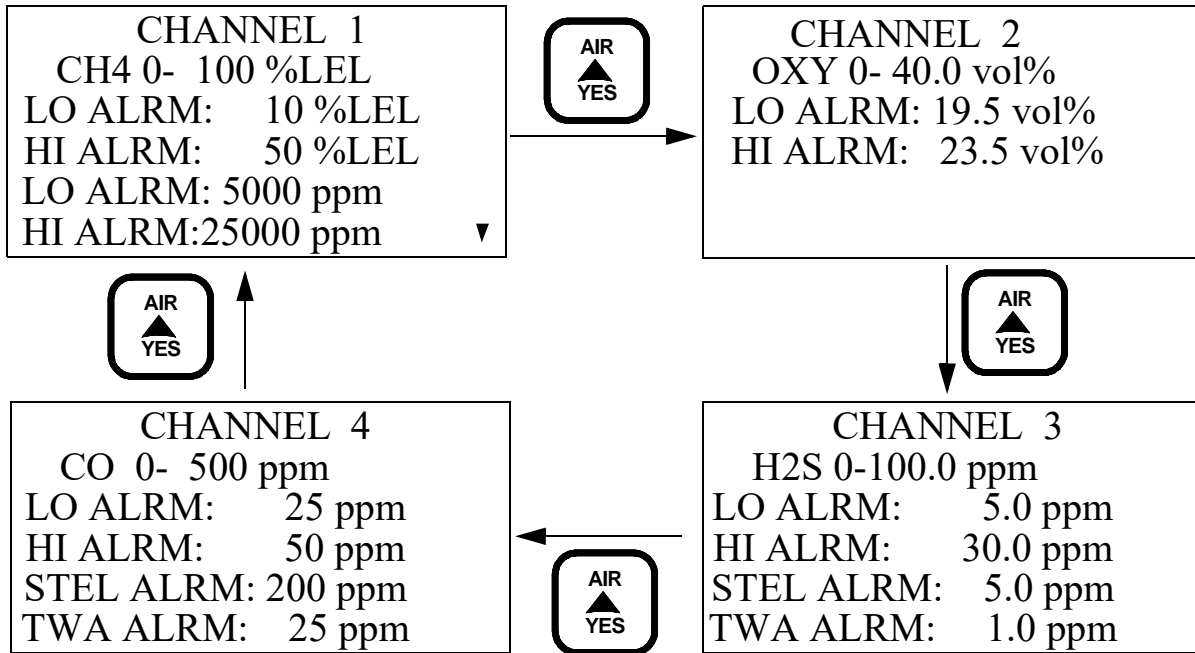

### Select User ID Screen

This screen displays only if USER/STATION ID in the Setup Mode menu is set to ON (see “Turning the User/Station ID Function On or Off” on page 109). Use this screen to select a user ID from the user ID list in the EAGLE 2’s memory. The current user ID is displayed. A user ID can be up to 16 characters long. The EAGLE 2 can store up to 32 user IDs.

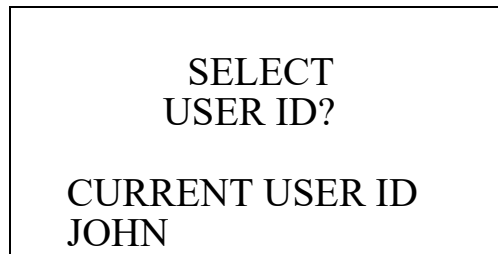

The user ID provides a way to identify the EAGLE 2 user during a data logging session. If the user ID is changed during an operating session, a new data session is initiated with the new user ID attached to it. This allows you to change the user ID during operation and have each user ID that was used during an operating session saved for the corresponding data. See the Eagle 2 Data Logger Management Program Operator’s Manual for a detailed description of data logging and the user ID.

The user ID list cannot be edited using the EAGLE 2 user interface. The Eagle 2 Maintenance Data Loader Program is required to define or change user IDs in the user ID list. For a detailed description of editing the list of user IDs stored in the EAGLE 2, see the Eagle 2 Maintenance Data Loader Program Operator’s Manual.

To select a different user ID:

1. With the Select User ID Screen displayed, press and release the AIR ▲ YES button. A screen appears that includes the current user ID which is indicated by the cursor next to it.

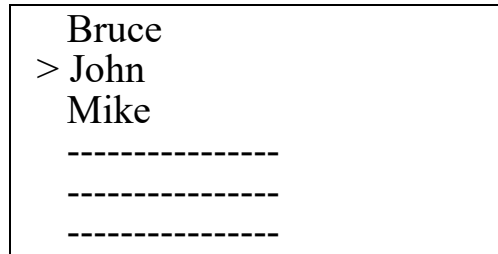

The user IDs are displayed in groups of six. The previous group of six is displayed when the cursor is moved up past the top of the LCD. The next group of six is displayed when the cursor is moved down past the bottom of the LCD. The list will not “wrap around” to the previous screen if the cursor is moved up from the first user ID or to the next screen if the cursor is moved down from the last user ID. Any of the user IDs in the list that have not been changed from the factory setting will be shown as dashes (-).

2. Use the AIR ▲ YES and RANGE ▼ SHIFT buttons to move the cursor up and down the screen and scroll through the available user IDs to find the desired user ID.
3. When the desired user ID is displayed, place the cursor next to it, press and release the POWER ENTER RESET button.

**NOTE:** To exit the selection screen without saving a change, press and release the DISPLAY ADJUST NO button. You will return to the Select User ID screen without saving the user ID change.

4. The unit will save the selected user ID as the current one and proceed to the Select Station ID Screen.

## Select Station ID Screen

This screen displays only if USER/STATION ID in the Setup Mode menu is set to ON (see “Turning the User/Station ID Function On or Off” on page 109). Use this screen to select a station ID from the station ID list in the EAGLE 2’s memory. The current station ID is displayed. A station ID can be up to 16 characters long. The EAGLE 2 can store up to 128 station IDs.

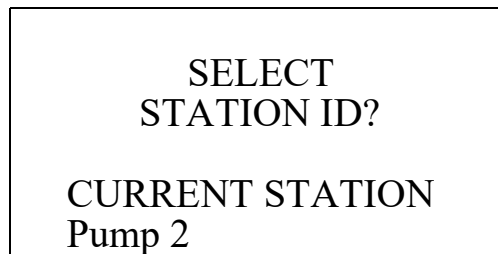

The station ID provides a way to identify a location where monitoring was done during a data logging session. If the station ID is changed during an operating session, a new data session is initiated with the new station ID attached to it. This allows you to change the station ID during operation and have each station ID that was used during an operating session saved for the corresponding data. See the Eagle 2 Data Logger Management Program Operator’s Manual for a detailed description of data logging and the station ID.

The station ID list cannot be edited using the EAGLE 2 user interface. The Eagle 2 Maintenance Data Loader Program is required to define or change station IDs in the station ID list. For a detailed description of editing the list of station IDs stored in the EAGLE 2, see the Eagle 2 Maintenance Data Loader Program Operator's Manual.

To select a different station ID:

1. With the Select Station ID Screen displayed, press and release the AIR ▲ YES button. A screen appears that includes the current station ID which is indicated by the cursor next to it.

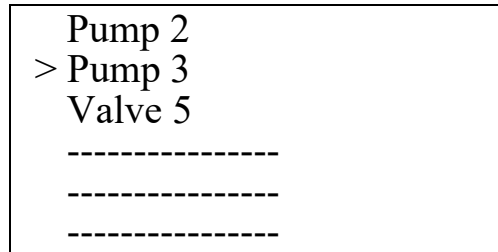

The station IDs are displayed in groups of six. The previous group of six is displayed when the cursor is moved up past the top of the LCD. The next group of six is displayed when the cursor is moved down past the bottom of the LCD. The list will not “wrap around” to the previous screen if the cursor is moved up from the first station ID or to the next screen if the cursor is moved down from the last station ID. Any of the station IDs in the list that have not been changed from the factory setting will be shown as dashes (-).

2. Use the AIR ▲ YES and RANGE ▼ SHIFT buttons to move the cursor up and down the screen and scroll through the available station IDs to find the desired station ID.
3. When the desired station ID is displayed, place the cursor next to it, press and release the POWER ENTER button.

**NOTE:** To exit the selection screen without saving a change, press and release the DISPLAY ADJUST NO button. You will return to the Select Station ID screen without saving the station ID change.

4. The unit will save the selected station ID as the current one and proceed to the Time in Operation Screen.

## Time in Operation Screen

The Time In Operation Screen displays the length of time since the EAGLE 2 was turned on if the lunch break feature is turned off. With the lunch break feature turned off, the time in operation is reset when the EAGLE 2 is turned off. See “Updating the Lunch Break Setting” on page 118 for a description of the lunch break feature.

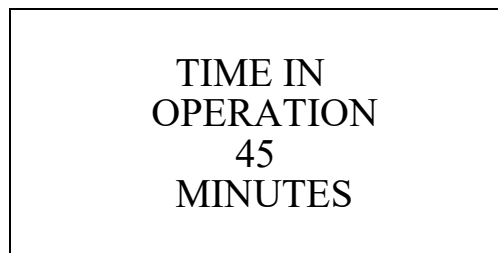

If the lunch break feature is turned on, the time in operation will only be reset if you do not choose to resume the peak and TWA measurements when the EAGLE 2 is turned on in the Resume Measurement Screen described in Step 7 on page 28 in “Turning On the EAGLE

2”. If you choose to resume the peak and TWA measurements during startup, the EAGLE 2 will include the time in operation when the unit was last turned off in the current time in operation.

### **Date/Time Screen**

The Date/Time Screen displays the current date and time.

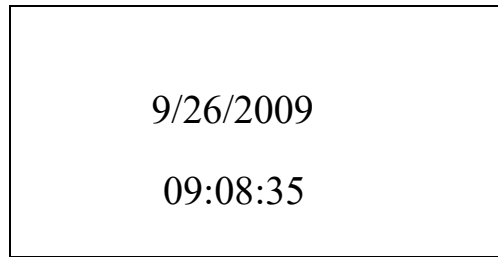

### **Data Logging Screen**

**CAUTION:** *Once you clear the data logger, you cannot retrieve any data previously stored in the data logger.*

The Data Logging screen displays the time remaining until the data logger memory is full and asks if you want to clear the data logger memory.



To return to Measuring Mode while at the Data Logging Screen, press and release the DISPLAY ADJUST NO button.

To clear the data logger memory, do the following:

1. With the Data Logging Screen displayed, press and release the AIR ▲ YES button. The following screen appears asking you to confirm that you want to clear the data logger memory.

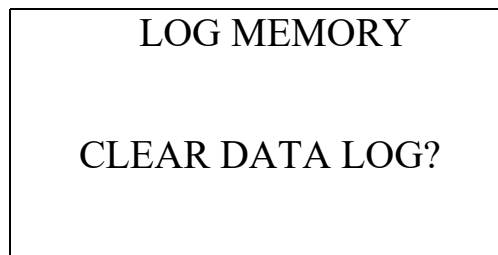

2. If you do not want to clear the data logger memory at this point or at Step 3 below, press and release the DISPLAY ADJUST NO button. The unit will return to Measuring Mode.

3. If you want to clear the data logger memory, press and release the AIR ▲ YES button. The following screen appears asking you to reconfirm that you want to clear the data logger memory.

LOG MEMORY  
ARE YOU SURE YOU  
WANT TO PERMANENTLY  
ERASE DATA FROM  
MEMORY?

4. If you want to clear the data logger memory, press and release the AIR ▲ YES button. The unit will display the following screen as it clears the data.

PLEASE WAIT  
.....

5. The periods below “PLEASE WAIT” will disappear one at a time from right to left as the data is cleared. When the last period disappears, the unit is finished clearing the data and will display the following screen for a few seconds, then return to Measuring Mode.

CLEARED

---

## Data Logging

**NOTE:** The EAGLE 2 only logs data while in Normal Mode. If the EAGLE 2 is used in Leak Check Mode or Bar Hole Mode, no downloadable data will be logged while it is in either of these two modes.

The EAGLE 2 features the ability to log data to its internal memory and download it to a computer via the infrared communications port on the front of the unit. It logs gas readings during normal operation, alarm data, and calibration data.

To utilize the EAGLE 2’s downloading capability, you will need the Eagle 2 Data Logger Management Program and a computer with an infrared port or a USB port that runs one of the following operating systems: Windows 7, Windows 8, or Windows 10. If your computer has an infrared port, then no additional accessories are needed to download data from the EAGLE 2. If your computer does not have an infrared port but does have a USB port, a USB/IrDA adapter cable can be used to download data from the EAGLE 2 using the USB port. The Eagle 2 Data Logger Management Program is available at [www.globaltestsupply.com](http://www.globaltestsupply.com). The USB/IrDA adapter cable is also available from RKI

Instruments, Inc.

The data logging capacity depends on how often the EAGLE 2 stores data, how many channels are active, and how often the EAGLE 2 is turned on and off. The table below illustrates how much data logging time is available for the various interval times. It assumes that the unit is setup with four sensors, is only turned on once, and there are no alarm occurrences. See “Updating the Data Log Interval Setting” on page 111 for instructions on setting the data logging interval time.

**Table 8: Data Logging Capacity, 4-gas EAGLE 2**

<b>Interval Time</b>	<b>Data Logging Time</b>
5 seconds	239 hours (10 days)
10 seconds	479 hours (20 days)
20 seconds	959 hours (40 days)
30 seconds	1439 hours (60 days)
1 minute	2879 hours (120 days)
3 minutes	8639 hours (360 days)
5 minutes	14,399 hours (600 days)
10 minutes	28,798 hours (2,000 days)

For a complete description of the Data Logger Management Program and procedures for downloading data to a computer, see the Eagle 2 Data Logger Management Program Operator’s Manual.

# Chapter 4: Calibration Mode

---

## Overview

This section describes the EAGLE 2 in Calibration Mode. In Calibration Mode, you can move through a menu of screens to do the following:

- Perform a span adjustment on all channels simultaneously using auto calibration
- Perform a span adjustment on one channel at a time using single calibration
- Perform a fresh air (zero) adjustment

**NOTE:** You can set up the EAGLE 2 to alert you during the startup sequence when calibration is due. See “Updating the Calibration Reminder Setting” on page 113

**CAUTION:** *BEFORE EACH DAY’S USAGE, SENSITIVITY IN THE %LEL RANGE MUST BE TESTED ON A KNOWN CONCENTRATION OF THE COMBUSTIBLE TARGET GAS, METHANE, EQUIVALENT TO 25 - 50% OF FULL SCALE CONCENTRATION (the %LEL full scale is 100 %LEL). ACCURACY MUST BE WITHIN -0 to + 20% OF ACTUAL. ACCURACY MAY BE CORRECTED BY FOLLOWING THE CALIBRATION INSTRUCTIONS FOR THE COMBUSTIBLE CHANNEL BELOW.*

If the combustible channel passes the above response test and does not require calibration, the unit should still be calibrated periodically. The optimum frequency of calibration depends heavily on how the EAGLE 2 is used. For example, instruments used daily may need to be calibrated weekly or monthly, while instruments that are used only a few times a year may need to be calibrated before each use. Typical calibration frequencies range from monthly to quarterly. Make sure to perform the combustible channel response test as described above and make sure to develop a calibration schedule tailored to your application that takes this test and required calibration resulting from this test into account.

---

## Calibration Supplies and Equipment

To calibrate the EAGLE 2, you will need:

- Known calibrating samples of the gases being detected. The combustible and toxic gas samples should have concentrations between 10 and 50% of the full scale value. For example, if you are calibrating the catalytic combustible gas channel, your calibration cylinder should have a combustible gas concentration between 10% LEL and 50% LEL. An oxygen-free source, such as 100% nitrogen is recommended for setting the oxygen zero.

**NOTE:** The catalytic combustible channel can be set up for and calibrated to a number of different combustible gases. See “Configuring the Combustible Gas” on page 101 for instructions. Be sure that you are using an appropriate calibration cylinder for the target gas of the catalytic combustible channel.

**CAUTION:** *When using auto calibration with the standard 4-gas EAGLE 2, although the EAGLE 2 can be calibrated with an oxygen concentration of up to 19.5%, RKI Instruments, Inc. recommends that the multi-gas cylinder have an oxygen concentration in the range of 10% - 16% oxygen.*

- A demand-flow regulator to provide adequate sample gas flow

**WARNING:** ***RKI Instruments, Inc. recommends that you dedicate a regulator for use with chlorine (Cl<sub>2</sub>) gas and that you do not use that dedicated regulator for any other gases, particularly hydrogen sulfide (H<sub>2</sub>S).***

- Non-absorbent tubing
- A 24 inch humidifier tube if you are calibrating the catalytic combustible channel with a gas concentration of 1000 ppm or lower

**WARNING:** *If you are using a calibration kit that includes a gas bag and a fixed flow regulator or dispensing valve, do not apply gas directly to the EAGLE 2 with the regulator or dispensing valve or damage to the pump will result. See “Appendix A: Calibrating with a Sample Bag” on page 82 for instructions to properly use a gas bag kit.*

To calibrate the %LEL, oxygen, CO, and H<sub>2</sub>S sensors at the same time, automatically, with no need for a zero-oxygen source, you can use the auto calibration feature with a 4-gas cylinder. If the H<sub>2</sub>S channel is not active, then a 3-gas cylinder may be used for auto calibration. This chapter includes instructions for auto calibration with a demand-flow regulator and a 4-gas cylinder. This chapter also includes instructions for calibrating one channel at a time using single calibration.

---

## Entering Calibration Mode

To enter Calibration Mode, do the following:

1. Find a fresh-air environment. This is an environment free of toxic or combustible gases and of normal oxygen content (20.9%).
2. While in Measuring Mode, press and hold the RANGE ▼ SHIFT button, then press the DISPLAY ADJUST NO button and release both buttons.
3. If the unit prompts you for the password, enter it by using the AIR ▲ YES and RANGE ▼ SHIFT buttons to select each password number and then pressing and releasing POWER ENTER RESET to enter the number and move on to the next one.
4. The Calibration Mode Screen displays with the cursor next to **AUTO CALIBRATION**.

CALIBRATION MODE

> AUTO CALIBRATION  
SINGLE CALIBRATION  
PERFORM AIR ADJUST  
NORMAL OPERATION

**NOTE:** The following screens illustrate a four-gas EAGLE 2 for detection of CH<sub>4</sub> (%LEL using catalytic sensor), oxygen, H<sub>2</sub>S, and CO. Your EAGLE 2 may display slightly different screens.

---

## Calibrating Using the Auto Calibration Method

This method allows you to calibrate the CH<sub>4</sub> (%LEL sensor), oxygen, H<sub>2</sub>S, and CO sensors simultaneously. It is designed for use with the RKI 4-gas calibration cylinder and is the quickest and easiest method to calibrate the EAGLE 2.

### Setting the Fresh Air Reading

1. While in the Calibration Mode Screen, move the cursor to the **PERFORM AIR ADJUST** menu item by using the RANGE ▼ SHIFT button.

CALIBRATION MODE

AUTO CALIBRATION  
SINGLE CALIBRATION  
> PERFORM AIR ADJUST  
NORMAL OPERATION

2. Press and release the POWER ENTER RESET button. The following screen appears.

PERFORM  
AIR ADJUST?

3. Press and release the AIR ▲ YES button to continue.  
If you do not want to continue, press the DISPLAY ADJUST NO button and the unit will return to the Calibration Mode Screen.
4. The EAGLE 2 will indicate that it is adjusting the zero reading for a few seconds, then indicate that the operation is complete before returning to the Calibration Mode Screen.

ADJUSTING ZERO  
RELEASE AIR BUTTON



ADJUSTING ZERO  
COMPLETE



CALIBRATION MODE  
AUTO CALIBRATION  
SINGLE CALIBRATION  
> PERFORM AIR ADJUST  
NORMAL OPERATION

## Performing a Span Adjustment in Auto Calibration

1. Install the demand flow regulator onto the calibration cylinder.
2. Connect the sample tubing to the demand flow regulator.
3. Install the probe on the EAGLE 2 inlet fitting. Make sure the probe is complete with internal O-ring and membrane and that the two halves of the probe are tightened firmly together to avoid leaks that can affect the calibration. See Figure 21, “Replacing the Particle Filter and Hydrophobic Filter Disk” on page 72 for an illustration of the internal parts of the probe.
4. Move the cursor next to the **AUTO CALIBRATION** menu item by using the AIR ▲ YES button.

```
CALIBRATION MODE
> AUTO CALIBRATION
  SINGLE CALIBRATION
  PERFORM AIR ADJUST
  NORMAL OPERATION
```

5. Press and release the POWER ENTER RESET button to display the Calibration Gas Values Screen.

```
CAL GAS VALUES
CH4   50 %LEL
OXY  12.0 vol%
H2S   25.0 ppm
CO    50 ppm
ENTER TO BEGIN CAL
```

The gas concentrations displayed in the Calibration Gas Values Screen must match the gas concentrations listed on the 4-gas calibration cylinder.

If *all* concentrations match, go to Step 16.

If *one or more* concentrations *do not* match, continue with Step 6.

If you do not want to continue with the calibration, press and release the DISPLAY ADJUST NO button to return to the Calibration Mode Screen.

**NOTE:** The RKI 4-gas cylinder typically contains 12% O<sub>2</sub> by volume. When using the auto calibration method, be sure to set the “OXY” auto calibration value to agree with the concentration listed on the cylinder’s label, not zero.

6. To adjust the values on the screen, press and hold the RANGE ▼ SHIFT button, then press the DISPLAY ADJUST NO button and release both. The following screen appears with the cursor next to **CH4**.

```
ADJUST AUTO
CALIBRATION VALUES
> CH4   50 %LEL
  OXY  12.0 vol%
  H2S   25.0 ppm
  CO    50 ppm ▼
```

7. Place the cursor next to the channel whose gas value you want to change using the AIR ▲ YES and RANGE ▼ SHIFT buttons.
8. Press and release the POWER ENTER RESET button to select the channel. The calibration gas value begins to flash.
9. Use the AIR ▲ YES and RANGE ▼ SHIFT buttons to adjust the calibration gas setting to the desired value.

**NOTE:** The calibration gas value cannot be set lower than the low alarm setting. If the calibration gas value listed on the calibration cylinder is lower than the current low alarm setting, enter Setup Mode and change the low alarm setting. See “Updating the Alarm Point Settings” on page 106 for instructions. If you need to change the alarm point setting only to perform a calibration, make sure that you change the alarm point setting back to its original value once the calibration has been performed.

10. Press and release the POWER ENTER RESET button to save the change. The calibration gas value stops flashing.
11. Repeat Step 7 through Step 10 for any other channels that need to be changed.
12. When you are done adjusting the calibration gas values, move the cursor down past the bottom of the screen next to **END**.

ADJUST AUTO  
CALIBRATION VALUES  
> END ▲

13. Press and release the POWER ENTER RESET button. The following screen appears.

DO YOU WANT TO  
STORE NEW VALUE(S)  
IN MEMORY FOR  
FUTURE CALIBRATIONS?  
  
PRESS YES OR NO

14. If you select YES by pressing and releasing the AIR ▲ YES button, the changes that you made will be saved in the EAGLE 2’s memory as the new auto calibration gas values.

If you select NO by pressing and releasing the DISPLAY ADJUST NO button, the changes you made will be used for any calibrations performed during the current operating session only. The EAGLE 2 will delete the changes when the unit is turned off and will load the previous set of auto calibration values when it is turned on again.

15. When you make your selection and press the desired button, the unit returns to the Calibration Gas Values Screen.

CAL GAS VALUES		
CH4	50	%LEL
OXY	12.0	vol%
H2S	25.0	ppm
CO	50	ppm
ENTER TO BEGIN CAL		

16. Press and release the POWER ENTER RESET button to proceed to the Calibration In Process Screen with **CAL IN PROCESS** flashing.

CAL IN PROCESS		
CH4	0	%LEL
OXY	20.9	vol%
H2S	0.0	ppm
CO	0	ppm
ENTER WHEN DONE		

If you do not want to proceed with the calibration, press and release the DISPLAY ADJUST NO button to return to the Cal Gas Values Screen.

If you do want to continue with the calibration, proceed to the next step.

17. Connect the tubing from the demand flow regulator to the rigid tube on the probe. Allow the EAGLE 2 to draw gas for one minute.

**NOTE:** If you are calibrating the catalytic combustible channel with a gas concentration of 1000 ppm or lower, you must use a 24 inch humidifier tube to connect the demand flow regulator to the rigid tube on the probe.

18. Press and release the POWER ENTER RESET button to set the span adjustment for each channel to the programmed values.

19. If all channels passed calibration, the following screen sequence occurs.

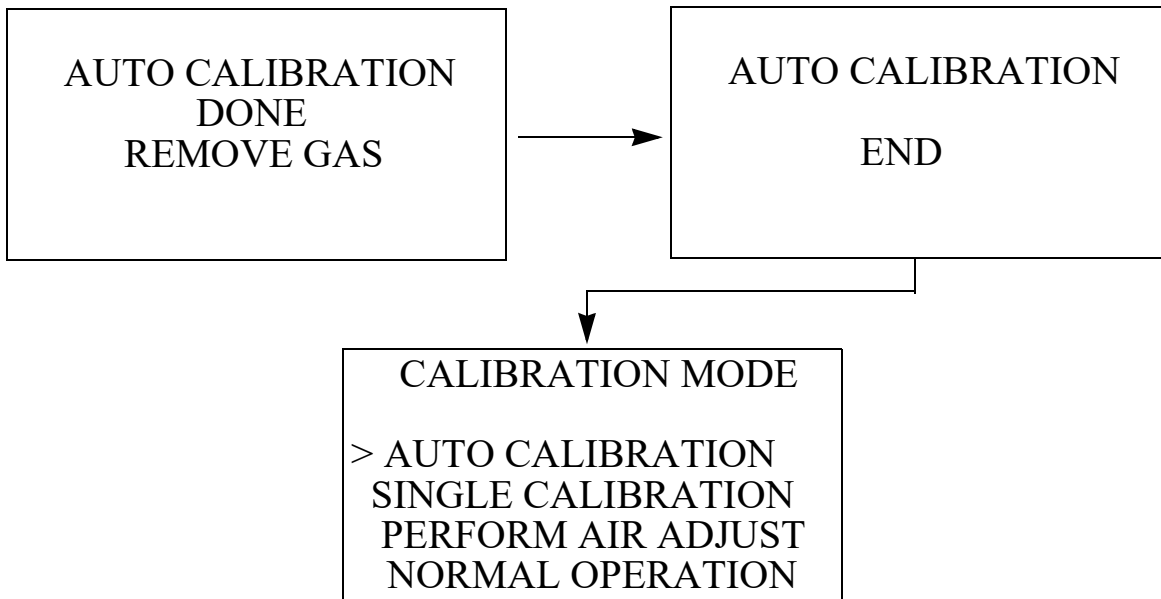

If any of the sensors cannot be adjusted to the proper value, a screen displays that indicates a calibration failure and lists the sensor(s) that failed to calibrate. In the example below, the oxygen and H<sub>2</sub>S channels failed calibration. The other sensors calibrated normally.

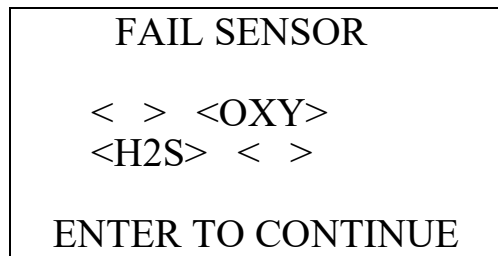

The buzzer and alarm LED arrays activate in a double pulsing pattern. Press and release the POWER ENTER RESET button to reset the alarm and return to the Calibration Mode Screen. Attempt to calibrate again. If the failure continues, investigate the cause. See "Troubleshooting" on page 67.

20. Disconnect the tubing from the probe.
21. Unscrew the demand flow regulator from the calibration cylinder.
22. Use the RANGE ▼ SHIFT button to place the cursor next to the **NORMAL OPERATION** menu option, then press and release the POWER ENTER RESET button to return to Measuring Mode.

---

## Calibrating Using the Single Calibration Method

Single Calibration allows you to calibrate one channel at a time. This is useful if you only want to calibrate one or two channels.

### Setting the Fresh Air Reading

1. While in the Calibration Mode Screen, move the cursor to the **PERFORM AIR ADJUST** menu item by using the RANGE ▼ SHIFT button.

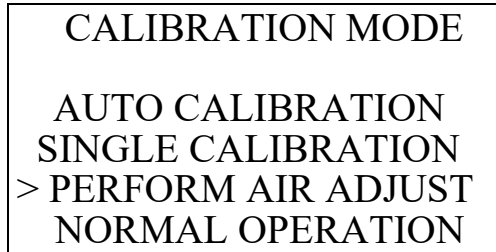

CALIBRATION MODE  
AUTO CALIBRATION  
SINGLE CALIBRATION  
> PERFORM AIR ADJUST  
NORMAL OPERATION

2. Press and release the POWER ENTER RESET button. The following screen appears.

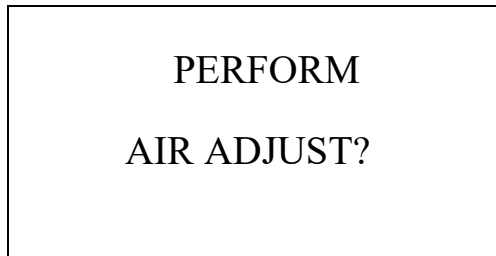

PERFORM  
AIR ADJUST?

3. Press and release the AIR ▲ YES button to continue.

If you do not want to continue, press the DISPLAY ADJUST NO button and the unit will return to the Calibration Mode Screen.

- The EAGLE 2 will indicate that it is adjusting the zero reading for a few seconds, then indicate that the operation is complete before returning to the Calibration Mode Screen.

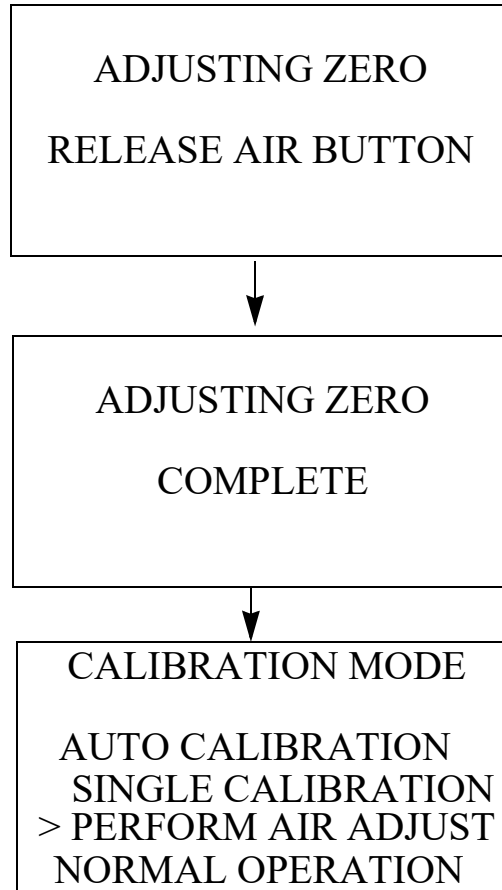

### Performing a Span Adjustment in Single Calibration

- Install the demand flow regulator onto the calibration cylinder.
- Connect the sample tubing to the demand flow regulator.
- Install the probe on the EAGLE 2 inlet fitting. Make sure the probe is complete with internal O-ring and membrane and that the two halves of the probe are tightened firmly together to avoid leaks that can affect the calibration. See Figure 21, “Replacing the Particle Filter and Hydrophobic Filter Disk” on page 72 for an illustration of the internal parts of the probe.
- Move the cursor next to the **SINGLE CALIBRATION** menu item by using the AIR ▲ YES button.

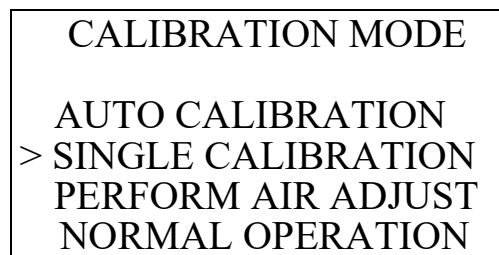

5. Press and release the POWER ENTER RESET button. The Select Sensor Screen appears with the cursor flashing.

```
SELECT SENSOR
TO CALIBRATE
>ESCAPE
CH4  OXY
H2S  CO
```

6. Move the cursor next to the sensor you want to calibrate with the AIR ▲ YES and RANGE ▼ SHIFT buttons. In the example below, the CH<sub>4</sub> sensor is selected for span adjustment.

```
SELECT SENSOR
TO CALIBRATE
ESCAPE
>CH4  OXY
H2S  CO
```

If you do not want to proceed with the span adjustment, press and release the DISPLAY ADJUST NO button or place the cursor next to **ESCAPE** and press and release POWER ENTER RESET to return to the Calibration Mode Screen.

To proceed with the calibration, continue with the next step.

7. Press and release the POWER ENTER RESET button to proceed to the Single Calibration Gas Value Screen for the selected channel. The calibration gas value is flashing.

```
SINGLE CALIBRATION

CH4  50 %LEL
UP/DOWN TO ADJUST
CALIBRATION VALUE
ENTER WHEN DONE
```

8. If necessary, adjust the calibration gas value to match the cylinder concentration with the AIR ▲ YES and RANGE ▼ SHIFT buttons.

**NOTE:** The calibration gas value cannot be set lower than the low alarm setting. If the calibration gas value listed on the calibration cylinder is lower than the current low alarm setting, enter Setup Mode and change the low alarm setting. See “Updating the Alarm Point Settings” on page 106 for instructions. If you need to change the alarm point setting only to perform a calibration, make sure that you change the alarm point setting back to its original value once the calibration has been performed.

9. Press and release the POWER ENTER RESET button to proceed to the Single Calibration Apply Gas Screen. **CAL IN PROCESS** is flashing.

SINGLE CALIBRATION  
APPLY GAS  
CH4 0 %LEL  
  
CAL IN PROCESS  
ENTER WHEN DONE

10. Connect the tubing from the demand flow regulator to the rigid tube on the probe. Allow the EAGLE 2 to draw gas for one minute.

**NOTE:** If you are calibrating the catalytic combustible channel with a gas concentration of 1000 ppm or lower, you must use a 24 inch humidifier tube to connect the demand flow regulator to the rigid tube on the probe.

11. Press and release the POWER ENTER RESET button to perform the calibration.
12. When the span adjustment is made, the EAGLE 2 calculates the range of adjustment, minimum and maximum, it could have made based on its response level to the applied gas. This calculated range is independent of the calibration gas value that was entered in Step 8 and Step 9 above. The adjustment range is included on the result screen to indicate the condition of the sensor. If the calibration gas value is in the adjustment range, the span adjustment will pass. If the calibration gas value is out of the adjustment range, the span adjustment will fail.

If the span adjustment is successful, the following screens display.

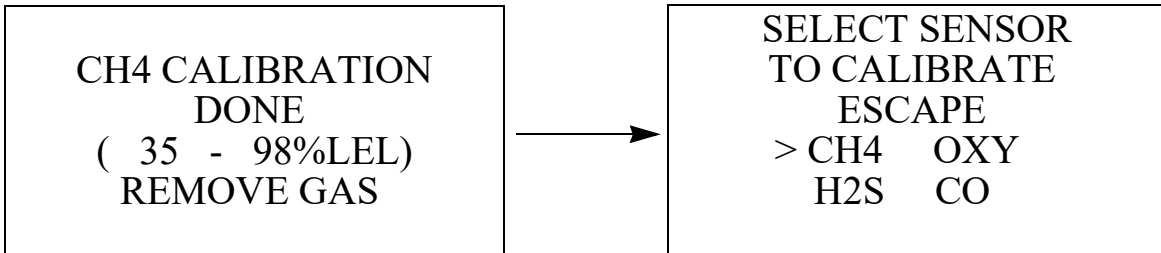

In the example above, the EAGLE 2 could have adjusted the reading as low as 35 %LEL and as high as 98 %LEL.

If the span adjustment is not successful, a screen displays that indicates a calibration failure.

FAILED SENSOR  
( 11 - 43%LEL)  
<CH4>  
  
ENTER TO CONTINUE

In the example above, the EAGLE 2 could have adjusted the reading as low as 11 %LEL and as high as 43 %LEL. Since the calibration gas value entered was 50 %LEL, the unit failed the span adjustment. The buzzer and alarm LED arrays activate in a double pulsing pattern. Press and release the POWER ENTER RESET button to reset the alarm and return to the Select Sensor Screen. Attempt to calibrate again. If the failure continues, investigate the cause. See “Troubleshooting” on page 67.

**NOTE:** The adjustment range will only appear in the calibration results screen if the Span Factor item in Setup Mode is set to ON. If the Span Factor is set to OFF, the adjustment range will not appear.

13. Disconnect the tubing from the EAGLE 2's probe.
14. Repeat Step 6 through Step 13 for any other channels you want to calibrate. Make sure you use an appropriate calibration cylinder for each sensor.

**CAUTION:** *When calibrating the oxygen sensor, verify the concentration of oxygen listed on the cylinder's label. For oxygen-free samples (100% nitrogen for example), set the oxygen calibration value to 0.0%.*

15. After the last channel is calibrated, disconnect the calibration tubing from the probe, then unscrew the demand flow regulator from the calibration cylinder.
16. With the Select Sensor Screen displayed, place the cursor next to **ESCAPE** using the AIR ▲ YES button.

SELECT SENSOR  
TO CALIBRATE  
>ESCAPE  
CH4 OXY  
H2S CO

17. Press and release the POWER ENTER RESET button to return to the Calibration Mode Screen.
18. Use the RANGE ▼ SHIFT button to place the cursor next to the **NORMAL OPERATION** menu item, then press and release the POWER ENTER RESET button to return to Measuring Mode.

# Chapter 5: Maintenance

## Overview

This chapter describes troubleshooting procedures for the EAGLE 2. It also includes procedures for replacing and recharging the batteries and replacing various consumable parts.

**WARNING:** *RKI Instruments, Inc. recommends that service, calibration, and repair of RKI instruments be performed by personnel properly trained for this work. Replacing sensors and other parts with original equipment does not affect the intrinsic safety of the instrument.*

## Troubleshooting

The troubleshooting table describes error messages, symptoms, probable causes, and recommended action for problems you may encounter with the EAGLE 2.

**Table 9: Troubleshooting the EAGLE 2**

Symptoms	Probable Causes	Recommended Action
<ul style="list-style-type: none"><li>The LCD is blank.</li></ul>	<ul style="list-style-type: none"><li>The unit may have been turned off.</li><li>The alkaline batteries may need to be replaced or the Ni-MH batteries recharged.</li></ul>	<ol style="list-style-type: none"><li>To turn on the unit, press and briefly hold the POWER ENTER RESET button.</li><li>If the unit does not turn on, replace the alkaline batteries or recharge the Ni-MH batteries.</li><li>If the difficulties continue, contact RKI Instruments, Inc. for further instruction.</li></ol>
<ul style="list-style-type: none"><li>The LCD shows abnormally high or low readings but other gas detection instruments do not.</li></ul>	<ul style="list-style-type: none"><li>The EAGLE 2 may need to be recalibrated.</li><li>The sensor for the affected channel(s) may need replacement.</li></ul>	<ol style="list-style-type: none"><li>Recalibrate the unit.</li><li>If the difficulties continue, replace the sensor for the affected channel(s) and calibrate the affected channel(s).</li><li>If the difficulties continue, contact RKI Instruments, Inc. for further instruction.</li></ol>
<ul style="list-style-type: none"><li>The unit indicates flow failure and does not recover when POWER ENTER RESET is pressed and released.</li></ul>	<ul style="list-style-type: none"><li>The probe tube is clogged.</li><li>The hydrophobic filter disk in the probe is dirty.</li><li>The sample hose has a kink or obstruction.</li><li>The internal hydrophobic filter is dirty.</li><li>The pump is malfunctioning.</li></ul>	<ol style="list-style-type: none"><li>Inspect the probe tube for any obstructions.</li><li>Inspect the hydrophobic filter disk in the probe and replace if necessary.</li><li>Inspect the sample hose for kinks or obstructions and replace if necessary.</li><li>Inspect the internal hydrophobic filter and replace if necessary.</li><li>If difficulties continue, contact RKI Instruments, Inc. for further instruction.</li></ol>

**Table 9: Troubleshooting the EAGLE 2**

<b>Symptoms</b>	<b>Probable Causes</b>	<b>Recommended Action</b>
<ul style="list-style-type: none"> <li>• Auto calibration or single calibration fails.</li> </ul>	<ul style="list-style-type: none"> <li>• The auto calibration values may not match the cylinder gas concentrations (auto calibration only).</li> <li>• The charcoal filter is saturated causing an elevated CO reading.</li> <li>• The sample gas is not reaching the sensors because of a bad connection.</li> <li>• The calibration cylinder may be out of gas or is outdated.</li> <li>• The sensor for the affected channel(s) may need replacement.</li> </ul>	<ol style="list-style-type: none"> <li>1. Check all calibration tubing for leaks or for any bad connections.</li> <li>2. Make sure the EAGLE 2 has been properly set up for calibration.</li> <li>3. Change the charcoal filter.</li> <li>4. Verify that the calibration cylinder contains an adequate supply of fresh test sample.</li> <li>5. If the fail condition continues, replace the sensor(s).</li> <li>6. If the difficulties continue, contact RKI Instruments, Inc. for further instruction.</li> </ol>
<ul style="list-style-type: none"> <li>• Display indicates “SYSTEM FAIL 12” during startup.</li> </ul>	<ul style="list-style-type: none"> <li>• A memory error has occurred.</li> </ul>	<ol style="list-style-type: none"> <li>1. Press and hold the RANGE ▼ SHIFT button, then press the DISPLAY ADJUST NO button and release both. The Enter Password Screen will appear.</li> <li>2. Enter the password, “1994”, to proceed to the Set Default Screen.</li> <li>3. Press and release the AIR ▲ YES button twice to restore the defaults. See “Restoring the Default Settings” on page 117 for a description of issues to consider when restoring the defaults.</li> <li>4. If difficulties continue, contact RKI Instruments, Inc. for further instruction.</li> </ol>

## Replacing or Recharging the Batteries

**WARNING:** *To prevent ignition of a hazardous atmosphere, batteries must only be changed or charged in an area known to be nonhazardous.*

Replace or charge the batteries when the EAGLE 2 indicates that it is in low battery warning. When in low battery warning, BATT appears vertically along the left side the LCD.

CH4	0%LEL
B OXY	20.9vol%
A H2S	0.0ppm
T CO	0ppm
T	

### Replacing the Batteries

**NOTE:** Use Duracell Procell PC 1400 alkaline batteries, Duracell MN 1400 alkaline batteries, Energizer E93 or Energizer EN93, or RKI Instruments, Inc. 4 9-1330RK Ni-MH batteries to maintain the CSA classification of the EAGLE 2. Use of other batteries or mixing alkaline and rechargeable batteries will void the CSA classification and may void the warranty.

1. Turn off the EAGLE 2.

**WARNING:** *Do not remove the batteries while the EAGLE 2 is on.*

2. Loosen the battery case thumbscrew by turning it counterclockwise until it disengages from the bottom case. If necessary, use a coin or large flat blade screwdriver to loosen it.

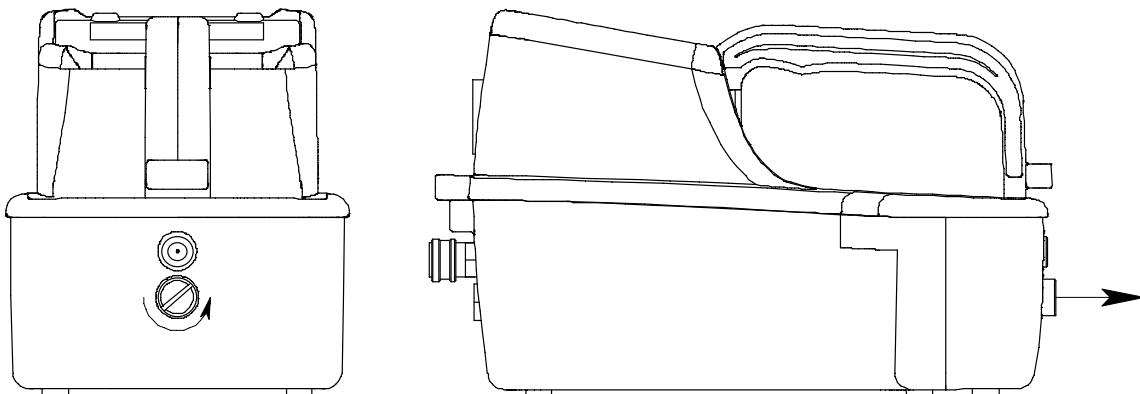

**Figure 18: Removing the Battery Case**

3. Pull the battery case away from the bottom case. The thumbscrew is captive and will not fall out.
4. Carefully remove the old batteries. Verify that the battery compartment and electrical contacts are clean.

- Carefully install the new C-size batteries. Follow the battery diagram inside the battery case. Make sure the batteries are pushed in all the way.

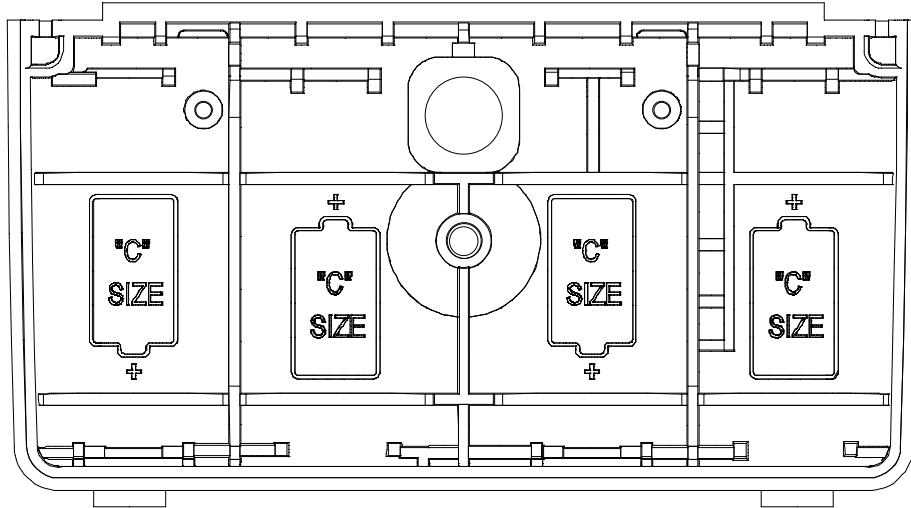

**Figure 19: Installing the Batteries**

- Reinstall the battery case onto the bottom case tightening the thumbscrew firmly by hand so that there is no visible gap between the battery case and the bottom case.

### **Recharging the Ni-MH Batteries**

**CAUTION:** Use with Ni-MH battery p/n 49-1330RK. Charge only with RKI charger model 49-2175RK, 49-2176RK, or 49-2177RK. Use of other rechargeable batteries or chargers or charging of other rechargeable batteries in the EAGLE 2 will void the warranty.

**WARNING:** Do not plug the charger cable into a battery pack that contains alkaline batteries. Do not attempt to charge alkaline batteries.

The charging module can either be used with an AC adapter or a vehicle plug DC adapter. Both adapters plug into the module which then plugs into the EAGLE 2.

- Plug the power adapter into either an AC outlet or into a vehicle outlet depending on which charger is being used.
- Make sure the switch on the module is set to “BATT. CHARGER”.
- Make sure the EAGLE 2 is off.
- Make sure the adapter and module are connected.

5. Insert the module's round plug into the EAGLE 2's charging jack as shown in Figure 20 below.

**NOTE:** The battery pack does not need to be attached to the EAGLE 2 case in order to charge. It may be charged separately. This allows a spare battery pack to be charged while the EAGLE 2 is in use.



**Figure 20: Connecting the EAGLE 2 to the Charger**

6. While the batteries are charging, the green indicator LED will be off and the amber one will be on.
7. The charging module has an internal timeout feature set at 9.5 hours. A full charge should be reached in less than 9.5 hours. When a full charge has been reached, both the green and yellow LEDs will be on.
8. If charging should fail, the green indicator LED will be off and the amber one will be blinking.

Table 10 summarizes the battery charger conditions.

**Table 10: Battery Charger Conditions**

Amber LED	Green LED	Status
ON	OFF	CHARGING
ON	ON	READY/FULL
BLINKING	OFF	FAIL
OFF	ON	CONTINUOUS OPERATION

---

## Replacing the Hydrophobic Probe's Particle Filter and Hydrophobic Filter Disk

Inspect the probe's internal components if you notice that the EAGLE 2's pump sounds bogged down or if an unexplained low flow alarm occurs. Replace the particle filter if it appears to be dirty. Replace the hydrophobic filter disk if it appears dirty or saturated with liquid. Replace the O-rings in the probe if either of them appears damaged.

1. Grasp each end of the clear probe body firmly and unscrew the two halves from each other. One half includes a plastic tube fitting and the probe tube. The other half includes a metal fitting that mates with the EAGLE 2 inlet fitting.

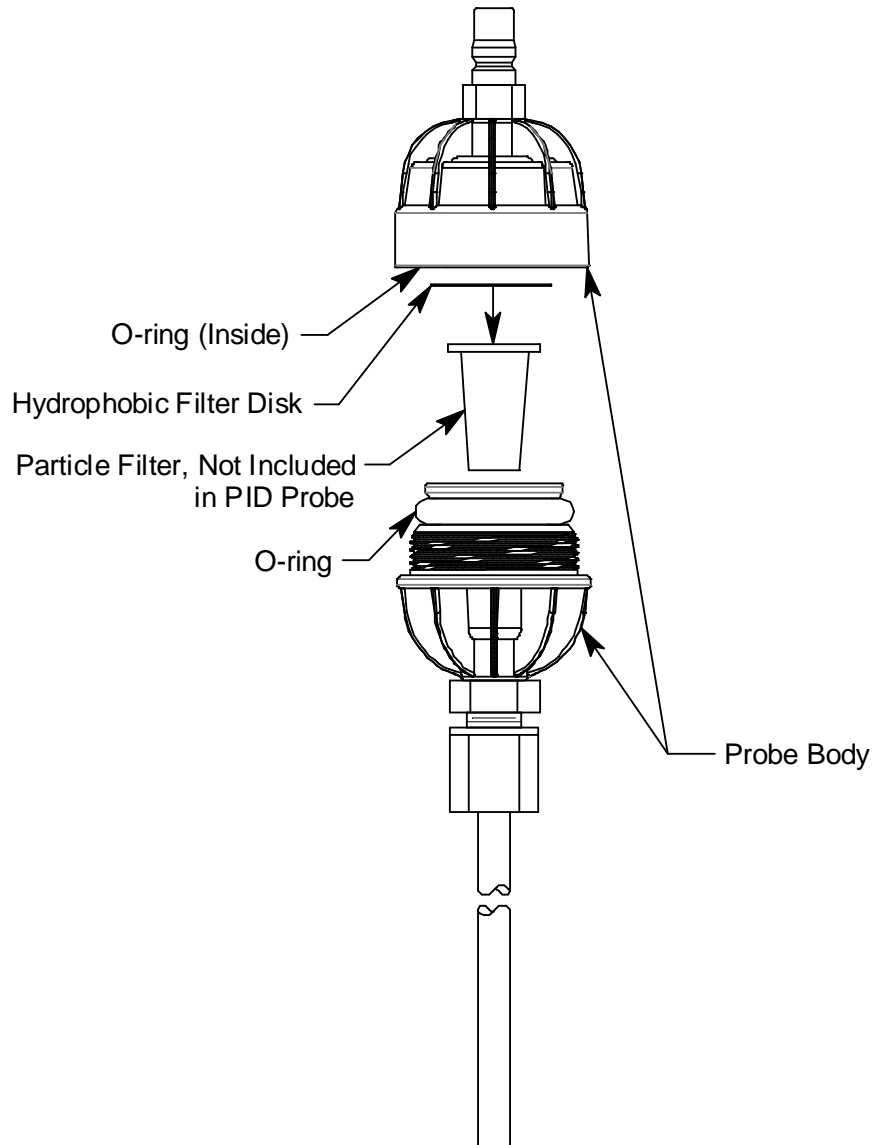

**Figure 21: Replacing the Particle Filter and Hydrophobic Filter Disk**

2. Remove the white hydrophobic filter disk from the top of the particle filter or from the probe body.
3. Remove the particle filter from the probe body.

4. Clean the inside of the probe body if necessary.
5. Hold the probe half that has the plastic tube fitting and the probe tube with the fitting and tube facing down.
6. Place the new cone-shaped particle filter into the probe body so that the wide part of the filter is facing up.

**NOTE:** Do not install the particle filter into a probe intended to be used with a PID EAGLE 2.

7. Place the new filter disk flat on top of the particle filter. Make sure it is centered over the particle filter.
8. Carefully screw the other half of the probe body onto the half with the particle filter and filter disk while keeping the probe oriented vertically to keep the disk centered.
9. When you feel the O-ring being compressed, grasp both ends of the probe and tighten them together very firmly to ensure a seal.
10. To test the seal, do the following.
  - install the probe on the EAGLE 2
  - startup the EAGLE 2
  - confirm that a low flow alarm occurs when you cover the end of the probe tube with your finger
  - if a low flow alarm does not occur, hand tighten the probe further
  - if a low flow alarm still does not occur when you cover the probe tube with your finger, disassemble the probe, inspect the placement of the O-rings and filter disk, reassemble the probe, and re-test it.

---

## Replacing the Hydrophobic Filter

Replace the hydrophobic filter inside the bottom case when it becomes dirty or clogged. An unexplained low flow alarm may indicate that the hydrophobic filter is dirty and needs to be replaced.

1. Verify that the EAGLE 2 is off.
2. Place the EAGLE 2 upside down on a flat surface or hold it upside down.
3. Unscrew the three case screws until they disengage from the top case. They are captive screws so they will not fall off of the bottom case.
4. Turn the EAGLE 2 right side up and carefully lift the top case away from the bottom case. Be careful not to lift it so far that it pulls on the main PCB with the cable that connects the top case to the main PCB.
5. Lay the top case down next to the bottom case to allow access to the flow system.

6. Locate the hydrophobic filter. It is over the oxygen sensor. Note which side of the hydrophobic filter has the RKI logo and part number. This is the inlet side and should be facing toward the front of the EAGLE 2.

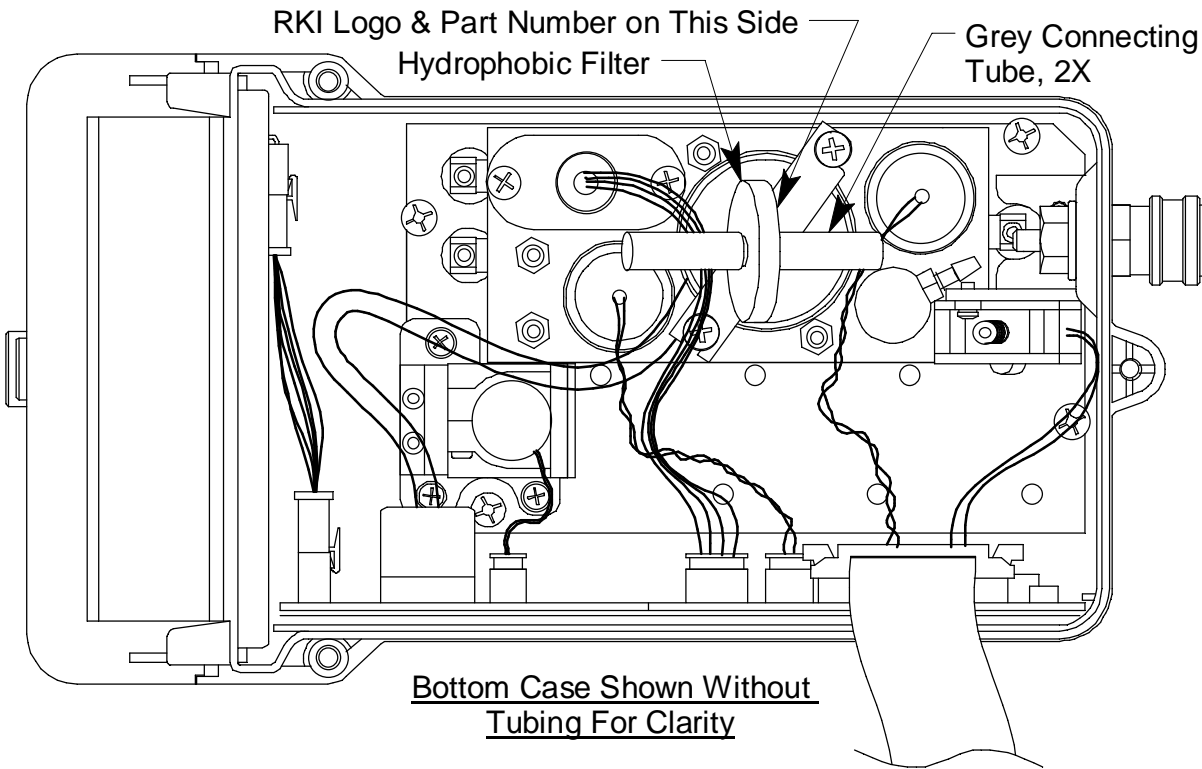
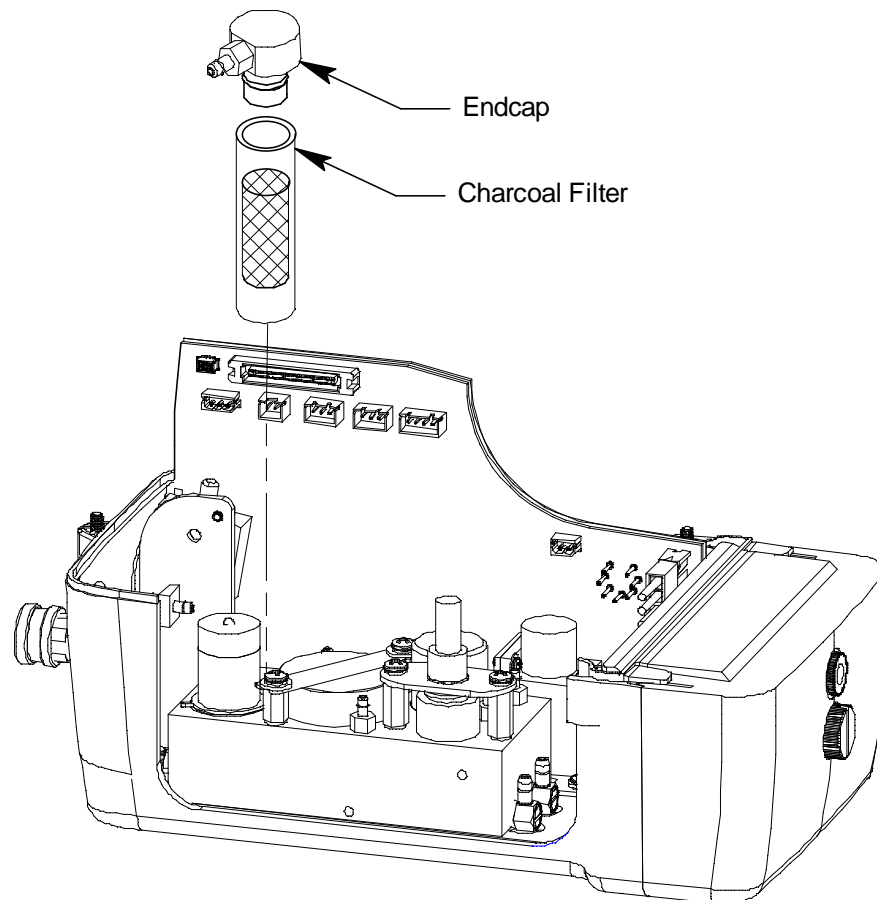

**Figure 22: Replacing the Hydrophobic Filter**

7. Pull the grey connecting tubes off of each end of the filter and remove it.
8. Install the new filter with the red RKI logo and part number on the inlet side of the flow chamber, facing the front of the EAGLE 2. Make sure to push the grey connection tubes all the way onto the filter's hose barbs.
9. Confirm that the main PCB is seated in its slots and that its bottom edge is resting on the bottom of the bottom case. If the main PCB is not seated properly, then it may be damaged when the top case is re-installed.
10. Make sure that the top case gasket is fully seated in its groove and carefully put the top case back on the bottom case. If you have any difficulty mating the top and bottom cases, inspect the placement of the main PCB and the placement of the top case gasket.
11. Turn the EAGLE 2 upside down and tighten the three case screws to secure the top case to the bottom case.

## Replacing the Charcoal Filter

1. Verify that the EAGLE 2 is off.
2. Place the EAGLE 2 upside down on a flat surface or hold it upside down.
3. Unscrew the three case screws until they disengage from the top case. They are captive screws so they will not fall off of the bottom case.
4. Turn the EAGLE 2 right side up and carefully lift the top case away from the bottom case. Be careful not to lift it so far that it pulls on the main PCB with the cable that connects the top case to the main PCB.
5. Lay the top case down next to the bottom case to allow access to the flow system.
6. Locate the charcoal filter. It is next to the CO sensor at the front of the flow chamber.



**Figure 23: Replacing the Charcoal Filter**

7. Grasp the black charcoal filter endcap and pull it off of the charcoal filter.
8. Grasp the top of the charcoal filter firmly and pull it out of the flow chamber. Insert the replacement charcoal filter into the filter position in the flow chamber and push it in until it bottoms out.
9. Insert the charcoal filter endcap into the end of the charcoal filter and push it in until it bottoms out.
10. Confirm that the main PCB is seated in its slots and that its bottom edge is resting on the bottom of the bottom case. If the main PCB is not seated properly, then it may be damaged when the top case is re-installed.

11. Make sure that the top case gasket is fully seated in its groove and carefully put the top case back on the bottom case. If you have any difficulty mating the top and bottom cases, inspect the placement of the main PCB and the placement of the top case gasket.
12. Turn the EAGLE 2 upside down and tighten the three case screws to secure the top case to the bottom case.

---

## Checking the Combustible Gas Sensor's Condition

If you suspect that the combustible sensor has been contaminated or may be reaching the end of its operational life, do the following to confirm it is still operating properly:

1. Perform a calibration using single calibration as described in “Calibrating Using the Single Calibration Method” on page 62.
2. When you perform the span adjustment, note the adjustment range on the result screen as described in Step 12 and Step on page 65.
3. A new sensor can typically be adjusted to more than twice the calibration gas concentration. If the result screen indicates that the EAGLE 2 could not adjust the combustible gas reading to be at least 10% higher than the calibration gas concentration, then the sensor should be replaced as soon as possible.

---

## Replacing a Sensor

1. Verify that the EAGLE 2 is off.
2. Place the EAGLE 2 upside down on a flat surface or hold it upside down.
3. Unscrew the three case screws until they disengage from the top case. They are captive screws so they will not fall off of the bottom case.
4. Turn the EAGLE 2 right side up and carefully lift the top case away from the bottom case. Be careful not to lift it so far that it pulls on the main PCB with the cable that connects the top case to the main PCB.
5. Lay the top case down next to the bottom case to allow access to the flow system.

6. Locate the sensor you want to replace and remove it from the flow chamber.

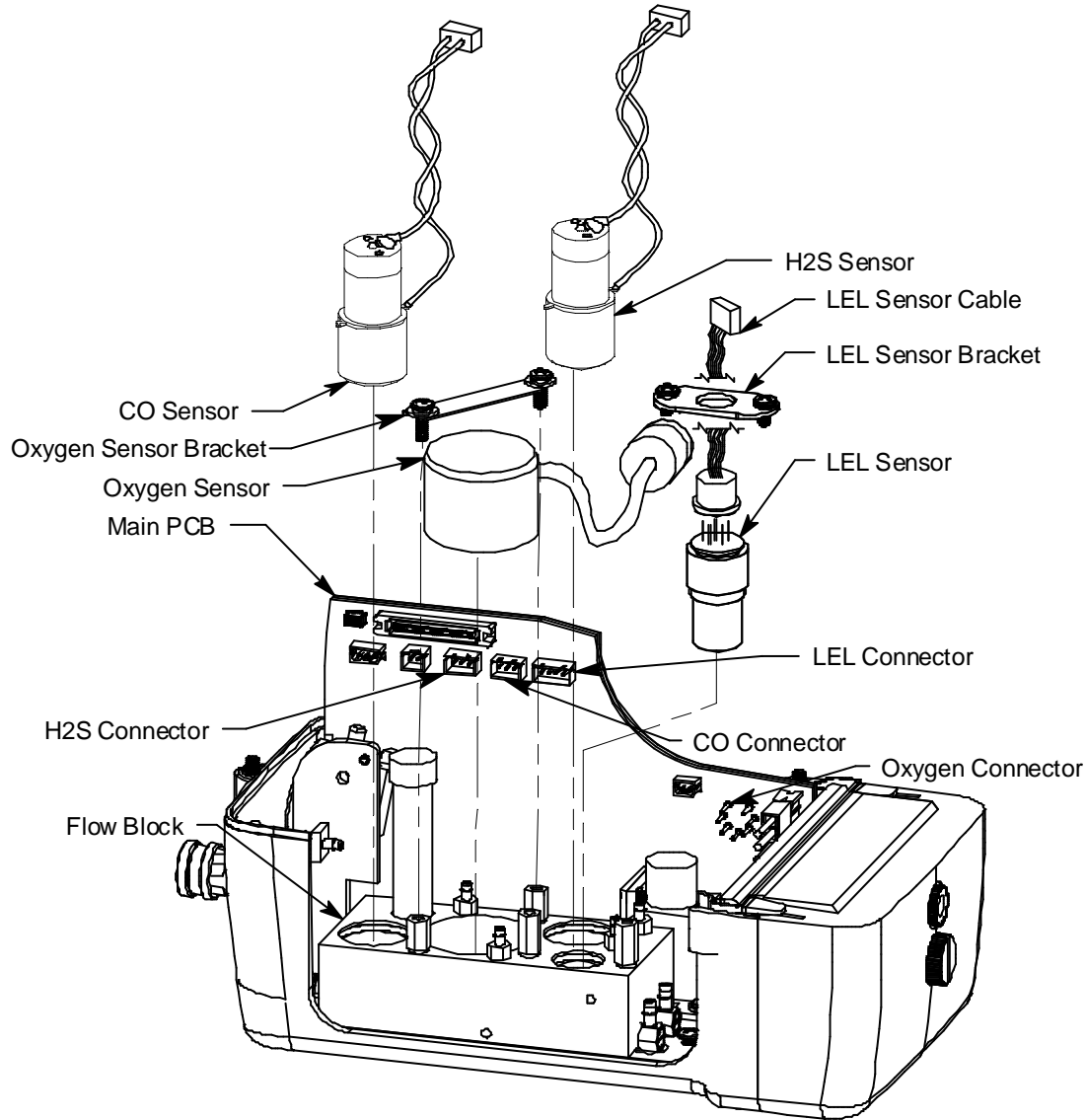

**Figure 24: Replacing a Sensor**

7. To remove the LEL sensor, do the following:
  - Unscrew and remove the two screws that hold down the LEL sensor bracket.
  - Grasp the LEL sensor connector and gently pull it up until it either disengages from the LEL sensor or the LEL sensor comes out of the flow chamber with the connector.
  - If the sensor came out with the connector, remove the sensor from the connector.
  - If the sensor stayed in the flow chamber, grasp the sensor and pull it out of the flow chamber.
8. To remove the oxygen sensor, do the following:
  - Unscrew the two screws that hold the oxygen sensor bracket a few turns so that you can rotate and remove the oxygen sensor bracket. Make sure to note the routing of the oxygen sensor cable to the main PCB so that you can route the replacement sensor cable the same way. Also make sure that the O-ring in the bottom of the flow chamber does not come out with the sensor.

- Move the hydrophobic filter towards the bottom case side wall and pull the oxygen sensor out of the flow chamber.
  - Hold the main PCB to support it where the oxygen sensor cable connects to it.
  - Grasp the connector on the end of the sensor cable and pull the connector away from the main PCB to disconnect it from the main PCB.
9. To remove the H<sub>2</sub>S and CO sensors, do the following:
- Grasp the sensor firmly and rock it back and forth slightly while pulling on it. Make sure to note the routing of the sensor cable to the main PCB so that you can route the replacement sensor cable the same way.
  - If the sensor does not come out of the flow chamber easily enough using this method, grasp it with a pair of pliers and rock it back and forth slightly while pulling on it.

**CAUTION:** *If using pliers to remove a sensor, be careful not to damage the sensor in case you find that the sensor is still functional and does not need to be replaced.*

- Hold the main PCB to support it where the sensor cable connects to it.
  - Grasp the connector on the end of the sensor cable and pull the connector away from the main PCB to disconnect it from the main PCB.
10. Install the new sensor.
11. To install the LEL sensor, do the following:
- Plug the replacement sensor into the sensor connector on the LEL sensor cable.
  - Insert the LEL sensor into the LEL sensor chamber in the flow chamber.
  - Line up the holes in the LEL sensor bracket with the two standoffs on either side of the LEL sensor chamber.
  - Install the two sensor bracket screws tightening them a little at a time alternately to push the sensor into its chamber evenly.
12. To install the oxygen sensor, do the following:
- Confirm that the sealing O-ring is still in the bottom of the oxygen sensor chamber in the flow chamber and insert the oxygen sensor face down into the chamber.
  - Route the sensor cable the same way the old sensor cable was routed and connect it to the main PCB. Make sure to support the main PCB when making the connection.
  - Reinstall the oxygen sensor bracket and tighten both bracket screws firmly.
13. To install the H<sub>2</sub>S and CO sensors, do the following:
- Insert the sensor face down into the sensor chamber in the flow chamber.
  - Push the sensor in until it bottoms out.
  - Route the sensor cable the same way the old sensor cable was routed and connect it to the main PCB. Make sure to support the main PCB when making the connection.

14. Confirm that the main PCB is seated in its slots and that its bottom edge is resting on the bottom of the bottom case. If the main PCB is not seated properly, then it may be damaged when the top case is re-installed.
15. Make sure that the top case gasket is fully seated in its groove and carefully put the top case back on the bottom case. If you have any difficulty mating the top and bottom cases, inspect the placement of the main PCB and the placement of the top case gasket.
16. Turn the EAGLE 2 upside down and tighten the three case screws to secure the top case to the bottom case.
17. Calibrate the new sensors as described in “Chapter 4: Calibration Mode” on page 54.

---

## General Parts List

Table 11 lists part numbers for the EAGLE 2’s replacement parts and accessories.

**Table 11: General Parts List**

Part Number	Description
06-1248RK-03	Calibration kit tubing, 3 foot length
07-7210RK	O-ring for inlet fitting half of probe
07-7304RK	O-ring for tube half of probe
13-1061RK	Panel screw, captive, 6-32 x 1/2 inch, for bottom case
13-1081RK	Thumbscrew, captive, 10-32 x 2 inches, for battery case
30-0600RK-01	Pump
33-0156RK-01	Filter element, hydrophobic disk, for standard 80-0131RK-10 probe, pack of 5
33-0173RK	Internal hydrophobic filter
33-1200RK	Particle filter for standard 80-0131RK-10 probe
33-2002RK-01	Humidifier, 24 inch, for calibration of catalytic combustible channel with gas concentrations of 1000 ppm or lower
33-6090RK	Charcoal filter
35-0110RK	Dummy sensor, CO or H <sub>2</sub> S sensor position
35-0111RK	Dummy sensor, oxygen sensor position
35-0112RK	Dummy sensor, LEL sensor position
47-1016RK	Vehicle plug 12 VDC adapter cable for charger
47-5010RK	TC/LEL sensor cable
47-5084RK	USB/IrDA adapter module, Legasic, for use with all premier portables (without USB cable)

**Table 11: General Parts List (cont.)**

<b>Part Number</b>	<b>Description</b>
47-5084RK-01	USB/IrDA adapter assembly, Legasic, for use with all premier portables (with module and USB cable)
47-5085RK	Cable, USB A to USB mini, 6 feet, for USB/IrDA adapter module
49-0115RK	AC adapter
49-1130RK	C size alkaline battery
49-1330RK	C size Ni-MH battery
49-2174RK	Charging module
49-2175RK	115/220 VAC charger
49-2176RK	12 VDC charger
49-2177RK	115/220 VAC and 12 VDC charger
61-0155RK	LEL combustible sensor, catalytic, hydrogen specific, no shrink tubing (for H <sub>2</sub> specific units sold before 3/6/2019)
61-0155-01	LEL combustible sensor, catalytic, hydrogen specific, with shrink tubing (for H <sub>2</sub> specific units sold after 3/6/2019)
65-0601RK	Oxygen sensor
65-2005RK	Carbon monoxide (CO) sensor
71-0154RK	Operator's Manual, EAGLE 2 (this document)
71-0170RK	Operator's Manual, Eagle 2 Data Logger Management Program
71-8003RK	EAGLE 2 Product CD, includes Data Management Program, User Setup Program, and all operator's manuals
80-0131RK-10	10 inch hydrophobic probe (standard probe)
80-0133RK-10	30 inch aluminum probe
80-0134RK-10	4 foot stainless steel hydrophobic probe
80-0135RK-10	30 inch stainless steel hydrophobic probe
80-0136RK	32 inch telescoping fiberglass probe w/dust filter
80-0137RK	10 inch probe w/dust filter
80-0143RK	7 foot telescoping fiberglass probe w/dust filter
80-0156RK-10	30 inch fiberglass hydrophobic probe
80-0160RK-12	12 foot extendable probe
80-0160RK-18	18 foot extendable probe
80-0405RK	Dilution fitting, 1:1

**Table 11: General Parts List (cont.)**

<b>Part Number</b>	<b>Description</b>
80-0406RK	Dilution fitting, 3:1
80-05XXRK	Sample hose. Replace "XX" with length in feet. 5 foot hose is standard. Available lengths for the EAGLE 2 are 3, 4, 5, 6, 10, 15, 20, 25, 30, 35, 40, 50, 75, 100, and 125 feet.
81-0090RK-01	Calibration cylinder, 34 liter steel, three-gas (CH <sub>4</sub> /O <sub>2</sub> /CO)
81-0090RK-03	Calibration cylinder, 103 liter, three-gas (CH <sub>4</sub> /O <sub>2</sub> /CO)
81-0154RK-02	Calibration cylinder, 58 liter; four-gas (CH <sub>4</sub> /O <sub>2</sub> / H <sub>2</sub> S/CO)
81-0154RK-04	Calibration cylinder, 34 liter aluminum; four-gas (CH <sub>4</sub> /O <sub>2</sub> / H <sub>2</sub> S/CO)
81-1054RK	Regulator, demand-flow type, for 34 liter aluminum/58 liter/103 liter calibration cylinders (cylinders with internal threads)
81-1055RK	Regulator, demand-flow type, for 17 liter and 34 liter steel calibration cylinders (cylinders with external threads)
81-5302RK	Calibration kit, for LEL/Oxy/CO unit, w/demand flow regulator, 103 liter cylinder
81-5401RK	Calibration kit, for LEL/Oxy/H <sub>2</sub> S/CO unit, w/demand flow regulator, 58 liter cylinder
ES-87RW-H2S	Hydrogen Sulfide (H <sub>2</sub> S) sensor
NC-6260B	LEL combustible sensor, catalytic

# Appendix A: Calibrating with a Sample Bag

---

## Overview

The EAGLE 2 can be calibrated with a gas bag calibration kit instead of a demand flow regulator kit. This appendix describes how to use a sample bag calibration kit to calibrate the EAGLE 2. A parts list at the end of this appendix lists spare parts for the calibration kit.

---

## Calibration Supplies and Equipment

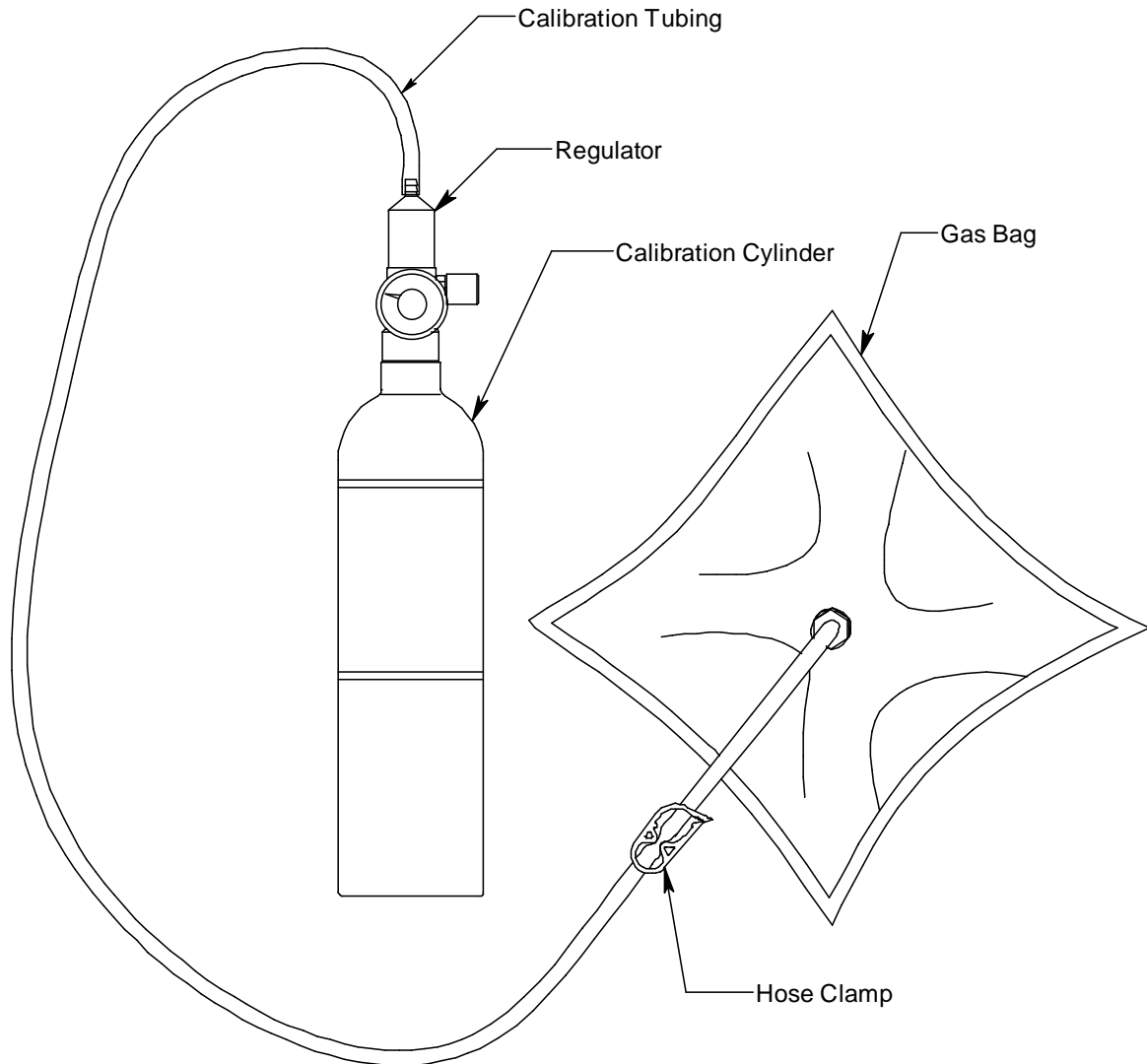

**Figure 25: Gas Bag Calibration Kit**

To calibrate the EAGLE 2, you will need:

- Known calibrating samples of the gases being detected. The combustible and toxic gas samples should have concentrations between 10 and 50% of the full scale value. For example, if you are calibrating the catalytic combustible gas channel, your calibration cylinder should have a combustible gas concentration between 10% LEL and 50% LEL. An oxygen-free source, such as 100% nitrogen is recommended for setting the oxygen zero.

**NOTE:** The catalytic combustible channel can be set up for and calibrated to a number of different combustible gases. See “Configuring the Combustible Gas” on page 101 for instructions. Be sure that you are using an appropriate calibration cylinder for the target gas of the catalytic combustible channel.

**CAUTION:** *When using auto calibration with the standard 4-gas EAGLE 2, although the EAGLE 2 can be calibrated with an oxygen concentration of up to 19.5%, RKI Instruments, Inc. recommends that the multi-gas cylinder have an oxygen concentration in the range of 10% - 16% oxygen.*

- A gas collection bag with hose clamp
- A 6 LPM fixed-flow regulator or a dispensing valve

**WARNING:** ***RKI Instruments, Inc. recommends that you dedicate a regulator for use with chlorine (Cl<sub>2</sub>) gas and that you do not use that dedicated regulator for any other gases, particularly hydrogen sulfide (H<sub>2</sub>S).***

- Calibration tubing

To calibrate the combustible gas, oxygen, CO, and H<sub>2</sub>S sensors at the same time, automatically, with no need for a zero-oxygen source, you can use the auto calibration feature with a 4-gas cylinder. If the H<sub>2</sub>S channel is not active, then a 3-gas cylinder may be used for auto calibration. This document includes instructions for auto calibration with a fixed flow regulator or dispensing valve, a sample bag, and a 4-gas cylinder. This document also includes instructions for calibrating one channel at a time using single calibration.

---

## Entering Calibration Mode

To enter Calibration Mode, do the following:

1. Find a fresh-air environment. This is an environment free of toxic or combustible gases and of normal oxygen content (20.9%).
2. While in Measuring Mode, press and hold the RANGE ▼ SHIFT button, then press the DISPLAY ADJUST NO button and release both buttons.
3. If the unit prompts you for the password, enter it by using the AIR ▲ YES and RANGE ▼ SHIFT buttons to select each password number and then pressing and releasing POWER ENTER RESET to enter the number and move on to the next one.

4. The Calibration Mode Screen displays with the cursor next to **AUTO CALIBRATION**.

```
CALIBRATION MODE
> AUTO CALIBRATION
SINGLE CALIBRATION
PERFORM AIR ADJUST
NORMAL OPERATION
```

**NOTE:** The following screens illustrate a 4-gas EAGLE 2 for detection of CH<sub>4</sub> (%LEL using catalytic sensor), oxygen, H<sub>2</sub>S, and CO. Your EAGLE 2 may display slightly different screens.

---

## Calibrating Using the Auto Calibration Method

This method allows you to calibrate the CH<sub>4</sub> (%LEL catalytic combustible sensor), oxygen, H<sub>2</sub>S, and CO sensors simultaneously. It is designed for use with the RKI 4-gas calibration cylinder and is the quickest and most convenient method to calibrate the EAGLE 2.

### Setting the Fresh Air Reading

1. While in the Calibration Mode Screen, move the cursor to the **PERFORM AIR ADJUST** menu item by using the RANGE ▼ SHIFT button.

```
CALIBRATION MODE

AUTO CALIBRATION
SINGLE CALIBRATION
> PERFORM AIR ADJUST
NORMAL OPERATION
```

2. Press and release the POWER ENTER RESET button. The following screen appears.

```
PERFORM

AIR ADJUST?
```

3. Press and release the AIR ▲ YES button to continue. If you do not want to continue, press the DISPLAY ADJUST NO button and the unit will return to the Calibration Mode Screen.

4. The EAGLE 2 will indicate that it is adjusting the zero reading for a few seconds, then indicate that the operation is complete before returning to the Calibration Mode Screen.

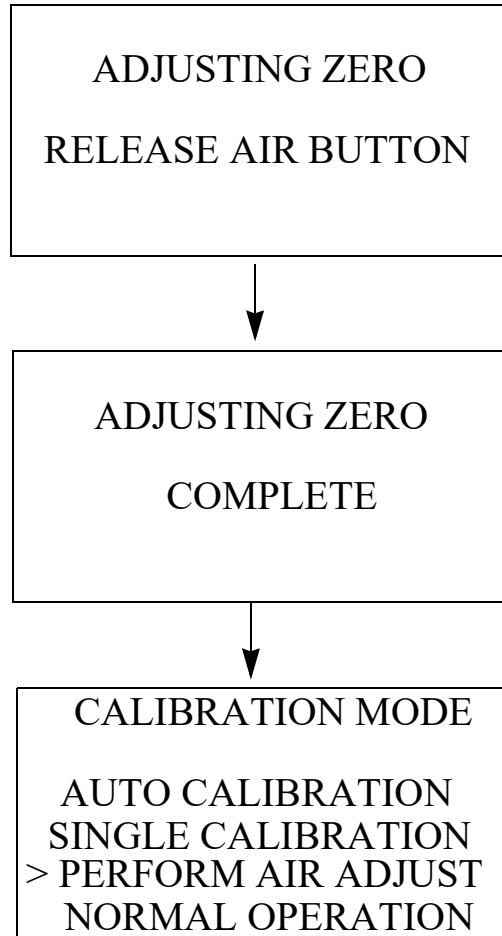

### Performing a Span Adjustment in Auto Calibration

1. Slide the tubing clamp onto the tubing and connect the tubing to the sample bag's inlet fitting. Leave the clamp unclamped for now.
2. Install the probe on the EAGLE 2 inlet fitting. Make sure the probe is complete with internal O-ring and membrane and that the two halves of the probe are tightened firmly together to avoid leaks that can affect the calibration. See Figure 21, "Replacing the Particle Filter and Hydrophobic Filter Disk" on page 72 for an illustration of the internal parts of the probe.
3. Move the cursor next to the **AUTO CALIBRATION** menu item by using the AIR ▲ YES button.

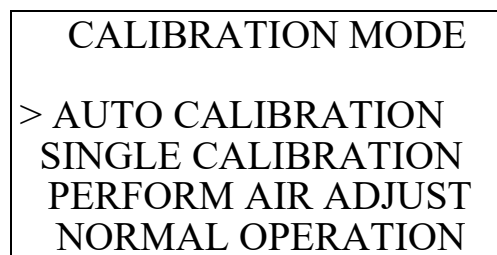

4. Press and release the POWER ENTER RESET button to display the Calibration Gas Values Screen.

CAL GAS VALUES		
CH4	50	%LEL
OXY	12.0	vol%
H2S	25.0	ppm
CO	50	ppm
ENTER TO BEGIN CAL		

The gas concentrations displayed in the Calibration Gas Values Screen must match the gas concentrations listed on the 4-gas calibration cylinder.

If *all* concentrations match, go to Step 15.

If *one or more* concentrations *do not* match, continue with Step 5.

If you do not want to continue with the calibration, press and release the DISPLAY ADJUST NO button to return to the Calibration Mode Screen.

**NOTE:** The RKI 4-gas cylinder typically contains 12% O<sub>2</sub> by volume. When using the auto calibration method, be sure to set the “OXY” auto calibration gas value to agree with the concentration listed on the cylinder’s label, not zero.

5. To adjust the values on the screen, hold down the RANGE ▼SHIFT button, then press the DISPLAY ADJUST NO button and release both. The following screen appears with the cursor next to **CH4**.

ADJUST AUTO CALIBRATION VALUES		
> CH4	50	%LEL
OXY	12.0	vol%
H2S	25.0	ppm
CO	50	ppm ▼

6. Place the cursor next to the channel whose gas value you want to change using the AIR ▲ YES and RANGE ▼SHIFT buttons.
7. Press and release the POWER ENTER RESET button to select the channel. The calibration gas value begins to flash.
8. Use the AIR ▲ YES and RANGE ▼SHIFT buttons to adjust the calibration gas setting to the desired value.

**NOTE:** The calibration gas value cannot be set lower than the low alarm setting. If the calibration gas value listed on the calibration cylinder is lower than the current low alarm setting, enter Setup Mode and change the low alarm setting. See “Updating the Alarm Point Settings” on page 106 for instructions. If you need to change the alarm point setting only to perform a calibration, make sure that you change the alarm point setting back to its original value once the calibration has been performed.

9. Press and release the POWER ENTER RESET button to save the change. The calibration gas value stops flashing.
10. Repeat Step 6 through Step 9 for any other channels that need to be changed.

11. When you are done adjusting the calibration gas values, move the cursor down past the bottom of the screen next to **END**.

```
ADJUST AUTO
CALIBRATION VALUES
> END ▲
```

12. Press and release the POWER ENTER RESET button. The following screen appears.

```
DO YOU WANT TO
STORE NEW VALUE(S)
IN MEMORY FOR
FUTURE CALIBRATIONS?

PRESS YES OR NO
```

13. If you select YES by pressing and releasing the AIR ▲ YES button, the changes that you made will be saved in the EAGLE 2's memory as the new auto calibration gas values.

If you select NO by pressing and releasing the DISPLAY ADJUST NO button, the changes you made will be used for any calibrations performed during the current operating session only. The EAGLE 2 will delete the changes when the unit is turned off and will load the previous set of auto calibration values when it is turned on again.

14. When you make your selection and press the desired button, the unit returns to the Calibration Gas Values Screen.

```
CAL GAS VALUES
CH4  50 %LEL
OXY  12.0 vol%
H2S  25.0 ppm
CO   50 ppm
ENTER TO BEGIN CAL
```

15. Press and release the POWER ENTER RESET button to proceed to the Calibration In Process Screen. **CAL IN PROCESS** is flashing.

```
CAL IN PROCESS
CH4    0 %LEL
OXY  20.9 vol%
H2S   0.0 ppm
CO    0 ppm
ENTER WHEN DONE
```

If you do not want to proceed with the calibration, press and release the DISPLAY ADJUST NO button to return to the Calibration Gas Values Screen.

If you do want to continue with the calibration, proceed to the next step.

16. Connect the gas bag tubing to the regulator's or dispensing valve's hose barb fitting.
17. Fill the gas collection bag by screwing the fixed flow regulator or dispensing valve onto the calibration cylinder and turning the knob counterclockwise.
18. Allow the gas to dispense until the gas collection bag is a little over half full.
19. Turn the knob clockwise to stop the gas flow, clamp down the hose clamp and remove the regulator or dispensing valve from the cylinder.
20. Disconnect the tubing from the regulator or dispensing valve.
21. Open the hose clamp on the gas bag tubing.
22. Connect the tubing from the gas bag to the rigid tube on the probe. Allow the gas to flow for one minute.

**NOTE:** If you are calibrating the catalytic combustible channel with a gas concentration of 1000 ppm or lower, you must use a 24 inch humidifier tube to connect the gas bag to the rigid tube on the probe.

23. Press and release the POWER ENTER RESET button to set the span adjustment to the programmed values.
24. If all channels passed calibration the following screen sequence occurs.

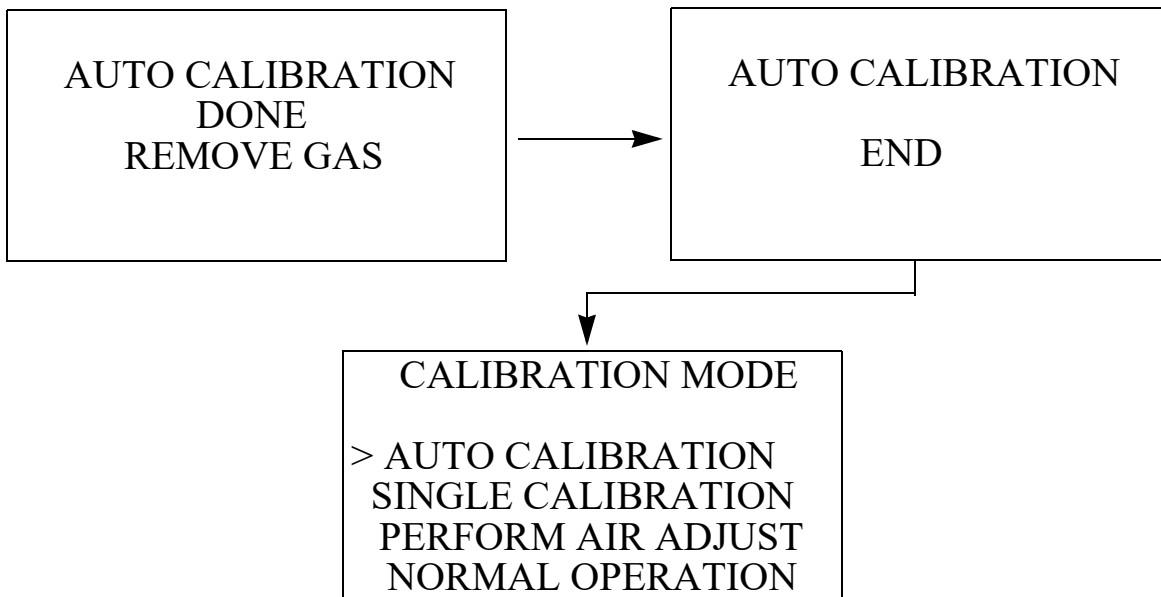

If any of the sensors cannot be adjusted to the proper value, a screen displays that indicates a calibration failure and lists the sensor(s) that failed to calibrate. In the example below, the oxygen and H<sub>2</sub>S channels failed calibration. The other sensors calibrated normally.

FAIL SENSOR

< > <OXY>  
<H2S> < >

ENTER TO CONTINUE

The buzzer and LED arrays activate in a double pulsing pattern. Press and release the POWER ENTER RESET button to reset the alarm and return to the Calibration Mode Screen. Attempt to calibrate again. If the failure continues, investigate the cause. See “Troubleshooting” on page 67.

25. Disconnect the tubing from the probe.
26. Use the RANGE ▼ SHIFT button to place the cursor next to the **NORMAL OPERATION** menu option, then press and release the POWER ENTER RESET button to return to Measuring Mode.

---

## Calibrating Using the Single Calibration Method

Single Calibration allows you to calibrate one channel at a time. This is useful if you only want to calibrate one or two channels.

### Setting the Fresh Air Reading

1. While in the Calibration Mode Screen, move the cursor to the **PERFORM AIR ADJUST** menu item by using the RANGE ▼ SHIFT button.

CALIBRATION MODE

AUTO CALIBRATION  
SINGLE CALIBRATION  
> PERFORM AIR ADJUST  
NORMAL OPERATION

2. Press and release the POWER ENTER RESET button. The following screen appears.

PERFORM  
AIR ADJUST?

3. Press and release the AIR ▲ YES button to continue. If you do not want to continue, press the DISPLAY ADJUST NO button and the unit will return to the Calibration Mode Screen.

4. The EAGLE 2 will indicate that it is adjusting the zero reading for a few seconds, then indicate that the operation is complete before returning to the Calibration Mode Screen.

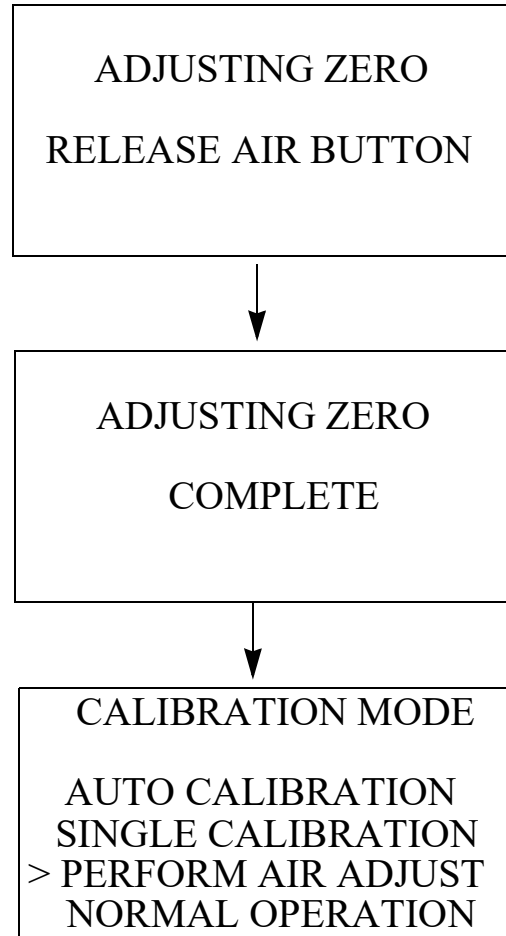

### **Performing a Span Adjustment in Single Calibration**

1. Slide the tubing clamp onto the tubing and connect the tubing to the sample bag's inlet. Leave the clamp unclamped for now.
2. Connect the other end of the tubing to the regulator's or dispensing valve's hose barb fitting.
3. Install the probe on the EAGLE 2 inlet fitting. Make sure the probe is complete with internal O-ring and membrane and that the two halves of the probe are tightened firmly together to avoid leaks that can affect the calibration. See Figure 21, "Replacing the Particle Filter and Hydrophobic Filter Disk" on page 72 for an illustration of the internal parts of the probe.

4. Move the cursor next to the **SINGLE CALIBRATION** menu item by using the AIR ▲ YES button.

```
CALIBRATION MODE  
  
AUTO CALIBRATION  
> SINGLE CALIBRATION  
PERFORM AIR ADJUST  
NORMAL OPERATION
```

5. Press and release the POWER ENTER RESET button. The Select Sensor Screen appears with the cursor flashing.

```
SELECT SENSOR  
TO CALIBRATE  
  >ESCAPE  
CH4  OXY  
H2S  CO
```

6. Move the cursor next to the sensor you want to calibrate with the AIR ▲ YES and RANGE ▼ SHIFT buttons. In the example below, the CH<sub>4</sub> sensor is selected for span adjustment.

```
SELECT SENSOR  
TO CALIBRATE  
  ESCAPE  
>CH4  OXY  
H2S  CO
```

If you do not want to proceed with the span adjustment, press and release the DISPLAY ADJUST NO button or place the cursor next to **ESCAPE** and press and release POWER ENTER RESET to return to the Calibration Mode Screen.

If you do want to continue with the calibration, proceed with the next step.

7. Press and release the POWER ENTER RESET button to proceed to the Single Calibration Gas Value Screen for the selected channel. The calibration gas value is flashing.

```
SINGLE CALIBRATION  
  
CH4  50 %LEL  
UP/DOWN TO ADJUST  
CALIBRATION VALUE  
ENTER WHEN DONE
```

8. If necessary, adjust the calibration gas value to match the cylinder concentration using the AIR ▲ YES and RANGE ▼ SHIFT buttons. For this example, the calibration gas value is entered as 50 %LEL.

**NOTE:** The calibration gas value cannot be set lower than the low alarm setting. If the calibration gas value listed on the calibration cylinder is lower than the current low alarm setting, enter Setup Mode and change the low alarm setting. See “Updating the Alarm Point Settings” on page 106 for instructions. If you need to change the alarm point setting only to perform a calibration, make sure that you change the alarm point setting back to its original value once the calibration has been performed.

9. Press and release the POWER ENTER RESET button to proceed to the Single Calibration Apply Gas Screen. **CAL IN PROCESS** is flashing.

SINGLE CALIBRATION APPLY GAS CH4 0 %LEL  CAL IN PROCESS ENTER WHEN DONE
--

10. Fill the gas collection bag by screwing the fixed flow regulator or dispensing valve onto the calibration cylinder and turning the knob counterclockwise.
11. Allow the gas to dispense until the gas collection bag is a little over half full.
12. Turn the knob clockwise to stop the gas flow, clamp down the hose clamp and remove the regulator or dispensing valve from the cylinder.
13. Disconnect the tubing from the regulator or dispensing valve.
14. Open the hose clamp on the gas bag tubing.
15. Connect the tubing from the gas bag to the rigid tube on the probe. Allow the gas to flow for one minute.

**NOTE:** If you are calibrating the catalytic combustible channel with a gas concentration of 1000 ppm or lower, you must use a 24 inch humidifier tube to connect the gas bag to the rigid tube on the probe.

16. Press and release the POWER ENTER RESET button to make the span adjustment.
17. When the span adjustment is made, the EAGLE 2 calculates the range of adjustment, minimum and maximum, it could have made based on its response level to the applied gas. This calculated range is independent of the calibration gas value that was entered in Step 8 and Step 9 above. The adjustment range is included on the result screen to indicate the condition of the sensor. If the calibration gas value is in the adjustment range, the span adjustment will pass. If the calibration gas value is out of the adjustment range, the span adjustment will fail.

18. If the span adjustment is successful, the following screens display.

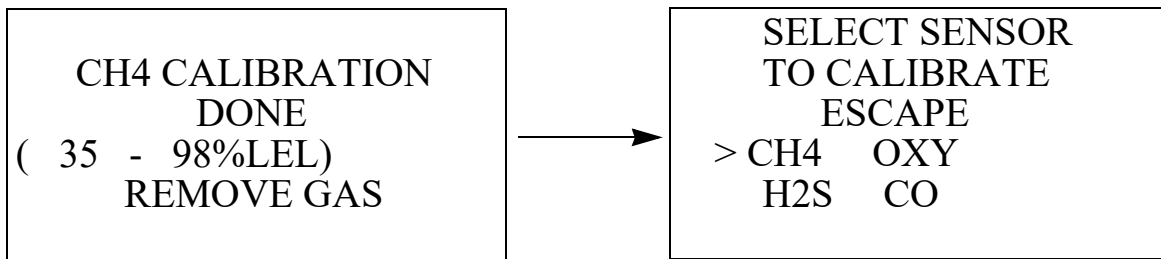

In the example above, the EAGLE 2 could have adjusted the reading as low as 35 %LEL and as high as 98 %LEL.

If the span adjustment is not successful, a screen displays that indicates a calibration failure.

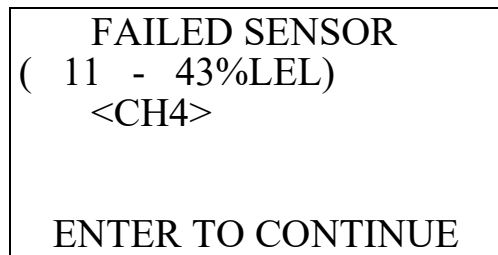

In the example above, the EAGLE 2 could have adjusted the reading as low as 11 %LEL and as high as 43 %LEL. Since the calibration gas value entered was 50 %LEL, the unit failed the span adjustment. The buzzer and alarm LED arrays activate in a double pulsing pattern. Press and release the POWER ENTER RESET button to reset the alarm and return to the Select Sensor Screen. Attempt to calibrate again. If the failure continues, investigate the cause. See “Troubleshooting” on page 67.

**NOTE:** The adjustment range will only appear in the calibration results screen if the Span Factor item in Setup Mode is set to ON. If the Span Factor is set to OFF, the adjustment range will not appear.

19. Disconnect the tubing from the EAGLE 2’s probe.

20. Repeat Step 6 through Step 19 for any other channels you want to calibrate. Make sure you use an appropriate calibration cylinder for each channel.

**CAUTION:** *When calibrating the oxygen channel, verify the concentration of oxygen listed on the cylinder’s label. For oxygen-free samples (100% nitrogen for example), set the oxygen zero setting to 0.0%.*

21. After the last channel is calibrated, disconnect the calibration tubing from the probe.

22. With the Select Sensor Screen displayed, place the cursor next to **ESCAPE** using the AIR ▲ YES button.

<p style="text-align: center;"> <b>SELECT SENSOR TO CALIBRATE &gt;ESCAPE</b>  <b>CH4 OXY</b>  <b>H2S CO</b> </p>
--

23. Press and release the POWER ENTER RESET button to return to the Calibration Mode Screen.
24. Use the RANGE ▼ SHIFT button to place the cursor next to the **NORMAL OPERATION** menu item, then press and release the POWER ENTER RESET button to return to Measuring Mode.

## Parts List

**Table 12: Sample Bag Calibration Kit Spare Parts**

Part Number	Description
06-1248RK-03	Calibration kit tubing, 3 foot length
81-0090RK-01	Calibration cylinder, 3-gas mix, LEL/Oxygen/CO, 34 liter steel
81-0154RK-04	Calibration cylinder, 4-gas mix, LEL/Oxygen/CO/H <sub>2</sub> S, 34 liter aluminum
81-1001RK	Dispensing valve, for 17/34 liter steel cylinders (cylinders with external threads)
81-1051RK-60	Regulator with gauge and knob, 6 LPM, for 34 liter aluminum/58 liter/103 liter cylinders (cylinders with internal threads)
81-1126RK	Gas bag with clamp and hose barb, 9" x 9", 2 liter
81-5302RK-LV	Calibration kit, for LEL/Oxy/CO unit, w/gas bag, 34 Liter
81-5401RK-LV	Calibration kit, for LEL/Oxy/H <sub>2</sub> S/CO unit, w/gas bag, 34 Liter

# Appendix B: Setup Mode

---

## Overview

This appendix describes the EAGLE 2 in Setup Mode. In Setup Mode, you can:

- set the date and time
- set the date format
- set the battery type
- configure the channels
- configure the gas for a catalytic or PID channel
- set the detection units for the catalytic channel
- turn the catalytic sensor relative response feature on or off
- set the alarm points
- change the alarm latching setting
- turn the alarm silence feature on or off
- turn the user/station ID function on or off
- set the auto calibration values
- set the backlight delay time
- turn the automatic fresh air adjust feature on or off
- set the data logging interval time
- turn the data logger overwrite feature on or off
- turn the data log memory clear feature on or off
- adjust the display contrast
- turn the calibration reminder feature on or off
- set the calibration past due action
- set the calibration interval
- select the leak check/bar hole mode operation setting
- set the bar hole measurement time
- turn the zero follower on or off for each channel
- set the zero suppression level for each channel (except oxygen)
- turn the confirmation alert feature on or off
- turn the password feature on or off and set the password
- reset the instrument parameters to their default settings
- turn the lunch break function on or off
- turn the span factor on or off
- select the language
- return to normal operation

The EAGLE 2 is factory-set to suit most applications. Update settings in Setup Mode only if required for your specific application. The description of each item below indicates the factory setting for each item.

---

## Tips for Using Setup Mode

- When in the main menu, the cursor (>) flashes in front of a menu item indicating that the item is selected.
- Use the RANGE ▼ SHIFT button to move the cursor down through the main menu and submenu items, and to lower values or change the setting in a specific option.
- Use the AIR ▲ YES button to move the cursor up through the main menu and submenu items, and to raise values or change the setting in a specific option.
- A down arrow in the lower right corner or an up arrow in the upper right corner of the LCD indicates that additional menu items can be viewed by pressing and releasing the RANGE ▼ SHIFT button in the case of the down arrow or the AIR ▲ YES button in the case of the up arrow. The example below illustrates a down arrow in the lower right corner.

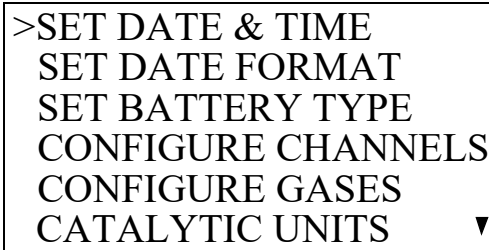

>SET DATE & TIME  
SET DATE FORMAT  
SET BATTERY TYPE  
CONFIGURE CHANNELS  
CONFIGURE GASES  
CATALYTIC UNITS ▼

- Use the POWER ENTER RESET button to enter a selected menu item with the cursor next to it and to enter and save settings during programming.
- An adjustable parameter that is flashing can be adjusted with the AIR ▲ YES and RANGE ▼ SHIFT buttons.
- Press the DISPLAY ADJUST NO button while in a screen where you are entering or updating parameters to exit the screen without saving any changes.

---

## Using Setup Mode

**WARNING:** *The EAGLE 2 is not in operation as a gas detector while in Setup Mode.*

1. Take the EAGLE 2 to a non-hazardous location and turn it off if it is on.
2. Press and hold the AIR ▲ YES and RANGE ▼ SHIFT buttons, then press and hold the POWER ENTER RESET button. When you hear a beep, release the buttons.

3. The LCD will show the following screen for a few seconds with the “S” in the lower right corner indicating the unit is entering Setup Mode.



4. The “S” will then disappear and the following screen will appear for a few seconds.



5. If the unit prompts you for the password, enter it by using the AIR ▲ YES and RANGE ▼ SHIFT buttons to select each password number and then pressing and releasing the POWER ENTER RESET button to enter it and move on to the next number until all of the numbers are entered. The main menu displays. It displays six menu items at a time.

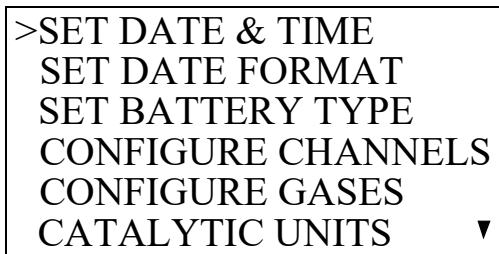

6. Use the AIR ▲ YES or RANGE ▼ SHIFT button to move the cursor up and down the menu items and to view additional menu items. A down arrow in the lower right corner of the LCD or an up arrow in the upper right corner of the LCD indicates that there are additional menu items accessible by moving the cursor down past the last menu item on the LCD or up past the first menu item on the LCD.

## Setting the Date and Time

1. From the main menu, place the cursor next to **SET DATE & TIME**.
2. Press and release POWER ENTER RESET. The date and time will be displayed with the last two digits of the year flashing.

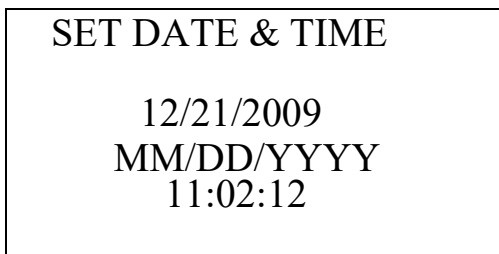

3. Use AIR ▲ YES or RANGE ▼ SHIFT to display the desired year.
4. Press and release POWER ENTER RESET to save the setting. The month setting flashes.
5. Repeat Step 3 and Step 4 to enter the month, day, hours, minutes, and seconds settings. The main menu displays after you enter the seconds setting.

## Setting the Date Format

The date can be displayed in two ways, month/day/year (factory setting) or day/month/year.

1. From the main menu, place the cursor next to **SET DATE FORMAT**.
2. Press and release POWER ENTER RESET. The Set Date Format screen appears with the current setting flashing.

SET DATE FORMAT

UP/DOWN THEN ENTER

MM/DD/YYYY

3. Use AIR ▲ YES or RANGE ▼ SHIFT to display the desired setting.
4. Press and release POWER ENTER RESET to save the setting and return to the main menu.

## Setting the Battery Type

This menu item allows you to select between alkaline and Ni-MH batteries. Since the discharge characteristics of alkaline and Ni-MH batteries are different, the EAGLE 2 uses this setting to ensure that the low battery *warning* is in effect long enough before a dead battery *alarm* to allow the user to change the batteries without a dead battery alarm occurring. This setting has no effect on battery charging.

1. From the main menu, place the cursor next to **SET BATTERY TYPE**.
2. Press and release POWER ENTER RESET. The Battery Type screen appears with the current setting flashing.

BATTERY TYPE

UP/DOWN THEN ENTER

ALKALINE

3. Use AIR ▲ YES or RANGE ▼ SHIFT to display the desired setting.
4. Press and release POWER ENTER RESET to save the setting and return to the main menu.

## Configuring the Channels

This menu item allows you to set the channel type for each of the six channels or to turn one or more channels off. Although the standard EAGLE 2 is factory configured for four channels, combustible gas (catalytic sensor), oxygen, H<sub>2</sub>S, and CO, with channels 5 and 6 turned off, the EAGLE 2 can be factory and field configured for a variety of active channels and detector types. It is not normally necessary to change the factory channel configuration.

**CAUTION:** *Before changing the channel configuration, confirm that the correct sensors and electronic hardware are installed in the EAGLE 2 and that its construction and flow system are appropriate for the installed sensors. Operation of the EAGLE 2 with a flow system or construction not compatible with the installed sensors will result in inaccurate readings. Consult RKI Instruments, Inc. if you cannot confirm either of these items.*

1. From the main menu, place the cursor next to **CONFIGURE CHANNELS**.
2. Press and release POWER ENTER RESET. The Configure Channels screen appears with the cursor flashing next to **CH1**.

```
CONFIGURE CHANNELS
> CH1: CAT (CH4)
  CH2: OXY (OXY)
  CH3: H2S (H2S)
  CH4: CO (CO)      ▼
```

The standard 4-gas configuration is shown below.

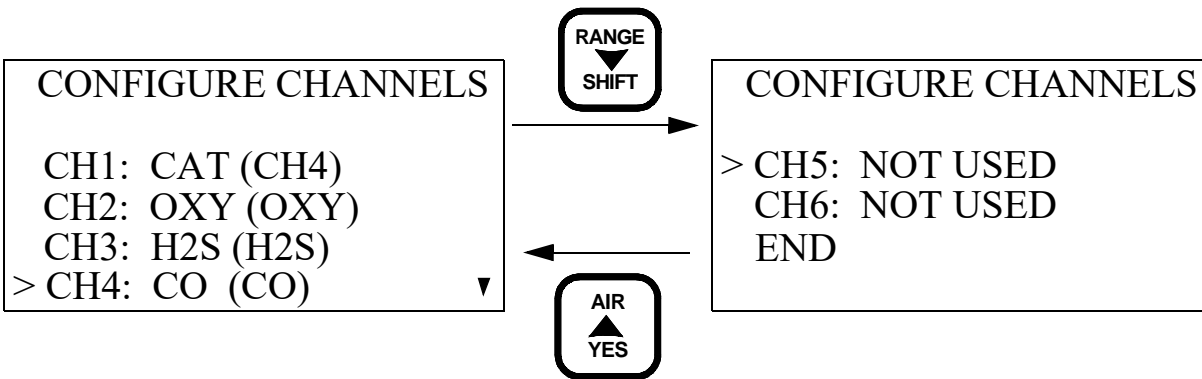

3. Use AIR ▲ YES or RANGE ▼ SHIFT to move the cursor next to the channel you want to configure.

- Press and release POWER ENTER RESET. The available configuration options are shown. In the example below, channel 3 has been selected for configuration.

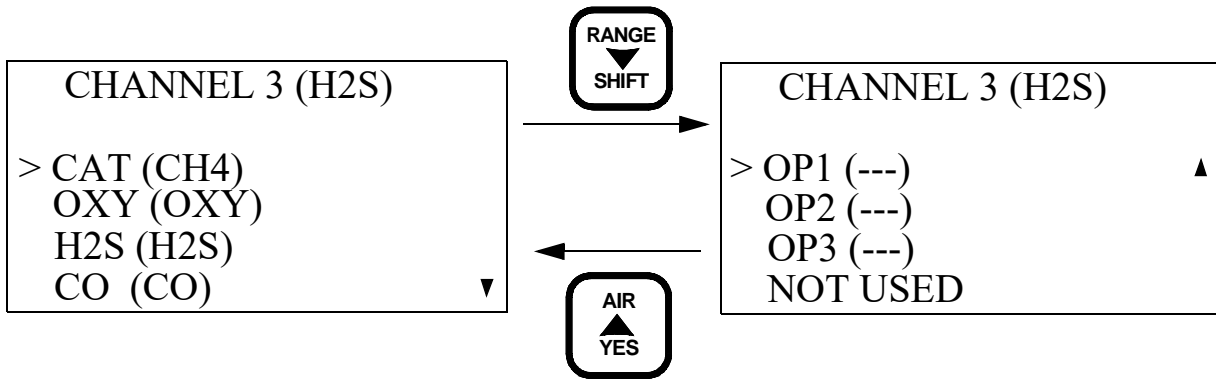

- Use AIR ▲ YES and RANGE ▼ SHIFT to move the cursor next to the desired configuration for the selected channel. In the example below, the cursor has been moved next to the **NOT USED** selection.

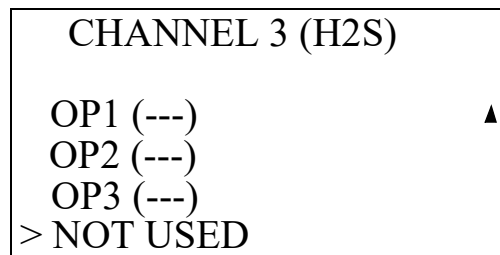

The OP1, OP2, and OP3 options are not defined for a standard 4-gas EAGLE 2. These options are only defined when hardware specific to optional sensors is factory installed in the EAGLE 2. The “---” in the gas name field indicates that hardware necessary to support an optional sensor is not installed. If your EAGLE 2 supports one or more of these optional sensors, the target gas will appear instead of “---”. See “Appendix C: Sub PCBs” on page 121 for a description of this optional hardware and how it affects CHANNEL CONFIGURATION.

- Press and release POWER ENTER RESET to select the channel configuration. In the example below, channel 3 has been turned off by selecting **NOT USED**.

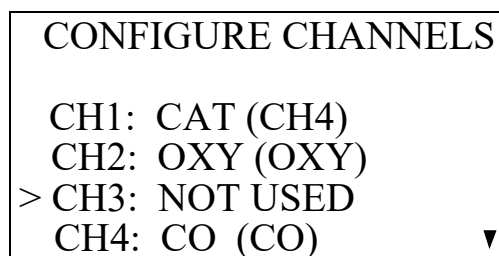

- Repeat Step 5 and Step 6 for any other channels you want to configure.
- Use RANGE ▼ SHIFT to move the cursor next to the **END** menu item.

**NOTE:** If you want to exit to the main menu without saving any channel configuration changes, press and release DISPLAY ADJUST NO.

- Press and release POWER ENTER RESET to save the changes and return to the main menu.

## Configuring the Combustible Gas

This menu item allows you to configure the gas for a catalytic, TC (thermal conductivity), or PID (photo ionization detector) sensor. Only a catalytic sensor is used in a standard EAGLE 2, so only a catalytic sensor can be configured in a standard EAGLE 2. PID or TC sensors can only be configured if additional hardware not in a standard EAGLE 2 is factory installed.

1. From the main menu, place the cursor next to **CONFIGURE GASES**.
2. Press and release **POWER ENTER RESET**. The Configure Gases Screen appears with the cursor flashing next to **CAT**.

```
CONFIGURE GASES
> CAT : CH4 (CAT)
  OP1 : --- (---)
  OP2 : --- (---)
  OP3 : --- (---) ▼
```

The OP1, OP2, and OP3 options are not defined in a standard 4-gas EAGLE 2. These options are only defined when hardware specific to optional sensors is factory installed in the EAGLE 2. See “Appendix C: Sub PCBs” on page 121 for a description of this optional hardware and how it affects **CONFIGURE GASES**.

3. To change the catalytic sensor gas configuration, press and release **POWER ENTER RESET**.
4. A screen appears with gas configuration choices for the catalytic channel.

```
CAT(0-50000ppm CH4)
> 50000 ppm CH4
  11000 ppm HEX
  40000 ppm H2
  18000 ppm IBU ▼
```

For each gas, the LEL (lower explosive limit) and gas name is displayed. The LEL is shown in terms of ppm. The available choices are on two screens.

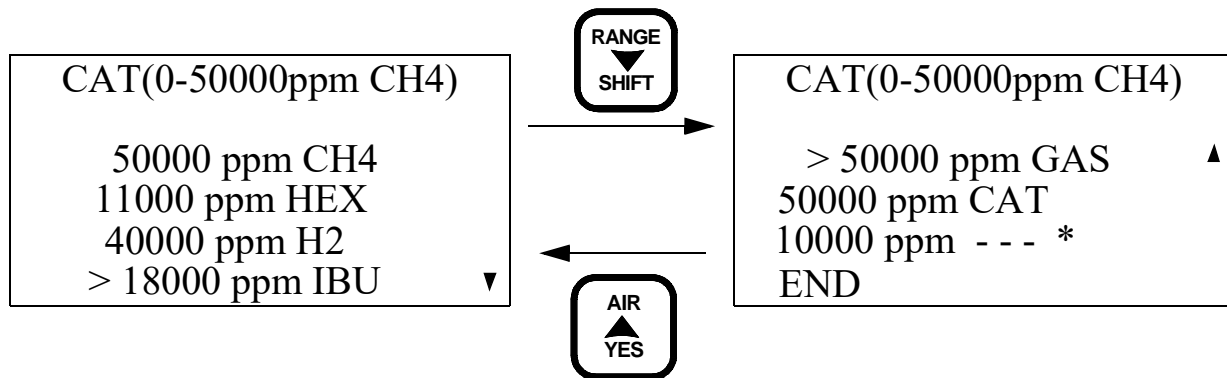

All of the gases except for the one with the asterisk (\*) next to it are pre-defined. The gas with the asterisk next to it is user defined. The user defined gas can be used if the desired gas is not one of the pre-defined gases. Below is a brief description of each choice.

- **50000 ppm CH<sub>4</sub>**  
This selection is for methane (CH<sub>4</sub>) and is the standard factory setting. The LEL for methane is 5 %volume, or 50,000 ppm. If the gas is configured for this choice, the methane elimination feature is inactive and the Methane Elimination Mode Screen will not appear in Display Mode. See “Methane Elimination Mode Screen” on page 44 for a description of the Methane Elimination Mode Screen. See “Appendix J: Methane Elimination Mode” for a description of Methane Elimination Mode.
- **11000 ppm HEX**  
This selection is for hexane. The LEL for hexane is 1.1%, or 11,000 ppm. If the gas is configured for this choice, the methane elimination feature is active and the Methane Elimination Mode Screen is accessible in Display Mode. See “Methane Elimination Mode Screen” on page 44 for a description of the Methane Elimination Mode Screen. See “Appendix J: Methane Elimination Mode” for a description of Methane Elimination Mode.
- **40000 ppm H<sub>2</sub>**  
This selection is for hydrogen (H<sub>2</sub>). The LEL for hydrogen is 4%, or 40,000 ppm. If the gas is configured for this choice, the methane elimination feature is inactive, the Methane Elimination Mode Screen will not appear in Display Mode, and the catalytic sensor voltage is set to 1.1 volts. The standard catalytic sensor voltage is 2.4 volts. Because the detector voltage is set to 1.1 volts, the catalytic sensor will not respond significantly to methane and many other combustible gases, but will respond to hydrogen.

**WARNING:** *Do not configure the catalytic sensor gas to hydrogen if you are monitoring for general hydrocarbons. Only use this selection if you are monitoring exclusively for hydrogen or if you do not want to see a significant response to other combustible gases.*

- **18000 ppm IBU**  
This selection is for isobutane. The LEL for isobutane is 1.8%, or 18,000 ppm. If the gas is configured for this choice, the methane elimination feature is inactive and the Methane Elimination Mode Screen will not appear in Display Mode. See “Methane Elimination Mode Screen” on page 44 for a description of the Methane Elimination Mode Screen. See “Appendix J: Methane Elimination Mode” for a description of Methane Elimination Mode.
- **50000 ppm GAS**  
This selection is for a generic combustible gas with the LEL set to 50000 ppm. If the gas is configured for this choice, the methane elimination feature will be active, but the Methane Elimination Mode Screen will not appear in Display Mode, so methane elimination cannot be turned off. In addition, the relative response feature is inactive even if it is set to ON in the Setup Mode Relative Responses menu item.

**CAUTION:** *The 50000 ppm GAS gas configuration is normally set at the factory for very specific applications. Consult RKI Instruments, Inc. before configuring the gas for 50000 ppm GAS.*

- 50000 ppm CAT

This selection is for users who want their catalytic channel to be configured with the standard factory settings but would like the gas name to be displayed as something other than CH<sub>4</sub> so that it doesn't get confused with other combustible sensors that might be installed (IR, TC). The LEL is set to 50,000 ppm. If the gas is configured for this choice, the methane elimination feature is inactive and the Methane Elimination Mode Screen will not appear in Display Mode. See "Methane Elimination Mode Screen" on page 44 for a description of the Methane Elimination Mode Screen. See "Appendix J: Methane Elimination Mode" for a description of Methane Elimination Mode.

- 10000 ppm - - - \*

This selection is a user defined selection. The factory setting is 10000 ppm - - - \*, with the asterisk (\*) indicating that it is user defined. If this selection has been updated in the field, it will appear differently, but the asterisk will always remain next to the menu item to indicate it is user defined. If you choose the user defined selection, the unit will prompt you to enter four parameters: a three character gas name, the LEL value in terms of ppm, the response factor relative to methane, and the detector voltage. When you configure the gas as the user defined choice, the methane elimination feature is active and the Methane Elimination Mode Screen is accessible in Display Mode. See "Methane Elimination Mode Screen" on page 44 for a description of the Methane Elimination Mode Screen. See "Appendix J: Methane Elimination Mode" for a description of Methane Elimination Mode.

5. Use AIR ▲ YES and RANGE ▼ SHIFT to move the cursor next to the desired gas for the catalytic channel.
6. If you placed the cursor next to one of the pre-defined gases, press and release POWER ENTER RESET to select the gas and proceed to Step 15.

If you placed the cursor next to the user defined gas with the asterisk (\*), press POWER ENTER RESET and proceed with Step 7.

7. The user defined gas setup screen appears with the first character of the gas name flashing. The current gas name and range are shown on the top line of the screen.

<p>CAT(0-50000ppm CH4)  CHANGE TO NAME  - - -  10000 - 150000  10000 ppm RATIO  1.00 FACTOR</p>
---

8. Enter the gas name. Use AIR ▲ YES and RANGE ▼ SHIFT to display the desired character, then press POWER ENTER RESET to enter the displayed character and move to the next character. Repeat until all three characters are entered. When the last character is entered, the ppm ratio value will be flashing.
9. Use AIR ▲ YES and RANGE ▼ SHIFT to display the desired ppm value. This value is called the ppm ratio and must be the ppm equivalent of the LEL for the gas being defined. For example, if you are defining propane, the LEL for propane is 21,000 ppm, so you must enter 21000 ppm (2.1% volume).

**NOTE:** If you define a gas whose LEL is above 50,000 ppm, the %LEL reading in Measuring Mode will reflect the defined ppm ratio, but the ppm reading in Measuring Mode will not indicate above 50,000 ppm. For example, if you set the ratio to be 150,000 ppm and set the catalytic combustible channel to display the reading in ppm, the gas reading will not indicate higher than 50,000 ppm, the equivalent of 33 %LEL and 5% volume for this ratio, but will continue to indicate %LEL readings up to 100 %LEL and %volume readings up to 15 %volume, the equivalent of 150,000 ppm, if the display units are changed to %LEL or %volume. In addition, all adjustable ppm parameters cannot be set higher than 50,000 ppm.

10. Press and release POWER ENTER RESET to enter the ppm ratio. The FACTOR for the gas begins to flash. The FACTOR for the gas is the response factor for the user defined gas relative to methane. The response factor must be obtained by testing the user defined gas and comparing its response to methane. This parameter is used by the relative response feature. See “Catalytic Sensor Relative Response Screen” on page 44 for a description of the relative response feature and how to use it. See “Combustible Gas Detection” on page 34 for a list of response factors for several common hydrocarbon gases that have already been tested.
11. Use AIR ▲ YES and RANGE ▼ SHIFT to increase or decrease the response factor to the desired number.
12. Press and release POWER ENTER RESET to enter the response factor. The sensor voltage setting screen appears with the sensor voltage flashing. The current gas and range is shown at the top of the screen and the current sensor voltage is shown at the bottom of the screen.

CAT(0-50000ppm CH4)

SETTING EV  
UP/DOWN THEN ENTER

2.40

The sensor voltage setting defines whether the catalytic sensor voltage is set for full response, 2.40 volts, or methane elimination, 1.30 volts. If the sensor voltage is set to 2.40 volts, the unit will default to Full Response Mode when turned on, but the methane elimination feature can be turned on in the Methane Elimination Mode Screen in Display Mode. If the sensor voltage is set to 1.3 volts, the unit will default to Methane Elimination Mode when turned on, but the methane elimination feature can be turned off in the Methane Elimination Mode Screen in Display Mode.

13. Use AIR ▲ YES or RANGE ▼ SHIFT to display the desired catalytic sensor voltage, 1.30 volts or 2.40 volts.

14. Press and release **POWER ENTER RESET**. The confirmation screen appears. In the example below, the user defined gas has been selected and defined as propane with the gas name set to **PRO**.

CHANGE TO PRO ?  
  
PRESS YES OR NO

15. If you want to accept the gas configuration change, press and release **AIR ▲ YES**. The unit will return to the **Configure Gases** screen.

CONFIGURE GASES  
  
> CAT : PRO (CAT)  
    OP1 : --- (---)  
    OP2 : --- (---)  
    OP3 : --- (---) ▼

If you do not want to accept the gas configuration change, press and release **DISPLAY ADJUST NO** to return to the screen with the gas choices shown in Step 4 on page 101. You can either scroll down to **END** and press **POWER ENTER RESET** to return to the **Configure Gases** screen or continue from Step 4 on page 101 to select a new gas.

16. Use **RANGE ▼ SHIFT** to place the cursor next to **END** and press **POWER ENTER RESET** to return to the main menu.
17. Be sure to perform a calibration on the catalytic combustible channel using an appropriate calibration cylinder for the target gas.

### Setting the Catalytic Detection Units

This menu item allows you to display the combustible gas units on the catalytic sensor channel as ppm, %LEL, %vol, or selectable between the three units (the **CHANGE OK** option). The factory setting is **CHANGE OK**.

1. From the main menu, place the cursor next to **CATALYTIC UNITS**.
2. Press and release **POWER ENTER RESET**. The **Catalytic Units** screen appears with the current setting flashing at the bottom of the screen.

CATALYTIC UNITS  
  
UP/DOWN THEN ENTER  
  
CHANGE OK

3. Use **AIR ▲ YES** or **RANGE ▼ SHIFT** to scroll through the choices, **CHANGE OK**, **vol% ONLY**, **%LEL ONLY**, and **ppm ONLY**.
4. When the desired setting is on the screen, press and release **POWER ENTER RESET** to save the setting and return to the main menu.

## Updating the Catalytic Sensor Relative Response Setting

This menu item allows you to turn the catalytic sensor relative response feature on and off. The catalytic sensor relative response feature enables you to change the catalytic sensor's response to gas on the fly so that the catalytic channel is roughly calibrated to an alternate gas. For example, if the catalytic channel is setup for and calibrated to methane, you can select hexane from a gas list accessible from the Catalytic Sensor Relative Response Screen in Display Mode so that the catalytic channel responds to gas as if it were calibrated to hexane. See "Catalytic Sensor Relative Response Screen" on page 44 for instructions to use the relative response feature.

The factory setting for **CATALYTIC SENSOR RELATIVE RESPONSE** is **OFF**.

1. From the main menu, place the cursor next to **RELATIVE RESPONSE**. Press and release **POWER ENTER RESET**. The Catalytic Sensor Relative Response screen appears with the current setting flashing.

```
CATALYTIC SENSOR
RELATIVE RESPONSE

UP/DOWN THEN ENTER

OFF
```

2. Use **AIR ▲ YES** or **RANGE ▼ SHIFT** to display the desired setting, **ON** or **OFF**.
3. Press and release **POWER ENTER RESET** to save the setting and return to the main menu.

## Updating the Alarm Point Settings

This menu item allows you to update one or more alarm points (the reading at which the EAGLE 2 recognizes the alarm condition).

1. From the main menu, place the cursor next to **ALARM POINTS**.
2. Press and release **POWER ENTER RESET**. The Change Alarm Point Settings Screen appears and all detection channels are displayed.

```
CHANGE ALARM
POINT SETTINGS
> 1: CH4  2: OXY
  3: H2S  4: CO

END
```

3. Move the cursor next to the channel of the alarm point you want to update. Press and release **POWER ENTER RESET**. The channel's alarm points are displayed (in this example for the catalytic combustible sensor channel).

```
CH4 0- 100 %LEL

>LO ALRM :    10 %LEL
HI ALRM :    50 %LEL
LO ALRM :   5000 ppm
HI ALRM :  25000 ppm ▼
```

4. Move the cursor next to the alarm point or alarm operation (oxygen only) that you want to update.

If you selected the oxygen channel, you can set the alarm rising/falling operation in addition to the alarm points.

**NOTE:** If Inert Mode is active, you can change the oxygen alarm points for both Normal Mode and Inert Mode. For more information about changing Inert Mode alarm settings, see “Appendix N: Using the EAGLE 2 in Inert Mode” on page 261.

```
OXY 0- 40.0 vol%  
  
>FALLING AND RISING  
LO ALRM : 19.5 vol%  
HI ALRM : 23.5 vol%  
END
```

5. Press and release POWER ENTER RESET. The alarm point or alarm operation (oxygen only) will begin to flash.
6. Use AIR ▲ YES and RANGE ▼ SHIFT to adjust the alarm point or alarm operation (oxygen only) to the desired setting. Keep the following in mind:
  - The low alarm cannot be set higher than the high alarm and the high alarm cannot be set lower than the low alarm.
  - Any alarm setting can be turned off by adjusting it to its lowest setting. The setting will be displayed as **OFF**.
  - In addition to setting the oxygen alarm points, you can also select one of the following operation modes: low alarm decreasing and high alarm increasing (**FALLING AND RISING**); low and high alarm decreasing (**BOTH FALLING**); low and high alarm increasing (**BOTH RISING**). The factory setting is **FALLING AND RISING**.
  - In order to appropriately set the calibration gas value during a calibration, the low alarm setting must be lower than the desired calibration value.
7. If you want to continue with the change, press and release POWER ENTER RESET to accept the setting.

If you want to exit this screen without saving any change to the alarms, press and release DISPLAY ADJUST NO until you return to the Change Alarm Point Settings Screen.

8. Repeat Step 4- Step 7 for any additional changes you want to make.
9. When you are done making changes, use RANGE ▼ SHIFT to move the cursor next to **END**.
10. Press and release POWER ENTER RESET to save the new settings and return to the Change Alarm Point Settings Screen.
11. Use RANGE ▼ SHIFT to move the cursor next to **END**.
12. Press and release POWER ENTER RESET to return to the main menu.

## Updating the Alarm Latching Setting

With **ALARM LATCHING** set to **LATCHING** (factory setting), the EAGLE 2 remains in alarm condition until the alarm condition passes *and* the POWER ENTER RESET button is pressed.

With **ALARM LATCHING** set to **SELF RESET**, the EAGLE 2 automatically resets an alarm when the alarm condition passes.

1. From the main menu, place the cursor next to **ALARM LATCHING**.
2. Press and release POWER ENTER RESET. The Alarm Latching Screen appears.

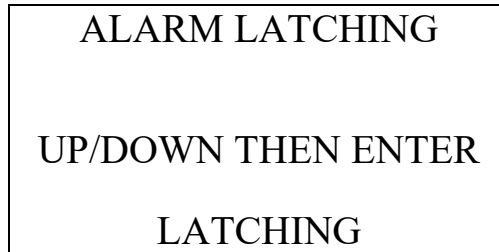

3. Use AIR ▲ YES or RANGE ▼ SHIFT to display the desired setting.
4. Press and release POWER ENTER RESET to save the setting and return to the main menu.

## Updating the Alarm Silence Setting

With **ALARM SILENCE** set to **ON** (factory setting), pressing and releasing any button silences the buzzer when the EAGLE 2 is in alarm. The LEDs continue to flash and the display continues to show the alarm. When the gas concentration falls below the alarm level, pressing and releasing POWER ENTER RESET clears all alarm indications for that alarm. If an alarm condition occurs, you may still enter Display Mode by pressing the DISPLAY button. The buzzer will be silenced but the LEDs will continue to flash. If you return to Measuring Mode and there is still an alarm condition, the LEDs will continue to flash and the buzzer will remain off. Once the condition clears, press POWER ENTER RESET to clear the alarm indications.

With **ALARM SILENCE** set to **OFF**, you cannot silence the buzzer. If an alarm condition occurs, and you enter Display Mode, the buzzer will not be silenced and the LEDs will continue to flash. Upon return to Measuring Mode, if there is still an alarm condition, you must wait until it clears before you can press POWER ENTER RESET to clear the alarm indications.

1. From the main menu, place the cursor next to **ALARM SILENCE**.
2. Press and release POWER ENTER RESET. The Alarm Silence Option Screen appears.

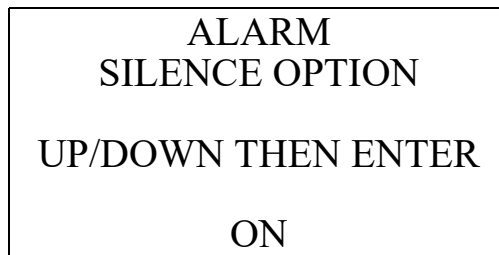

3. Use AIR ▲ YES or RANGE ▼ SHIFT to display the desired setting.
4. Press and release POWER ENTER RESET to save the setting and return to the main menu.

## Turning the User/Station ID Function On or Off

With **USER/STATION ID** set to **ON**, the ID Screen displays during start up and the Select User ID Screen and Select Station ID Screen appear in Display Mode. The ID's can be selected in Display Mode.

With **USER/STATION ID** set to **OFF** (factory setting), the ID Screen does not display during start up and the Select User ID Screen and Select Station ID Screen do not appear in Display Mode.

1. From the main menu, place the cursor next to **USER/STATION ID**.
2. Press and release **POWER ENTER RESET**. The User and Station ID's Screen appears.

**USER AND  
STATION ID'S**

**UP/DOWN THEN ENTER**

**OFF**

3. Use **AIR ▲ YES** or **RANGE ▼ SHIFT** to display the desired setting.
4. Press and release **POWER ENTER RESET** to save the setting and return to the main menu.

## Updating the Autocal Values

The EAGLE 2 stores calibration gas value settings. This allows you to calibrate all EAGLE 2 channels simultaneously with a calibration cylinder that contains all required target gases (for example the RKI 4-gas calibration cylinder).

The EAGLE 2 includes default auto calibration settings for most target gases. For gases without a default auto calibration value, the setting is 0.

**NOTE:** You can also update auto calibration settings in Calibration Mode. Updating the auto calibration gas values in Calibration Mode is normally done when performing a calibration. Updating these settings in Setup Mode allows you to update the settings without performing a calibration.

1. From the main menu, place the cursor next to **ADJ AUTOCAL VALUES**.
2. Press and release **POWER ENTER RESET**. The Adjust Auto Calibration Values Screen appears. The auto calibration value for each channel is shown.

**ADJUST AUTO  
CALIBRATION VALUES**

> CH4	50	%LEL
OXY	12.0	vol%
H2S	25.0	ppm
CO	50	ppm

▼

3. Use **AIR ▲ YES** or **RANGE ▼ SHIFT** to place the cursor next to the auto calibration value you want to change.
4. Press and release **POWER ENTER RESET**. The auto calibration value begins to flash indicating it can be adjusted.

5. Use AIR ▲ YES and RANGE ▼ SHIFT to adjust the auto calibration value to the desired value.
6. Press and release the POWER ENTER RESET button to accept the value.
7. Repeat Step 3 - Step 6 for each auto calibration value you want to change. If you want to return to the main menu at any time without saving any changes, press and release the DISPLAY ADJUST NO button until you return to the main menu.
8. Use RANGE ▼ SHIFT to move the cursor next to the **END** menu item. Press and release the POWER ENTER RESET button to save the changes and return to the main menu.

### Updating the Backlight Delay Setting

This setting indicates the length of time the LCD illuminates when you press any button. The minimum setting is 0 seconds; the maximum setting is 255 seconds. The factory setting is 30 seconds.

1. From the main menu, place the cursor next to **BACKLIGHT DELAY**.
2. Press and release POWER ENTER RESET. The Backlight Delay Screen appears.

**BACKLIGHT DELAY**

UP/DOWN THEN ENTER

30 SECONDS

3. Use AIR ▲ YES and RANGE ▼ SHIFT to adjust the time to the desired setting.
4. Press and release POWER ENTER RESET to save the setting and return to the main menu.

### Updating the Auto Fresh Air Setting

This setting allows you to configure the EAGLE 2 so that a fresh air adjustment takes place automatically as part of the instrument startup sequence. If **AUTO FRESH AIR ADJ** is set to **ON**, the EAGLE 2 performs a fresh air adjustment at the end of the startup sequence before entering Normal Operation. The factory setting is **OFF**.

**WARNING:** *If the automatic fresh air feature is turned on, you must startup the EAGLE 2 in a known fresh air environment, an environment free of toxic or combustible gases and of normal oxygen content (20.9%). If this feature is on and the EAGLE 2 is started up in the presence of a target gas, the readings and alarms will not be accurate or reliable.*

1. From the main menu, place the cursor next to **AUTO FRESH AIR ADJ**.
2. Press and release POWER ENTER RESET. The Fresh Air Adjust Screen appears.

**FRESH AIR ADJUST  
ON POWERUP**

UP/DOWN THEN ENTER

OFF

3. Use AIR ▲ YES or RANGE ▼ SHIFT to display the desired setting.
4. Press and release POWER ENTER RESET to save the setting and return to the main menu.

### Updating the Data Log Interval Setting

This setting indicates how often the EAGLE 2 saves readings to the data logger. The following interval times can be selected: 10 minutes, 5 minutes, 3 minutes, 1 minute, 30 seconds, 20 seconds, 10 seconds, or 5 seconds. The factory setting is 30 seconds.

1. From the main menu, place the cursor next to **DATA LOG INTERVAL**.
2. Press and release POWER ENTER RESET. The Data Log Interval Screen appears.

DATA LOG INTERVAL

UP/DOWN THEN ENTER

30 SECONDS

3. Use AIR ▲ YES or RANGE ▼ SHIFT to display the desired setting.
4. Press and release POWER ENTER RESET to save the setting and return to the main menu.

### Updating the Data Log Overwrite Setting

With **DATA LOG OVERWRITE** set to **ON** (factory setting), the EAGLE 2 writes over the oldest data with new data when the data logger memory is full.

With **DATA LOG OVERWRITE** set to **OFF**, the EAGLE 2 stops saving data to the data logger when the data logger memory is full.

1. From the main menu, place the cursor next to **DATA LOG OVERWRITE**.
2. Press and release POWER ENTER RESET. The Overwrite Log Data Screen appears.

OVERWRITE LOG DATA  
WHEN MEMORY IS FULL?

UP/DOWN THEN ENTER

ON

3. Use AIR ▲ YES or RANGE ▼ SHIFT to display the desired setting.
4. Press and release POWER ENTER RESET to save the setting and return to the main menu.

## Updating the Data Log Memory Setting

With **DATA LOG MEMORY** set to **ON** (factory setting), the Data Logging Screen in Display Mode asks whether you want to clear the logged data in addition to showing the log time remaining (see “Data Logging Screen” on page 51).

With **DATA LOG MEMORY** set to **OFF**, the Data Logging Screen only shows the remaining log time and does not give you the opportunity to clear the logged data.

1. From the main menu, place the cursor next to **DATA LOG MEMORY**.
2. Press and release **POWER ENTER RESET**. The Prompt to Clear Data Log Memory? Screen appears.

**PROMPT TO CLEAR  
DATA LOG MEMORY?**

**UP/DOWN THEN ENTER**

**ON**

3. Use **AIR ▲ YES** or **RANGE ▼ SHIFT** to display the desired setting.
4. Press and release **POWER ENTER RESET** to save the setting and return to the main menu.

## Updating the LCD Contrast Setting

The contrast setting controls the LCD contrast. Select the setting so the characters on the display are easy to see. It can be set from 1 to 15. The factory setting is 8. The higher the setting, the darker the characters and LCD background.

1. From the main menu, place the cursor next to **ADJUST CONTRAST**.
2. Press and release **POWER ENTER RESET**. The Adjust Contrast Screen appears.

**ADJUST CONTRAST**

**UP/DOWN THEN ENTER**

**8**

3. Use **AIR ▲ YES** or **RANGE ▼ SHIFT** to adjust the setting so that the characters on the LCD are easy to see.
4. Press and release **POWER ENTER RESET** to save the setting and return to the main menu.

## Updating the Calibration Reminder Setting

With **CAL REMINDER** set to **ON** (factory setting), the EAGLE 2 will give an indication at start up if it is due for calibration. The type of indication will depend on the **CAL PAST DUE ACT** setting (see the next menu item below).

1. From the main menu, place the cursor next to **CAL REMINDER**.
2. Press and release **POWER ENTER RESET**. The Calibration Reminder Screen appears.

**CALIBRATION  
REMINDER**

**UP/DOWN THEN ENTER**

**ON**

3. Use **AIR ▲ YES** or **RANGE ▼ SHIFT** to display the desired setting.
4. Press and release **POWER ENTER RESET** to save the setting and return to the main menu.

## Updating the Calibration Past Due Action Setting

This item defines what indication is given during start up when calibration is due and **CAL REMINDER** is set to **ON**.

With **CAL PAST DUE ACT** set to **CONFIRM TO CAL** (factory setting), the EAGLE 2 will give an indication at start up if calibration is past due and require the user to decide whether to perform a calibration or continue and use the EAGLE 2 without calibrating. Press and release **DISPLAY ADJUST NO** to continue without calibrating or **AIR ▲ YES** to perform a calibration.

With **CAL PAST DUE ACT** set to **MUST CALIBRATE**, if the unit is due for calibration, the EAGLE 2 will give an indication at start up that calibration is past due and prompt you to press and release **POWER ENTER RESET** to enter Calibration Mode and perform a calibration. Using any other button will have no effect. A successful calibration must be performed in order to use the instrument.

**NOTE:** Even if the password function is turned on in **CHANGE PASSWORD**, no password will be required to perform a calibration during startup.

With **CAL PAST DUE ACT** set to **NOTIFICATION ONLY**, the EAGLE 2 will give an indication at startup that calibration is past due. You must press and release **POWER ENTER RESET** to acknowledge the indication and proceed with the startup sequence.

1. From the main menu, place the cursor next to **CAL PAST DUE ACT**.
2. Press and release **POWER ENTER RESET**. The Calibration Past Due Action Screen appears.

**CALIBRATION PAST  
DUE ACTION**

**UP/DOWN THEN ENTER**

**CONFIRM TO CAL**

3. Use AIR ▲ YES or RANGE ▼ SHIFT to display the desired setting.
4. Press and release POWER ENTER RESET to save the setting and return to the main menu.

## Updating the Calibration Interval

This setting defines the amount of time between calibrations. The time can be set in 1 day increments. The minimum setting is 1 day and the maximum setting is 365 days. The factory setting is 90 days.

1. From the main menu, place the cursor next to **CAL INTERVAL**.
2. Press and release POWER ENTER RESET. The Set Calibration Interval Screen appears.

SET CALIBRATION  
INTERVAL

UP/DOWN THEN ENTER

90 DAYS

3. Use AIR ▲ YES or RANGE ▼ SHIFT to display the desired setting.

**Tip:** Press and hold AIR ▲ YES or RANGE ▼ SHIFT to rapidly scroll through the settings.

4. Press and release POWER ENTER RESET to save the setting and return to the main menu.

## Updating LC/BH Mode Setting

With **LC/BH MODE SELECT** set to **LC & BH**, the Mode Select Screen appears when the unit is turned on. You are able to select from Normal Mode, Leak Check Mode, and Bar Hole Mode.

With **LC/BH MODE SELECT** set to **BAR HOLE ONLY**, the Mode Select Screen appears when the unit is turned on. You are able to select from Normal Mode and Bar Hole Mode.

With **LC/BH MODE SELECT** set to **LEAK CHECK ONLY**, the Mode Select Screen appears when the unit is turned on. You are able to select from Normal Mode and Leak Check Mode.

With **LC/BH MODE SELECT** set to **OFF**, the Mode Select Screen does not appear when the unit is turned on and the unit goes into Normal Mode after the start up sequence.

This setting is factory set to **OFF** when a unit is shipped unless the instrument is ordered for bar hole measurement or leak checking use. See “Appendix K: Using the EAGLE 2 in Bar Hole Mode” and “Appendix L: Using the EAGLE 2 in Leak Check Mode” for discussions of Bar Hole Mode and Leak Check Mode, respectively.

1. From the main menu, place the cursor next to **LC/BH MODE SELECT**.

2. Press and release POWER ENTER RESET. The Leak Check/Bar Hole Mode Screen appears.

LEAK CHECK / BAR HOLE MODE  UP/DOWN THEN ENTER  OFF
--

3. Use AIR ▲ YES or RANGE ▼ SHIFT to display the desired setting.
4. Press and release POWER ENTER RESET to save the setting and return to the main menu.

### Setting the Bar Hole Measurement Time

This setting indicates the length of time the unit will sample when a bar hole measurement is initiated in Bar Hole Mode. It can be set to 30 (factory setting), 45, or 60 seconds.

1. From the main menu, place the cursor next to **BH MEASURING TIME**.
2. Press and release POWER ENTER RESET. The Bar Hole Measuring Time Screen appears.

BAR HOLE MEASURING TIME  UP/DOWN THEN ENTER  30 SECONDS
--

3. Use AIR ▲ YES or RANGE ▼ SHIFT to display the desired setting.
4. Press and release POWER ENTER RESET to save the setting and return to the main menu.

### Zero Follower Settings

The **ZERO FOLLOWER** setting is not intended for field adjustment. The default setting for most target gases is **ON**. The default setting for carbon dioxide channels and some configurations of non-standard toxic gas channels is **OFF**. The oxygen channel does not support this feature.

### Zero Suppression Settings

The **ZERO SUPPRESSION** setting is not intended for field adjustment. The typical setting is 2% of full scale. The oxygen channel does not support this feature.

### Updating the Confirmation Alert Setting

With **CONFIRMATION ALERT** set to **BEEP AND LIGHT**, the EAGLE 2 beeps and flashes the LED arrays once every 15 minutes to verify that it is operating.

With **CONFIRMATION ALERT** set to **LIGHT ONLY**, the EAGLE 2 flashes the LED arrays once every 15 minutes to verify that it is operating.

With **CONFIRMATION ALERT** set to **BEEP ONLY**, the EAGLE 2 beeps once every 15 minutes to verify that it is operating.

With **CONFIRMATION ALERT** set to **OFF** (factory setting), the EAGLE 2 does not sound a confirmation alert.

1. From the main menu, place the cursor next to **CONFIRMATION ALERT**.
2. Press and release **POWER ENTER RESET**. The Confirmation Alert Screen appears.

**CONFIRMATION ALERT**

**UP/DOWN THEN ENTER**

**OFF**

3. Use **AIR ▲ YES** or **RANGE ▼ SHIFT** to display the desired setting.
4. Press and release **POWER ENTER RESET** to save the setting and return to the main menu.

### Turning the Password Function On or Off

With **CHANGE PASSWORD** set to **ON**, the EAGLE 2 prompts you for a password when you enter Calibration Mode or Setup Mode.

**NOTE:** If a calibration is due and **CAL REMINDER** is set to **ON** and **CAL PAST DUE ACT** is set to **MUST CALIBRATE**, no password will be required to perform a calibration during startup.

With **CHANGE PASSWORD** set to **OFF** (factory setting), no password is required to enter Calibration Mode or Setup Mode.

1. From the main menu, place the cursor in front of **CHANGE PASSWORD**.
2. Press and release **POWER ENTER RESET**. The Password Protection Screen appears.

**PASSWORD  
PROTECTION**

**UP/DOWN THEN ENTER**

**OFF**

3. Use **AIR ▲ YES** or **RANGE ▼ SHIFT** to display the desired setting.
4. If you selected **OFF**, press and release **POWER ENTER RESET** to save the setting and return to the main menu.

If you selected **ON**, continue with Step 5.

5. Press and release POWER ENTER RESET. The Set Password Screen appears. The factory set pass password of 0000 is at the bottom of the screen with the first 0 flashing.

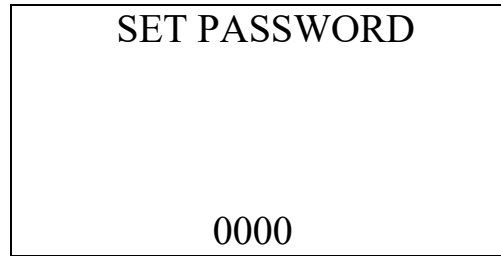

6. Use AIR ▲ YES or RANGE ▼ SHIFT to display a number from 0 to 9.
7. Press and release POWER ENTER RESET to enter the selection and advance to the next number.
8. Repeat Step 6 and Step 7 to select the remaining numbers. When you press and release POWER ENTER RESET to enter the last number, the password is saved and you return to the main menu.

### Restoring the Default Settings

Each of the EAGLE 2 setup parameters, such as the auto calibration values, zero and span settings, or parameters in Setup Mode, has a default setting. For the items in Setup Mode, the default settings are the same as the standard factory settings. If you want to return the EAGLE 2 to its default configuration, it is possible to do so by using the Default Settings menu item in Setup Mode. Returning the EAGLE 2 to its default configuration can be useful if various setup parameters have been changed in the field and you want to return the EAGLE 2 to its original configuration as shipped from the factory.

The standard default gas configuration is LEL/oxygen/H<sub>2</sub>S/CO. If you have turned any channels off or have added channels to your EAGLE 2, you will have to re-setup your EAGLE 2 to the desired gas combination if you restore the EAGLE 2 to its default configuration.

There are some special EAGLE 2 configurations that may have a different default configuration than the standard. Consult RKI Instruments, Inc. for information regarding non-standard default configurations.

**WARNING:** *When the EAGLE 2 is restored to its default configuration, the zero and span values for each channel are reset. You must recalibrate all active channels if you restore the EAGLE 2 to its default configuration.*

1. From the main menu, place the cursor in front of **DEFAULT SETTINGS**.
2. Press and release POWER ENTER RESET. The Restore Default Configuration? Screen appears asking if you want to restore the default configuration.

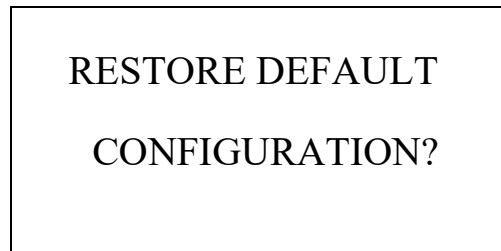

3. If you do not want to restore the default configuration, press and release DISPLAY ADJUST NO to return to the main menu.

If you do want to restore the default configuration, continue with Step 4.

4. Press and release AIR ▲ YES. A screen appears asking you to confirm that you want to restore the default configuration.

ARE YOU SURE YOU  
WANT TO SET DEFAULT  
CONFIGURATION?

5. Press and release AIR ▲ YES. The screen will indicate that the default configuration has been restored and return to the main menu.

### Updating the Lunch Break Setting

With **LUNCH BREAK** set to **OFF** (factory setting), the EAGLE 2 automatically starts new TWA and PEAK reading collection and resets the time in operation at startup.

With **LUNCH BREAK** set to **ON**, the Resume Measurements Screen displays during startup. From this screen, you can choose to continue accumulating TWA and PEAK readings and the time in operation from the last time the EAGLE 2 was used or start collecting new readings and reset the time in operation.

1. From the main menu, place the cursor next to **LUNCH BREAK**.
2. Press and release POWER ENTER RESET. The Lunch Break Screen appears.

LUNCH BREAK  
UP/DOWN THEN ENTER  
OFF

3. Use AIR ▲ YES or RANGE ▼ SHIFT to display the desired setting.
4. Press and release POWER ENTER RESET to save the setting and return to the main menu.

## Updating the Span Factor Setting

With **SPAN FACTOR** set to **ON** (factory setting), the EAGLE 2 will display the span adjustment range for a sensor in the calibration results screen while in Single Calibration. The span adjustment shows how low and how high the reading could have been adjusted.

With **SPAN FACTOR** set to **OFF**, this span adjustment does not appear in the calibration results screen.

1. From the main menu, place the cursor next to **SPAN FACTOR**.
2. Press and release **POWER ENTER RESET**. The Span Factor Screen appears.

**SPAN FACTOR DISPLAY**

**UP/DOWN THEN ENTER**

**ON**

3. Use **AIR ▲ YES** or **RANGE ▼ SHIFT** to display the desired setting.
4. Press and release **POWER ENTER RESET** to save the setting and return to the main menu.

## Updating the Language Setting

This setting allows you to select the language for the EAGLE 2's user interface. The available choices are English (factory setting), Spanish, French, Italian, and German.

1. From the main menu, place the cursor next to **SELECT LANGUAGE**.
2. Press and release **POWER ENTER RESET**. The Select Language Screen appears with the cursor in front of the current language.

**SELECT LANGUAGE**

> **ENGLISH**

**ESPAÑOL**

**FRANCAIS**

**ITALIANO**

**DEUTSCH** ▼

3. Use **AIR ▲ YES** or **RANGE ▼ SHIFT** to move the cursor in front of the desired language.

If you do not wish to select a new language, either press and release **DISPLAY ADJUST NO** or move the cursor all the way to the bottom of the list in front of **END** and press and release **POWER ENTER RESET**. The unit will return to the main menu.

4. Press and release **POWER ENTER RESET** to save the new language setting and return to the main menu. The EAGLE 2's user interface will now be in the newly selected language.

**NOTE:** If you select a language other than English, a prompt will appear during startup that allows you to change the language back to English if desired.

## Exiting Setup Mode

1. From the main menu, place the cursor in front of **NORMAL OPERATION** at the bottom of the menu.
2. Press and release **POWER ENTER RESET**.
3. A screen appears that asks if you want to save the changes you have made.

SAVE ALL CHANGES  
IN MEMORY?

**NOTE:** If you entered Setup Mode and did not make any changes, the above screen will still appear. In this case, press and release **DISPLAY ADJUST NO** to proceed to exit Setup Mode and begin the EAGLE 2's startup sequence.

4. If you do not want to save the changes, press and release **DISPLAY ADJUST NO**. The unit will begin its startup sequence without saving the changes.

If you do want to save the changes, press and release **AIR ▲ YES** and continue with the next step.

5. A confirmation screen appears asking if you are sure you want to save the changes.

ARE YOU SURE YOU  
WANT TO SAVE ALL  
CHANGES IN MEMORY?

6. If you want to save the changes, press and release **AIR ▲ YES** to save the changes. A screen will appear for a few seconds indicating that the changes have been saved and the unit will begin its start-up sequence.

If you do not want to save the changes, press and release **DISPLAY ADJUST NO** to proceed to the unit's start-up sequence without saving changes.

# Appendix C: Sub PCBs

## Overview

An EAGLE 2 that has one or more of the standard four sensors, catalytic LEL, oxygen, H<sub>2</sub>S, and CO, and no optional sensors does not have any sub PCBs installed. The sub PCBs are used to add circuitry to the EAGLE 2 that supports various optional sensors. An EAGLE 2 has provisions to install up to three sub PCBs. Although an EAGLE 2 with three sub PCBs installed can theoretically support seven sensors if you include the standard four sensors, the EAGLE 2 is only capable of having six active channels.

## Description

The main PCB can accept up to three sub PCBs. The sub PCBs are installed below a row of connectors near the top of the main PCB. The three positions are labeled on the main PCB silkscreen from right to left as SUB1, SUB2, and SUB3. These labels are not visible when the sub PCBs are installed.

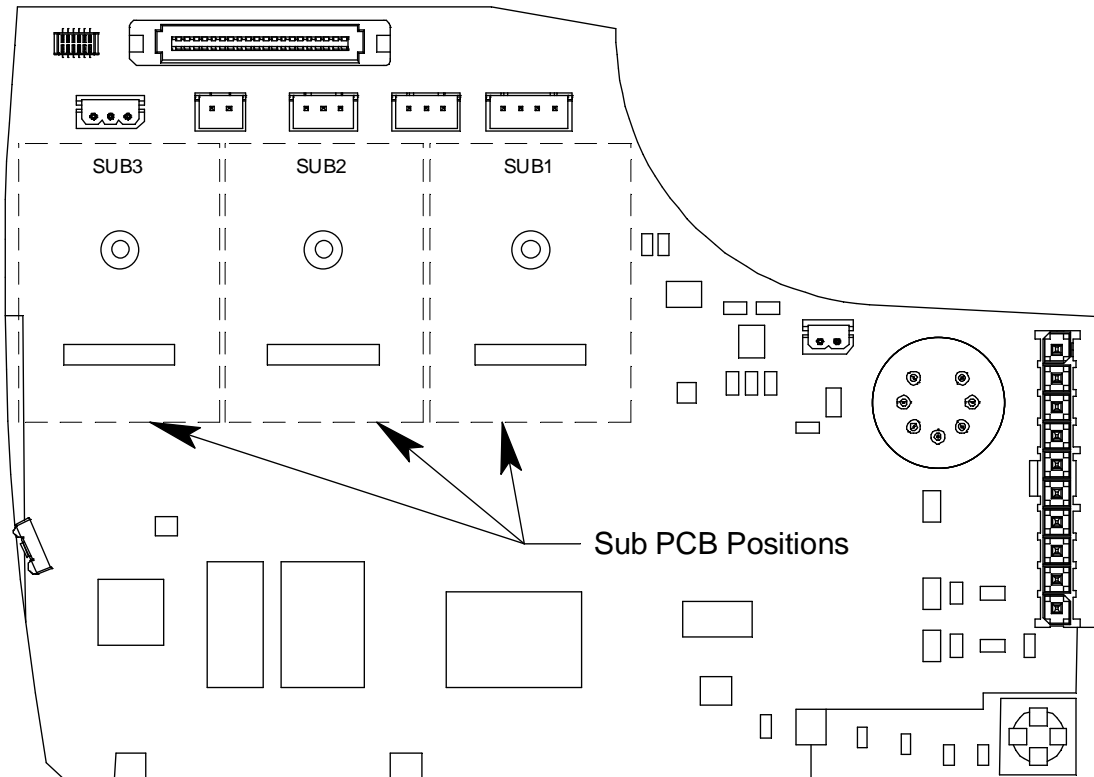

Figure 26: Sub PCB Positions

The sub PCBs plug into the main PCB with a multiposition connector and are retained in place with a screw/flat washer/lock washer. Any sub PCB can be installed in any of the sub PCB positions. A sensor that is supported by a sub PCB connects to that sub PCB with a cable. There are four types of sub PCBs, each supporting one type of optional sensor:

- The PID sub PCB supports a low range or a high range PID (photo ionization detector) sensor.
- The ESM-01 sub PCB supports any of the ESM-01 family toxic sensors.
- The TC sub PCB supports the EAGLE 2 TC (thermal conductivity) sensor.
- The Infrared (IR) sub PCB supports any of the EAGLE 2 IR sensors for combustible gas or CO<sub>2</sub>.

There are no user serviceable parts on the sub PCBs.

---

## Channel Setup & Sub PCBs

When a sub PCB is installed in a particular location, it is reflected in the CONFIGURE CHANNELS and CONFIGURE GASES menu items in Setup Mode.

### Sub PCBs and CONFIGURE CHANNELS

A channel configured as an optional sensor type supported by a sub PCB is indicated by OP1, OP2, or OP3, specifying which sub PCB position is mapped to that channel. OP1 indicates a channel supported by the SUB1 PCB, OP2 indicates a channel supported by the SUB2 PCB, and OP3 indicates a channel supported by the SUB3 PCB. The example LCD screen below illustrates the first screen in the CONFIGURE CHANNELS menu item in Setup Mode and shows a channel configuration for LEL catalytic, oxygen, H<sub>2</sub>S, and a PID sensor with the sub PCB for the PID sensor installed in location SUB1.

```
CONFIGURE CHANNELS
> CH1: CAT (CH4)
  CH2: OXY (OXY)
  CH3: H2S (H2S)
  CH4: OP1 (PID) ▼
```

If you configure a channel as an optional type that is mapped to a sub PCB position that has no sub PCB installed, the channel will be undefined and that channel will indicate a sensor failure during the startup sequence. The CONFIGURE CHANNELS LCD screen below illustrates this situation.

```
CONFIGURE CHANNELS
> CH1: CAT (CH4)
  CH2: OXY (OXY)
  CH3: H2S (H2S)
  CH4: OP1 (---) ▼
```

The “---” to the right of OP1 indicates that no sub PCB is installed in position SUB1. See “Configuring the Channels” on page 99 for a complete description of the CONFIGURE CHANNELS Setup Mode menu item.

## Sub PCBs and CONFIGURE GASES

The CONFIGURE GASES menu item in Setup Mode allows you to configure the gas for a catalytic, TC, or PID sensor that is installed. There are four possible sensors that can be configured depending on the particular version of the EAGLE 2. The LCD screen below illustrates the first screen in the CONFIGURE GASES menu item in Setup Mode.

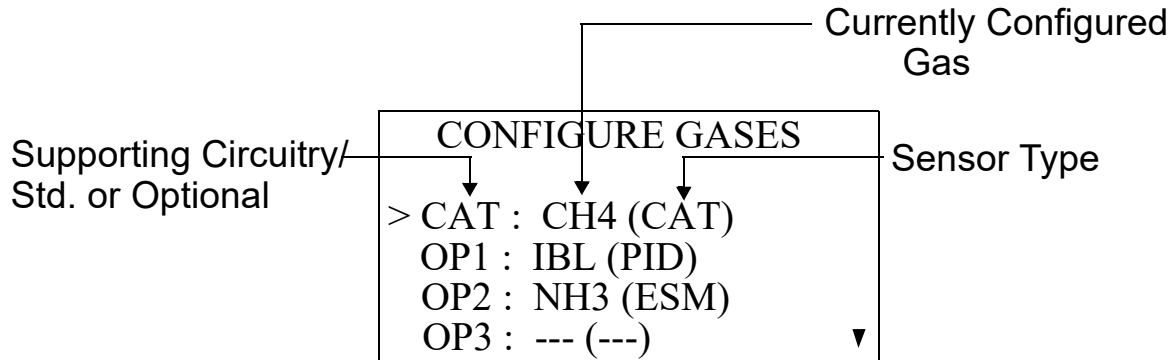

The four possible sensors are a catalytic sensor and three optional sensors. They are listed with the following information from left to right:

- The circuitry that supports the sensor and whether it is standard or optional

This can be the catalytic circuit on the main PCB indicated by CAT or one of the sub PCBs indicated by OP1 (option 1), OP2 (option 2), and OP3 (option 3). OP1 indicates that the SUB1 PCB supports the sensor, OP2 indicates that the SUB2 PCB supports the sensor, and OP3 indicates that the SUB3 PCB supports the sensor. The OP1, OP2, and OP3 identifiers also indicate that the sensor is an optional sensor. The catalytic sensor is a standard sensor. Each of these is always listed.

- The currently configured gas  
The catalytic sensor is always defined and configured even if it is not setup as active in CONFIGURE CHANNELS. If any of the Sub PCBs are not installed, then the corresponding sensor is undefined and the next two fields are filled with dashes (---). In the example above, the catalytic sensor is configured as methane (CH<sub>4</sub>), the sensor supported by the SUB1 PCB is configured as isobutylene (IBL), the sensor supported by the SUB2 PCB is configured as ammonia (NH<sub>3</sub>), and there is no sub PCB installed in position SUB3.

- The sensor type  
The sensor type can be one of the following: catalytic (CAT), photo ionization detector (PID), ESM-01 toxic (ESM), infrared (IR), or thermal conductivity (TC). Although any installed sensor type will be listed in CONFIGURE GASES, the only sensor types whose gas can be configured are catalytic, PID, and TC sensor types.

If you select an ESM-01 toxic or IR type of sensor to configure in this menu item, a message will appear indicating that the gas configuration for this sensor is automatically detected by the EAGLE 2 and that manual configuration is not possible. Both of these sensor types have the gas configuration stored in memory onboard the sensor.

ESM & IR SENSOR  
ARE AUTOMATICALLY  
DETECTED.

MANUAL SELECTION  
IS NOT POSSIBLE

See the appropriate optional sensor appendix for a complete description of configuring the gas for that type of sensor.

# Appendix D: PID Sensors

---

## Overview

The PID (photo ionization detector) sensors are used for applications where high sensitivity is needed to monitor ppm levels of VOCs (volatile organic compounds). This appendix describes the EAGLE 2's PID sensors and includes instructions to use an EAGLE 2 that has a PID sensor installed. It also includes instructions to maintain and replace a PID sensor.

**Table 13: EAGLE 2 PID Sensor Specifications**

Target Gas	Sensor Type	Detection Range	Reading Increment	Alarm 1 Factory Setting	Alarm 2 Factory Setting
VOCs, Isobutylene Calibration Standard	Low Range	0 - 50.00 ppm	0.02 ppm	5.00 ppm	10.00 ppm
	High Range	0 - 2000 ppm	1 ppm	400 ppm	1000 ppm

---

## Description

Two types of PID sensors can be used with the EAGLE 2, a low range (high sensitivity) sensor and a high range (low sensitivity) sensor (see Table 13 for specifications). The PID sensor is installed in a single sensor flow chamber which is located in the area next to the standard 4-sensor flow chamber. This area can accommodate up to three single sensor flow chambers. Figure 27 below illustrates a typical PID sensor location in front of the pump. The PID flow chamber may also be installed in one of the other two sensor chamber locations depending on the particular version of the EAGLE 2. Some PID instrument configurations do not include the 4-sensor flow chamber.

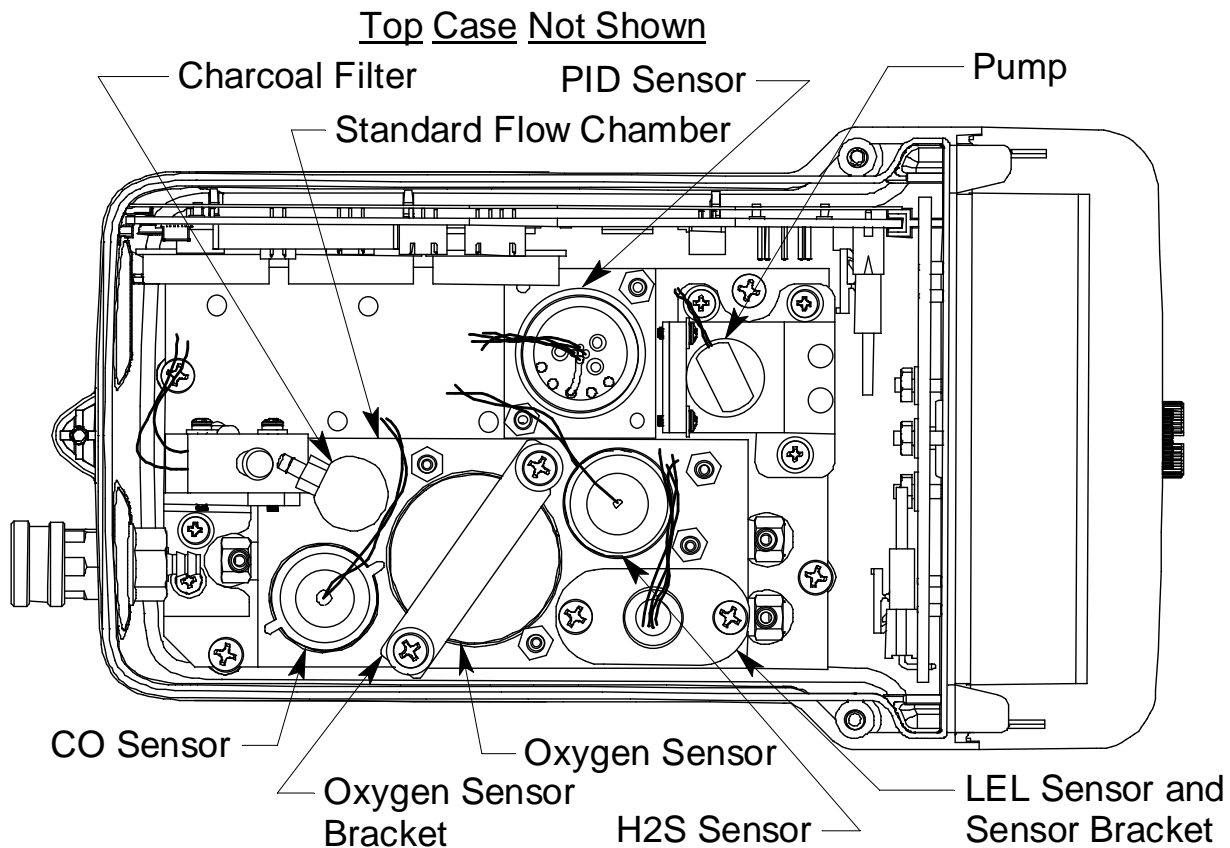

**Figure 27: Typical PID Sensor Location**

### **PID Sensor & Sensor Adapter**

The PID sensor is a cylindrical sensor with a diffusion opening on the front and 3 pins on the back. It is plugged into a sensor adapter with a 5 wire cable that terminates in a 5-position connector. The connector plugs into a PID sub PCB (see description below) that is installed on the main PCB. The sensor adapter allows installation of the PID sensor into the PID flow chamber. The sensor adapter is held in the PID flow chamber with two O-rings which also seal around the sensor adapter.

### **PID Sub PCB**

The PID sub PCB is a circuit board that is installed on the main PCB in one of the 3 sub PCB positions when a PID sensor is used with the EAGLE 2. The PID sensor adapter connects to the sub PCB with a 5-position connector. The sub PCB plugs into the main PCB and is held in place with a screw/flat washer/lock washer. There are no user serviceable parts on the PID sub PCB.

## PID Probe

Several of the gases that can be monitored with a PID are easily absorbed in the EAGLE 2's standard sample hose and standard probe. One example of this is styrene. Because of this, RKI Instruments, Inc. recommends that you use the probe intended for PID use that does not have a particle filter installed and that you install the probe directly to the inlet fitting when monitoring for gas with the PID sensor. The figure below shows an exploded drawing of the PID probe.

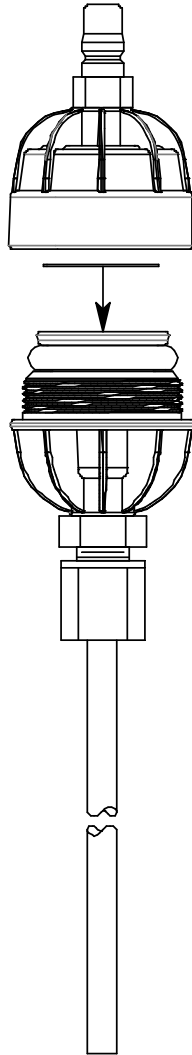

Figure 28: PID Probe

---

## Start Up and Normal Operation

For instructions to startup and use an EAGLE 2 that includes a PID sensor, reference “Start Up” on page 27, “Measuring Mode, Normal Operation” on page 33, and “Measuring Mode, Alarms” on page 38. Follow these instructions keeping the following special considerations in mind:

- After the instrument's warm up period is over and the gas readings are displayed on the screen, if the PID sensor is still in its warm up state, the gas reading for the PID channel will scroll through -200, -100, and 0 for a high range sensor and -2.00, -1.00, and 0.00 for a low range sensor. Allow the sensor to continue warming up for 5 minutes. If it exits its warm up state, the alternating numbers will be replaced by a gas

reading. If the sensor doesn't exit its warm up state after 5 minutes, see "Troubleshooting" on page 146.

- If using a probe, be sure to use the PID probe that does not have a particle filter installed. If it is necessary to use a sample hose for any reason, you must use the Teflon lined hose that is supplied with the PID instrument. A 5 foot hose is supplied as standard. 10, 15, and 20 foot hoses are also available. See the Parts List at the end of this appendix for ordering information.
- If your EAGLE 2 is a multigas unit that is used for monitoring of combustible gases in the %LEL range, the PID channel will indicate an upscale reading if one of a variety of combustible gases is present. If %LEL concentrations of one of these combustible gases is present, the PID channel may indicate an overscale reading.
- If concentrations of methane greater than 10% LEL are present in the monitoring environment, the PID channel's reading will be suppressed.
- The PID sensor will also respond to H<sub>2</sub>S, so if H<sub>2</sub>S is present, the PID channel may indicate an upscale reading depending on the concentration present.

The standard calibration for a PID channel is to isobutylene. A PID channel can be factory setup for and calibrated to other gases. Consult RKI Instruments, Inc. for other available PID configurations and to specify the desired PID configuration when a unit is ordered. The display screen below illustrates an EAGLE 2 with a low range PID sensor installed.

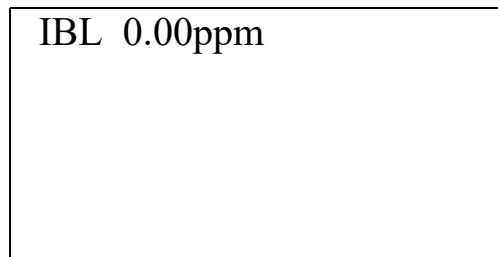

IBL 0.00ppm

It is possible to temporarily configure a PID channel for a target gas other than the factory setting in Display Mode. See the next section, "PID Relative Response Feature", for instructions to use this feature.

---

## PID Relative Response Feature

The relative response feature enables you to change the PID sensor's response to gas on the fly so that the PID channel is roughly calibrated to an alternate gas. This is done by temporarily changing the gas configuration of the PID channel. You can select from a list of gases whose response relative to the configured gas, normally isobutylene, is programmed into the EAGLE 2's memory. For example, if the PID channel is setup for and calibrated to isobutylene (IBL), you can select isopropyl alcohol (IPA) from a gas list accessible from the PID Relative Response Screen in Display Mode so that the PID channel responds to gas as if it were calibrated to isopropyl alcohol. The EAGLE 2 will clear the gas configuration change when it is turned off and will return to the programmed configuration when it is turned on again.

The gas list for the relative response feature includes several pre-defined gases and 1 gas that can be entered into the EAGLE 2 in the field using the Eagle 2 Maintenance Data Loader Program. The Eagle 2 Maintenance Data Loader Program Operator's Manual contains a chart of response factors relative to isobutylene for many gases. If the desired gas is not in this chart, gas testing must be performed to determine the gas' response factor relative to isobutylene. See the Eagle 2 Maintenance Data Loader Program Operator's

manual for details regarding the gas testing and programming user defined gases into the EAGLE 2's relative response list.

Because of normal variation between sensors, these relative response factors are typical factors. If you use this feature, the response to the selected gas will not be as accurate as it would be if you configured and calibrated the PID channel to the target gas.

For maximum accuracy, configure and calibrate the EAGLE 2's PID channel to the desired target gas.

## PID Sensor Relative Response Screen in Display Mode

To use the relative response feature for the PID sensor, enter display mode and select the desired gas as described below:

1. With the EAGLE 2 in Measuring Mode, press and release the DISPLAY ADJUST NO button repeatedly until you arrive at the PID Sensor Relative Response Screen.

SELECT  
RELATIVE RESPONSE  
TO CALIBRATED GAS  
FOR PID SENSOR

2. With the PID Sensor Relative Response Screen displayed, press and release AIR ▲ YES. A list of gases will appear on the screen with **EXIT** at the top of the list.

>EXIT  
ACETONE  
BENZENE  
DIESEL FUEL NO 1  
ETHANOL  
GASOLINE

There are multiple screens of gases. The following is the complete list of factory defined gases along with their detection ranges, low alarm, high alarm, STEL, and TWA settings. Table 14 is a list of the low range values and Table 15 is a list of the high range values.

**Table 14: Low Range Relative Response Gas List**

Target Gas	Detection Range (ppm)	Alarm 1 Factory Setting (ppm)	Alarm 2 Factory Setting (ppm)	STEL (ppm)	TWA (ppm)
Acetone	0-30.00	5.00	7.50	OFF	OFF
Benzene	0-25.00	0.50	2.50	2.50	0.50
Diesel Fuel NO 1	0-40.00	2.00	3.00	OFF	OFF
Ethanol	0-400.00	10.0	15.0	OFF	OFF
Gasoline	0-50.00	3.00	5.00	OFF	OFF
Isobutylene	0-50.00	4.30	6.00	OFF	OFF

**Table 14: Low Range Relative Response Gas List**

Isopropanol	0-200.00	2.0	4.0	OFF	OFF
JP-5 Fuel	0-30.00	1.40	2.10	OFF	OFF
Methyl Ethyl Ketone	0-40.00	2.00	3.00	OFF	OFF
Toluene	0-25.00	0.50	1.50	OFF	OFF
N-Hexane	0-200.00	5.0	10.0	OFF	OFF
Propylene	0-50.00	5.00	7.50	OFF	OFF
Styrene	0-20.00	0.20	0.40	OFF	OFF
Tetrachloro-ethylene	0-30.00	0.24	1.00	OFF	OFF
Trichloro-ethylene	0-30.00	0.50	1.00	OFF	OFF
Vinyl Chloride	0-100.00	1.0	5.0	5.0	1.0
PID	0-50.00	OFF	OFF	OFF	OFF

**Table 15: High Range Relative Response Gas List**

Target Gas	Detection Range (ppm)	Alarm 1 Factory Setting (ppm)	Alarm 2 Factory Setting (ppm)	STEL (ppm)	TWA (ppm)
Acetone	0-1000	500	750	750	500
Benzene	0-1000	50	250	OFF	OFF
Diesel Fuel NO 1	0-1500	200	300	OFF	200
Ethanol	0-15000	1000	1500	OFF	1000
Gasoline	0-2000	300	500	500	300
Isobutylene	0-2000	400	600	60	42
Isopropanol	0-5000	200	400	400	200
JP-5 Fuel	0-1000	140	210	OFF	14
Methyl Ethyl Ketone	0-1500	200	300	300	200
Toluene	0-1000	50	150	150	50
N-Hexane	0-5000	500	1000	1000	500
Propylene	0-2500	500	750	OFF	500
Styrene	0-500	20	40	40	20

Tetrachloro-ethylene	0-1000	25	100	100	25
Trichloro-ethylene	0-1000	50	100	100	50
Vinyl Chloride	0-4000	100	500	OFF	OFF
PID	0-2000	OFF	OFF	OFF	OFF

The last choice in each list, PID, can be defined by the user and loaded in the EAGLE 2 using the Eagle 2 Maintenance Data Loader Program. See the Eagle 2 Maintenance Data Loader Program Operator's Manual.

- Use the AIR ▲ YES or RANGE ▼ SHIFT button to move the cursor next to the desired gas.
- Press and release POWER ENTER RESET. The PID channel will be configured to the selected gas and the EAGLE 2 will proceed to the STEL Screen. This configuration will be in force until either a different gas is selected in Display Mode or the unit is turned off.

---

## PID Calibration

A PID channel can be calibrated using the auto calibration method or the single calibration method. To calibrate a PID channel using the single calibration method, see "Calibrating Using the Single Calibration Method" on page 62 and follow the instructions for calibrating a single channel.

**NOTE:** The factory setting for the Span Factor menu item in Setup Mode is OFF for an EAGLE 2 with a PID channel. So the range of adjustment is not displayed when a single calibration is performed for any channel if a PID sensor is installed.

If your instrument is a multi-channel instrument that includes a high range PID channel, RKI Instruments, Inc. recommends using the auto calibration method for convenience. The calibration instructions below show a 5 channel instrument which has the four standard channels, LEL/oxygen/H<sub>2</sub>S/CO, and a high range PID channel calibrated to and setup for isobutylene (IBL). There are two ways to calibrate an EAGLE 2 with a PID channel installed. The first way, described below in "Calibrating with a 4-Gas Cylinder and a PID Cylinder" on page 131, uses a 4-gas cylinder and an appropriate PID cylinder. The second way, described below in "Calibrating with a 5-Gas Cylinder" on page 139, uses a multi-gas cylinder that contains the target gas for all installed sensors. Follow the set of instructions appropriate for your cylinder configuration.

### Calibrating with a 4-Gas Cylinder and a PID Cylinder

- See "Calibration Supplies and Equipment" on page 55 for a description of the necessary calibration supplies. In addition to an appropriate multi-gas cylinder that is used to calibrate any active standard channels, you will also need a cylinder to calibrate the PID channel. See Table 18 on page 162 for available cylinders. Make sure your calibration cylinder is appropriate for the PID detection range.
- Find a fresh-air environment. This is an environment free of toxic or combustible gases and of normal oxygen content (20.9%).

3. While in Measuring Mode, press and hold the RANGE ▼ SHIFT button, then press the DISPLAY ADJUST NO button and release both buttons.
4. If the unit prompts you for the password, enter it by using the AIR ▲ YES and RANGE ▼ SHIFT buttons to select each password number and then pressing and releasing POWER ENTER RESET to enter the number and move on to the next one.
5. The Calibration Mode Screen displays with the cursor next to **AUTO CALIBRATION**.

```
CALIBRATION MODE
> AUTO CALIBRATION
  SINGLE CALIBRATION
  PERFORM AIR ADJUST
  NORMAL OPERATION
```

6. Move the cursor to the **PERFORM AIR ADJUST** menu item by using the RANGE ▼ SHIFT button.

```
CALIBRATION MODE

  AUTO CALIBRATION
  SINGLE CALIBRATION
  > PERFORM AIR ADJUST
  NORMAL OPERATION
```

7. Press and release the POWER ENTER RESET button. The following screen appears.

```
PERFORM
AIR ADJUST?
```

8. Press and release the AIR ▲ YES button to continue. If you do not want to continue, press the DISPLAY ADJUST NO button and the unit will return to the Calibration Mode Screen.

9. The EAGLE 2 will indicate that it is adjusting the zero reading for a few seconds, then indicate that the operation is complete before returning to the Calibration Mode Screen.

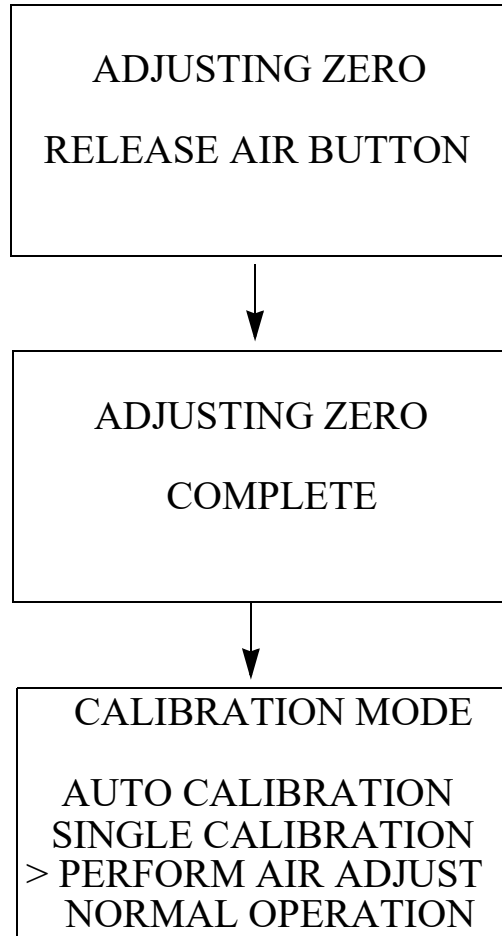

10. Install the demand flow regulator onto the multi-gas calibration cylinder.
11. Connect the sample tubing to the demand flow regulator.
12. Install the probe on the EAGLE 2 inlet fitting. Make sure the probe is complete with internal O-ring and membrane and that the two halves of the probe are tightened firmly together to avoid leaks that can affect the calibration. See Figure 21, “Replacing the Particle Filter and Hydrophobic Filter Disk” on page 72 for an illustration of the internal parts of the probe.
13. Move the cursor next to the **AUTO CALIBRATION** menu item by using the AIR ▲ YES button.

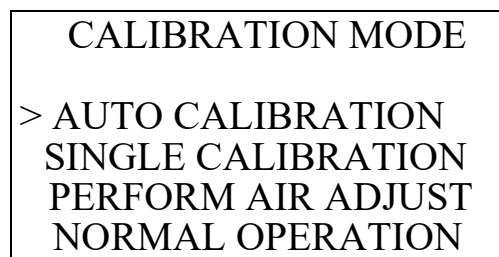

14. Press and release the POWER ENTER RESET button to display the Calibration Gas Values Screen.

CAL GAS VALUES		
CH4	50	%LEL
OXY	12.0	vol%
H2S	25.0	ppm
CO	50	ppm
ENTER TO BEGIN CAL		

The gas concentrations displayed in the Calibration Gas Values Screen must match the gas concentrations listed on the 4-gas calibration cylinder.

If *all* concentrations match, go to Step 25.

If *one or more* concentrations *do not* match, continue with Step 15.

If you do not want to continue with the calibration, press and release the DISPLAY ADJUST NO button to return to the Calibration Mode Screen.

**NOTE:** The RKI 4-gas cylinder typically contains 12% O<sub>2</sub> by volume. When using the auto calibration method, be sure to set the “OXY” auto calibration value to agree with the concentration listed on the cylinder’s label, not zero.

15. To adjust the values on the screen, press and hold the RANGE ▼ SHIFT button, then press the DISPLAY ADJUST NO button and release both. The following screen appears with the cursor next to **CH4**.

ADJUST AUTO CALIBRATION VALUES		
> CH4	50	%LEL
OXY	12.0	vol%
H2S	25.0	ppm
CO	50	ppm ▼

16. Place the cursor next to the channel whose gas value you want to change using the AIR ▲ YES and RANGE ▼ SHIFT buttons.
17. Press and release the POWER ENTER RESET button to select the channel. The calibration gas value begins to flash.
18. Use the AIR ▲ YES and RANGE ▼ SHIFT buttons to adjust the calibration gas setting to the desired value.

**NOTE:** The calibration gas value cannot be set lower than the low alarm setting. If the calibration gas value listed on the calibration cylinder is lower than the current low alarm setting, enter Setup Mode and change the low alarm setting. See “Updating the Alarm Point Settings” on page 106 for instructions. If you need to change the alarm point setting only to perform a calibration, make sure that you change the alarm point setting back to its original value once the calibration has been performed.

19. Press and release the POWER ENTER RESET button to save the change. The calibration gas value stops flashing.
20. Repeat Step 15 through Step 19 for any other channels that need to be changed.

21. When you are done adjusting the calibration gas values, move the cursor down past the bottom of the screen next to **END**.

```
ADJUST AUTO
CALIBRATION VALUES
> END ▲
```

22. Press and release the POWER ENTER RESET button. The following screen appears.

```
DO YOU WANT TO
STORE NEW VALUE(S)
IN MEMORY FOR
FUTURE CALIBRATIONS?

PRESS YES OR NO
```

23. If you select YES by pressing and releasing the AIR ▲ YES button, the changes that you made will be saved in the EAGLE 2's memory as the new auto calibration gas values.

If you select NO by pressing and releasing the DISPLAY ADJUST NO button, the changes you made will be used for any calibrations performed during the current operating session only. The EAGLE 2 will delete the changes when the unit is turned off and will load the previous set of auto calibration values when it is turned on again.

24. When you make your selection and press the desired button, the unit returns to the Calibration Gas Values Screen.

```
CAL GAS VALUES
CH4  50 %LEL
OXY  12.0 vol%
H2S  25.0 ppm
CO   50 ppm
ENTER TO BEGIN CAL
```

25. Press and release the POWER ENTER RESET button to proceed to the Calibration In Process Screen with **CAL IN PROCESS** flashing.

```
CAL IN PROCESS
CH4    0 %LEL
OXY  20.9 vol%
H2S   0.0 ppm
CO    0 ppm
ENTER WHEN DONE
```

If you do not want to proceed with the calibration, press and release the DISPLAY ADJUST NO button to return to the Cal Gas Values Screen.

If you do want to continue with the calibration, proceed to the next step.

26. Connect the tubing from the demand flow regulator to the rigid tube on the probe. Allow the EAGLE 2 to draw gas for one minute.
27. Press and release the POWER ENTER RESET button to set the span adjustment for each channel to the programmed values.
28. If all channels passed calibration, the following screen sequence occurs.

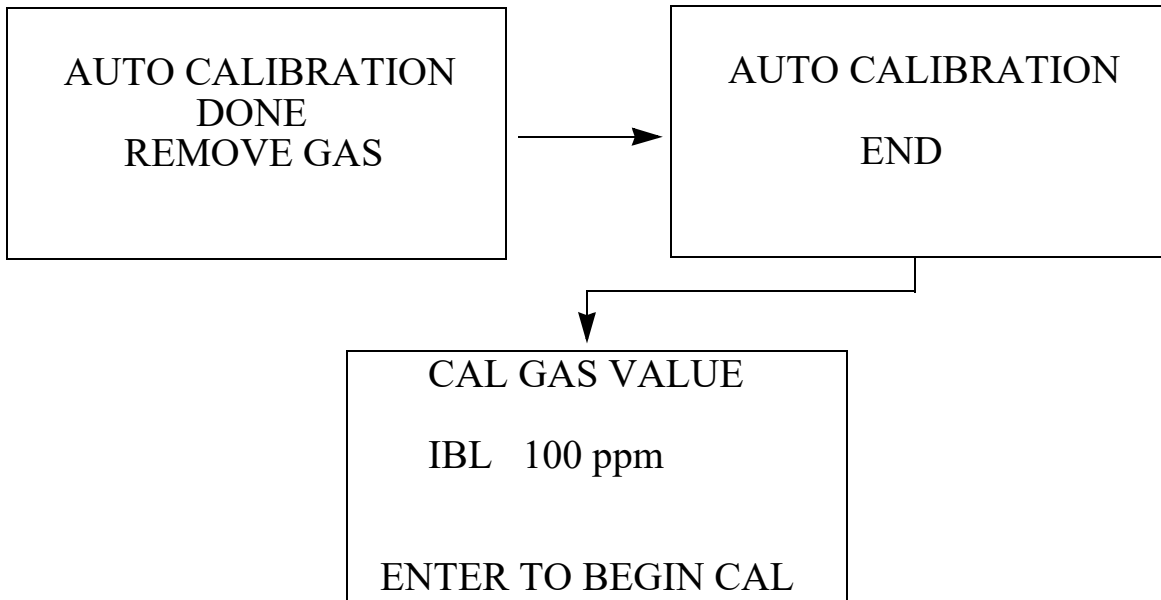

If any of the sensors cannot be adjusted to the proper value, a screen displays that indicates a calibration failure and lists the sensor(s) that failed to calibrate. In the example below, the oxygen and H<sub>2</sub>S channels failed calibration. The other sensors calibrated normally.

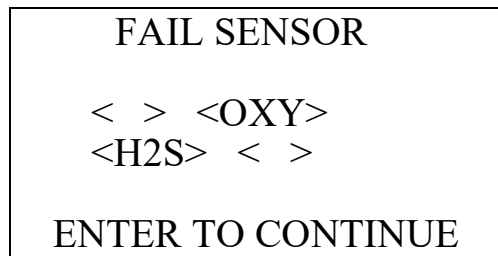

The buzzer and alarm LEDs activate in a double pulsing pattern. Press and release the POWER ENTER RESET button to reset the alarm and continue to the Calibration Value Screen for the PID channel. After calibrating the PID channel by following the instructions below, attempt to calibrate the standard channels again. If the failure continues, investigate the cause. See “Troubleshooting” on page 67.

29. Remove the tubing from the rigid tube on the probe.
30. Unscrew the 4-gas cylinder from the regulator.

31. If you want to change the PID channel's calibration gas value, follow Step 5 - Step 24 above beginning with the PID Calibration Gas Value Screen below instead of the standard channel Calibration Gas Value Screen.

<p>CAL GAS VALUE</p> <p>IBL 100 ppm</p> <p>ENTER TO BEGIN CAL</p>
---

32. With the PID Calibration Gas Value Screen displayed, press and release the POWER ENTER RESET button to proceed to the Calibration In Process Screen for the PID channel with **CAL IN PROCESS** flashing.

<p>CAL IN PROCESS</p> <p>IBL 0 ppm</p> <p>ENTER WHEN DONE</p>
---

If you do not want to proceed with the calibration, press and release the DISPLAY ADJUST NO button to return to the PID Cal Gas Values Screen.

If you do want to continue with the calibration, proceed to the next step.

33. Screw the PID calibration cylinder onto the demand flow regulator.
34. Connect the tubing from the regulator to the rigid tube on the probe. Allow the EAGLE 2 to draw gas for one minute.
35. Press and release the POWER ENTER RESET button to set the span adjustment for the PID channel to the programmed value.

36. If the PID channel passed calibration, the following screen sequence occurs.

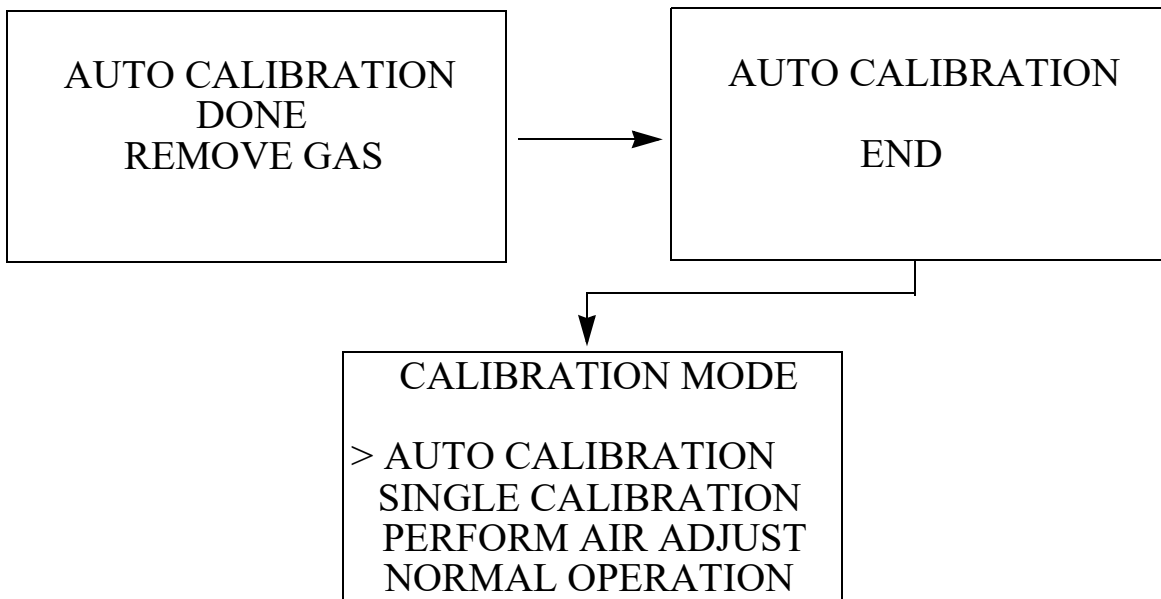

If the PID channel cannot be adjusted to the proper value, a screen displays that indicates a calibration failure and indicates that the PID sensor failed to calibrate.

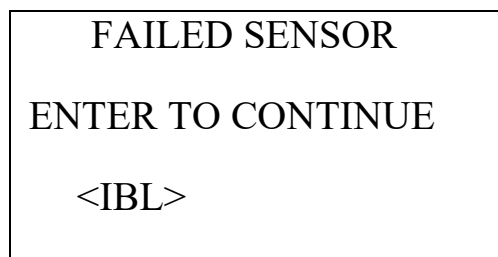

The buzzer and alarm LEDs activate in a double pulsing pattern. Press and release the POWER ENTER RESET button to reset the alarm and continue to the Calibration Mode Screen. Attempt to calibrate the PID channel again. If the failure continues, investigate the cause. See "Troubleshooting" on page 67.

37. Disconnect the tubing from the probe.
38. Unscrew the demand flow regulator from the calibration cylinder.
39. Use the RANGE ▼ SHIFT button to place the cursor next to the **NORMAL OPERATION** menu option, then press and release the POWER ENTER RESET button to return to Measuring Mode.

## Calibrating with a 5-Gas Cylinder

1. See “Calibration Supplies and Equipment” on page 55 for a description of the necessary calibration supplies. See Table 18 on page 162 for available cylinders. Make sure your calibration cylinder is appropriate for the PID detection range.

**NOTE:** The 5-gas calibration cylinder that includes LEL CH<sub>4</sub>/O<sub>2</sub>/CO/H<sub>2</sub>S/isobutylene is a proprietary gas mix developed by RKI Instruments, Inc. for calibrating a PID sensor in the presence of the other gases during an auto calibration. It can also be used for a single calibration of a PID sensor. Do not use a similar gas mix provided by any other manufacturer when calibrating a PID channel. Use of a gas mix from another manufacturer that includes isobutylene and these other gases will result in an inaccurate calibration.

2. Find a fresh-air environment. This is an environment free of toxic or combustible gases and of normal oxygen content (20.9%).
3. While in Measuring Mode, press and hold the RANGE ▼ SHIFT button, then press the DISPLAY ADJUST NO button and release both buttons.
4. If the unit prompts you for the password, enter it by using the AIR ▲ YES and RANGE ▼ SHIFT buttons to select each password number and then pressing and releasing POWER ENTER RESET to enter the number and move on to the next one.
5. The Calibration Mode Screen displays with the cursor next to **AUTO CALIBRATION**.

```
CALIBRATION MODE
> AUTO CALIBRATION
  SINGLE CALIBRATION
  PERFORM AIR ADJUST
  NORMAL OPERATION
```

6. Move the cursor to the **PERFORM AIR ADJUST** menu item by using the RANGE ▼ SHIFT button.

```
CALIBRATION MODE

  AUTO CALIBRATION
  SINGLE CALIBRATION
> PERFORM AIR ADJUST
  NORMAL OPERATION
```

7. Press and release the POWER ENTER RESET button. The following screen appears.

```
PERFORM
AIR ADJUST?
```

8. Press and release the AIR ▲ YES button to continue.  
If you do not want to continue, press the DISPLAY ADJUST NO button and the unit will return to the Calibration Mode Screen.
9. The EAGLE 2 will indicate that it is adjusting the zero reading for a few seconds, then indicate that the operation is complete before returning to the Calibration Mode Screen.

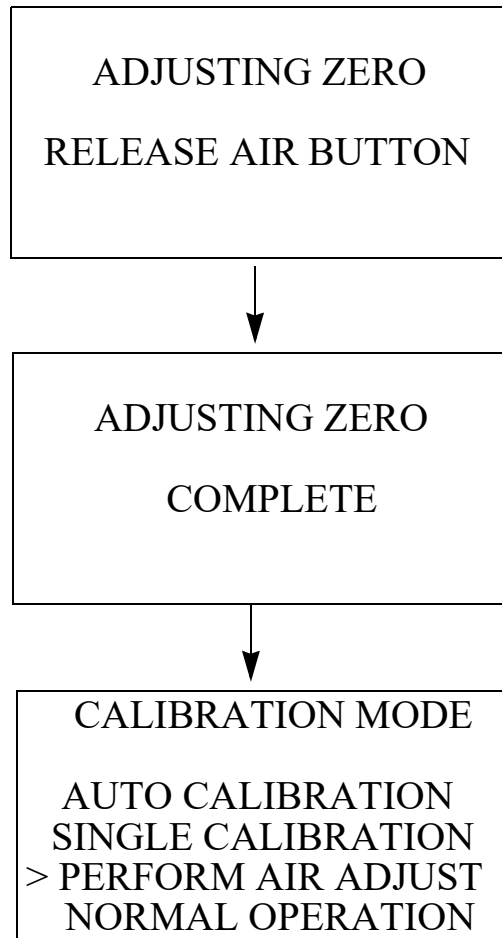

10. Install the demand flow regulator onto the multi-gas calibration cylinder.
11. Connect the sample tubing to the demand flow regulator.
12. Install the probe on the EAGLE 2 inlet fitting. Make sure the probe is complete with internal O-ring and membrane and that the two halves of the probe are tightened firmly together to avoid leaks that can affect the calibration. See Figure 21, “Replacing the Particle Filter and Hydrophobic Filter Disk” on page 72 for an illustration of the internal parts of the probe.

13. Move the cursor next to the **AUTO CALIBRATION** menu item by using the AIR ▲ YES button.

```
CALIBRATION MODE
> AUTO CALIBRATION
  SINGLE CALIBRATION
  PERFORM AIR ADJUST
  NORMAL OPERATION
```

14. Press and release the POWER ENTER RESET button to display the Calibration Gas Values Screen.

```
CAL GAS VALUES
CH4  50 %LEL
OXY  12.0 vol%
H2S  25.0 ppm
CO   50 ppm
ENTER TO BEGIN CAL
```

The gas concentrations displayed in the Calibration Gas Values Screen must match the gas concentrations listed on the 4-gas calibration cylinder.

If *all* concentrations match, go to Step 25.

If *one or more* concentrations *do not* match, continue with Step 15.

If you do not want to continue with the calibration, press and release the DISPLAY ADJUST NO button to return to the Calibration Mode Screen.

**NOTE:** The RKI 4-gas cylinder typically contains 12% O<sub>2</sub> by volume. When using the auto calibration method, be sure to set the “OXY” auto calibration value to agree with the concentration listed on the cylinder’s label, not zero.

15. To adjust the values on the screen, press and hold the RANGE ▼ SHIFT button, then press the DISPLAY ADJUST NO button and release both. The following screen appears with the cursor next to **CH4**.

```
ADJUST AUTO
CALIBRATION VALUES
> CH4  50 %LEL
  OXY  12.0 vol%
  H2S  25.0 ppm
  CO   50 ppm ▼
```

16. Place the cursor next to the channel whose gas value you want to change using the AIR ▲ YES and RANGE ▼ SHIFT buttons.
17. Press and release the POWER ENTER RESET button to select the channel. The calibration gas value begins to flash.

18. Use the AIR ▲ YES and RANGE ▼ SHIFT buttons to adjust the calibration gas setting to the desired value.

**NOTE:** The calibration gas value cannot be set lower than the low alarm setting. If the calibration gas value listed on the calibration cylinder is lower than the current low alarm setting, enter Setup Mode and change the low alarm setting. See “Updating the Alarm Point Settings” on page 106 for instructions. If you need to change the alarm point setting only to perform a calibration, make sure that you change the alarm point setting back to its original value once the calibration has been performed.

19. Press and release the POWER ENTER RESET button to save the change. The calibration gas value stops flashing.
20. Repeat Step 15 through Step 19 for any other channels that need to be changed.
21. When you are done adjusting the calibration gas values, move the cursor down past the bottom of the screen next to **END**.

ADJUST AUTO  
CALIBRATION VALUES  
> END ▲

22. Press and release the POWER ENTER RESET button. The following screen appears.

DO YOU WANT TO  
STORE NEW VALUE(S)  
IN MEMORY FOR  
FUTURE CALIBRATIONS?  
  
PRESS YES OR NO

23. If you select YES by pressing and releasing the AIR ▲ YES button, the changes that you made will be saved in the EAGLE 2’s memory as the new auto calibration gas values.

If you select NO by pressing and releasing the DISPLAY ADJUST NO button, the changes you made will be used for any calibrations performed during the current operating session only. The EAGLE 2 will delete the changes when the unit is turned off and will load the previous set of auto calibration values when it is turned on again.

24. When you make your selection and press the desired button, the unit returns to the Calibration Gas Values Screen.

CAL GAS VALUES  
CH4 50 %LEL  
OXY 12.0 vol%  
H2S 25.0 ppm  
CO 50 ppm  
ENTER TO BEGIN CAL

25. Press and release the POWER ENTER RESET button to proceed to the Calibration In Process Screen with **CAL IN PROCESS** flashing.

```
CAL IN PROCESS
CH4    0  %LEL
OXY  20.9 vol%
H2S   0.0 ppm
CO    0  ppm
ENTER WHEN DONE
```

If you do not want to proceed with the calibration, press and release the DISPLAY ADJUST NO button to return to the Cal Gas Values Screen.

If you do want to continue with the calibration, proceed to the next step.

26. Connect the tubing from the demand flow regulator to the rigid tube on the probe. Allow the EAGLE 2 to draw gas for one minute.
27. Press and release the POWER ENTER RESET button to set the span adjustment for each channel to the programmed values.
28. If all channels passed calibration, the following screen sequence occurs.

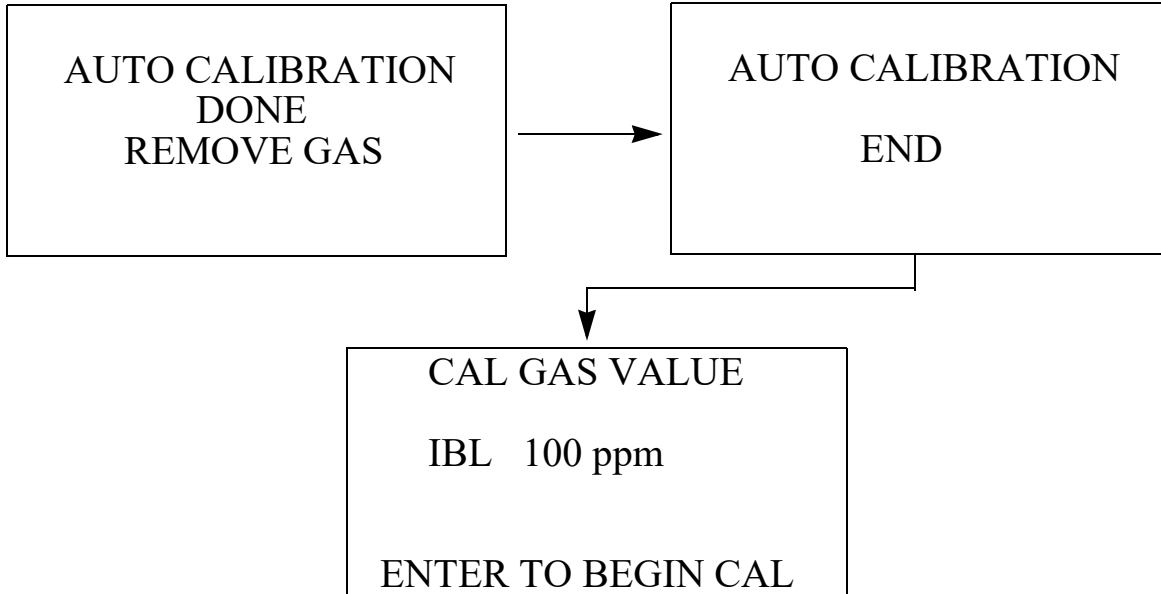

If any of the sensors cannot be adjusted to the proper value, a screen displays that indicates a calibration failure and lists the sensor(s) that failed to calibrate. In the example below, the oxygen and H<sub>2</sub>S channels failed calibration. The other sensors calibrated normally.

```
FAIL SENSOR

< > <OXY>
<H2S> < >

ENTER TO CONTINUE
```

The buzzer and alarm LEDs activate in a double pulsing pattern. Press and release the POWER ENTER RESET button to reset the alarm and continue to the Calibration

Value Screen for the PID channel. After calibrating the PID channel by following the instructions below, attempt to calibrate the standard channels again. If the failure continues, investigate the cause. See “Troubleshooting” on page 67.

29. If you want to change the PID channel’s calibration gas value, follow Step 5 - Step 24 above beginning with the PID Calibration Gas Value Screen below instead of the standard channel Calibration Gas Value Screen.

<p>CAL GAS VALUE</p> <p>IBL 100 ppm</p> <p>ENTER TO BEGIN CAL</p>
---

30. With the PID Calibration Gas Value Screen displayed, press and release the POWER ENTER RESET button to proceed to the Calibration In Process Screen for the PID channel with **CAL IN PROCESS** flashing.

<p>CAL IN PROCESS</p> <p>IBL 94 ppm</p> <p>ENTER WHEN DONE</p>
--

If you do not want to proceed with the calibration, press and release the DISPLAY ADJUST NO button to return to the PID Cal Gas Values Screen.

If you do want to continue with the calibration, proceed to the next step.

31. Since calibration gas has already been flowing to the PID sensor while the other channels were being calibrated, the PID sensor reading should be stable and ready for adjustment.
32. Press and release the POWER ENTER RESET button to set the span adjustment for the PID channel to the programmed value.

33. If the PID channel passed calibration, the following screen sequence occurs.

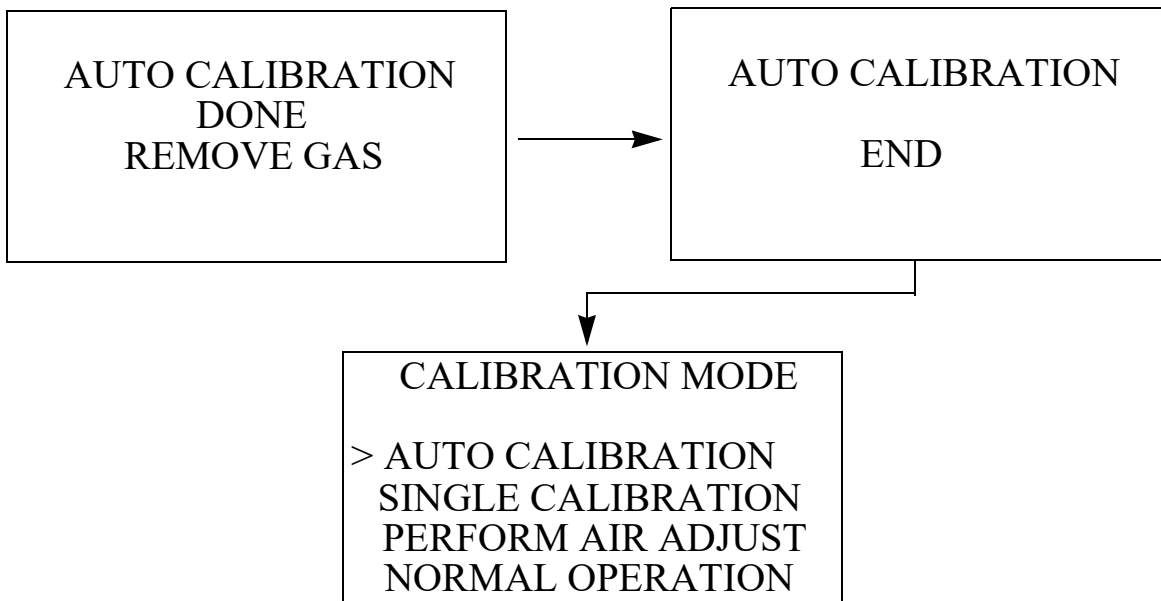

If the PID channel cannot be adjusted to the proper value, a screen displays that indicates a calibration failure and indicates that the PID sensor failed to calibrate.

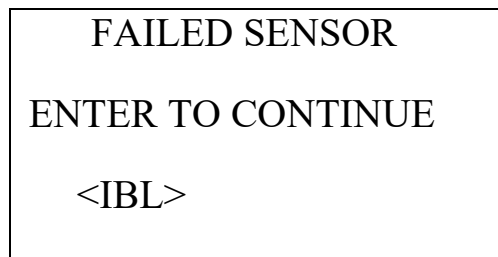

The buzzer and alarm LEDs activate in a double pulsing pattern. Press and release the POWER ENTER RESET button to reset the alarm and continue to the Calibration Mode Screen. Attempt to calibrate the PID channel again. If the failure continues, investigate the cause. See "Troubleshooting" on page 67.

34. Disconnect the tubing from the probe.
35. Unscrew the demand flow regulator from the calibration cylinder.
36. Use the RANGE ▼ SHIFT button to place the cursor next to the **NORMAL OPERATION** menu option, then press and release the POWER ENTER RESET button to return to Measuring Mode.

## Maintenance

The PID sensor includes user serviceable parts. They are the lamp and the electrode stack. The following sections include troubleshooting instructions as well as procedures for cleaning the lamp, replacing the lamp, replacing the electrode stack, and replacing the PID sensor.

### Troubleshooting

The troubleshooting table describes symptoms, probable causes, and recommended action for problems you may encounter with the PID sensor.

Symptoms	Probable Causes	Recommended Action
<ul style="list-style-type: none"><li>• PID channel doesn't exit its warm up state and the reading continues to scroll through -200, -100, and 0 for a high range sensor and -2.00, -1.00, and 0.00 for a low range sensor.</li></ul>	<ul style="list-style-type: none"><li>• The PID sensor has not come out of its warm up state.</li></ul>	<ol style="list-style-type: none"><li>1. Clean the lamp.</li><li>2. Replace the lamp.</li><li>3. Replace the electrode stack.</li><li>4. If the difficulties continue, contact RKI Instruments, Inc. for further instruction.</li></ol>
<ul style="list-style-type: none"><li>• The PID sensor fails to calibrate.</li></ul>	<ul style="list-style-type: none"><li>• The auto calibration values may not match the cylinder gas concentration (auto calibration only).</li><li>• The sample gas is not reaching the sensor because of a bad connection.</li><li>• The calibration cylinder may be out of gas or is outdated.</li><li>• The lamp may need to be cleaned.</li><li>• The electrode stack may need to be replaced.</li></ul>	<ol style="list-style-type: none"><li>1. Make sure the EAGLE 2 has been properly set up for calibration.</li><li>2. Check all calibration tubing for leaks or for any bad connections.</li><li>3. Verify that the calibration cylinder contains an adequate supply of sample.</li><li>4. Clean the lamp.</li><li>5. Replace the electrode stack.</li><li>6. If the difficulties continue, contact RKI Instruments, Inc. for further instruction.</li></ol>

### Cleaning the PID Sensor's Lamp

Clean the lamp if you notice a significant drop in sensitivity from one scheduled calibration to another or if you are not able to calibrate the PID channel. See the "PID EAGLE 2 Spare Parts" on page 162 for lamp cleaning kit ordering information. The lamp cleaning kit includes the following items:

- an electrode stack removal tool
- a small vial of aluminum oxide powder
- 40 cotton swabs
- 10 finger cots

Perform the following procedure to clean the PID lamp:

1. Verify that the EAGLE 2 is off.

2. Place the EAGLE 2 upside down on a flat surface or hold it upside down.
3. Unscrew the three case screws until they disengage from the top case. They are captive screws so they will not fall off of the bottom case.
4. Turn the EAGLE 2 right side up and carefully lift the top case away from the bottom case. Be careful not to lift it so far that it pulls on the main PCB with the cable that connects the top case to the main PCB.
5. Lay the top case down next to the bottom case to allow access to the flow system.
6. Locate the PID sensor adapter. It has a five wire cable and is normally located next to the pump. The cable has a connector that mates to a PID sub PCB that is installed on the main PCB. Figure 27 on page 126 shows a PID sensor in a typical location.
7. Grasp the sensor adapter firmly and pull it out of the PID flow chamber. Rock it back and forth gently if necessary to pull it out. Take care not to pull the cable connector from the PID sub PCB.
8. The PID sensor protrudes from one end of the sensor adapter. Grasp the PID sensor firmly and pull it out of the sensor adapter.
9. Place the PID sensor face down on a flat clean working surface.

**NOTE:** Do not touch the lamp window with your fingers as this may contaminate the window with finger oil. At this point it is recommended that the finger cots be used on the fingers handling the lamp. Finger cots are included with the lamp cleaning kit.

10. Hold the PID sensor steady on the working surface with one hand and using the other hand, locate the tabs on the electrode stack removal tool and insert them into the slots on the side of the PID sensor near the face.



**Figure 29: Using Removal Tool**

11. Squeeze the removal tool to push the tabs into the sensor slots until the electrode stack and lamp are released.
12. Carefully lift the PID sensor body away from the electrode stack and lamp. Take care not to touch the lamp window, the flat end of the lamp, with your fingers. If the lamp

remains lodged in the sensor body, carefully remove it with tweezers.



**Figure 30: Lamp Window Location**

13. If the spring in the lamp cavity comes out, place it back into the lamp cavity.
14. Hold the lamp in one hand being careful not to touch the lamp window with your fingers.
15. With the other hand collect a small amount of aluminum oxide powder on a cotton swab.
16. Use this cotton swab to polish the PID lamp window. Use a circular motion, applying light pressure to clean the lamp window. Do not touch the lamp window with your fingers.



**Figure 31: Polishing the Electrode Lamp Window**

17. Continue polishing until you can hear a squeaking sound made by the cotton swab moving over the window surface. This usually occurs after about 15 seconds of polishing.
18. Remove the residual powder from the lamp window with a clean cotton swab. Take care not to touch the tip of the cotton swab that is used to clean the lamp as this may contaminate it with finger oil.
19. Ensure the lamp is completely dry and any visible signs of contamination are removed before reinstalling.

20. Hold the electrode stack between the thumb and forefinger of one hand and place the window end of the lamp inside the O-ring seal in the electrode stack with the other hand as shown below.

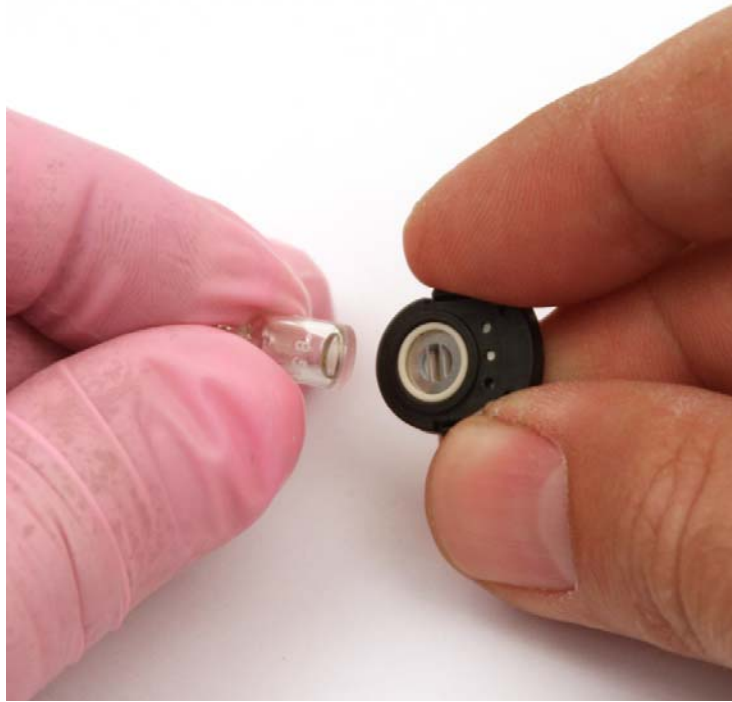

**Figure 32: Reinstalling the Electrode Lamp**

21. Twisting the lamp slightly during insertion will help to ensure the lamp window is snug against the stack's front electrode. The lamp should be supported by the O-ring.
22. Continuing to hold the electrode stack between your forefinger and thumb, carefully insert the lamp into the lamp cavity in the sensor ensuring that the lamp remains in position.
23. Press in the electrode stack firmly to ensure that the stack wing clips are engaged and the faces of the stack and sensor body are flush.
24. Carefully line up the PID sensor's pins with the sockets in the bottom of the sensor adapter and gently lower the sensor into the adapter until you feel it contact the bottom.
25. Do not attempt to push the sensor in farther once it makes contact with the bottom of the adapter until you are sure that the sensor's pins are engaged with the sockets. If you feel that the pins did not engage the sockets, slightly rotate the sensor back and forth without putting pressure on it until you feel the pins engage the sockets.
26. Push the sensor into the sockets until it bottoms out.
27. Insert the sensor adapter into the PID flow chamber and push it in until it bottoms out.
28. Confirm that the main PCB is seated in its slots and that its bottom edge is resting on the bottom of the bottom case. If the main PCB is not seated properly, it may be damaged when the top case is re-installed.
29. Make sure that the top case gasket is fully seated in its groove and carefully put the top case back on the bottom case. If you have any difficulty mating the top and bottom cases, inspect the placement of the main PCB and the placement of the top case gasket.

30. Turn the EAGLE 2 upside down and tighten the three case screws to secure the top case to the bottom case.

31. Calibrate the PID channel as described in “PID Calibration” on page 131.

### Replacing the PID Sensor’s Lamp

If cleaning the PID lamp does not resolve any calibration problems you may be having, the lamp may need to be replaced.

#### Ordering the Correct Replacement Lamp

It’s important to order the correct replacement lamp for your PID sensor.

1. If you have a 61-0300RK-01 or a 61-0301-02 sensor, you need to:
  - a. Pull the PID sensor out of the socket and look at the pins on the underside of the sensor.
  - b. Look at the label near the pins. Some sensors have an “L” in the lower lefthand corner of this label. Other sensors do not.

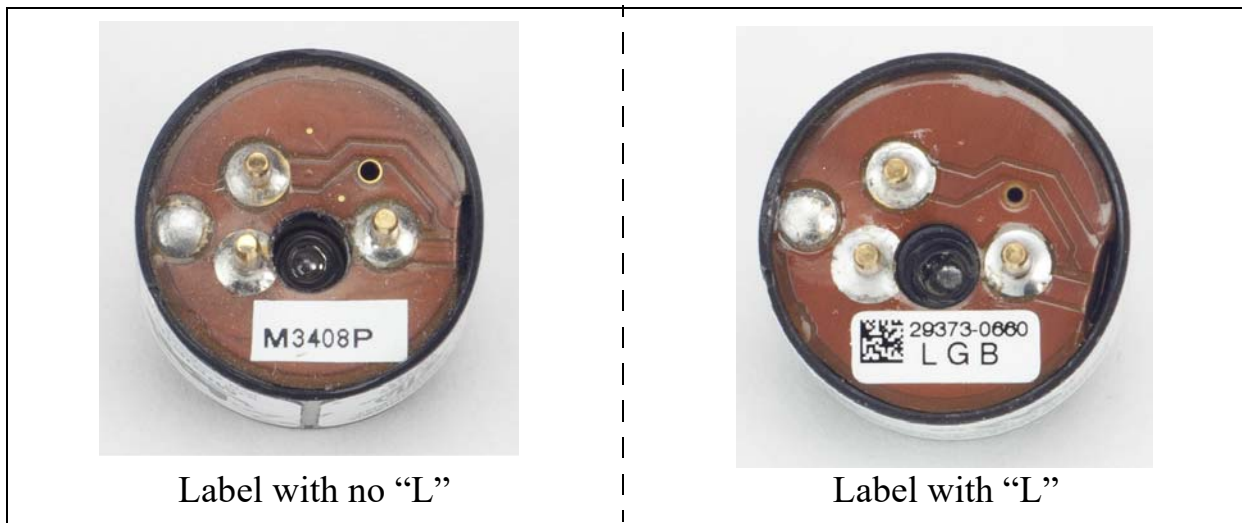

- c. See the table below for replacement lamp part numbers based on your sensor part number and the presence of the “L” on the pin label.
2. If you have a 61-0302 or 61-0303 sensor, see the table below for replacement lamp part numbers.

**Table 16: PID Sensor Replacement Lamp Part Numbers**

PID Sensor Part Number		Replacement Lamp Part Number
61-0300RK-01	No “L”	51-1500RK
	“L”	51-1503
61-0301-02	No “L”	51-1502
	“L”	51-1503
61-0302		51-1503
61-0303		51-1503

## Steps to Replace the Lamp

Perform the following procedure to replace the PID lamp:

**NOTE:** Do not touch the new lamp window (the flat end) with your fingers as this may contaminate the window with finger oil.

1. Verify that the EAGLE 2 is off.
2. Place the EAGLE 2 upside down on a flat surface or hold it upside down.
3. Unscrew the three case screws until they disengage from the top case. They are captive screws so they will not fall off of the bottom case.
4. Turn the EAGLE 2 right side up and carefully lift the top case away from the bottom case. Be careful not to lift it so far that it pulls on the main PCB with the cable that connects the top case to the main PCB.
5. Lay the top case down next to the bottom case to allow access to the flow system.
6. Locate the PID sensor adapter. It has a five wire cable and is normally located next to the pump. The cable has a connector that mates to a PID sub PCB that is installed on the main PCB. Figure 27 on page 126 shows a PID sensor in a typical location.
7. Grasp the sensor adapter firmly and pull it out of the PID flow chamber. Rock it back and forth gently if necessary to pull it out. Take care not to pull the cable connector from the PID sub PCB.
8. The PID sensor protrudes from one end of the sensor adapter. Grasp the PID sensor firmly and pull it out of the sensor adapter.
9. Place the PID sensor face down on a flat clean working surface.
10. Hold the PID sensor steady on the working surface with one hand and using the other hand, locate the tabs on the electrode stack removal tool and insert them into the slots on the side of the PID sensor near the face.

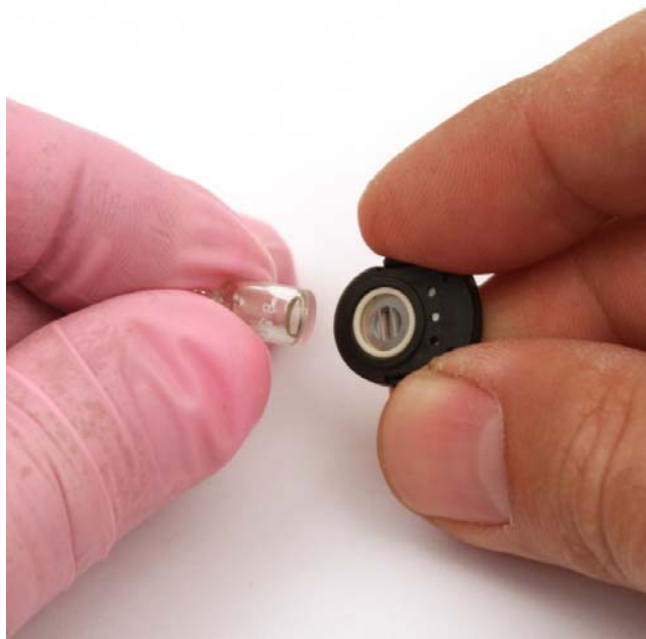

**Figure 33: Using Removal Tool**

11. Squeeze the removal tool to push the tabs into the sensor slots until the electrode stack and lamp are released.
12. Carefully lift the PID sensor body away from the electrode stack and lamp. If the lamp remains lodged in the sensor body, carefully remove it with tweezers.
13. If the spring in the lamp cavity comes out, place it back into the lamp cavity.
14. Discard the old PID lamp.

**NOTE:** At this point it is recommended that the finger cots be used on the fingers handling the lamp. Finger cots are included with the lamp cleaning kit.

15. Hold the electrode stack between the thumb and forefinger of one hand and place the window end of the new lamp inside the O-ring seal in the electrode stack with the other hand as shown below. Take care not to touch the lamp window.



**Figure 34: Reinstalling the Electrode Lamp**

16. Twisting the lamp slightly during insertion will help to ensure the lamp window is snug against the stack's front electrode. The lamp should be supported by the O-ring.
17. Continuing to hold the electrode stack between your forefinger and thumb, carefully insert the lamp into the lamp cavity in the sensor ensuring that the lamp remains in position.
18. Press in the electrode stack firmly to ensure that the stack wing clips are engaged and the faces of the stack and sensor body are flush.
19. Carefully line up the PID sensor's pins with the sockets in the bottom of the sensor adapter and gently lower the sensor into the adapter until you feel it contact the bottom.
20. Do not attempt to push the sensor in farther once it makes contact with the bottom of the adapter until you are sure that the sensor's pins are engaged with the sockets. If you feel that the pins did not engage the sockets, slightly rotate the sensor back and forth without putting pressure on it until you feel the pins engage the sockets.

21. Push the sensor into the sockets until it bottoms out.
22. Insert the sensor adapter into the PID flow chamber and push it in until it bottoms out.
23. Confirm that the main PCB is seated in its slots and that its bottom edge is resting on the bottom of the bottom case. If the main PCB is not seated properly, it may be damaged when the top case is re-installed.
24. Make sure that the top case gasket is fully seated in its groove and carefully put the top case back on the bottom case. If you have any difficulty mating the top and bottom cases, inspect the placement of the main PCB and the placement of the top case gasket.
25. Turn the EAGLE 2 upside down and tighten the three case screws to secure the top case to the bottom case.
26. Calibrate the PID channel as described in “PID Calibration” on page 131.

## Replacing the Electrode Stack

The electrode stack can last for the life of the PID sensor if the EAGLE 2 is used in a very clean, controlled environment. When used in a heavily contaminated or dirty environment, the electrode stack may only last a month. A contaminated electrode stack will cause a drop in sensitivity which can cause problems calibrating the PID channel. The electrode stack should be replaced if the PID sensor shows signs of contamination even after cleaning or replacing the lamp.

**NOTE:** Do not touch the new lamp window (the flat end) with your fingers as this may contaminate the window with finger oil.

1. Verify that the EAGLE 2 is off.
2. Place the EAGLE 2 upside down on a flat surface or hold it upside down.
3. Unscrew the three case screws until they disengage from the top case. They are captive screws so they will not fall off of the bottom case.
4. Turn the EAGLE 2 right side up and carefully lift the top case away from the bottom case. Be careful not to lift it so far that it pulls on the main PCB with the cable that connects the top case to the main PCB.
5. Lay the top case down next to the bottom case to allow access to the flow system.
6. Locate the PID sensor adapter. It has a five wire cable and is normally located next to the pump. The cable has a connector that mates to a PID sub PCB that is installed on the main PCB. Figure 27 on page 126 shows a PID sensor in a typical location.
7. Grasp the sensor adapter firmly and pull it out of the PID flow chamber. Rock it back and forth gently if necessary to pull it out. Take care not to pull the cable connector from the PID sub PCB.
8. The PID sensor protrudes from one end of the sensor adapter. Grasp the PID sensor firmly and pull it out of the sensor adapter.
9. Place the PID sensor face down on a flat clean working surface.

**NOTE:** At this point it is recommended that the finger cots be used on the fingers handling the lamp. Finger cots are included with the lamp cleaning kit.

10. Hold the PID sensor steady on the working surface with one hand and using the other hand, locate the tabs on the electrode stack removal tool and insert them into the slots on the side of the PID sensor near the face.



**Figure 35: Using Removal Tool**

11. Squeeze the removal tool to push the tabs into the sensor slots until the electrode stack and lamp are released.
12. Carefully lift the PID sensor body away from the electrode stack and lamp. If the lamp remains lodged in the sensor body, carefully remove it with tweezers.
13. If the spring in the lamp cavity comes out, place it back into the lamp cavity.
14. Discard the old electrode stack.
15. Hold the new electrode stack between the thumb and forefinger of one hand and place the window end of the lamp inside the O-ring seal in the new electrode stack with the other hand as shown below. Take care not to touch the lamp window.

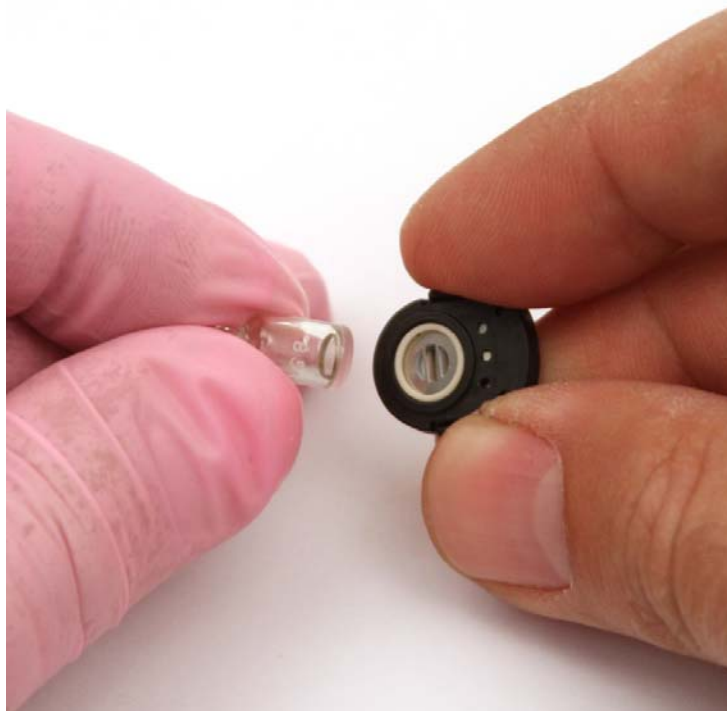

**Figure 36: Reinstalling Electrode Lamp**

16. Twisting the lamp slightly during insertion will help to ensure the lamp window is snug against the stack's front electrode. The lamp should be supported by the O-ring.
17. Continuing to hold the electrode stack between your forefinger and thumb, carefully insert the lamp into the lamp cavity in the sensor ensuring that the lamp remains in position.
18. Press in the electrode stack firmly to ensure that the stack wing clips are engaged and the faces of the stack and sensor body are flush.
19. Carefully line up the PID sensor's pins with the sockets in the bottom of the sensor adapter and gently lower the sensor into the adapter until you feel it contact the bottom.
20. Do not attempt to push the sensor in farther once it makes contact with the bottom of the adapter until you are sure that the sensor's pins are engaged with the sockets. If you feel that the pins did not engage the sockets, slightly rotate the sensor back and forth without putting pressure on it until you feel the pins engage the sockets.
21. Push the sensor into the sockets until it bottoms out.
22. Insert the sensor adapter into the PID flow chamber and push it in until it bottoms out.
23. Confirm that the main PCB is seated in its slots and that its bottom edge is resting on the bottom of the bottom case. If the main PCB is not seated properly, it may be damaged when the top case is re-installed.
24. Make sure that the top case gasket is fully seated in its groove and carefully put the top case back on the bottom case. If you have any difficulty mating the top and bottom cases, inspect the placement of the main PCB and the placement of the top case gasket.
25. Turn the EAGLE 2 upside down and tighten the three case screws to secure the top case to the bottom case.

26. Calibrate the PID channel as described in “PID Calibration” on page 131.

## Replacing the PID Sensor

1. Verify that the EAGLE 2 is off.
2. Place the EAGLE 2 upside down on a flat surface or hold it upside down.
3. Unscrew the three case screws until they disengage from the top case. They are captive screws so they will not fall off of the bottom case.
4. Turn the EAGLE 2 right side up and carefully lift the top case away from the bottom case. Be careful not to lift it so far that it pulls on the main PCB with the cable that connects the top case to the main PCB.
5. Lay the top case down next to the bottom case to allow access to the flow system.
6. Locate the PID sensor adapter. It has a five wire cable and is normally located next to the pump. The cable has a connector that mates to a PID sub PCB that is installed on the main PCB. Figure 27 on page 126 shows a PID sensor in a typical location.
7. Grasp the sensor adapter firmly and pull it out of the PID flow chamber. Rock it back and forth gently if necessary to pull it out. Take care not to pull the cable connector from the PID sub PCB.
8. The PID sensor protrudes from one end of the sensor adapter. Grasp the old PID sensor firmly and pull it out of the sensor adapter.
9. Carefully line up the new PID sensor’s pins with the sockets in the bottom of the sensor adapter and gently lower the sensor into the adapter until you feel it contact the bottom.
10. Do not attempt to push the sensor in farther once it makes contact with the bottom of the adapter until you are sure that the sensor’s pins are engaged with the sockets. If you feel that the pins did not engage the sockets, slightly rotate the sensor back and forth without putting pressure on it until you feel the pins engage the sockets.
11. Push the sensor into the sockets until it bottoms out.
12. Insert the sensor adapter into the PID flow chamber and push it in until it bottoms out.
13. Plug the PID cable connector into the PID sub PCB on the main PCB.
14. Confirm that the main PCB is seated in its slots and that its bottom edge is resting on the bottom of the bottom case. If the main PCB is not seated properly, it may be damaged when the top case is re-installed.
15. Make sure that the top case gasket is fully seated in its groove and carefully put the top case back on the bottom case. If you have any difficulty mating the top and bottom cases, inspect the placement of the main PCB and the placement of the top case gasket.
16. Turn the EAGLE 2 upside down and tighten the three case screws to secure the top case to the bottom case.
17. Calibrate the PID channel as described in “PID Calibration” on page 131.

## Configuring the PID Gas in Setup Mode

The standard PID channel is configured for and calibrated to isobutylene. If calibration to a different gas is required for an application, the PID channel can also be configured for other gases in the CONFIGURE GASES menu item in Setup Mode. To change the gas configuration of the PID channel in Setup Mode, do the following:

**WARNING:** *The EAGLE 2 is not in operation as a gas detector while in Setup Mode.*

1. Take the EAGLE 2 to a non-hazardous location and turn it off if it is on.
2. Press and hold AIR ▲ YES and RANGE ▼ SHIFT, then press and hold POWER ENTER RESET. When you hear a beep, release the buttons.
3. The LCD will show the following screen for a few seconds with the “S” in the lower right corner indicating the unit is entering Setup Mode.



4. The “S” will then disappear and the following screen will appear for a few seconds.



5. If the unit prompts you for the password, enter it by using AIR ▲ YES and RANGE ▼ SHIFT to select each password number and then pressing and releasing the POWER ENTER RESET button to enter it and move on to the next number until all of the numbers are entered. The main menu displays. It displays six menu items at a time.

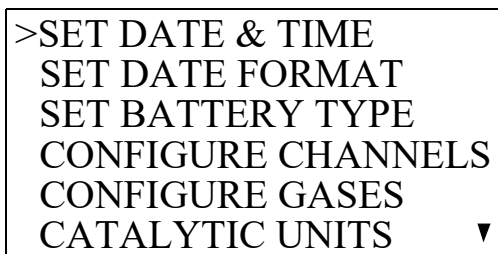

6. Use the RANGE ▼ SHIFT button to move the cursor down the menu to CONFIGURE GASES.

- Press and release POWER ENTER RESET. The Configure Gases Screen appears with the cursor flashing next to CAT, the catalytic sensor. If an EAGLE 2 has a PID sensor installed, one of the three optional sensor types, OP1, OP2, or OP3 will indicate it is a PID. In the example below, OP1 is shown as a PID sensor.

```

CONFIGURE GASES

> CAT : CH4 (CAT)
  OP1 : IBL (PID)
  OP2 : --- (---)
  OP3 : --- (---)

```

- Use RANGE ▼ SHIFT to move the cursor down the menu to the PID sensor.

```

CONFIGURE GASES

  CAT : CH4 (CAT)
> OP1 : IBL (PID)
  OP2 : --- (---)
  OP3 : --- (---)

```

- To change the PID sensor gas configuration, press and release POWER ENTER RESET.
- A screen appears that indicates the PID type, low range or high range (flashing), and the detection range for the currently configured gas. In the example below, the PID sensor is currently configured as a high range sensor for 0 - 2,000 ppm isobutylene.

```

PID(0- 2000ppm IBL )

UP/DOWN THEN ENTER

HIGH RANGE

```

- Use AIR ▲ YES and RANGE ▼ SHIFT to set the correct range, low or high, for the sensor that is installed.

Press and release POWER ENTER RESET. A screen appears with gas configuration choices for the PID sensor. The screen below illustrates the first four choices for a high range PID.

```

PID(0- 2000ppm IBL )

> 1000 ppm ACT
  1000 ppm BNZ
  1500 ppm DSL
  15000 ppm ETA

```

There are 17 choices that can be viewed on five screens. Table 17 below lists all of the gas configuration choices.

**Table 17: PID Gas Configurations**

<b>Gas Name (LCD Abbreviation)</b>	<b>Detection Range Full Scale Low Range/High Range</b>
Acetone (ACT)	30.00 ppm/1000 ppm
Benzene (BNZ)	25.00 ppm/1000 ppm
Diesel Fuel No. 1 (DSL)	40.00 ppm/1500 ppm
Ethanol (ETA)	400.0 ppm/15000 ppm
Gasoline (GSL)	50.00 ppm/2000 ppm
Isobutylene (IBL) Standard Factory Gas Configuration	50.00 ppm/2000 ppm
Isopropanol (IPA)	200.0 ppm/5000 ppm
JP-5 Fuel (JP5)	30.00 ppm/1000 ppm
Methyl Ethyl Ketone (MEK)	40.00 ppm/1500 ppm
Toluene (TOL)	25.00 ppm/1000 ppm
N-Hexane (HEX)	200.0 ppm/5000 ppm
Propylene (PRL)	50.00 ppm/2500 ppm
Styrene (STY)	20.00 ppm/500 ppm
Tetrachloroethylene (PCE)	30.00 ppm/1000 ppm
Trichloroethylene (TCE)	30.00 ppm/1000 ppm
Vinyl Chloride (VCM)	100.0 ppm/4000 ppm
PID (PID) User Defined Gas Loaded with Maintenance Program	50.0 ppm/2000 ppm

12. Use AIR ▲ YES and RANGE ▼ SHIFT to place the cursor next to the desired gas. In the example below, the cursor is placed next to isopropanol (IPA).

PID(0- 2000ppm IBL )  2000 ppm GSL 2000 ppm IBL > 5000 ppm IPA 1000 ppm JP5	▼
--	---

13. Press and release the POWER ENTER RESET button. The LCD will ask for confirmation that you want to change the configured gas.

CHANGE TO IPA ?  
PRESS YES OR NO

14. To change the gas configuration, press and release AIR ▲ YES. The unit will return to the Configure Gases Screen reflecting the new gas configuration.

CONFIGURE GASES  
CAT : CH4 (CAT)  
> OP1 : IPA (PID)  
OP2 : --- (---)  
OP3 : --- (---) ▼

If you do not want to change the gas configuration, press and release DISPLAY ADJUST NO. The unit will return to the first gas configuration choice screen with the gas configuration unchanged.

PID(0- 2000ppm IBL )  
> 1000 ppm ACT  
1000 ppm BNZ  
1500 ppm DSL  
15000 ppm ETA ▼

Select a different gas and go to Step 13 or press and release DISPLAY ADJUST NO to return to the Gas Configuration screen.

15. Use RANGE ▼ SHIFT to place the cursor next to **END**.
16. Press and release POWER ENTER RESET to return to the main menu.
17. Use RANGE ▼ SHIFT to place the cursor in front of **NORMAL OPERATION** at the bottom of the main menu.
18. Press and release POWER ENTER RESET.

19. A screen appears that asks if you want to save the changes you have made.

SAVE ALL CHANGES  
IN MEMORY?

**NOTE:** If you entered Setup Mode and did not make any changes, the above screen will still appear. In this case, press and release DISPLAY ADJUST NO to proceed to exit Setup Mode and begin the EAGLE 2's startup sequence.

20. If you do not want to save the changes, press and release DISPLAY ADJUST NO. The unit will begin its startup sequence without saving the changes.

If you do want to save the changes, press and release AIR ▲ YES and continue with the next step.

21. A confirmation screen appears asking if you are sure you want to save the changes.

ARE YOU SURE YOU  
WANT TO SAVE ALL  
CHANGES IN MEMORY?

22. If you want to save the changes, press and release AIR ▲ YES to save the changes. A screen will appear for a few seconds indicating that the changes have been saved and the unit will begin its startup sequence.

If you do not want to save the changes, press and release DISPLAY ADJUST NO to proceed to the unit's startup sequence without saving changes.

# Parts List

**Table 18: PID EAGLE 2 Spare Parts**

Part Number	Description
33-0560RK	Electrode stack, 0 - 50 ppm, 2 pack
33-0562	Electrode stack, 0 - 2,000 ppm, HPPM type
51-1500RK	Replacement lamp, 0 - 50 ppm <ul style="list-style-type: none"> <li>• for 61-0300RK-01 sensor without "L" on label</li> </ul>
51-1502	Replacement lamp, 0 - 2,000 ppm, HPPM type <ul style="list-style-type: none"> <li>• for 61-0301-02 sensor without "L" on label</li> </ul>
51-1502-01	Electrode stack/lamp set, 0 - 2,000 ppm, HPPM type <ul style="list-style-type: none"> <li>• for 61-0301-02 sensor without "L" on label</li> </ul>
51-1503	Replacement lamp <ul style="list-style-type: none"> <li>• for 61-0300RK-01 sensor with "L" on label</li> <li>• for 61-0301-02 sensor with "L" on label</li> <li>• for 61-0302 sensor</li> <li>• for 61-0303 sensor</li> </ul>
57-2005RK	Adapter assembly, for PID sensor
61-0302	PID sensor, 0 - 50 ppm VOC, improved type
61-0303	PID sensor, 0 - 2,000 ppm VOC, improved type
80-0131RK-20	PID probe, particle filter removed
80-0605RK	Teflon lined sample hose, 5 feet
80-0610RK	Teflon lined sample hose, 10 feet
80-0615RK	Teflon lined sample hose, 15 feet
80-0620RK	Teflon lined sample hose, 20 feet
81-0103RK-01	Calibration cylinder, isobutylene, 100 ppm in air, 34 liter steel
81-0103RK-03	Calibration cylinder, isobutylene, 100 ppm in air, 103 liter steel
81-0103RK-04	Calibration cylinder, isobutylene, 100 ppm in air, 34 liter aluminum
81-0104RK-01	Calibration cylinder, isobutylene, 10 ppm in air, 34 liter steel
81-0104RK-03	Calibration cylinder, isobutylene, 10 ppm in air, 103 liter steel
81-0104RK-04	Calibration cylinder, isobutylene, 10 ppm in air, 34 liter aluminum
81-0143RK-02	Calibration cylinder, 5-gas (Proprietary blend of IBL, CH <sub>4</sub> , O <sub>2</sub> , H <sub>2</sub> S, CO), 58-liter aluminum
81-0143RK-04	Calibration cylinder, 5-gas (Proprietary blend of IBL, CH <sub>4</sub> , O <sub>2</sub> , H <sub>2</sub> S, CO), 34-liter aluminum

**Table 18: PID EAGLE 2 Spare Parts**

<b>Part Number</b>	<b>Description</b>
81-1054RK	Regulator, demand-flow type (for 58- and 103-liter aluminum or steel, and 34-liter aluminum cylinder)
81-1055RK	Regulator, demand-flow type (for 17- and 34-liter steel cylinder)
82-0003RK	Electrode stack removal tool
82-0300RK	Lamp cleaning kit with electrode stack removal tool

# Appendix E: ESM-01 Toxic Sensors

## Overview

The ESM-01 sensors are used to monitor levels of a variety of toxic gases. This appendix describes the EAGLE 2's ESM-01 sensors and includes instructions to use an EAGLE 2 that has one or more ESM-01 sensors installed. It also includes instructions to replace an ESM-01 sensor.

**Table 19: ESM-01 Sensor Specifications**

Target Gas	Detection Range (ppm)	Reading Increment	Alarm 1 Factory Setting	Alarm 2 Factory Setting	STEL (ppm)	TWA (ppm)
Ammonia (NH <sub>3</sub> )	0 - 75.0	0.5 ppm	12.0 ppm	25.0 ppm	35	25
Arsine (AsH <sub>3</sub> )	0 - 1.50	0.01 ppm	0.20 ppm	0.50 ppm	OFF	OFF
Chlorine (Cl <sub>2</sub> )	0-3.00	0.02 ppm	0.50 ppm	1.50 ppm	1.00	0.50
Hydrogen Cyanide (HCN)	0 - 15.0	0.1 ppm	3.00 ppm	5.00 ppm	4.7	OFF
Phosphine (PH <sub>3</sub> )	0 - 1.00	0.01 ppm	0.10 ppm	0.30 ppm	1.00	0.30
Sulphur Dioxide (SO <sub>2</sub> )	0 - 6.00	0.05 ppm	1.00 ppm	2.00 ppm	1.00	0.50

## Description

Table 19 above lists the available ESM-01 sensors. The ESM-01 is a smart sensor that stores sensor parameters including the target gas, detection range, alarm points, and calibration settings in its memory. So a sensor can be calibrated at the factory and shipped as a replacement sensor without the need to calibrate the sensor when it is installed as long as it is installed during the sensor's valid calibration period which is typically 3 months. In addition, you can change an existing ESM-01 channel from one type of ESM-01 sensor to another and the EAGLE 2 will automatically load all the sensor parameters and configure the ESM-01 channel for the new sensor without the need to enter CONFIGURE CHANNELS or CONFIGURE GASES in Setup Mode. See "Replacing the ESM-01 Sensor or Changing Sensor Type" on page 180 for instructions to replace or change an ESM-01 sensor.

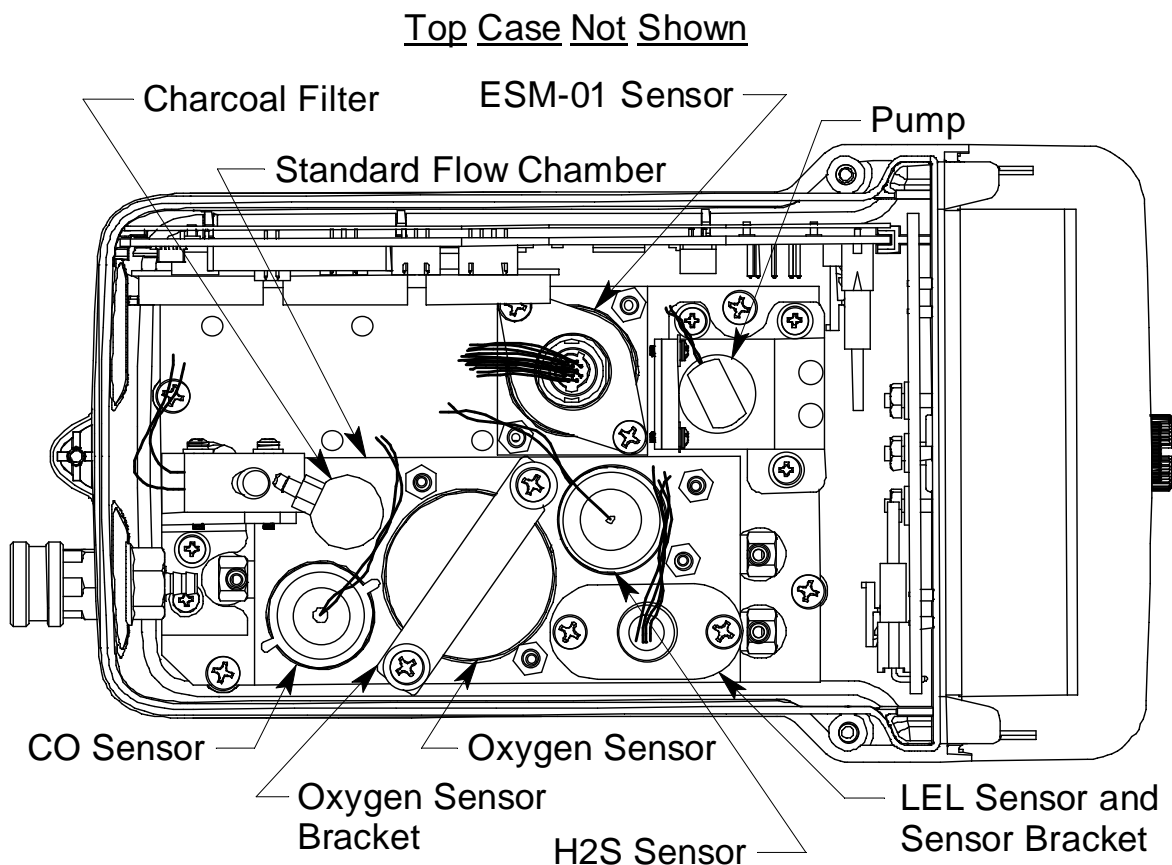

**Figure 37: Typical ESM-01 Sensor Location**

The ESM-01 sensor is installed in a single sensor flow chamber which is located in the area next to the standard 4-sensor flow chamber. This area can accommodate up to three single sensor flow chambers. Although the EAGLE 2 can support up to three ESM-01 sensors, many combinations are impractical for various reasons including sensor cross sensitivity to other gases. Consult RKI Instruments, Inc. for practical combinations. Figure 37 above illustrates a typical ESM-01 sensor location in front of the pump. The ESM-01 flow chamber may also be installed in one of the other two sensor chamber locations depending on the particular version of the EAGLE 2. Some ESM-01 instrument configurations do not include the 4-sensor flow chamber.

### **ESM-01 Sensor**

The ESM-01 sensor is a cylindrical sensor with a diffusion opening on the front and a 12 pin circular connector on the back. A 12 wire cable plugs into the back of the ESM-01 sensor with a circular connector that includes a locking lever. The other end of the cable plugs into an ESM-01 sub PCB (see description below) that is installed on the main PCB. The sensor is held in the ESM-01 flow chamber by a bracket on standoffs.

### **ESM-01 Sub PCB**

The ESM-01 sub PCB is a circuit board that is installed on the main PCB in one of the 3 sub PCB positions when an ESM-01 sensor is used with the EAGLE 2. The ESM-01 sensor connects to the sub PCB with a 12-position connector. The sub PCB plugs into the main PCB and is held in place with a screw/flat washer/lock washer. There are no user serviceable parts on the ESM-01 sub PCB.

---

## Start Up and Normal Operation

For instructions to startup and use an EAGLE 2 that includes an ESM-01 sensor, reference “Start Up” on page 27, “Measuring Mode, Normal Operation” on page 33, and “Measuring Mode, Alarms” on page 38. Follow these instructions keeping the following special considerations in mind:

- Several of the gases that can be monitored with an ESM-01 are absorbed in the longer EAGLE 2 sample hoses. Do not use sample hoses that are longer than the standard 5 foot hose without consulting RKI Instruments, Inc.
- If your EAGLE 2 has more than one ESM-01 sensor installed, it is possible that both sensors will respond to some of the same gases at varying levels. Make sure you understand any issues like this that may exist in your particular instrument.
- The SO<sub>2</sub> and HCN ESM-01 sensors include a replaceable H<sub>2</sub>S scrubber disk inside the sensor face. The SO<sub>2</sub> and HCN sensors respond to H<sub>2</sub>S, so the H<sub>2</sub>S scrubber disk removes H<sub>2</sub>S from the sample to avoid false SO<sub>2</sub> and HCN readings. See “Replacing the H<sub>2</sub>S Scrubber in the SO<sub>2</sub> and HCN Sensors” on page 181 for instructions to replace the H<sub>2</sub>S scrubber.

---

## ESM-01 Calibration

An ESM-01 channel can be calibrated using the auto calibration method or the single calibration method. To calibrate an ESM-01 channel using the single calibration method, see “Calibrating Using the Single Calibration Method” on page 62 and follow the instructions for calibrating a single channel. If your instrument is a multi-channel instrument that includes one or more ESM-01 channels, RKI Instruments, Inc. recommends using the auto calibration method for convenience. There are two ways to calibrate an EAGLE 2 with an ESM-01 channel installed. The first way, described below in “Calibrating with a 4-Gas Cylinder and an ESM-01 Cylinder” on page 166, uses a 4-gas cylinder and an IBL cylinder. The second way, described below in “Calibrating with a 5-Gas Cylinder” on page 174, uses a multi-gas cylinder that contains the target gas for all installed sensors. Follow the set of instructions appropriate for your cylinder configuration.

**NOTE:** If your instrument has more than one ESM-01 sensor, you will need a calibration cylinder for each sensor and follow the instructions in “Calibrating with a 4-Gas Cylinder and an ESM-01 Cylinder” on page 166.

### Calibrating with a 4-Gas Cylinder and an ESM-01 Cylinder

The calibration instructions below show a 5 channel instrument which has the four standard channels, LEL/oxygen/H<sub>2</sub>S/CO, and an ESM-01 channel for ammonia (NH<sub>3</sub>).

1. See “Calibration Supplies and Equipment” on page 55 for a description of the necessary calibration supplies. In addition to an appropriate multi-gas cylinder that is used to calibrate any active standard channels, you will also need a cylinder to calibrate the ESM-01 channel. See Table 20 on page 183 for available cylinders. Make sure your calibration cylinder is appropriate for the ESM-01 detection range.

**WARNING:** *RKI Instruments, Inc. recommends that you dedicate a regulator for use with chlorine (Cl<sub>2</sub>) gas and that you do not use that dedicated regulator for any other gases, particularly hydrogen sulfide (H<sub>2</sub>S).*

2. Find a fresh-air environment. This is an environment free of toxic or combustible gases and of normal oxygen content (20.9%).
3. While in Measuring Mode, press and hold the RANGE ▼ SHIFT button, then press the DISPLAY ADJUST NO button and release both buttons.
4. If the unit prompts you for the password, enter it by using the AIR ▲ YES and RANGE ▼ SHIFT buttons to select each password number and then pressing and releasing POWER ENTER RESET to enter the number and move on to the next one.
5. The Calibration Mode Screen displays with the cursor next to **AUTO CALIBRATION**.

```
CALIBRATION MODE
> AUTO CALIBRATION
  SINGLE CALIBRATION
  PERFORM AIR ADJUST
  NORMAL OPERATION
```

6. Move the cursor to the **PERFORM AIR ADJUST** menu item by using the RANGE ▼ SHIFT button.

```
CALIBRATION MODE

  AUTO CALIBRATION
  SINGLE CALIBRATION
> PERFORM AIR ADJUST
  NORMAL OPERATION
```

7. Press and release the POWER ENTER RESET button. The following screen appears.

```
PERFORM

AIR ADJUST?
```

8. Press and release the AIR ▲ YES button to continue. If you do not want to continue, press the DISPLAY ADJUST NO button and the unit will return to the Calibration Mode Screen.

9. The EAGLE 2 will indicate that it is adjusting the zero reading for a few seconds, then indicate that the operation is complete before returning to the Calibration Mode Screen.

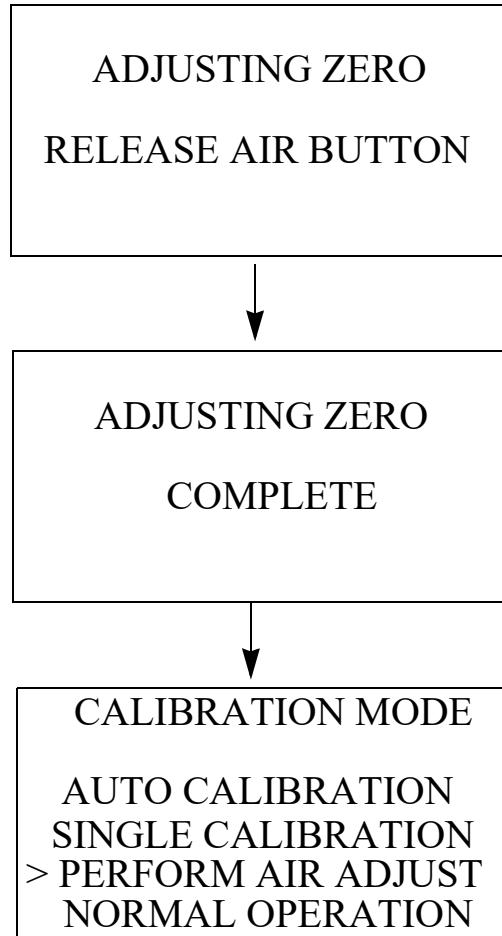

10. Install the demand flow regulator onto the multi-gas calibration cylinder.
11. Connect the sample tubing to the demand flow regulator.
12. Install the probe on the EAGLE 2 inlet fitting. Make sure the probe is complete with internal O-ring and membrane and that the two halves of the probe are tightened firmly together to avoid leaks that can affect the calibration. See Figure 21 on page 72 for an illustration of the internal parts of the probe.
13. Move the cursor next to the **AUTO CALIBRATION** menu item by using the AIR ▲ YES button.

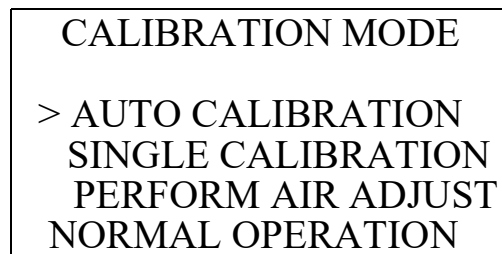

14. Press and release the POWER ENTER RESET button to display the Calibration Gas Values Screen.

CAL GAS VALUES		
CH4	50	%LEL
OXY	12.0	vol%
H2S	25.0	ppm
CO	50	ppm
ENTER TO BEGIN CAL		

The gas concentrations displayed in the Calibration Gas Values Screen must match the gas concentrations listed on the 4-gas calibration cylinder.

If *all* concentrations match, go to Step 25.

If *one or more* concentrations *do not* match, continue with Step 15.

If you do not want to continue with the calibration, press and release the DISPLAY ADJUST NO button to return to the Calibration Mode Screen.

**NOTE:** The RKI 4-gas cylinder typically contains 12% O<sub>2</sub> by volume. When using the auto calibration method, be sure to set the “OXY” auto calibration value to agree with the concentration listed on the cylinder’s label, not zero.

15. To adjust the values on the screen, press and hold the RANGE ▼ SHIFT button, then press the DISPLAY ADJUST NO button and release both. The following screen appears with the cursor next to **CH4**.

ADJUST AUTO CALIBRATION VALUES		
> CH4	50	%LEL
OXY	12.0	vol%
H2S	25.0	ppm
CO	50	ppm ▼

16. Place the cursor next to the channel whose gas value you want to change using the AIR ▲ YES and RANGE ▼ SHIFT buttons.
17. Press and release the POWER ENTER RESET button to select the channel. The calibration gas value begins to flash.
18. Use the AIR ▲ YES and RANGE ▼ SHIFT buttons to adjust the calibration gas setting to the desired value.

**NOTE:** The calibration gas value cannot be set lower than the low alarm setting. If the calibration gas value listed on the calibration cylinder is lower than the current low alarm setting, enter Setup Mode and change the low alarm setting. See “Updating the Alarm Point Settings” on page 106 for instructions. If you need to change the alarm point setting only to perform a calibration, make sure that you change the alarm point setting back to its original value once the calibration has been performed.

19. Press and release the POWER ENTER RESET button to save the change. The calibration gas value stops flashing.
20. Repeat Step 16 through Step 19 for any other channels that need to be changed.

21. When you are done adjusting the calibration gas values, move the cursor down past the bottom of the screen next to **END**.

```
ADJUST AUTO
CALIBRATION VALUES
> END ▲
```

22. Press and release the POWER ENTER RESET button. The following screen appears.

```
DO YOU WANT TO
STORE NEW VALUE(S)
IN MEMORY FOR
FUTURE CALIBRATIONS?

PRESS YES OR NO
```

23. If you select YES by pressing and releasing the AIR ▲ YES button, the changes that you made will be saved in the EAGLE 2's memory as the new auto calibration gas values.

If you select NO by pressing and releasing the DISPLAY ADJUST NO button, the changes you made will be used for any calibrations performed during the current operating session only. The EAGLE 2 will delete the changes when the unit is turned off and will load the previous set of auto calibration values when it is turned on again.

24. When you make your selection and press the desired button, the unit returns to the Calibration Gas Values Screen.

```
CAL GAS VALUES
CH4 50 %LEL
OXY 12.0 vol%
H2S 25.0 ppm
CO 50 ppm
ENTER TO BEGIN CAL
```

25. Press and release the POWER ENTER RESET button to proceed to the Calibration In Process Screen with **CAL IN PROCESS** flashing.

```
CAL IN PROCESS
CH4 0 %LEL
OXY 20.9 vol%
H2S 0.0 ppm
CO 0 ppm
ENTER WHEN DONE
```

If you do not want to proceed with the calibration, press and release the DISPLAY ADJUST NO button to return to the Cal Gas Values Screen.

If you do want to continue with the calibration, proceed to the next step.

26. Connect the tubing from the demand flow regulator to the rigid tube on the probe. Allow the EAGLE 2 to draw gas for one minute.
27. Press and release the POWER ENTER RESET button to set the span adjustment for each channel to the programmed values.
28. If all channels passed calibration, the following screen sequence occurs.

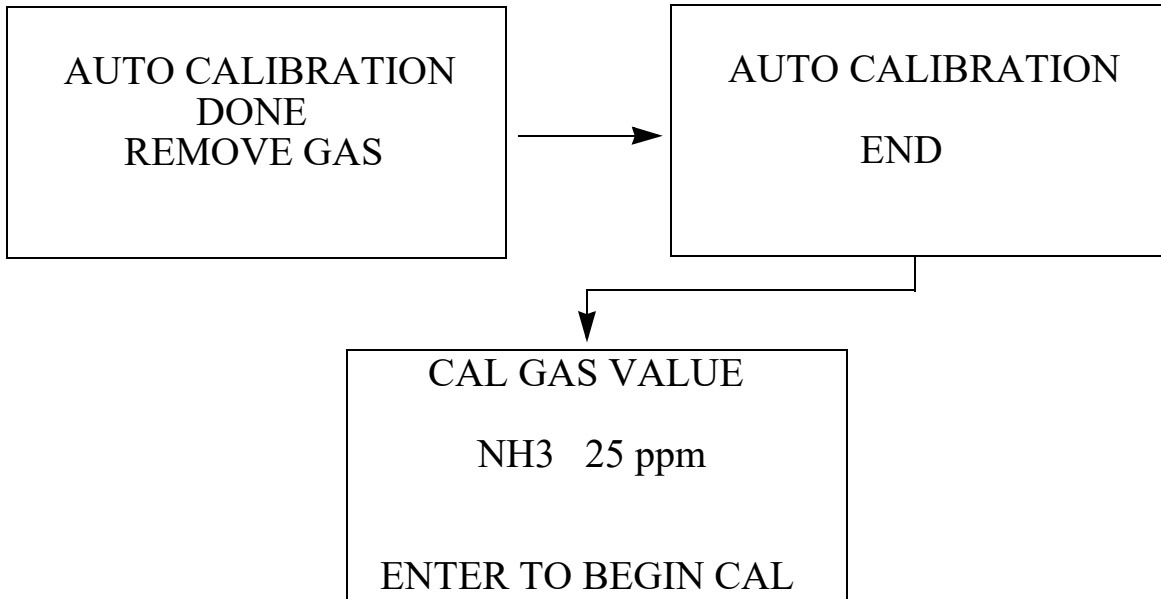

If any of the sensors cannot be adjusted to the proper value, a screen displays that indicates a calibration failure and lists the sensor(s) that failed to calibrate. In the example below, the oxygen and H<sub>2</sub>S channels failed calibration. The other sensors calibrated normally.

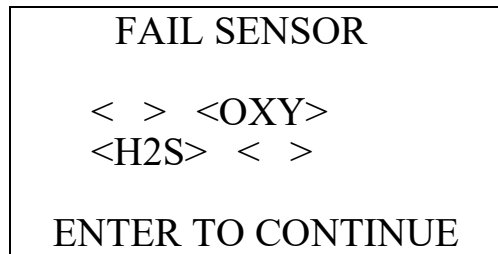

The buzzer and alarm LEDs activate in a double pulsing pattern. Press and release the POWER ENTER RESET button to reset the alarm and continue to the Calibration Value Screen for the ESM-01 channel. After calibrating the ESM-01 channel by following the instructions below, attempt to calibrate the standard channels again. If the failure continues, investigate the cause. See “Troubleshooting” on page 67.

29. Remove the tubing from the rigid tube on the probe.
30. Unscrew the 4-gas cylinder from the demand flow regulator.

31. If you want to change the ESM-01 channel's calibration gas value, follow Step 15 - Step 24 above beginning with the ESM-01 Calibration Gas Value Screen below instead of the standard channel Calibration Gas Value Screen.

CAL GAS VALUE  
NH3 25 ppm  
ENTER TO BEGIN CAL

32. With the ESM-01 Calibration Gas Value Screen displayed, press and release the POWER ENTER RESET button to proceed to the Calibration In Process Screen for the ESM-01 channel with **CAL IN PROCESS** flashing.

CAL IN PROCESS  
NH3 0 ppm  
ENTER WHEN DONE

If you do not want to proceed with the calibration, press and release the DISPLAY ADJUST NO button to return to the ESM-01 Cal Gas Values Screen.

If you do want to continue with the calibration, proceed to the next step.

33. Screw the ESM-01 calibration cylinder onto the demand flow regulator.
34. Connect the tubing from the regulator to the rigid tube on the probe. Allow the EAGLE 2 to draw gas for two minutes. If you notice that the gas reading stabilizes sooner, you can reduce the gas application time to the time it takes the gas reading to stabilize.
35. Press and release the POWER ENTER RESET button to set the span adjustment for the ESM-01 channel to the programmed value.

36. If the ESM-01 channel passed calibration, the following screen sequence occurs.

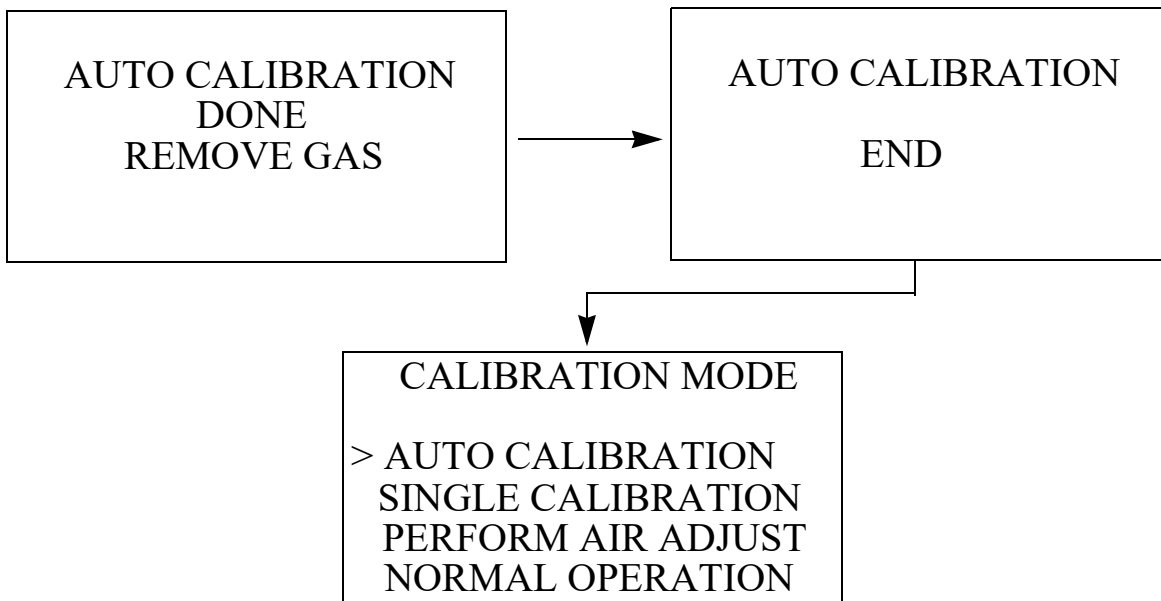

If the ESM-01 channel cannot be adjusted to the proper value, a screen displays that indicates a calibration failure and indicates that the ESM-01 sensor failed to calibrate.

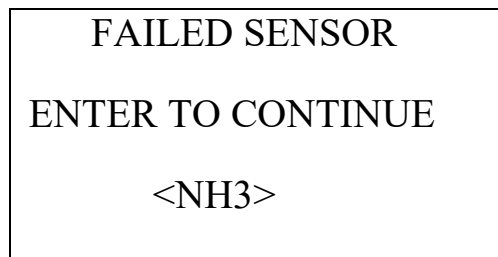

The buzzer and alarm LEDs activate in a double pulsing pattern. Press and release the POWER ENTER RESET button to reset the alarm and continue to the Calibration Mode Screen. Attempt to calibrate the ESM-01 channel again. If the failure continues, investigate the cause. See "Troubleshooting" on page 67.

37. Disconnect the tubing from the probe.
38. Unscrew the demand flow regulator from the calibration cylinder.
39. Use the RANGE ▼ SHIFT button to place the cursor next to the **NORMAL OPERATION** menu option, then press and release the POWER ENTER RESET button to return to Measuring Mode.

## Calibrating with a 5-Gas Cylinder

The calibration instructions below show a 5 channel instrument which has the four standard channels, LEL/oxygen/H<sub>2</sub>S/CO, and an ESM-01 channel for sulfur dioxide (SO<sub>2</sub>).

1. See “Calibration Supplies and Equipment” on page 55 for a description of the necessary calibration supplies. See Table 20 on page 183 for available cylinders. Make sure your calibration cylinder is appropriate for the ESM-01 detection range.

**WARNING:** *RKI Instruments, Inc. recommends that you dedicate a regulator for use with chlorine (Cl<sub>2</sub>) gas and that you do not use that dedicated regulator for any other gases, particularly hydrogen sulfide (H<sub>2</sub>S).*

2. Find a fresh-air environment. This is an environment free of toxic or combustible gases and of normal oxygen content (20.9%).
3. While in Measuring Mode, press and hold the RANGE ▼ SHIFT button, then press the DISPLAY ADJUST NO button and release both buttons.
4. If the unit prompts you for the password, enter it by using the AIR ▲ YES and RANGE ▼ SHIFT buttons to select each password number and then pressing and releasing POWER ENTER RESET to enter the number and move on to the next one.
5. The Calibration Mode Screen displays with the cursor next to **AUTO CALIBRATION**.

```
CALIBRATION MODE
> AUTO CALIBRATION
  SINGLE CALIBRATION
  PERFORM AIR ADJUST
  NORMAL OPERATION
```

6. Move the cursor to the **PERFORM AIR ADJUST** menu item by using the RANGE ▼ SHIFT button.

```
CALIBRATION MODE

  AUTO CALIBRATION
  SINGLE CALIBRATION
  > PERFORM AIR ADJUST
  NORMAL OPERATION
```

7. Press and release the POWER ENTER RESET button. The following screen appears.

```
PERFORM

AIR ADJUST?
```

8. Press and release the AIR ▲ YES button to continue.  
If you do not want to continue, press the DISPLAY ADJUST NO button and the unit will return to the Calibration Mode Screen.
9. The EAGLE 2 will indicate that it is adjusting the zero reading for a few seconds, then indicate that the operation is complete before returning to the Calibration Mode Screen.

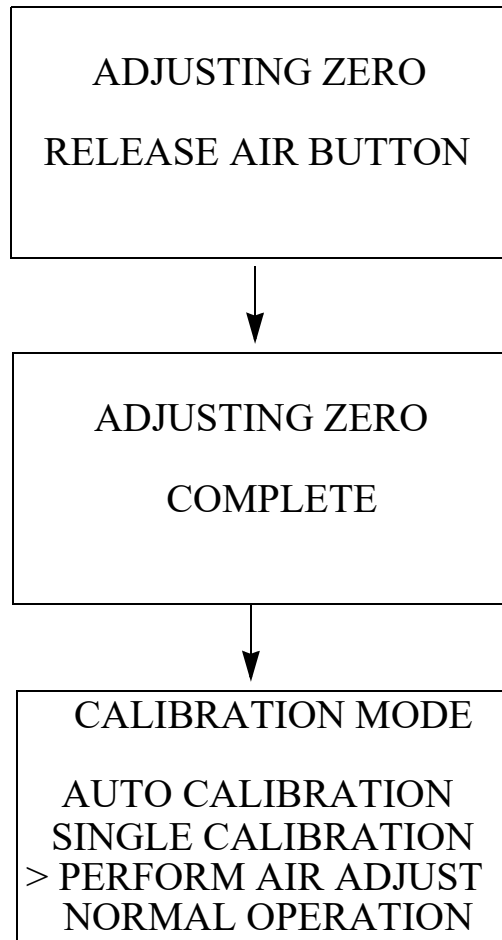

10. Install the demand flow regulator onto the multi-gas calibration cylinder.
11. Connect the sample tubing to the demand flow regulator.
12. Install the probe on the EAGLE 2 inlet fitting. Make sure the probe is complete with internal O-ring and membrane and that the two halves of the probe are tightened firmly together to avoid leaks that can affect the calibration. See Figure 21 on page 72 for an illustration of the internal parts of the probe.
13. Move the cursor next to the **AUTO CALIBRATION** menu item by using the AIR ▲ YES button.

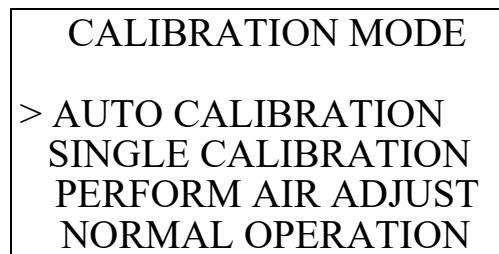

14. Press and release the POWER ENTER RESET button to display the Calibration Gas Values Screen.

CAL GAS VALUES		
CH4	50	%LEL
OXY	12.0	vol%
H2S	25.0	ppm
CO	50	ppm
ENTER TO BEGIN CAL		

The gas concentrations displayed in the Calibration Gas Values Screen must match the gas concentrations listed on the 4-gas calibration cylinder.

If *all* concentrations match, go to Step 25.

If *one or more* concentrations *do not* match, continue with Step 15.

If you do not want to continue with the calibration, press and release the DISPLAY ADJUST NO button to return to the Calibration Mode Screen.

**NOTE:** The RKI 4-gas cylinder typically contains 12% O<sub>2</sub> by volume. When using the auto calibration method, be sure to set the “OXY” auto calibration value to agree with the concentration listed on the cylinder’s label, not zero.

15. To adjust the values on the screen, press and hold the RANGE ▼ SHIFT button, then press the DISPLAY ADJUST NO button and release both. The following screen appears with the cursor next to **CH4**.

ADJUST AUTO CALIBRATION VALUES		
> CH4	50	%LEL
OXY	12.0	vol%
H2S	25.0	ppm
CO	50	ppm ▼

16. Place the cursor next to the channel whose gas value you want to change using the AIR ▲ YES and RANGE ▼ SHIFT buttons.
17. Press and release the POWER ENTER RESET button to select the channel. The calibration gas value begins to flash.
18. Use the AIR ▲ YES and RANGE ▼ SHIFT buttons to adjust the calibration gas setting to the desired value.

**NOTE:** The calibration gas value cannot be set lower than the low alarm setting. If the calibration gas value listed on the calibration cylinder is lower than the current low alarm setting, enter Setup Mode and change the low alarm setting. See “Updating the Alarm Point Settings” on page 106 for instructions. If you need to change the alarm point setting only to perform a calibration, make sure that you change the alarm point setting back to its original value once the calibration has been performed.

19. Press and release the POWER ENTER RESET button to save the change. The calibration gas value stops flashing.
20. Repeat Step 16 through Step 19 for any other channels that need to be changed.

21. When you are done adjusting the calibration gas values, move the cursor down past the bottom of the screen next to **END**.

```
ADJUST AUTO
CALIBRATION VALUES
> END ▲
```

22. Press and release the POWER ENTER RESET button. The following screen appears.

```
DO YOU WANT TO
STORE NEW VALUE(S)
IN MEMORY FOR
FUTURE CALIBRATIONS?

PRESS YES OR NO
```

23. If you select YES by pressing and releasing the AIR ▲ YES button, the changes that you made will be saved in the EAGLE 2's memory as the new auto calibration gas values.

If you select NO by pressing and releasing the DISPLAY ADJUST NO button, the changes you made will be used for any calibrations performed during the current operating session only. The EAGLE 2 will delete the changes when the unit is turned off and will load the previous set of auto calibration values when it is turned on again.

24. When you make your selection and press the desired button, the unit returns to the Calibration Gas Values Screen.

```
CAL GAS VALUES
CH4  50 %LEL
OXY  12.0 vol%
H2S  25.0 ppm
CO   50 ppm
ENTER TO BEGIN CAL
```

25. Press and release the POWER ENTER RESET button to proceed to the Calibration In Process Screen with **CAL IN PROCESS** flashing.

```
CAL IN PROCESS
CH4    0 %LEL
OXY  20.9 vol%
H2S   0.0 ppm
CO    0 ppm
ENTER WHEN DONE
```

If you do not want to proceed with the calibration, press and release the DISPLAY ADJUST NO button to return to the Cal Gas Values Screen.

If you do want to continue with the calibration, proceed to the next step.

26. Connect the tubing from the demand flow regulator to the rigid tube on the probe. Allow the EAGLE 2 to draw gas for one minute.
27. Press and release the POWER ENTER RESET button to set the span adjustment for each channel to the programmed values.
28. If all channels passed calibration, the following screen sequence occurs.

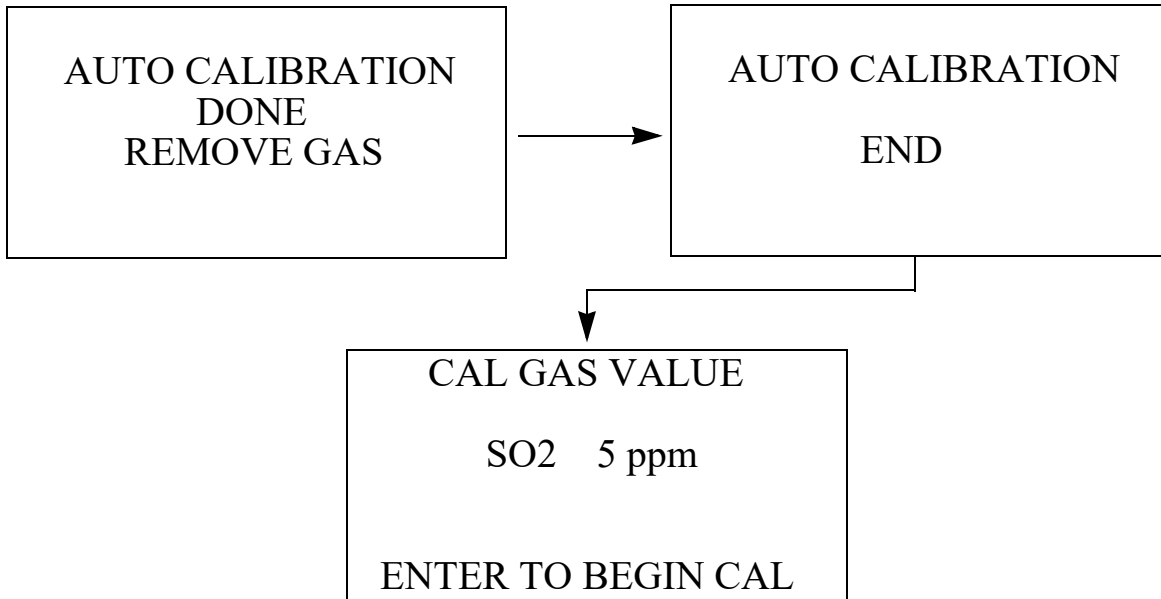

If any of the sensors cannot be adjusted to the proper value, a screen displays that indicates a calibration failure and lists the sensor(s) that failed to calibrate. In the example below, the oxygen and H<sub>2</sub>S channels failed calibration. The other sensors calibrated normally.

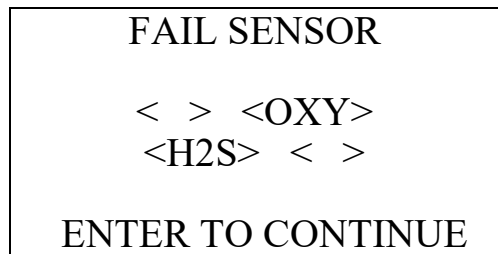

The buzzer and alarm LEDs activate in a double pulsing pattern. Press and release the POWER ENTER RESET button to reset the alarm and continue to the Calibration Value Screen for the ESM-01 channel. After calibrating the ESM-01 channel by following the instructions below, attempt to calibrate the standard channels again. If the failure continues, investigate the cause. See “Troubleshooting” on page 67.

29. If you want to change the ESM-01 channel’s calibration gas value, follow Step 15 - Step 24 above beginning with the ESM-01 Calibration Gas Value Screen below instead of the standard channel Calibration Gas Value Screen.

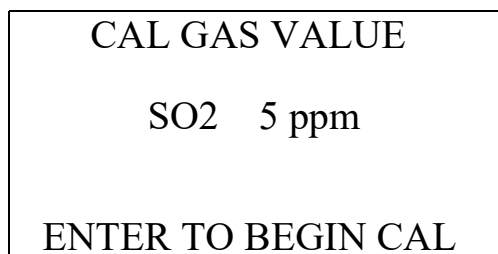

30. With the ESM-01 Calibration Gas Value Screen displayed, press and release the POWER ENTER RESET button to proceed to the Calibration In Process Screen for the ESM-01 channel with **CAL IN PROCESS** flashing.

CAL IN PROCESS  
  
SO2 3 ppm  
  
ENTER WHEN DONE

If you do not want to proceed with the calibration, press and release the DISPLAY ADJUST NO button to return to the ESM-01 Cal Gas Values Screen.

If you do want to continue with the calibration, proceed to the next step.

31. Since calibration gas has already been flowing to the ESM-01 sensor while the other channels were being calibrated, the ESM-01 sensor reading should be stable and ready for adjustment.
32. Press and release the POWER ENTER RESET button to set the span adjustment for the ESM-01 channel to the programmed value.
33. If the ESM-01 channel passed calibration, the following screen sequence occurs.

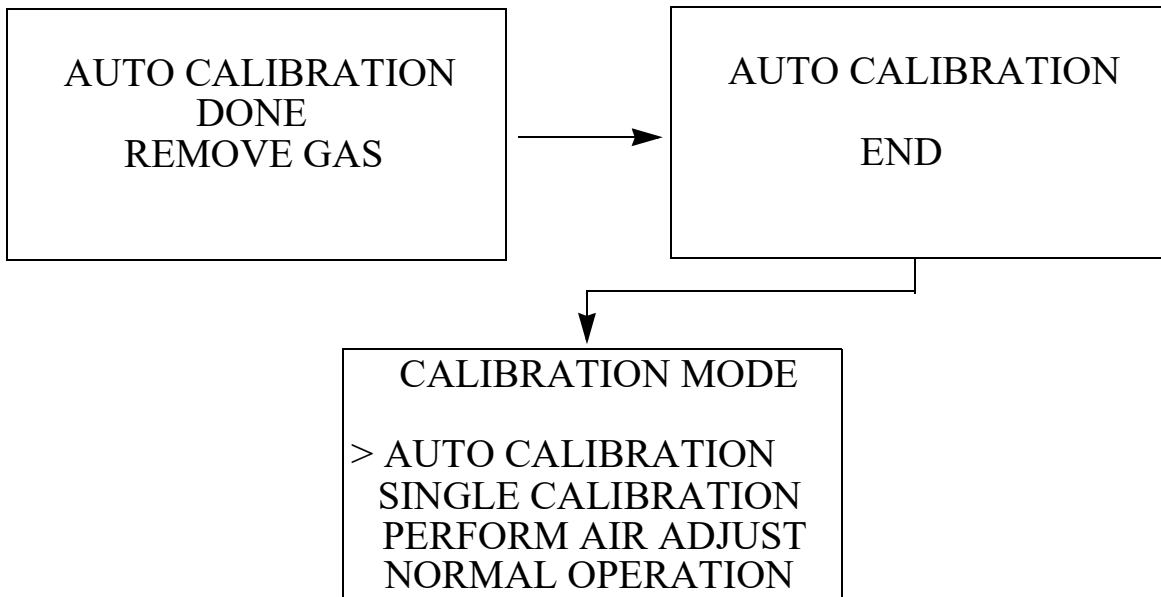

If the ESM-01 channel cannot be adjusted to the proper value, a screen displays that indicates a calibration failure and indicates that the ESM-01 sensor failed to calibrate.

FAILED SENSOR  
  
ENTER TO CONTINUE  
  
<SO2>

The buzzer and alarm LEDs activate in a double pulsing pattern. Press and release the POWER ENTER RESET button to reset the alarm and continue to the Calibration Mode Screen. Attempt to calibrate the ESM-01 channel again. If the failure continues, investigate the cause. See “Troubleshooting” on page 67.

34. Disconnect the tubing from the probe.
35. Unscrew the demand flow regulator from the calibration cylinder.
36. Use the RANGE ▼ SHIFT button to place the cursor next to the **NORMAL OPERATION** menu option, then press and release the POWER ENTER RESET button to return to Measuring Mode.

---

## Maintenance

The SO<sub>2</sub> and HCN ESM-01 sensors are the only ESM-01 sensors that include user serviceable parts. This section includes a procedure for replacing an ESM-01 sensor and for replacing the H<sub>2</sub>S scrubber in the SO<sub>2</sub> and HCN sensors. When replacing a sensor, you may either replace it with another of the same sensor or you may install a different ESM-01 sensor. If a different one is installed, the EAGLE 2 will load the sensor parameters and configure the ESM-01 channel for the new sensor.

### Replacing the ESM-01 Sensor or Changing Sensor Type

1. Verify that the EAGLE 2 is off.
2. Place the EAGLE 2 upside down on a flat surface or hold it upside down.
3. Unscrew the three case screws until they disengage from the top case. They are captive screws so they will not fall off of the bottom case.
4. Turn the EAGLE 2 right side up and carefully lift the top case away from the bottom case. Be careful not to lift it so far that it pulls on the main PCB with the cable that connects the top case to the main PCB.
5. Lay the top case down next to the bottom case to allow access to the flow system.
6. Locate the ESM-01 sensor. It has a twelve wire cable with a connector that mates to an ESM-01 sub PCB that is installed on the main PCB and is normally located next to the pump. Figure 37 on page 165 shows an ESM-01 sensor in a typical location.
7. Unscrew and remove the two screws that hold down the ESM-01 sensor bracket.
8. Grasp the sensor firmly and pull it out of the ESM-01 flow chamber. Rock it back and forth gently if necessary to pull it out. Take care not to pull the cable from the sub PCB.
9. Rotate the locking lever counterclockwise on the cable connector that mates to the ESM-01 sensor to unlock it.
10. Unplug the old ESM-01 sensor from the cable.
11. Connect the new ESM-01 sensor to the sensor cable and rotate the locking lever clockwise to lock the connector.
12. Insert the sensor into the ESM-01 flow chamber and push it in until it bottoms out.
13. Line up the holes in the ESM-01 sensor bracket with the two standoffs on the ESM-01 chamber.
14. Install the two sensor bracket screws.

15. Confirm that the main PCB is seated in its slots and that its bottom edge is resting on the bottom of the bottom case. If the main PCB is not seated properly, it may be damaged when the top case is re-installed.
16. Make sure that the top case gasket is fully seated in its groove and carefully put the top case back on the bottom case. If you have any difficulty mating the top and bottom cases, inspect the placement of the main PCB and the placement of the top case gasket.
17. Turn the EAGLE 2 upside down and tighten the three case screws to secure the top case to the bottom case.
18. Calibrate the ESM-01 channel as described in “ESM-01 Calibration” on page 166.

## **Replacing the H<sub>2</sub>S Scrubber in the SO<sub>2</sub> and HCN Sensors**

1. Verify that the EAGLE 2 is off.
2. Place the EAGLE 2 upside down on a flat surface or hold it upside down.
3. Unscrew the three case screws until they disengage from the top case. They are captive screws so they will not fall off of the bottom case.
4. Turn the EAGLE 2 right side up and carefully lift the top case away from the bottom case. Be careful not to lift it so far that it pulls on the main PCB with the cable that connects the top case to the main PCB.
5. Lay the top case down next to the bottom case to allow access to the flow system.
6. Locate the ESM-01 sensor. It has a twelve wire cable with a connector that mates to an ESM-01 sub PCB that is installed on the main PCB and is normally located next to the pump. Figure 37 on page 165 shows an ESM-01 sensor in a typical location.
7. Unscrew and remove the two screws that hold down the ESM-01 sensor bracket.
8. Grasp the sensor firmly and pull it out of the ESM-01 flow chamber. Rock it back and forth gently if necessary to pull it out. Take care not to pull the cable from the sub PCB.
9. Rotate the locking lever counterclockwise on the cable connector that mates to the ESM-01 sensor to unlock it.
10. Unplug the ESM-01 sensor from the cable.

11. The ESM-01 sensor consists of an electrolyte reservoir assembly retained in the sensor body by a threaded collar on the connector end of the sensor. Unscrew the collar from the sensor body.

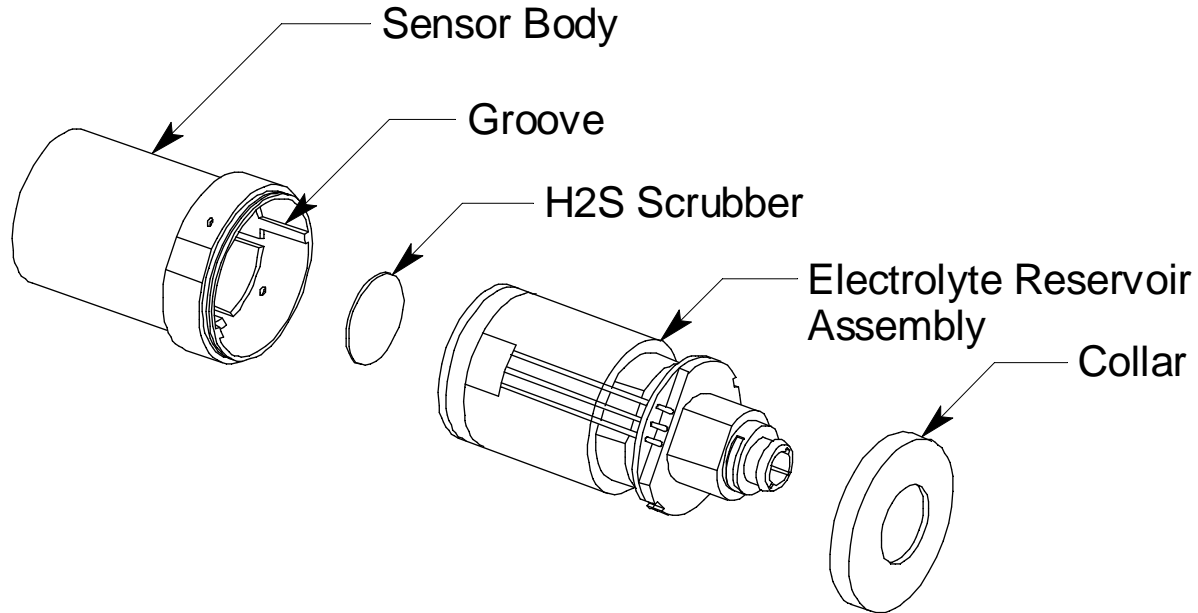

**Figure 38: ESM-01 Sensor Component Location**

12. Grasp the connector and lift the electrolyte reservoir assembly out of the sensor body.
13. Turn the body upside down to remove the H<sub>2</sub>S scrubber. If it does not come out, push on it from the top of the upside down body.
14. Discard the old H<sub>2</sub>S scrubber.
15. Carefully place the new H<sub>2</sub>S scrubber in the end of the sensor body. If the O-ring came out, place it back in making sure it is seated in its groove.
16. Place the electrolyte reservoir assembly back in the sensor body making sure that the ridges on the electrolyte reservoir assembly line up with the grooves inside the sensor body.

**CAUTION:** *Verify that the electrolyte reservoir assembly is properly aligned before inserting it into the sensor body. Forcing an electrolyte reservoir assembly into its sensor body may damage the electrolyte reservoir assembly or the sensor body.*

17. Screw the collar of the ESM-01 sensor back on.
18. Plug the ESM-01 sensor back into the cable.
19. Insert the sensor into the ESM-01 flow chamber and push it in until it bottoms out.
20. Line up the holes in the ESM-01 sensor bracket with the two standoffs on the ESM-01 chamber.
21. Install the two sensor bracket screws.
22. Confirm that the main PCB is seated in its slots and that its bottom edge is resting on the bottom of the bottom case. If the main PCB is not seated properly, it may be damaged when the top case is re-installed.

23. Make sure that the top case gasket is fully seated in its groove and carefully put the top case back on the bottom case. If you have any difficulty mating the top and bottom cases, inspect the placement of the main PCB and the placement of the top case gasket.
24. Turn the EAGLE 2 upside down and tighten the three case screws to secure the top case to the bottom case.
25. Calibrate the ESM-01 channel as described in “ESM-01 Calibration” on page 166.

## Parts List

**Table 20: ESM-01 EAGLE 2 Parts List**

Part Number	Description
33-7120RK	H <sub>2</sub> S scrubber disk, for ESM-01DH-D-HCN sensor
33-7121RK	H <sub>2</sub> S scrubber disk, for ESM-01DH-F-SO <sub>2</sub> sensor
47-5015RK	ESM-01 sensor cable
ESM-01DH-ASH3	Arsine sensor, 0-1.50 ppm
ESM-01R-NH <sub>3</sub>	Ammonia sensor, 0-75.0 ppm
ESM-01DH-D-HCN	Hydrogen cyanide sensor, 0-15.0 ppm
ESM-01DH-PH <sub>3</sub>	Phosphine sensor, 0-1.00 ppm
ESM-01DH-F-SO <sub>2</sub>	Sulfur dioxide sensor, 0-6.00 ppm
ESM-K01-CL <sub>2</sub>	Chlorine sensor, 0-3.00 ppm
81-0142RK-02	Calibration cylinder, 5-gas (SO <sub>2</sub> , CH <sub>4</sub> , O <sub>2</sub> , H <sub>2</sub> S, CO), 58-liter aluminum
81-0142RK-04	Calibration cylinder, 5-gas (SO <sub>2</sub> , CH <sub>4</sub> , O <sub>2</sub> , H <sub>2</sub> S, CO), 34-liter aluminum
81-0170RK-02	Calibration cylinder, 5 ppm SO <sub>2</sub> in nitrogen, 58 liter
81-0170RK-04	Calibration cylinder, 5 ppm SO <sub>2</sub> in nitrogen, 34 liter
81-0175RK-02	Calibration cylinder, 10 ppm NH <sub>3</sub> in nitrogen, 58 liter
81-0175RK-04	Calibration cylinder, 10 ppm NH <sub>3</sub> in nitrogen, 34 liter
81-0185RK-02	Calibration cylinder, 0.5 ppm PH <sub>3</sub> in nitrogen, 58 liter
81-0192RK-02	Calibration cylinder, 2 ppm Cl <sub>2</sub> in nitrogen, 58 liter
81-0192RK-04	Calibration cylinder, 2 ppm Cl <sub>2</sub> in nitrogen, 34 liter
81-0196RK-02	Calibration cylinder, 10 ppm HCN in nitrogen, 58 liter
81-0196RK-04	Calibration cylinder, 10 ppm HCN in nitrogen, 34 liter

# Appendix F: TC Sensors

---

## Overview

The TC sensors are used to monitor high levels of combustible gas. This appendix describes the EAGLE 2's TC sensor and includes instructions to use an EAGLE 2 that has a TC sensor installed. It also includes instructions to calibrate and replace a TC sensor.

**Table 21: TC Sensor Specifications**

Target Gas	Detection Range	Reading Increment	Alarm 1 Factory Setting	Alarm 2 Factory Setting	STEL	TWA
Methane (CH <sub>4</sub> )	0 - 100.0 %vol	0.5 %vol	OFF	OFF	OFF	OFF
Hydrogen (H <sub>2</sub> )	0 - 100.0 %vol	0.5 %vol	10.0 %vol	50.0 %vol	OFF	OFF
Hydrogen (H <sub>2</sub> )	0 - 10.0 %vol	0.1 %vol	1.0 %vol	5.0 %vol	OFF	OFF

---

## Description

The TC sensor is installed in a single sensor flow chamber which is located in the area next to the standard 4-sensor flow chamber. This area can accommodate up to three single sensor flow chambers. Figure 39 below illustrates a typical TC sensor location in front of the pump. The TC flow chamber may also be installed in one of the other two sensor chamber locations depending on the particular version of the EAGLE 2. Some TC sensor instrument configurations do not include the 4-sensor flow chamber.

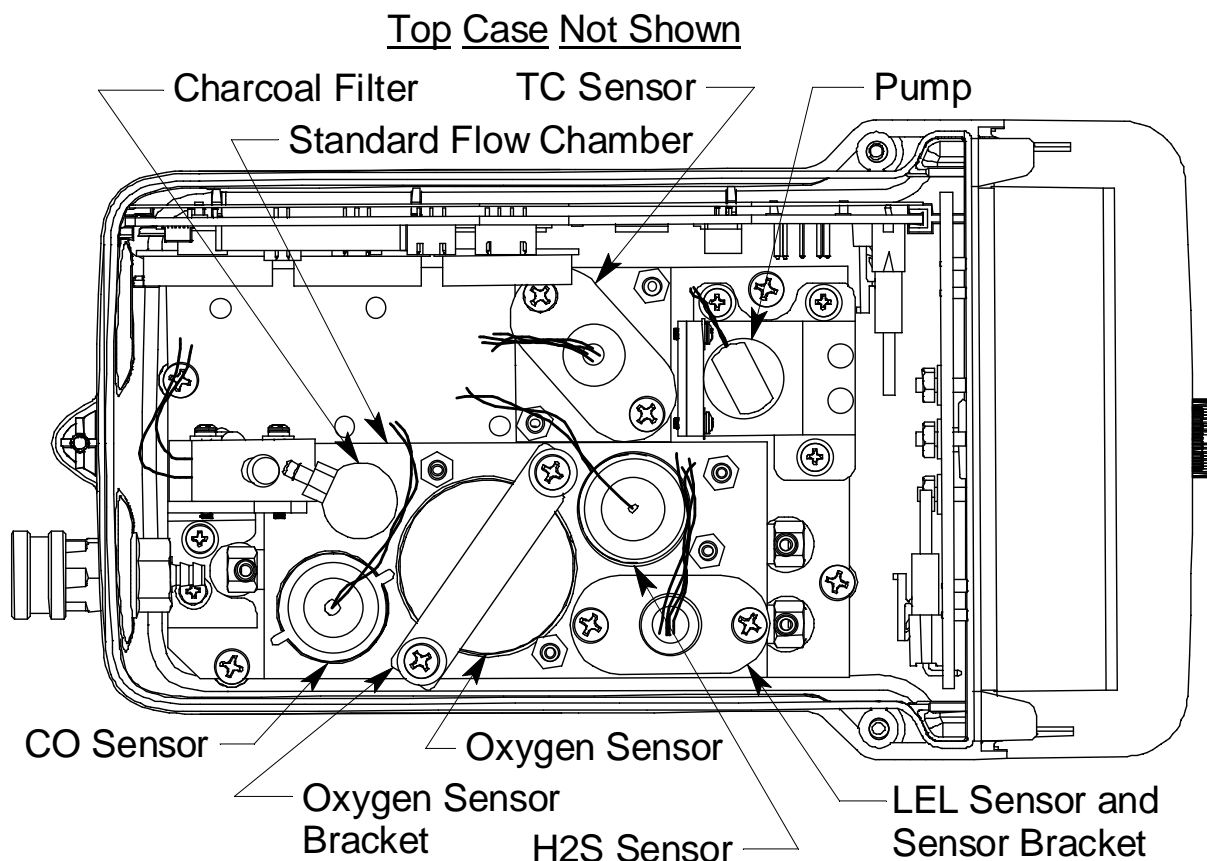

**Figure 39: Typical TC Sensor Location**

### TC Sensor

The TC sensor's appearance is exactly the same as that of the LEL sensor. Its housing includes a sintered metal flame arrestor on one end that allows gas to diffuse into the sensor. On the other end, five pins extend from the sensor. The TC sensor can be distinguished from the LEL sensor by the part number imprinted on it. The TC sensor part number is TE-7568 while the LEL part number is NC-6260B. The sensor cable connects to pins on one end and terminates in a four-position connector on the other end which plugs into the TC sub PCB (see description below). The sensor bracket is installed over the TC sensor to keep it seated in place.

**NOTE:** The LEL and TC sensors and sensor cables are identical in appearance. Take care not to plug the LEL sensor cable into the port on the TC sub PCB and not to plug the TC sensor cable into the LEL port on the main PCB.

### TC Sub PCB

The TC sub PCB is a circuit board that is installed on the main PCB in one of the 3 sub PCB positions when a TC sensor is used with the EAGLE 2. The TC sensor cable connects to the sub PCB. The sub PCB plugs into the main PCB and is held in place with a screw/flat washer/lock washer. There are no user serviceable parts on the TC sub PCB.

---

## Start Up and Normal Operation

For instructions to startup and use an EAGLE 2 that includes a TC sensor, reference “Start Up” on page 27, “Measuring Mode, Normal Operation” on page 33, and “Measuring Mode, Alarms” on page 38. Follow these instructions keeping the following in mind:

- The TC sensor is used to monitor combustible gases above their LEL (lower explosive limit). When monitoring the target gas in %volume, be aware that you may be monitoring gas levels that are potentially explosive.

---

## Catalytic (LEL) Sensor Screen

When either a TC sensor or an infrared combustible sensor is installed in an EAGLE 2 along with a catalytic combustible LEL sensor, the user has the option of turning off the catalytic combustible LEL sensor in Display Mode. If the unit is going to be used for sampling known high-levels of combustible gas or in areas with known catalytic sensor poisons such as silicone vapors, the catalytic combustible sensor should be turned off. Even though this sensor has its own protective shut off, exposure to high levels of combustible gas can still stress the catalytic LEL sensor. The catalytic LEL sensor can be enabled or disabled in the Catalytic (LEL) Sensor screen in Display Mode. The default setting is enabled. To change the setting, do the following:

**NOTE:** The Catalytic (LEL) Sensor setting is reset when the EAGLE 2 is turned off. When the EAGLE 2 is turned on, this setting is always ENABLED.

1. Use the DISPLAY ADJUST NO button to enter Display Mode and scroll to the Catalytic (LEL) Sensor screen. The current setting will be flashing. The screen below indicates the warning that appears when a TC sensor and a catalytic LEL sensor are both installed. Since the TC sensor only reads in %volume, if the catalytic LEL sensor is disabled, there will be no alarms for the LEL range.

CAT (LEL) SENSOR  
\* \* \* WARNING \* \* \*  
NO LEL ALARMS IF  
CAT (LEL) IS DISABLED  
  
ENABLED

2. Use the AIR ▲ YES or RANGE ▼ SHIFT button to toggle to the desired setting. If set to DISABLED, the gas reading for the catalytic LEL channel will be replaced by dashes (---).
3. Press and release POWER ENTER RESET to save the setting and return to the main menu.
4. Use the DISPLAY ADJUST NO button to scroll through the rest of Display Mode and enter Normal Operation.

---

## TC Calibration

A TC channel can be calibrated using the auto calibration method or the single calibration method. To calibrate a TC channel using the single calibration method, see “Calibrating Using the Single Calibration Method” on page 62 and follow the instructions for calibrating a single channel. If your instrument is a multi-channel instrument that includes one or more TC channels, RKI Instruments, Inc. recommends using the auto calibration method for convenience. The calibration instructions below show a 5 channel instrument which has the four standard channels, LEL/oxygen/H<sub>2</sub>S/CO, and a TC channel configured for 0-100 %vol CH<sub>4</sub>. To use the auto calibration method to calibrate a multi-channel instrument that includes a TC channel, do the following:

1. See “Calibration Supplies and Equipment” on page 55 for a description of the necessary calibration supplies. In addition to an appropriate multi-gas cylinder that is used to calibrate any active standard channels, you will also need a cylinder to calibrate the TC channel. See Table 22 on page 199 for available cylinders. Make sure your calibration cylinder is appropriate for the TC detection range.

If the EAGLE 2 is intended for use in a landfill, RKI Instruments, Inc. recommends using the carbon dioxide/methane mix calibration cylinder because it is representative of gases present in a landfill.

**NOTE:** If your instrument has more than one TC sensor, you will need a calibration cylinder for each sensor.

2. Find a fresh-air environment. This is an environment free of toxic or combustible gases and of normal oxygen content (20.9%).
3. While in Measuring Mode, press and hold the RANGE ▼ SHIFT button, then press the DISPLAY ADJUST NO button and release both buttons.
4. If the unit prompts you for the password, enter it by using the AIR ▲ YES and RANGE ▼ SHIFT buttons to select each password number and then pressing and releasing POWER ENTER RESET to enter the number and move on to the next one.
5. The Calibration Mode Screen displays with the cursor next to **AUTO CALIBRATION**.

<p style="text-align: center;">CALIBRATION MODE</p> <p>&gt; AUTO CALIBRATION SINGLE CALIBRATION PERFORM AIR ADJUST NORMAL OPERATION</p>
---

6. Move the cursor to the **PERFORM AIR ADJUST** menu item by using the RANGE ▼ SHIFT button.

CALIBRATION MODE  
AUTO CALIBRATION  
SINGLE CALIBRATION  
> PERFORM AIR ADJUST  
NORMAL OPERATION

7. Press and release the POWER ENTER RESET button. The following screen appears.

PERFORM  
AIR ADJUST?

8. Press and release the AIR ▲ YES button to continue.  
If you do not want to continue, press the DISPLAY ADJUST NO button and the unit will return to the Calibration Mode Screen.
9. The EAGLE 2 will indicate that it is adjusting the zero reading for a few seconds, then indicate that the operation is complete before returning to the Calibration Mode Screen.

ADJUSTING ZERO  
RELEASE AIR BUTTON



ADJUSTING ZERO  
COMPLETE



CALIBRATION MODE  
AUTO CALIBRATION  
SINGLE CALIBRATION  
> PERFORM AIR ADJUST  
NORMAL OPERATION

10. Install the demand flow regulator onto the multi-gas calibration cylinder.
11. Connect the sample tubing to the demand flow regulator.
12. Install the probe on the EAGLE 2 inlet fitting. Make sure the probe is complete with internal O-ring and membrane and that the two halves of the probe are tightened firmly together to avoid leaks that can affect the calibration. See Figure 21, “Replacing the Particle Filter and Hydrophobic Filter Disk” on page 72 for an illustration of the internal parts of the probe.
13. Move the cursor next to the **AUTO CALIBRATION** menu item by using the AIR ▲ YES button.

```

CALIBRATION MODE
> AUTO CALIBRATION
  SINGLE CALIBRATION
  PERFORM AIR ADJUST
  NORMAL OPERATION
  
```

14. Press and release the POWER ENTER RESET button to display the Calibration Gas Values Screen.

```

CAL GAS VALUES
CH4   50 %LEL
OXY  12.0 vol%
H2S  25.0 ppm
CO    50 ppm
ENTER TO BEGIN CAL
  
```

The gas concentrations displayed in the Calibration Gas Values Screen must match the gas concentrations listed on the 4-gas calibration cylinder.

If *all* concentrations match, go to Step 25.

If *one or more* concentrations *do not* match, continue with Step 15.

If you do not want to continue with the calibration, press and release the DISPLAY ADJUST NO button to return to the Calibration Mode Screen.

**NOTE:** The RKI 4-gas cylinder typically contains 12% O<sub>2</sub> by volume. When using the auto calibration method, be sure to set the “OXY” auto calibration value to agree with the concentration listed on the cylinder’s label, not zero.

15. To adjust the values on the screen, press and hold the RANGE ▼ SHIFT button, then press the DISPLAY ADJUST NO button and release both. The following screen appears with the cursor next to **CH4**.

```

ADJUST AUTO
CALIBRATION VALUES
> CH4   50 %LEL
  OXY  12.0 vol%
  H2S  25.0 ppm
  CO    50 ppm ▼
  
```

16. Place the cursor next to the channel whose gas value you want to change using the AIR ▲ YES and RANGE ▼ SHIFT buttons.
17. Press and release the POWER ENTER RESET button to select the channel. The calibration gas value begins to flash.
18. Use the AIR ▲ YES and RANGE ▼ SHIFT buttons to adjust the calibration gas setting to the desired value.

**NOTE:** The calibration gas setting value be set lower than the low alarm setting. If the calibration gas value listed on the calibration cylinder is lower than the current low alarm setting, enter Setup Mode and change the low alarm setting. See “Updating the Alarm Point Settings” on page 106 for instructions. If you need to change the alarm point setting only to perform a calibration, make sure that you change the alarm point setting back to its original value once the calibration has been performed.

19. Press and release the POWER ENTER RESET button to save the change. The calibration gas value stops flashing.
20. Repeat Step 16 through Step 19 for any other channels that need to be changed.
21. When you are done adjusting the calibration gas values, move the cursor down past the bottom of the screen next to **END**.

ADJUST AUTO  
CALIBRATION VALUES  
> END ▲

22. Press and release the POWER ENTER RESET button. The following screen appears.

DO YOU WANT TO  
STORE NEW VALUE(S)  
IN MEMORY FOR  
FUTURE CALIBRATIONS?  
  
PRESS YES OR NO

23. If you select YES by pressing and releasing the AIR ▲ YES button, the changes that you made will be saved in the EAGLE 2’s memory as the new auto calibration gas values.

If you select NO by pressing and releasing the DISPLAY ADJUST NO button, the changes you made will be used for any calibrations performed during the current operating session only. The EAGLE 2 will delete the changes when the unit is turned off and will load the previous set of auto calibration values when it is turned on again.

24. When you make your selection and press the desired button, the unit returns to the Calibration Gas Values Screen.

```

CAL GAS VALUES
CH4  50 %LEL
OXY  12.0 vol%
H2S  25.0 ppm
CO   50 ppm
ENTER TO BEGIN CAL
  
```

25. Press and release the POWER ENTER RESET button to proceed to the Calibration In Process Screen with **CAL IN PROCESS** flashing.

```

CAL IN PROCESS
CH4   0 %LEL
OXY  20.9 vol%
H2S   0.0 ppm
CO    0 ppm
ENTER WHEN DONE
  
```

If you do not want to proceed with the calibration, press and release the DISPLAY ADJUST NO button to return to the Cal Gas Values Screen.

If you do want to continue with the calibration, proceed to the next step.

26. Connect the tubing from the demand flow regulator to the rigid tube on the probe. Allow the EAGLE 2 to draw gas for one minute.
27. Press and release the POWER ENTER RESET button to set the span adjustment for each channel to the programmed values.
28. If all channels passed calibration, the following screen sequence occurs.

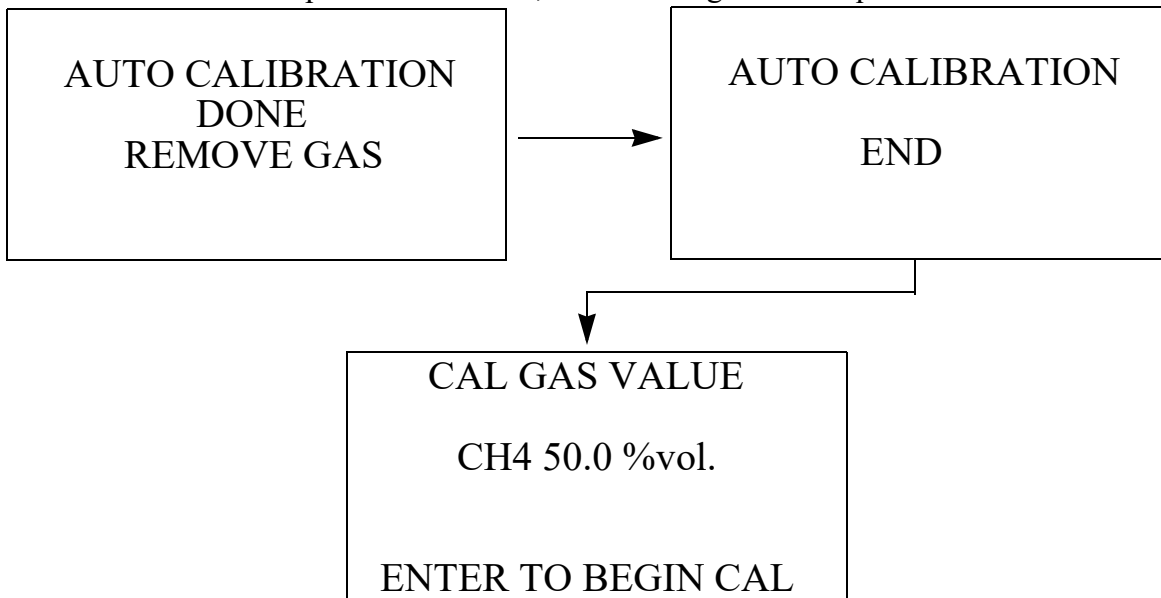

If any of the sensors cannot be adjusted to the proper value, a screen displays that indicates a calibration failure and lists the sensor(s) that failed to calibrate. In the example below, the oxygen and H<sub>2</sub>S channels failed calibration. The other sensors calibrated normally.

FAIL SENSOR  
  
< > <OXY>  
<H2S> < >  
  
ENTER TO CONTINUE

The buzzer and alarm LEDs activate in a double pulsing pattern. Press and release the POWER ENTER RESET button to reset the alarm and continue to the Calibration Value Screen for the TC channel. After calibrating the TC channel by following the instructions below, attempt to calibrate the standard channels again. If the failure continues, investigate the cause. See “Troubleshooting” on page 67.

29. Remove the tubing from the rigid tube on the probe.
30. Unscrew the 4-gas cylinder from the demand flow regulator.
31. If you want to change the TC channel’s calibration gas value, follow Step 15 - Step 24 above beginning with the TC Calibration Gas Value Screen below instead of the standard channel Calibration Gas Value Screen.

CAL GAS VALUE  
  
CH4 50.0 %vol.  
  
ENTER TO BEGIN CAL

32. With the TC Calibration Gas Value Screen displayed, press and release the POWER ENTER RESET button to proceed to the Calibration In Process Screen for the TC channel with **CAL IN PROCESS** flashing.

CAL IN PROCESS  
  
CH4 0.0 %vol.  
  
ENTER WHEN DONE

If you do not want to proceed with the calibration, press and release the DISPLAY ADJUST NO button to return to the TC Cal Gas Values Screen.

If you do want to continue with the calibration, proceed to the next step.

33. Screw the new TC calibration cylinder onto the demand flow regulator.
34. Connect the tubing from the regulator to the rigid tube on the probe. Allow the EAGLE 2 to draw gas for one minute.
35. Press and release the POWER ENTER RESET button to set the span adjustment for the TC channel to the programmed value.

36. If the TC channel passed calibration, the following screen sequence occurs.

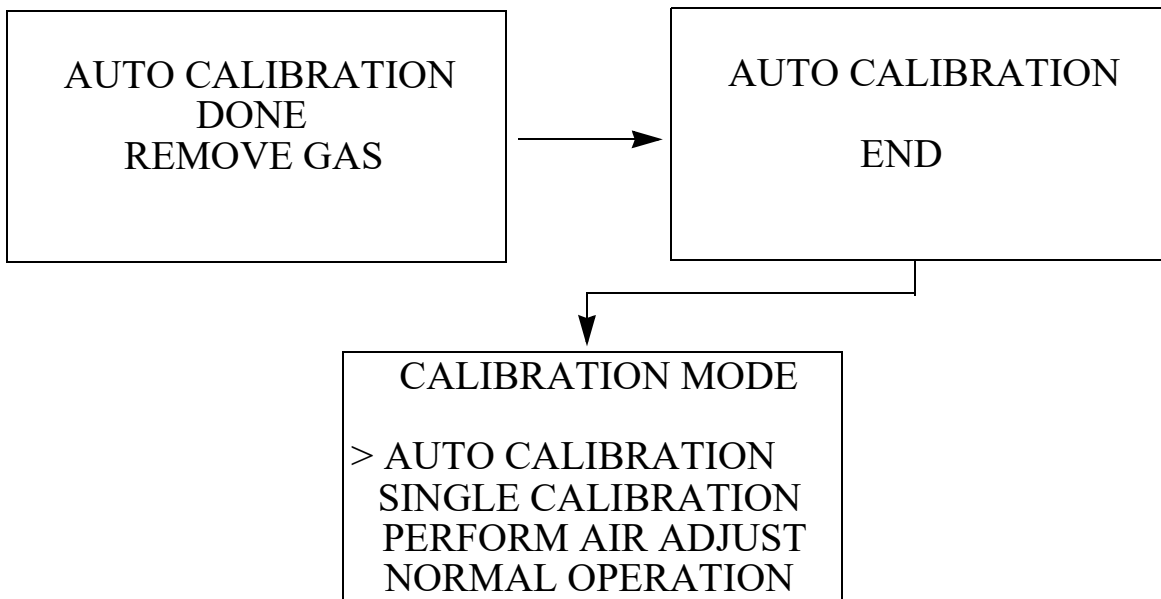

If the TC channel cannot be adjusted to the proper value, a screen displays that indicates a calibration failure and indicates that the TC sensor failed to calibrate.

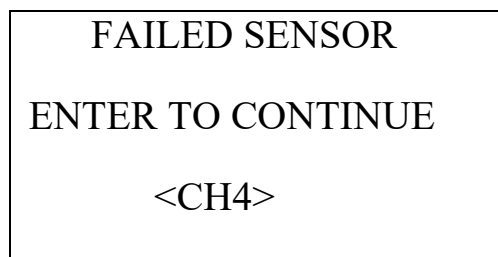

The buzzer and alarm LEDs activate in a double pulsing pattern. Press and release the POWER ENTER RESET button to reset the alarm and continue to the Calibration Mode Screen. Attempt to calibrate the TC channel again. If the failure continues, investigate the cause. See “Troubleshooting” on page 67.

37. Disconnect the tubing from the probe.
38. Unscrew the demand flow regulator from the calibration cylinder.
39. Use the RANGE ▼ SHIFT button to place the cursor next to the **NORMAL OPERATION** menu option, then press and release the POWER ENTER RESET button to return to Measuring Mode.

---

## Maintenance

The TC sensor does not include any user serviceable parts. This section includes a procedure for replacing the TC sensor.

### Replacing the TC Sensor

1. Verify that the EAGLE 2 is off.
2. Place the EAGLE 2 upside down on a flat surface or hold it upside down.

3. Unscrew the three case screws until they disengage from the top case. They are captive screws so they will not fall off of the bottom case.
4. Turn the EAGLE 2 right side up and carefully lift the top case away from the bottom case. Be careful not to lift it so far that it pulls on the main PCB with the cable that connects the top case to the main PCB.
5. Lay the top case down next to the bottom case to allow access to the flow system.
6. Locate the TC sensor. It has a five wire cable with a connector that mates to a TC sub PCB that is installed on the main PCB and is normally located in a single sensor flow chamber next to the pump. Figure 39 on page 185 shows a TC sensor in a typical location.
7. Unscrew and remove the two screws that hold down the TC sensor bracket.
8. Grasp the TC sensor connector and gently pull it up until it either disengages from the TC sensor or the TC sensor comes out of the flow chamber with the connector.
9. If the sensor came out with the connector, remove the sensor from the connector.
10. If the sensor stayed in the flow chamber, grasp the sensor and pull it out of the flow chamber.
11. Plug the replacement sensor into the sensor connector on the TC sensor cable.
12. Insert the TC sensor into the TC sensor chamber in the flow chamber.
13. Line up the holes in the TC sensor retaining bracket with the two standoffs on either side of the TC sensor chamber.
14. Install the two sensor retaining screws tightening them a little at a time alternately to push the sensor into its chamber evenly.
15. Confirm that the main PCB is seated in its slots and that its bottom edge is resting on the bottom of the bottom case. If the main PCB is not seated properly, it may be damaged when the top case is reinstalled.
16. Make sure that the top case gasket is fully seated in its groove and carefully put the top case back on the bottom case. If you have any difficulty mating the top and bottom cases, inspect the placement of the main PCB and the placement of the top case gasket.
17. Turn the EAGLE 2 upside down and tighten the three case screws to secure the top case to the bottom case.
18. Calibrate the TC channel as described in “TC Calibration” on page 187.

## Configuring the TC Gas in Setup Mode

The TC channel can be configured for 3 different pre-defined gases and 1 user-defined gas in the CONFIGURE GASES menu item in Setup Mode. To change the gas configuration of the TC channel in Setup Mode, do the following:

**WARNING:** *Do not use the user defined gas configuration without consulting RKI Instruments, Inc.*

**WARNING:** *The EAGLE 2 is not in operation as a gas detector while in Setup Mode.*

1. Take the EAGLE 2 to a non-hazardous location and turn it off if it is on.
2. Press and hold AIR ▲ YES and RANGE ▼ SHIFT, then press and hold POWER ENTER RESET. When you hear a beep, release the buttons.
3. The LCD will show the following screen for a few seconds with the “S” in the lower right corner indicating the unit is entering Setup Mode.



4. The “S” will then disappear and the following screen will appear for a few seconds.



5. If the unit prompts you for the password, enter it by using AIR ▲ YES and RANGE ▼ SHIFT to select each password number and then pressing and releasing the POWER ENTER RESET button to enter it and move on to the next number until all of the numbers are entered. The main menu displays. It displays six menu items at a time.

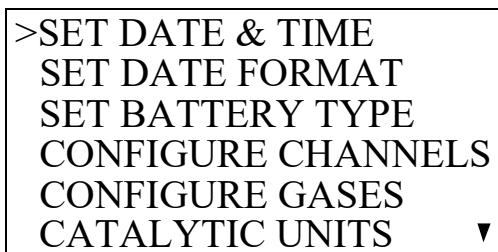

6. Use the RANGE ▼ SHIFT button to move the cursor down the menu to CONFIGURE GASES.

- Press and release POWER ENTER RESET. The Configure Gases Screen appears with the cursor flashing next to CAT, the catalytic sensor. If an EAGLE 2 has a TC sensor installed, one of the three optional sensor types, OP1, OP2, or OP3 will indicate it is a TC. In the example below, OP1 is shown as a TC sensor.

```

CONFIGURE GASES
> CAT : CH4 (CAT)
  OP1 : CH4 (TC)
  OP2 : --- (---)
  OP3 : --- (---)

```

- Use RANGE ▼ SHIFT to move the cursor down the menu to the TC sensor.

```

CONFIGURE GASES
CAT : CH4 (CAT)
> OP1 : CH4 (TC)
  OP2 : --- (---)
  OP3 : --- (---)

```

- To change the TC sensor gas configuration, press and release POWER ENTER RESET.
- A screen appears that indicates the detection range for the currently configured gas. In the example below, the TC sensor is currently configured for 0 - 100 %volume CH<sub>4</sub>. The screen also shows the gas configuration choices for the TC sensor. There are 3 pre-defined options and 1 user-defined option. The user-defined option will always have an asterisk next to it.

```

TC (0-100.0vol%CH4)
> 100.0 vol% CH4
  100.0 vol% H2
   10.0 vol% H2
   10.0 vol% TC

```

- Use AIR ▲ YES and RANGE ▼ SHIFT to move the cursor next to the desired gas.
- If you placed the cursor next to one of the pre-defined gases, press and release POWER ENTER RESET to select the gas and proceed to Step 17.

If you placed the cursor next to the user defined gas with the asterisk (\*), press POWER ENTER RESET and proceed with Step 13.

13. The user defined gas setup screen appears with the first character of the gas name flashing. The current gas name and range are shown on the top line of the screen.

```
TC (0-100.0vol%CH4)
CHANGE TO NAME
TC
FULL_SCALE      10.0
```

**WARNING:** *Do not use the user defined gas configuration without consulting RKI Instruments, Inc.*

14. Enter the gas name. There are 3 characters available for the gas name. The factory setting of TC uses only 2 characters. Use AIR ▲ YES and RANGE ▼ SHIFT to display the desired character, then press POWER ENTER RESET to enter the displayed character and move to the next character. Repeat until all three characters are entered. When the last character is entered, the full scale value will be flashing.
15. Use AIR ▲ YES and RANGE ▼ SHIFT to display the desired full scale value. It may be any value from 10 to 100 in increments of 10.
16. Press and release POWER ENTER RESET to enter the full scale value. The confirmation screen appears. In the example below, the user defined gas has been selected and defined as propane with the gas name set to PRO.

```
CHANGE TO PRO ?

PRESS YES OR NO
```

17. If you want to accept the gas configuration change, press and release AIR ▲ YES. The unit will return to the Configure Gases screen.

```
CONFIGURE GASES

> CAT : CH4 (CAT)
  OP1 : PRO (TC)
  OP2 : --- (---)
  OP3 : --- (---) ▼
```

If you do not want to accept the gas configuration change, press and release DISPLAY ADJUST NO to return to the screen with the gas choices shown in Step 10 on page 196. You can either scroll down to END and press POWER ENTER RESET to return to the Configure Gases screen or continue from Step 10 on page 196 to select a new gas.

18. Use RANGE ▼ SHIFT to place the cursor next to **END**.
19. Press and release POWER ENTER RESET to return to the main menu.

20. Use RANGE ▼ SHIFT to place the cursor in front of **NORMAL OPERATION** at the bottom of the main menu.
21. Press and release POWER ENTER RESET.
22. A screen appears that asks if you want to save the changes you have made.

**SAVE ALL CHANGES  
IN MEMORY?**

**NOTE:** If you entered Setup Mode and did not make any changes, the above screen will still appear. In this case, press and release DISPLAY ADJUST NO to proceed to exit Setup Mode and begin the EAGLE 2's startup sequence.

23. If you do not want to save the changes, press and release DISPLAY ADJUST NO. The unit will begin its startup sequence without saving the changes.

If you do want to save the changes, press and release AIR ▲ YES and continue with the next step.

24. A confirmation screen appears asking if you are sure you want to save the changes.

**ARE YOU SURE YOU  
WANT TO SAVE ALL  
CHANGES IN MEMORY?**

25. If you want to save the changes, press and release AIR ▲ YES to save the changes. A screen will appear for a few seconds indicating that the changes have been saved and the unit will begin its startup sequence.

If you do not want to save the changes, press and release DISPLAY ADJUST NO to proceed to the unit's startup sequence without saving changes.

## Parts List

Table 22: TC EAGLE 2 Parts List

Part Number	Description
47-5010RK	TC/LEL sensor cable
TE-7568	TC sensor
81-0013RK-01	Calibration cylinder, 50% vol CH <sub>4</sub> in N <sub>2</sub> , 34 liter steel
81-0013RK-05	Calibration cylinder, 50% vol CH <sub>4</sub> in N <sub>2</sub> , 58 liter steel
81-0023RK-01	Calibration cylinder, H <sub>2</sub> , 8% volume in nitrogen, 34 liter steel
81-0024RK-01	Calibration cylinder, H <sub>2</sub> , 100% volume, 34 liter steel
81-0025RK-01	Calibration cylinder, 35% CO <sub>2</sub> /50% CH <sub>4</sub> , balance N <sub>2</sub> , 34 liter steel, intended for landfill applications

# Appendix G: Infrared Carbon Dioxide Sensors

---

## Overview

The infrared CO<sub>2</sub> sensors are used to monitor levels of carbon dioxide. This appendix describes the EAGLE 2's infrared CO<sub>2</sub> sensors and includes instructions to use an EAGLE 2 that has one or more infrared CO<sub>2</sub> sensors installed. It also includes instructions to replace an infrared CO<sub>2</sub> sensor.

**Table 23: Infrared CO<sub>2</sub> Sensor Specifications**

Range	Increment	Alarm 1 Factory Setting	Alarm 2 Factory Setting	STEL (ppm)	TWA (ppm)
0-5.00 %vol	0.02 %vol	0.5 %vol	3.0 %vol	3.0	0.5
0-10,000 ppm	25 ppm	5,000 ppm	OFF	5,000	OFF
0-60.0 %vol	0.2 %vol	OFF	OFF	OFF	OFF

---

## Description

Table 23 above lists the available infrared CO<sub>2</sub> sensors. The infrared CO<sub>2</sub> sensor is a smart sensor that stores sensor parameters including the target gas and detection range. So you can change an existing infrared CO<sub>2</sub> channel from one range to another and the EAGLE 2 will automatically load all the sensor parameters and configure the infrared CO<sub>2</sub> channel for the new sensor without the need to enter CONFIGURE CHANNELS or CONFIGURE GASES in Setup Mode. See “Replacing the IR CO<sub>2</sub> Sensor or Changing Sensor Type” on page 211 for instructions to replace or change an infrared CO<sub>2</sub> sensor.

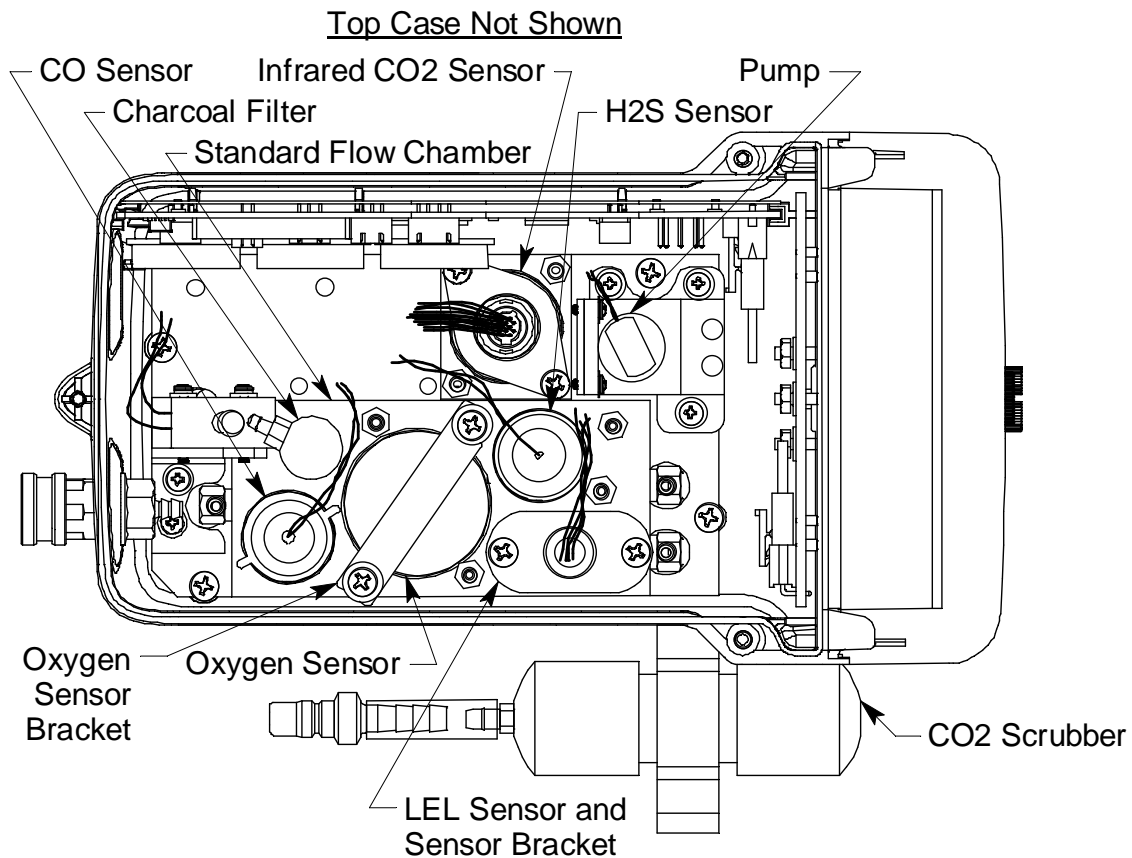

**Figure 40: Typical Infrared CO<sub>2</sub> Sensor Location**

The infrared CO<sub>2</sub> sensor is installed in a single sensor flow chamber which is located in the area next to the standard 4-sensor flow chamber. This area can accommodate up to three single sensor flow chambers. Figure 40 above illustrates a typical infrared CO<sub>2</sub> sensor location in front of the pump. The infrared CO<sub>2</sub> flow chamber may also be installed in one of the other two sensor chamber locations depending on the particular version of the EAGLE 2. Some infrared CO<sub>2</sub> instrument configurations do not include the 4-sensor flow chamber.

### **Infrared CO<sub>2</sub> Sensor**

The infrared CO<sub>2</sub> sensor is a cylindrical sensor with a diffusion opening on the front and a 12 pin circular connector on the back. A 12 wire cable plugs into the back of the infrared CO<sub>2</sub> sensor with a circular connector that includes a locking lever. The other end of the cable plugs into an infrared sub PCB (see description below) that is installed on the main PCB. The sensor is held in the infrared flow chamber by a bracket on standoffs.

### **Infrared Sub PCB**

The infrared sub PCB is a circuit board that is installed on the main PCB in one of the 3 sub PCB positions when an infrared CO<sub>2</sub> sensor is used with the EAGLE 2. The infrared CO<sub>2</sub> sensor connects to the sub PCB with a 12-position connector. The sub PCB plugs into the main PCB and is held in place with a screw/flat washer/lock washer. There are no user serviceable parts on the infrared sub PCB.

## CO<sub>2</sub> Scrubber

A carbon dioxide scrubber is mounted to the exterior side of EAGLE 2s that are factory-shipped with carbon dioxide sensors for the ranges of 0-5 %vol and 0-10,000 ppm.

**NOTE:** EAGLE 2s with a range of 0-60 %vol CO<sub>2</sub> do not include a scrubber since the normal background of CO<sub>2</sub> in air is negligible when compared to the full scale of these units.

This scrubber is for use when setting the carbon dioxide sensor's zero reading only. Two black vinyl caps cover either end of the carbon dioxide scrubber. To prolong the life of the scrubber, be sure the caps are installed while the scrubber is not in use or while it is being stored. Replace the scrubber when it turns from white to a violet color.

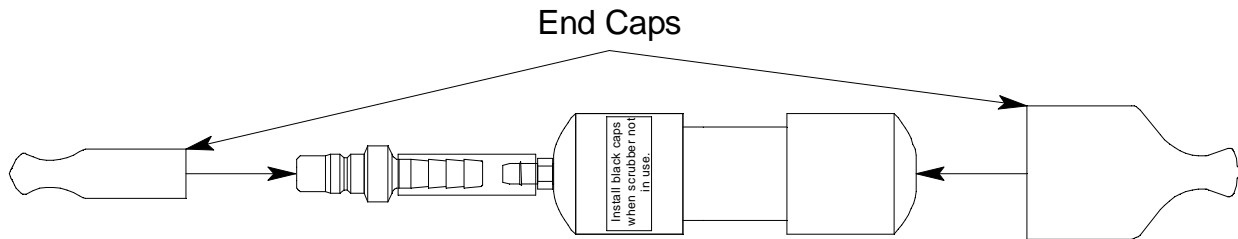

**Figure 41: Carbon Dioxide Scrubber**

---

## Start Up and Normal Operation

For instructions to startup and use an EAGLE 2 that includes an infrared CO<sub>2</sub> sensor, reference “Start Up” on page 27, “Measuring Mode, Normal Operation” on page 33, and “Measuring Mode, Alarms” on page 38. Follow these instructions keeping the following special considerations in mind:

- A background level of CO<sub>2</sub> exists in fresh air. The low range sensors will display a reading in fresh air. Table 24 below indicates typical gas readings in fresh air.

**Table 24: Carbon Dioxide Fresh Air Readings**

Sensor Range	Approximate Fresh Air Reading
0-5 %vol	0.04 %vol
0-10,000 ppm	400 ppm
0-60 %vol	0.0 %vol

- When you perform a demand zero during start up, operation, or calibration of a 0-10,000 ppm or 0-5 %vol CO<sub>2</sub> instrument, you must use the CO<sub>2</sub> scrubber provided with the instrument to remove background CO<sub>2</sub> from the air being sampled. See “Performing a Demand Zero for Carbon Dioxide Sensors” below.
- Since there is a background of CO<sub>2</sub> in air, do not use the AUTO FRESH AIR ADJ feature that can be turned on and off in Setup Mode. The factory setting for the feature is off.

## Performing a Demand Zero for Carbon Dioxide Sensors

When setting the zero reading, the carbon dioxide scrubber mounted to the side of the EAGLE 2 allows you to eliminate carbon dioxide normally found in fresh air. To perform a demand zero, do the following:

1. Remove the black caps from the ends of the carbon dioxide scrubber. Be sure to grab the scrubber by the EAGLE 2 fitting so that the fitting and tubing do not come off.
2. Connect the carbon dioxide scrubber directly to the EAGLE 2's inlet fitting.
3. Wait one minute for the fresh air sample to flow through the carbon dioxide scrubber, then press AIR ▲ YES to set the zero reading.
4. Remove the scrubber from the inlet fitting.
5. Put the caps back on the scrubber.

---

## Infrared CO<sub>2</sub> Calibration

An infrared CO<sub>2</sub> channel can be calibrated using the auto calibration method or the single calibration method. To calibrate an infrared CO<sub>2</sub> channel using the single calibration method, see “Calibrating Using the Single Calibration Method” on page 62 and follow the instructions for calibrating a single channel. If your instrument is a multi-channel instrument that includes one or more infrared CO<sub>2</sub> channels, RKI Instruments, Inc. recommends using the auto calibration method for convenience. The calibration instructions below show a 5 channel instrument which has the four standard channels, LEL/oxygen/H<sub>2</sub>S/CO, and an infrared CO<sub>2</sub> channel for 0-5 %vol. To use the auto calibration method to calibrate a multi-channel instrument that includes an infrared CO<sub>2</sub> channel, do the following:

**NOTE:** If your instrument has more than one infrared CO<sub>2</sub> sensor, you will need a calibration cylinder for each sensor.

1. See “Calibration Supplies and Equipment” on page 55 for a description of the necessary calibration supplies. In addition to an appropriate multi-gas cylinder that is used to calibrate any active standard channels, you will also need a cylinder to calibrate the infrared CO<sub>2</sub> channel. See Table 26 on page 213 for available cylinders. Make sure your calibration cylinder is appropriate for the infrared CO<sub>2</sub> detection range.
2. Find a fresh-air environment. This is an environment free of toxic or combustible gases and of normal oxygen content (20.9%).
3. While in Measuring Mode, press and hold the RANGE ▼ SHIFT button, then press the DISPLAY ADJUST NO button and release both buttons.
4. If the unit prompts you for the password, enter it by using the AIR ▲ YES and RANGE ▼ SHIFT buttons to select each password number and then pressing and releasing POWER ENTER RESET to enter the number and move on to the next one.

5. The Calibration Mode Screen displays with the cursor next to **AUTO CALIBRATION**.

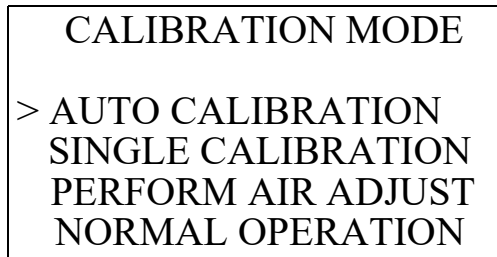

CALIBRATION MODE  
> AUTO CALIBRATION  
SINGLE CALIBRATION  
PERFORM AIR ADJUST  
NORMAL OPERATION

6. Move the cursor to the **PERFORM AIR ADJUST** menu item by using the RANGE ▼ SHIFT button.

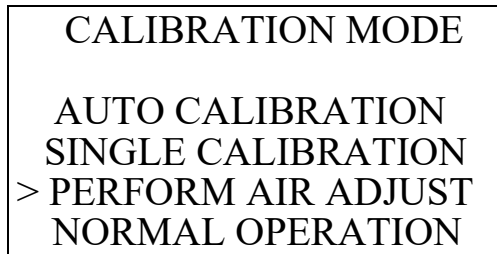

CALIBRATION MODE  
  
AUTO CALIBRATION  
SINGLE CALIBRATION  
> PERFORM AIR ADJUST  
NORMAL OPERATION

7. Remove the black caps from the ends of the carbon dioxide scrubber. Be sure to grab the scrubber by the EAGLE 2 fitting so that the fitting and tubing do not come off.
8. Attach the CO<sub>2</sub> scrubber to the inlet fitting of the EAGLE 2 and allow the instrument to draw gas for 1 minute before performing an air adjust.

**NOTE:** Attaching the CO<sub>2</sub> scrubber to the inlet fitting eliminates the background CO<sub>2</sub> found in fresh air and allows the EAGLE 2 to obtain an accurate zero reading.

9. Press and release the POWER ENTER RESET button. The following screen appears.

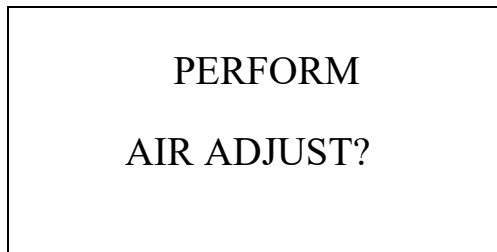

PERFORM  
AIR ADJUST?

10. Press and release the AIR ▲ YES button to continue.  
If you do not want to continue, press the DISPLAY ADJUST NO button and the unit will return to the Calibration Mode Screen.

11. The EAGLE 2 will indicate that it is adjusting the zero reading for a few seconds, then indicate that the operation is complete before returning to the Calibration Mode Screen.

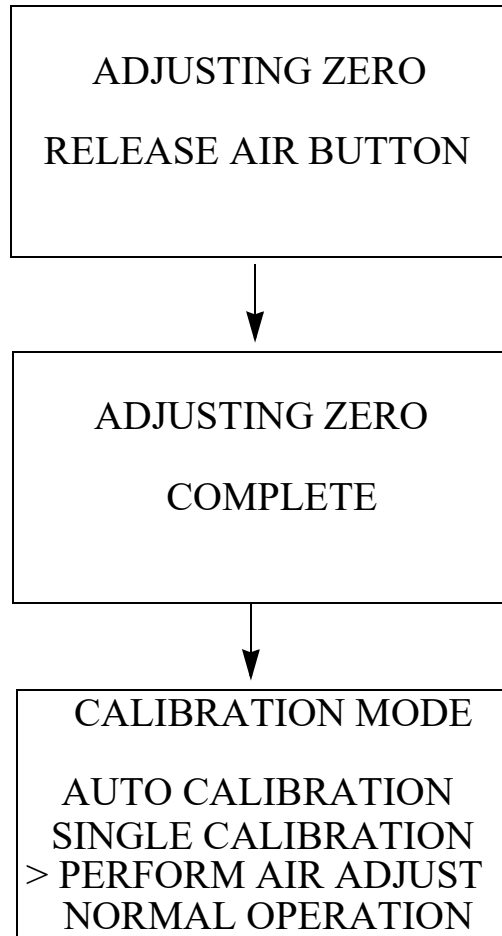

12. Remove the CO<sub>2</sub> scrubber from the EAGLE 2 inlet fitting.
13. Put the caps back on the scrubber.
14. Install the demand flow regulator onto the multi-gas calibration cylinder.
15. Connect the sample tubing to the demand flow regulator.
16. Install the probe on the EAGLE 2 inlet fitting. Make sure the probe is complete with internal O-ring and membrane and that the two halves of the probe are tightened firmly together to avoid leaks that can affect the calibration. See Figure 21, “Replacing the Particle Filter and Hydrophobic Filter Disk” on page 72 for an illustration of the internal parts of the probe.
17. Move the cursor next to the **AUTO CALIBRATION** menu item by using the AIR ▲ YES button.

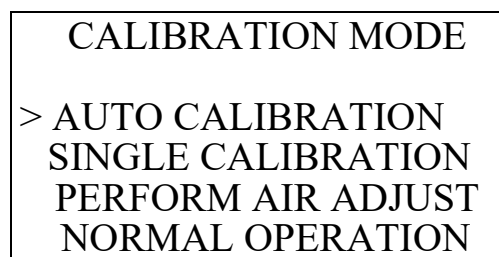

18. Press and release the POWER ENTER RESET button to display the Calibration Gas Values Screen.

CAL GAS VALUES		
CH4	50	%LEL
OXY	12.0	vol%
H2S	25.0	ppm
CO	50	ppm
ENTER TO BEGIN CAL		

The gas concentrations displayed in the Calibration Gas Values Screen must match the gas concentrations listed on the 4-gas calibration cylinder.

If *all* concentrations match, go to Step 27.

If *one or more* concentrations *do not* match, continue with Step 17.

If you do not want to continue with the calibration, press and release the DISPLAY ADJUST NO button to return to the Calibration Mode Screen.

**NOTE:** The RKI 4-gas cylinder typically contains 12% O<sub>2</sub> by volume. When using the auto calibration method, be sure to set the “OXY” auto calibration value to agree with the concentration listed on the cylinder’s label, not zero.

19. To adjust the values on the screen, press and hold the RANGE ▼ SHIFT button, then press the DISPLAY ADJUST NO button and release both. The following screen appears with the cursor next to **CH4**.

ADJUST AUTO		
CALIBRATION VALUES		
> CH4	50	%LEL
OXY	12.0	vol%
H2S	25.0	ppm
CO	50	ppm ▼

20. Place the cursor next to the channel whose gas value you want to change using the AIR ▲ YES and RANGE ▼ SHIFT buttons.
21. Press and release the POWER ENTER RESET button to select the channel. The calibration gas value begins to flash.
22. Use the AIR ▲ YES and RANGE ▼ SHIFT buttons to adjust the calibration gas setting to the desired value.

**NOTE:** The calibration gas value cannot be set lower than the low alarm setting. If the calibration gas value listed on the calibration cylinder is lower than the current low alarm setting, enter Setup Mode and change the low alarm setting. See “Updating the Alarm Point Settings” on page 106 for instructions. If you need to change the alarm point setting only to perform a calibration, make sure that you change the alarm point setting back to its original value once the calibration has been performed.

23. Press and release the POWER ENTER RESET button to save the change. The calibration gas value stops flashing.
24. Repeat Step 17 through Step 21 for any other channels that need to be changed.

25. When you are done adjusting the calibration gas values, move the cursor down past the bottom of the screen next to **END**.

```
ADJUST AUTO
CALIBRATION VALUES
> END ▲
```

26. Press and release the POWER ENTER RESET button. The following screen appears.

```
DO YOU WANT TO
STORE NEW VALUE(S)
IN MEMORY FOR
FUTURE CALIBRATIONS?

PRESS YES OR NO
```

27. If you select YES by pressing and releasing the AIR ▲ YES button, the changes that you made will be saved in the EAGLE 2's memory as the new auto calibration gas values.

If you select NO by pressing and releasing the DISPLAY ADJUST NO button, the changes you made will be used for any calibrations performed during the current operating session only. The EAGLE 2 will delete the changes when the unit is turned off and will load the previous set of auto calibration values when it is turned on again.

28. When you make your selection and press the desired button, the unit returns to the Calibration Gas Values Screen.

```
CAL GAS VALUES
CH4 50 %LEL
OXY 12.0 vol%
H2S 25.0 ppm
CO 50 ppm
ENTER TO BEGIN CAL
```

29. Press and release the POWER ENTER RESET button to proceed to the Calibration In Process Screen with **CAL IN PROCESS** flashing.

```
CAL IN PROCESS
CH4 0 %LEL
OXY 20.9 vol%
H2S 0.0 ppm
CO 0 ppm
ENTER WHEN DONE
```

If you do not want to proceed with the calibration, press and release the DISPLAY ADJUST NO button to return to the Cal Gas Values Screen.

If you do want to continue with the calibration, proceed to the next step.

30. Connect the tubing from the demand flow regulator to the rigid tube on the probe. Allow the EAGLE 2 to draw gas for one minute.
31. Press and release the POWER ENTER RESET button to set the span adjustment for each channel to the programmed values.
32. If all channels passed calibration, the following screen sequence occurs.

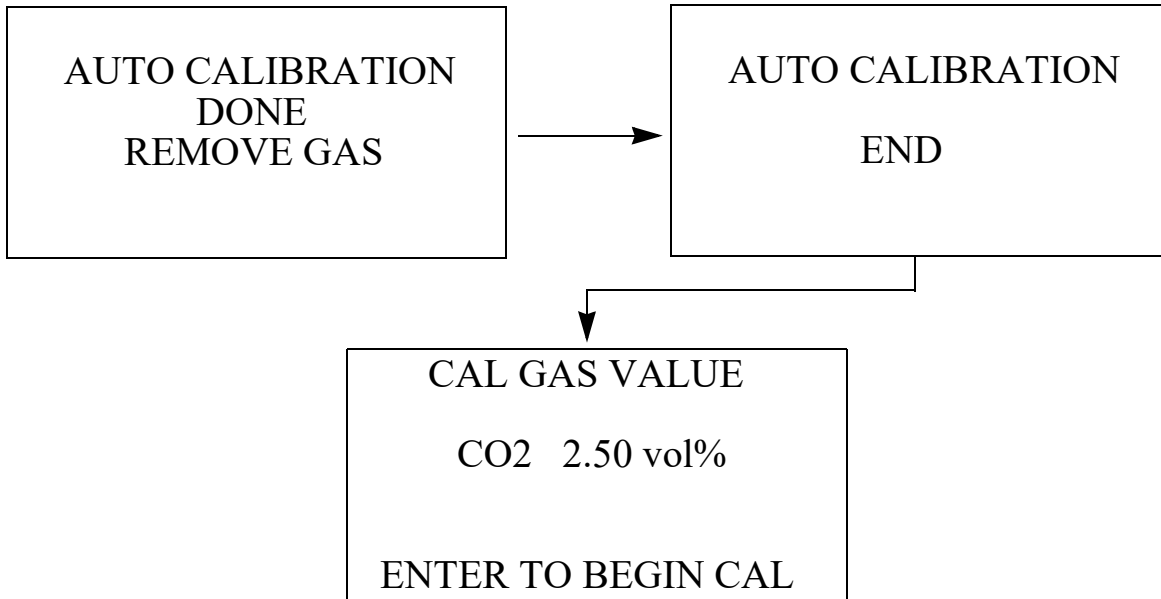

If any of the sensors cannot be adjusted to the proper value, a screen displays that indicates a calibration failure and lists the sensor(s) that failed to calibrate. In the example below, the oxygen and H<sub>2</sub>S channels failed calibration. The other sensors calibrated normally.

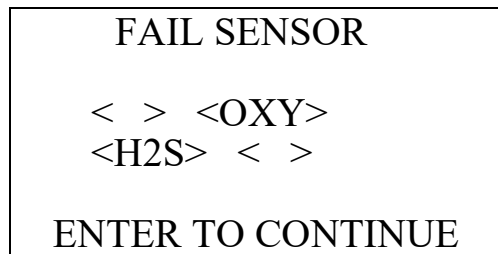

The buzzer and alarm LEDs activate in a double pulsing pattern. Press and release the POWER ENTER RESET button to reset the alarm and continue to the Calibration Value Screen for the infrared CO<sub>2</sub> channel. After calibrating the infrared CO<sub>2</sub> channel by following the instructions below, attempt to calibrate the standard channels again. If the failure continues, investigate the cause. See “Troubleshooting” on page 67.

33. Remove the tubing from the rigid tube on the probe.
34. Unscrew the 4-gas cylinder from the demand flow regulator.

35. If you want to change the infrared CO<sub>2</sub> channel's calibration gas value, follow Step 17 - Step 26 above beginning with the infrared CO<sub>2</sub> Calibration Gas Value Screen below instead of the standard channel Calibration Gas Value Screen.

<p style="text-align: center;"><b>CAL GAS VALUE</b></p> <p style="text-align: center;">CO<sub>2</sub> 2.50 vol%</p> <p style="text-align: center;">ENTER TO BEGIN CAL</p>
---

36. With the infrared CO<sub>2</sub> Calibration Gas Value Screen displayed, press and release the POWER ENTER RESET button to proceed to the Calibration In Process Screen for the infrared CO<sub>2</sub> channel with **CAL IN PROCESS** flashing.

<p style="text-align: center;"><b>CAL IN PROCESS</b></p> <p style="text-align: center;">CO<sub>2</sub> 0.00 vol%</p> <p style="text-align: center;">ENTER WHEN DONE</p>
---

If you do not want to proceed with the calibration, press and release the DISPLAY ADJUST NO button to return to the infrared CO<sub>2</sub> Cal Gas Values Screen.

If you do want to continue with the calibration, proceed to the next step.

37. Screw the infrared CO<sub>2</sub> calibration cylinder onto the demand flow regulator.
38. Connect the tubing from the regulator to the rigid tube on the probe. Allow the EAGLE 2 to draw gas for the appropriate time shown in the table below.

**Table 25: IR CO<sub>2</sub> Sensor Calibration Times**

Range	Calibration Time
0-5.00 %vol	1 minute
0-10,000 ppm	90 seconds
0-60.0 %vol	90 seconds

39. Press and release the POWER ENTER RESET button to set the span adjustment for the infrared CO<sub>2</sub> channel to the programmed value.

40. If the infrared CO<sub>2</sub> channel passed calibration, the following screen sequence occurs.

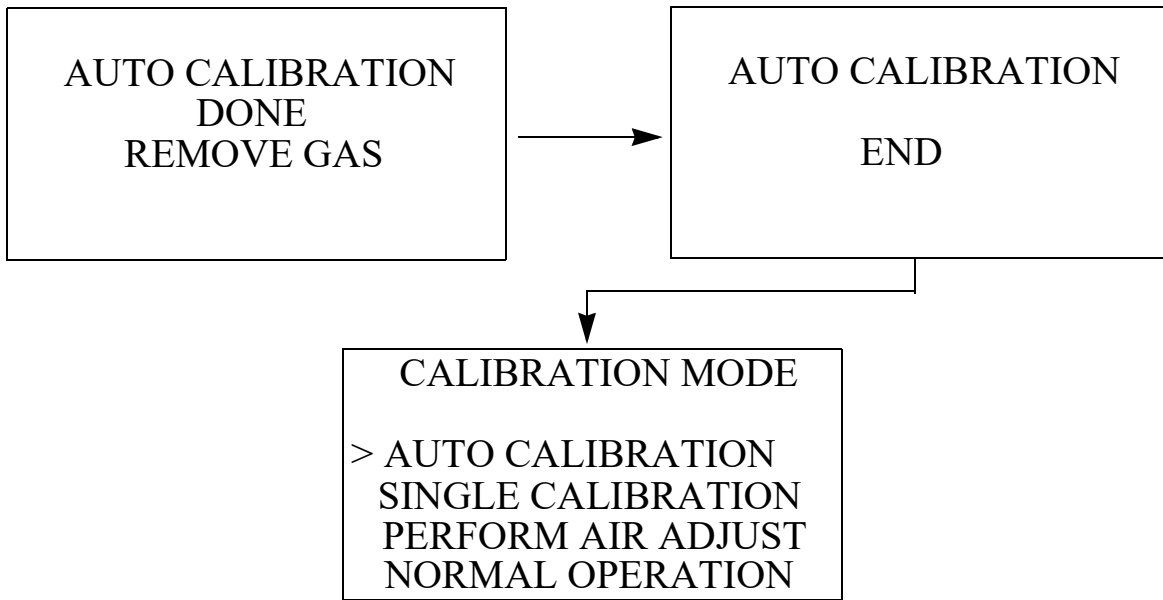

If the infrared CO<sub>2</sub> channel cannot be adjusted to the proper value, a screen displays that indicates a calibration failure and indicates that the infrared CO<sub>2</sub> sensor failed to calibrate.

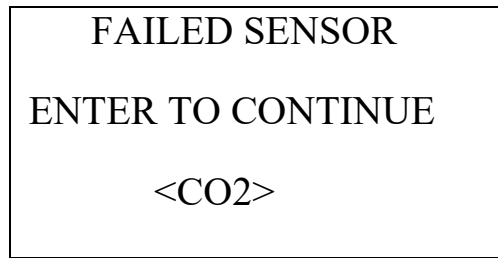

The buzzer and alarm LEDs activate in a double pulsing pattern. Press and release the POWER ENTER RESET button to reset the alarm and continue to the Calibration Mode Screen. Attempt to calibrate the infrared CO<sub>2</sub> channel again. If the failure continues, investigate the cause. See “Troubleshooting” on page 67.

41. Disconnect the tubing from the probe.
42. Unscrew the demand flow regulator from the calibration cylinder.
43. Use the RANGE ▼ SHIFT button to place the cursor next to the **NORMAL OPERATION** menu option, then press and release the POWER ENTER RESET button to return to Measuring Mode.

---

## Maintenance

This section includes a procedure for replacing an infrared CO<sub>2</sub> sensor.

### Replacing the IR CO<sub>2</sub> Sensor or Changing Sensor Type

1. Verify that the EAGLE 2 is off.
2. Place the EAGLE 2 upside down on a flat surface or hold it upside down.
3. Unscrew the three case screws until they disengage from the top case. They are captive screws so they will not fall off of the bottom case.
4. Turn the EAGLE 2 right side up and carefully lift the top case away from the bottom case. Be careful not to lift it so far that it pulls on the main PCB with the cable that connects the top case to the main PCB.
5. Lay the top case down next to the bottom case to allow access to the flow system.
6. Locate the infrared CO<sub>2</sub> sensor. It has a twelve wire cable with a connector that mates to an infrared sub PCB that is installed on the main PCB and is normally located next to the pump. Figure 40 on page 201 shows an infrared CO<sub>2</sub> sensor in a typical location.
7. Unscrew and remove the two screws that hold down the infrared CO<sub>2</sub> sensor bracket.
8. Grasp the sensor firmly and pull it out of the infrared CO<sub>2</sub> flow chamber. Rock it back and forth gently if necessary to pull it out. Take care not to pull the cable from the sub PCB.
9. Rotate the locking lever counterclockwise on the cable connector that mates to the infrared CO<sub>2</sub> sensor to unlock it.
10. Unplug the old infrared CO<sub>2</sub> sensor from the cable.

11. Connect the new infrared CO<sub>2</sub> sensor to the sensor cable and rotate the locking lever clockwise to lock the connector.
12. Insert the sensor into the infrared CO<sub>2</sub> flow chamber and push it in until it bottoms out.
13. Line up the holes in the infrared CO<sub>2</sub> sensor bracket with the two standoffs on the infrared CO<sub>2</sub> chamber.
14. Install the two sensor bracket screws.
15. Confirm that the main PCB is seated in its slots and that its bottom edge is resting on the bottom of the bottom case. If the main PCB is not seated properly, it may be damaged when the top case is re-installed.
16. Make sure that the top case gasket is fully seated in its groove and carefully put the top case back on the bottom case. If you have any difficulty mating the top and bottom cases, inspect the placement of the main PCB and the placement of the top case gasket.
17. Turn the EAGLE 2 upside down and tighten the three case screws to secure the top case to the bottom case.
18. Calibrate the infrared CO<sub>2</sub> channel as described in “Infrared CO<sub>2</sub> Calibration” on page 203.

## Parts List

**Table 26: Infrared CO<sub>2</sub> EAGLE 2 Parts List**

<b>Part Number</b>	<b>Description</b>
33-6010RK-01	CO <sub>2</sub> scrubber
47-5051RK	Infrared CO <sub>2</sub> sensor cable
DEM-3313-1	Infrared CO <sub>2</sub> sensor, 0-5 %vol
DEM-3313-4	Infrared CO <sub>2</sub> sensor, 0-10,000 ppm
DEM-3313-5	Infrared CO <sub>2</sub> sensor, 0-60 %vol
81-0071RK-01	Calibration cylinder, 5000 ppm CO <sub>2</sub> in nitrogen, 34 liter
81-0071RK-03	Calibration cylinder, 5000 ppm CO <sub>2</sub> in nitrogen, 103 liter
81-0072RK-01	Calibration cylinder, 2.5 %vol CO <sub>2</sub> in nitrogen, 34 liter
81-0072RK-03	Calibration cylinder, 2.5 %vol CO <sub>2</sub> in nitrogen, 103 liter
81-0073RK-01	Calibration cylinder, 15 %vol CO <sub>2</sub> in nitrogen, 34 liter
81-0073RK-03	Calibration cylinder, 15 %vol CO <sub>2</sub> in nitrogen, 103 liter

# Appendix H: Infrared Methane Sensor

## Overview

This appendix describes the EAGLE 2's infrared methane sensors and includes instructions to use an EAGLE 2 that has an infrared methane sensor installed. It also includes instructions to replace an infrared methane sensor.

**Table 27: Infrared Methane Sensor Specifications, %LEL Configuration**

Range	Increment	Alarm 1	Alarm 2	STEL	TWA
0-100 %LEL CH <sub>4</sub>	1 %LEL	10 %LEL	50 %LEL	N/A	N/A

**Table 28: Infrared Methane Sensor Specifications, Autoranging Configuration**

Range	Increment	Alarm 1	Alarm 2	STEL	TWA
0-100 %LEL CH <sub>4</sub>	1 %LEL	10 %LEL	50 %LEL	N/A	N/A
5.0-100.0 %vol CH <sub>4</sub>	0.5 %vol	OFF	OFF	N/A	N/A

**Table 29: Infrared Methane Sensor Specification, %Volume Configuration**

Range	Increment	Alarm 1	Alarm 2	STEL	TWA
0-100.0 %vol CH <sub>4</sub>	0.5 %vol	OFF	OFF	N/A	N/A

## Target Gases

The infrared methane sensor is setup for and factory-calibrated to methane. There are gases that the sensor will still detect and respond to. There are also gases that the methane sensor will not detect or respond to. Lists of the gases falling in each of these respective categories can be found below. Consult RKI Instruments, Inc. for combustible gases not listed below.

The infrared methane sensor is known to respond to the following combustible gases:

- ethane
- hexane
- IPA
- isobutane
- MEK
- propane
- styrene
- toluene

The infrared methane sensor is known to **not** or to poorly respond to the following combustible gases:

- acetylene
- benzene
- hydrogen

## Description

Table 27 and Table 28 above list the available infrared methane sensor configurations. The infrared methane sensor is a smart sensor that stores the target gas.

### Top Case Not Shown

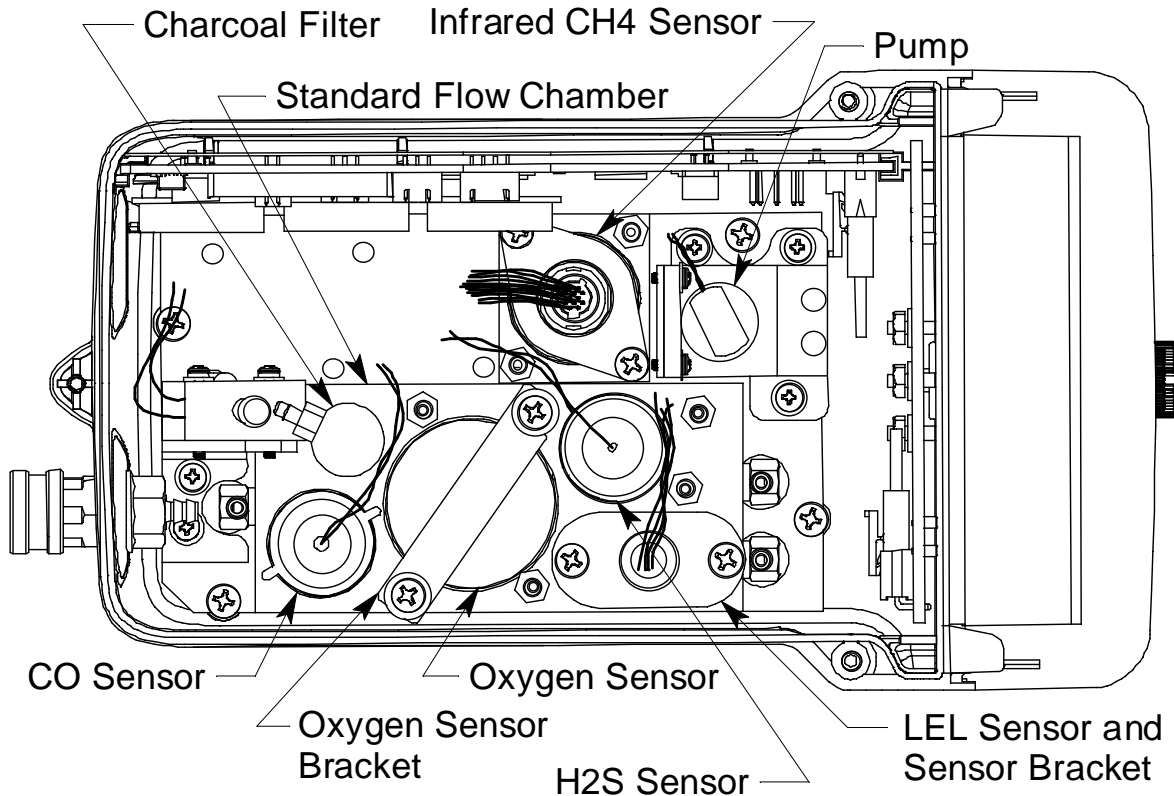

**Figure 42: Typical Infrared Methane Sensor Location**

The infrared methane sensor is installed in a single sensor flow chamber which is located in the area next to the standard 4-sensor flow chamber. This area can accommodate up to three single sensor flow chambers. Figure 42 above illustrates a typical infrared methane sensor location in front of the pump. The infrared methane flow chamber may also be installed in one of the other two sensor chamber locations depending on the particular version of the EAGLE 2. Some infrared methane instrument configurations do not include the 4-sensor flow chamber.

### **Infrared Methane Sensor**

The infrared methane sensor is a cylindrical sensor with a diffusion opening on the front and a 12 pin circular connector on the back. A 12 wire cable plugs into the back of the infrared methane sensor with a circular connector that includes a locking lever. The other end of the cable plugs into an infrared sub PCB (see description below) that is installed on the main PCB. The sensor is held in the infrared flow chamber by a bracket on standoffs.

## Infrared Sub PCB

The infrared sub PCB is a circuit board that is installed on the main PCB in one of the 3 sub PCB positions when an infrared methane sensor is used with the EAGLE 2. The infrared methane sensor connects to the sub PCB with a 12-position connector. The sub PCB plugs into the main PCB and is held in place with a screw/flat washer/lock washer. There are no user serviceable parts on the infrared sub PCB.

---

## Start Up and Normal Operation

For instructions to startup and use an EAGLE 2 that includes an infrared methane sensor, reference “Start Up” on page 27, “Measuring Mode, Normal Operation” on page 33, and “Measuring Mode, Alarms” on page 38.

### Detection Ranges

The infrared methane sensor can be factory set to detect gas in a 0-100 %LEL configuration, an autoranging configuration, or a 0 - 100.0 %volume configuration. The autoranging configuration detects gas on a 0-100 %LEL and a 5.0-100.0 %vol scale. The gas reading will be displayed in %LEL until the gas level reaches 100 %LEL, or 5.0 %vol for methane. Once the gas reading is above 100 %LEL, it is displayed in %vol. Alarm points exist for the %LEL range but do not exist for the %vol range.

---

## Catalytic (LEL) Sensor Screen

When either a TC sensor or an infrared combustible sensor is installed in an EAGLE 2 along with a catalytic combustible LEL sensor, the user has the option of turning off the catalytic combustible LEL sensor in Display Mode. If the unit is going to be used for sampling known high-levels of combustible gas or in areas with known catalytic sensor poisons such as silicone vapors, the catalytic combustible sensor should be turned off. Even though this sensor has its own protective shut off, exposure to high levels of combustible gas can still stress the catalytic LEL sensor. The catalytic LEL sensor can be enabled or disabled in the Catalytic (LEL) Sensor screen in Display Mode. The default setting is enabled. To change the setting, do the following:

**NOTE:** The Catalytic (LEL) Sensor setting is reset when the EAGLE 2 is turned off. When the EAGLE 2 is turned on, this setting is always ENABLED.

1. Use the DISPLAY ADJUST NO button to enter Display Mode and scroll to the Catalytic (LEL) Sensor screen. The current setting will be flashing.

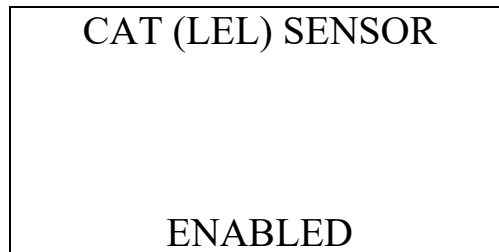

2. Use the AIR ▲ YES or RANGE ▼ SHIFT button to toggle to the desired setting. If set to DISABLED, the gas readings for the catalytic LEL channel will be replaced by dashes (---).

3. Press and release POWER ENTER RESET to save the setting and return to the main menu.
4. Use the DISPLAY ADJUST NO button to scroll through the rest of Display Mode and enter Normal Operation.

---

## Infrared Methane Calibration

An infrared methane channel can be calibrated using the auto calibration method or the single calibration method. To calibrate an infrared methane channel using the single calibration method, see “Calibrating Using the Single Calibration Method” on page 62 and follow the instructions for calibrating a single channel. If your instrument is a multi-channel instrument that includes an infrared methane channel, RKI Instruments, Inc. recommends using the auto calibration method for convenience. The calibration instructions below show a 5 channel instrument which has the four standard channels, LEL/oxygen/H<sub>2</sub>S/CO, and an infrared methane channel configured for autoranging.

The standard factory calibration for the autoranging infrared methane sensor is to 50 %LEL. If your instrument is configured for autoranging and you need maximum accuracy in the %vol range, the sensor may be calibrated to 50 %vol.

To use the auto calibration method to calibrate a multi-channel instrument that includes an infrared methane channel, do the following:

1. See “Calibration Supplies and Equipment” on page 55 for a description of the necessary calibration supplies. In addition to an appropriate multi-gas cylinder that is used to calibrate any active standard channels, you will also need a cylinder to calibrate the infrared methane channel. See Table 30 on page 225 for available cylinders. Make sure your calibration cylinder is appropriate for the infrared methane detection range.
2. Find a fresh-air environment. This is an environment free of toxic or combustible gases and of normal oxygen content (20.9%).
3. While in Measuring Mode, press and hold the RANGE ▼ SHIFT button, then press the DISPLAY ADJUST NO button and release both buttons.
4. If the unit prompts you for the password, enter it by using the AIR ▲ YES and RANGE ▼ SHIFT buttons to select each password number and then pressing and releasing POWER ENTER RESET to enter the number and move on to the next one.
5. The Calibration Mode Screen displays with the cursor next to **AUTO CALIBRATION**.

<p>CALIBRATION MODE</p> <p>&gt; AUTO CALIBRATION</p> <p>SINGLE CALIBRATION</p> <p>PERFORM AIR ADJUST</p> <p>NORMAL OPERATION</p>
--

6. Move the cursor to the **PERFORM AIR ADJUST** menu item by using the RANGE ▼ SHIFT button.

CALIBRATION MODE  
AUTO CALIBRATION  
SINGLE CALIBRATION  
> PERFORM AIR ADJUST  
NORMAL OPERATION

7. Press and release the POWER ENTER RESET button. The following screen appears.

PERFORM  
AIR ADJUST?

8. Press and release the AIR ▲ YES button to continue.  
If you do not want to continue, press the DISPLAY ADJUST NO button and the unit will return to the Calibration Mode Screen.
9. The EAGLE 2 will indicate that it is adjusting the zero reading for a few seconds, then indicate that the operation is complete before returning to the Calibration Mode Screen.

ADJUSTING ZERO  
RELEASE AIR BUTTON



ADJUSTING ZERO  
COMPLETE



CALIBRATION MODE  
AUTO CALIBRATION  
SINGLE CALIBRATION  
> PERFORM AIR ADJUST  
NORMAL OPERATION

10. Install the demand flow regulator onto the multi-gas calibration cylinder.
11. Connect the sample tubing to the demand flow regulator.
12. Install the probe on the EAGLE 2 inlet fitting. Make sure the probe is complete with internal O-ring and membrane and that the two halves of the probe are tightened firmly together to avoid leaks that can affect the calibration. See Figure 21, “Replacing the Particle Filter and Hydrophobic Filter Disk” on page 72 for an illustration of the internal parts of the probe.
13. Move the cursor next to the **AUTO CALIBRATION** menu item by using the AIR ▲ YES button.

```

CALIBRATION MODE
> AUTO CALIBRATION
  SINGLE CALIBRATION
  PERFORM AIR ADJUST
  NORMAL OPERATION
  
```

14. Press and release the POWER ENTER RESET button to display the Calibration Gas Values Screen.

```

CAL GAS VALUES
CH4  50 %LEL
OXY  12.0 vol%
H2S  25.0 ppm
CO   50 ppm
ENTER TO BEGIN CAL
  
```

The gas concentrations displayed in the Calibration Gas Values Screen must match the gas concentrations listed on the 4-gas calibration cylinder.

If *all* concentrations match, go to Step 25.

If *one or more* concentrations *do not* match, continue with Step 15.

If you do not want to continue with the calibration, press and release the DISPLAY ADJUST NO button to return to the Calibration Mode Screen.

**NOTE:** The RKI 4-gas cylinder typically contains 12% O<sub>2</sub> by volume. When using the auto calibration method, be sure to set the “OXY” auto calibration value to agree with the concentration listed on the cylinder’s label, not zero.

15. To adjust the values on the screen, press and hold the RANGE ▼ SHIFT button, then press the DISPLAY ADJUST NO button and release both. The following screen appears with the cursor next to **CH4**.

```

ADJUST AUTO
CALIBRATION VALUES
> CH4  50 %LEL
  OXY  12.0 vol%
  H2S  25.0 ppm
  CO   50 ppm ▼
  
```

16. Place the cursor next to the channel whose gas value you want to change using the AIR ▲ YES and RANGE ▼ SHIFT buttons.

17. Press and release the POWER ENTER RESET button to select the channel. The calibration gas value begins to flash.
18. Use the AIR ▲ YES and RANGE ▼ SHIFT buttons to adjust the calibration gas setting to the desired value.

**NOTE:** The calibration gas value cannot be set lower than the low alarm setting. If the calibration gas value listed on the calibration cylinder is lower than the current low alarm setting, enter Setup Mode and change the low alarm setting. See “Updating the Alarm Point Settings” on page 106 for instructions. If you need to change the alarm point setting only to perform a calibration, make sure that you change the alarm point setting back to its original value once the calibration has been performed.

19. Press and release the POWER ENTER RESET button to save the change. The calibration gas value stops flashing.
20. Repeat Step 16 through Step 19 for any other channels that need to be changed.
21. When you are done adjusting the calibration gas values, move the cursor down past the bottom of the screen next to **END**.

ADJUST AUTO  
CALIBRATION VALUES  
> END ▲

22. Press and release the POWER ENTER RESET button. The following screen appears.

DO YOU WANT TO  
STORE NEW VALUE(S)  
IN MEMORY FOR  
FUTURE CALIBRATIONS?  
  
PRESS YES OR NO

23. If you select YES by pressing and releasing the AIR ▲ YES button, the changes that you made will be saved in the EAGLE 2's memory as the new auto calibration gas values.

If you select NO by pressing and releasing the DISPLAY ADJUST NO button, the changes you made will be used for any calibrations performed during the current operating session only. The EAGLE 2 will delete the changes when the unit is turned off and will load the previous set of auto calibration values when it is turned on again.

24. When you make your selection and press the desired button, the unit returns to the Calibration Gas Values Screen.

```
CAL GAS VALUES
CH4  50 %LEL
OXY  12.0 vol%
H2S  25.0 ppm
CO   50 ppm
ENTER TO BEGIN CAL
```

25. Press and release the POWER ENTER RESET button to proceed to the Calibration In Process Screen with **CAL IN PROCESS** flashing.

```
CAL IN PROCESS
CH4   0 %LEL
OXY  20.9 vol%
H2S   0.0 ppm
CO    0 ppm
ENTER WHEN DONE
```

If you do not want to proceed with the calibration, press and release the DISPLAY ADJUST NO button to return to the Cal Gas Values Screen.

If you do want to continue with the calibration, proceed to the next step.

26. Connect the tubing from the demand flow regulator to the rigid tube on the probe. Allow the EAGLE 2 to draw gas for one minute.
27. Press and release the POWER ENTER RESET button to set the span adjustment for each channel to the programmed values.
28. If all channels passed calibration, the following screen sequence occurs.

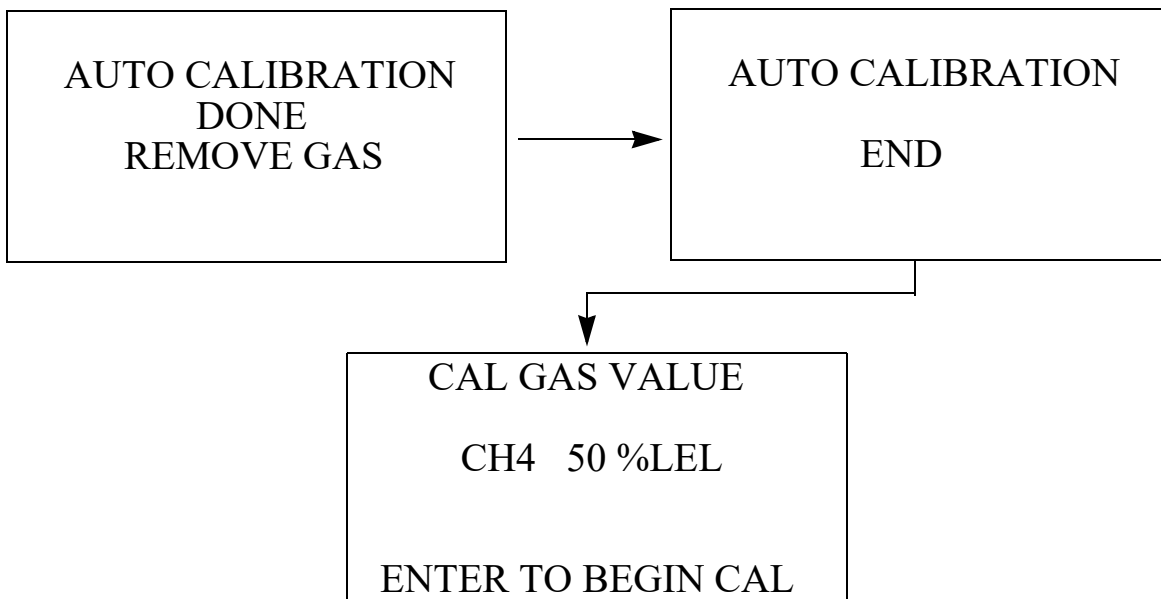

If any of the sensors cannot be adjusted to the proper value, a screen displays that indicates a calibration failure and lists the sensor(s) that failed to calibrate. In the example below, the oxygen and H<sub>2</sub>S channels failed calibration. The other sensors calibrated normally.

FAIL SENSOR  
  
< > <OXY>  
<H2S> < >  
  
ENTER TO CONTINUE

The buzzer and alarm LEDs activate in a double pulsing pattern. Press and release the POWER ENTER RESET button to reset the alarm and continue to the Calibration Value Screen for the infrared methane channel. After calibrating the infrared methane channel by following the instructions below, attempt to calibrate the standard channels again. If the failure continues, investigate the cause. See “Troubleshooting” on page 67.

29. Remove the tubing from the rigid tube on the probe.
30. Unscrew the 4-gas cylinder from the demand flow regulator.
31. If you want to change the infrared methane channel’s calibration gas value, follow Step 15 - Step 24 above beginning with the infrared methane Calibration Gas Value Screen below instead of the standard channel Calibration Gas Value Screen.

CAL GAS VALUE  
  
CH4 50 %LEL  
  
ENTER TO BEGIN CAL

32. With the infrared methane Calibration Gas Value Screen displayed, press and release the POWER ENTER RESET button to proceed to the Calibration In Process Screen for the infrared methane channel with **CAL IN PROCESS** flashing.

CAL IN PROCESS  
  
CH4 0 %LEL  
  
ENTER WHEN DONE

If you do not want to proceed with the calibration, press and release the DISPLAY ADJUST NO button to return to the infrared methane Cal Gas Values Screen.

If you do want to continue with the calibration, proceed to the next step.

33. Screw the infrared methane calibration cylinder onto the demand flow regulator.
34. Connect the tubing from the regulator to the rigid tube on the probe. Allow the EAGLE 2 to draw gas for 90 seconds.
35. Press and release the POWER ENTER RESET button to set the span adjustment for the infrared methane channel to the programmed value.

36. If the infrared methane channel passed calibration, the following screen sequence occurs.

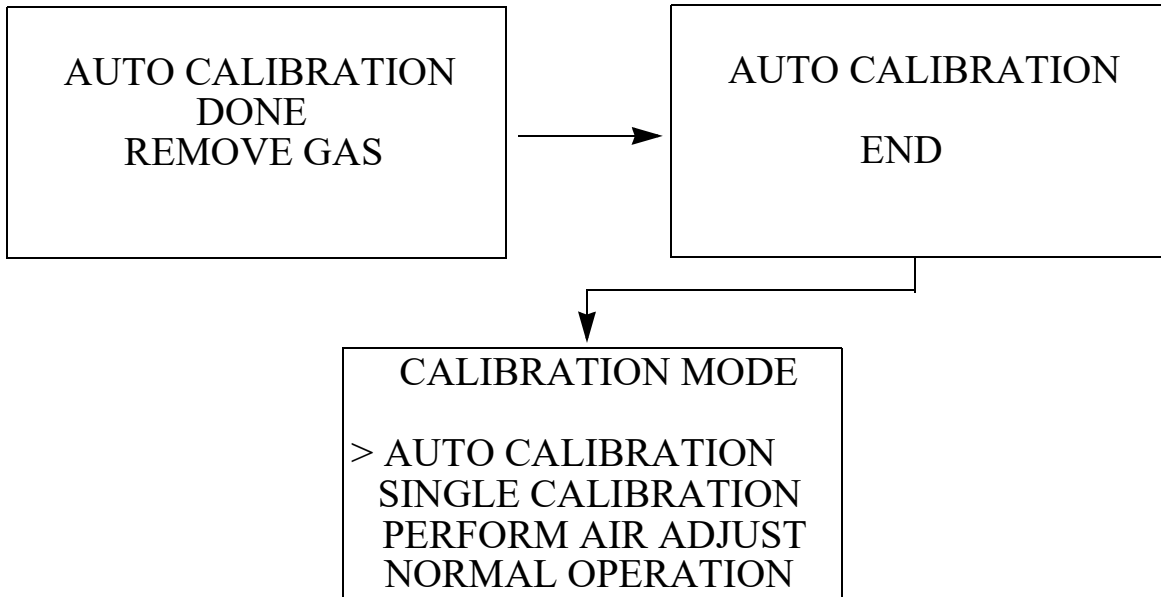

If the infrared methane channel cannot be adjusted to the proper value, a screen displays that indicates a calibration failure and indicates that the infrared methane sensor failed to calibrate.

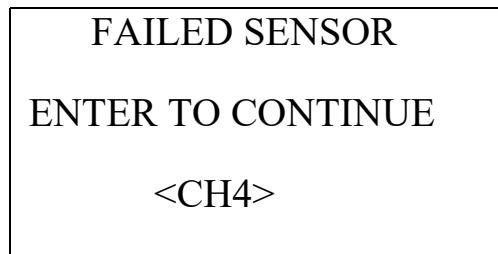

The buzzer and alarm LEDs activate in a double pulsing pattern. Press and release the POWER ENTER RESET button to reset the alarm and continue to the Calibration Mode Screen. Attempt to calibrate the infrared methane channel again. If the failure continues, investigate the cause. See "Troubleshooting" on page 67.

37. Disconnect the tubing from the probe.
38. Unscrew the demand flow regulator from the calibration cylinder.
39. Use the RANGE ▼ SHIFT button to place the cursor next to the **NORMAL OPERATION** menu option, then press and release the POWER ENTER RESET button to return to Measuring Mode.

---

## Maintenance

This section includes a procedure to replace an infrared methane sensor.

### Replacing the IR Methane Sensor

1. Verify that the EAGLE 2 is off.
2. Place the EAGLE 2 upside down on a flat surface or hold it upside down.
3. Unscrew the three case screws until they disengage from the top case. They are captive screws so they will not fall off of the bottom case.
4. Turn the EAGLE 2 right side up and carefully lift the top case away from the bottom case. Be careful not to lift it so far that it pulls on the main PCB with the cable that connects the top case to the main PCB.
5. Lay the top case down next to the bottom case to allow access to the flow system.
6. Locate the infrared methane sensor. It has a twelve wire cable with a connector that mates to an infrared sub PCB that is installed on the main PCB and is normally located next to the pump. Figure 42 on page 215 shows an infrared methane sensor in a typical location.
7. Unscrew and remove the two screws that hold down the infrared methane sensor bracket.
8. Grasp the sensor firmly and pull it out of the infrared methane flow chamber. Rock it back and forth gently if necessary to pull it out. Take care not to pull the cable from the sub PCB.
9. Rotate the locking lever counterclockwise on the cable connector that mates to the infrared methane sensor to unlock it.
10. Unplug the old infrared methane sensor from the cable.
11. Connect the new infrared methane sensor to the sensor cable and rotate the locking lever clockwise to lock the connector.
12. Insert the sensor into the infrared methane flow chamber and push it in until it bottoms out.
13. Line up the holes in the infrared methane sensor bracket with the two standoffs on the infrared methane chamber.
14. Install the two sensor bracket screws.
15. Confirm that the main PCB is seated in its slots and that its bottom edge is resting on the bottom of the bottom case. If the main PCB is not seated properly, it may be damaged when the top case is re-installed.
16. Make sure that the top case gasket is fully seated in its groove and carefully put the top case back on the bottom case. If you have any difficulty mating the top and bottom cases, inspect the placement of the main PCB and the placement of the top case gasket.
17. Turn the EAGLE 2 upside down and tighten the three case screws to secure the top case to the bottom case.
18. Calibrate the infrared methane channel as described in “Infrared Methane Calibration” on page 217.

---

## Parts List

**Table 30: Infrared CH<sub>4</sub> EAGLE 2 Parts List**

<b>Part Number</b>	<b>Description</b>
47-5051RK	Infrared CH <sub>4</sub> sensor cable
DEM-3313-3	Infrared CH <sub>4</sub> sensor, 0-100 %LEL or 0-100 %LEL/5.0-100.0 %vol autoranging
81-0012RK-01	Calibration cylinder, 50 %LEL CH <sub>4</sub> in air, 34 liter steel
81-0012RK-03	Calibration cylinder, 50 %LEL CH <sub>4</sub> in air, 103 liter steel
81-0013RK-01	Calibration cylinder, 50 %vol CH <sub>4</sub> in N <sub>2</sub> , 34 liter steel
81-0013RK-05	Calibration cylinder, 50 %vol CH <sub>4</sub> in N <sub>2</sub> , 58 liter steel

# Appendix I: Infrared Hydrocarbon Sensor

---

## Overview

This appendix describes the EAGLE 2's infrared hydrocarbon sensor and includes instructions to use an EAGLE 2 that has an infrared hydrocarbon sensor installed. It also includes instructions to replace an infrared hydrocarbon sensor.

**Table 31: Infrared Hydrocarbon Sensor Specifications, %LEL Configuration**

Range	Increment	Alarm 1	Alarm 2	STEL	TWA
0-100 %LEL HC	1 %LEL	10 %LEL	50 %LEL	N/A	N/A

**Table 32: Infrared Hydrocarbon Sensor Specifications, Autoranging Configuration**

Range	Increment	Alarm 1	Alarm 2	STEL	TWA
0-100 %LEL HC	1 %LEL	10 %LEL	50 %LEL	N/A	N/A
2.0-30.0 %vol HC	0.5 %vol	N/A	N/A	N/A	N/A

**NOTE:** The gas name on the infrared hydrocarbon channel will normally read "HC". However, depending on the instrument's shipment date and any special requirements, your instrument may read "IBU" or some other gas name.

### Target Gases

The infrared HC sensor is a general hydrocarbon sensor. It is setup for and factory-calibrated to isobutane.

---

## Description

Table 31 and Table 32 above list the available infrared hydrocarbon sensor configurations. The infrared hydrocarbon sensor is a smart sensor that stores the target gas. The infrared hydrocarbon sensor is installed in a single sensor flow chamber which is located in the area next to the standard 4-sensor flow chamber. This area can accommodate up to three single sensor flow chambers. Figure 43 above illustrates a typical infrared hydrocarbon sensor location in front of the pump. The infrared hydrocarbon flow chamber may also be installed in one of the other two sensor chamber locations depending on the particular version of the EAGLE 2. Some infrared hydrocarbon instrument configurations do not include the 4-sensor flow chamber.

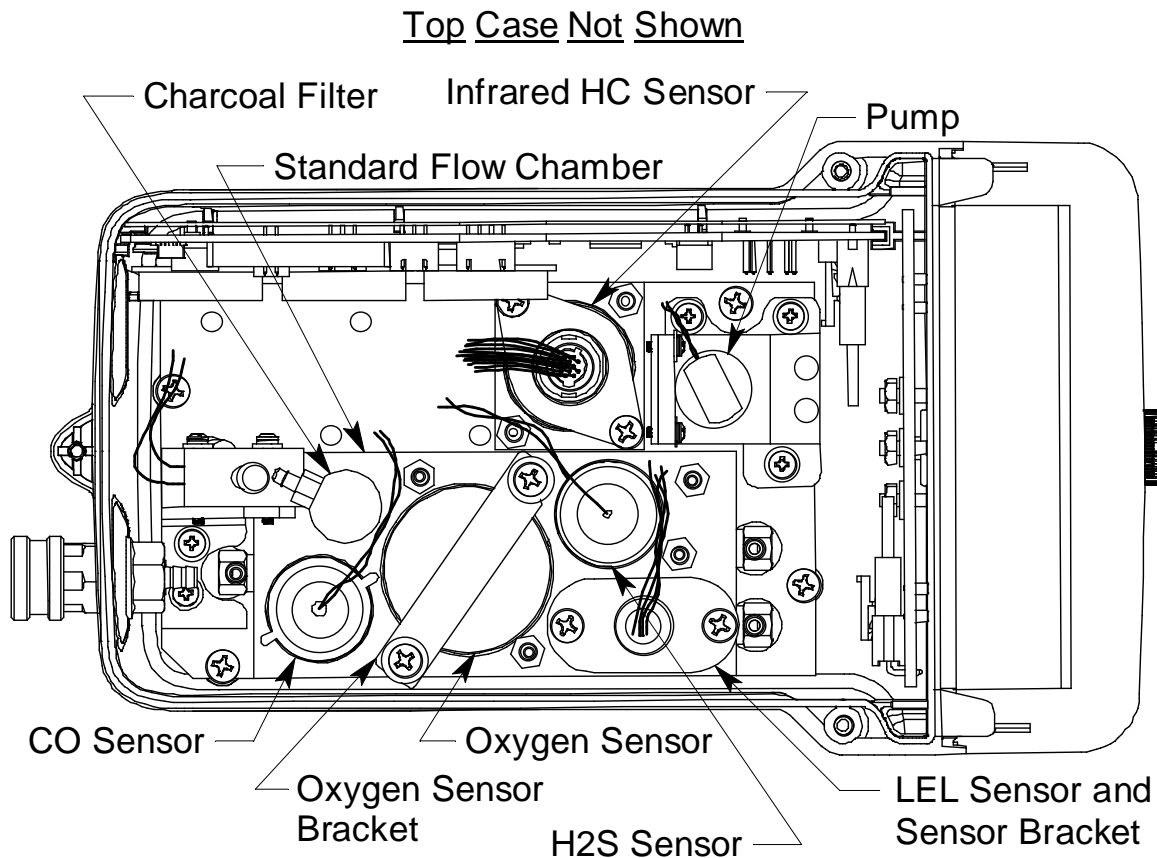

**Figure 43: Typical Infrared Hydrocarbon Sensor Location**

### **Infrared Hydrocarbon Sensor**

The infrared hydrocarbon sensor is a cylindrical sensor with a diffusion opening on the front and a 12 pin circular connector on the back. A 12 wire cable plugs into the back of the infrared hydrocarbon sensor with a circular connector that includes a locking lever. The other end of the cable plugs into an infrared sub PCB (see description below) that is installed on the main PCB. The sensor is held in the infrared flow chamber by a bracket on standoffs.

### **Infrared Sub PCB**

The infrared sub PCB is a circuit board that is installed on the main PCB in one of the 3 sub PCB positions when an infrared hydrocarbon sensor is used with the EAGLE 2. The infrared hydrocarbon sensor connects to the sub PCB with a 12-position connector. The sub PCB plugs into the main PCB and is held in place with a screw/flat washer/lock washer. There are no user serviceable parts on the infrared sub PCB.

## **Start Up and Normal Operation**

For instructions to startup and use an EAGLE 2 that includes an infrared hydrocarbon sensor, reference “Start Up” on page 27, “Measuring Mode, Normal Operation” on page 33, and “Measuring Mode, Alarms” on page 38.

### **0-100 %LEL/2.0-30.0 %vol Autoranging**

The infrared hydrocarbon sensor can be factory set to detect gas in a 0-100 %LEL configuration or an autoranging configuration. The autoranging configuration detects gas

on a 0-100 %LEL and a 2.0-30.0 %vol scale. The gas reading will be displayed in %LEL until the gas level reaches 100 %LEL, or 2.0 %vol for isobutane. Once the gas reading is above 100 %LEL, it is displayed in %vol. Alarm points exist for the %LEL range but do not exist for the %vol range.

---

## Catalytic (LEL) Sensor Screen

When either a TC sensor or an infrared combustible sensor is installed in an EAGLE 2 along with a catalytic combustible LEL sensor, the user has the option of turning off the catalytic combustible LEL sensor in Display Mode. If the unit is going to be used for sampling known high-levels of combustible gas or in areas with known catalytic sensor poisons such as silicone vapors, the catalytic combustible sensor should be turned off. Even though this sensor has its own protective shut off, exposure to high levels of combustible gas can still stress the catalytic LEL sensor. The catalytic LEL sensor can be enabled or disabled in the Catalytic (LEL) Sensor screen in Display Mode. The default setting is enabled. To change the setting, do the following:

**NOTE:** The Catalytic (LEL) Sensor setting is reset when the EAGLE 2 is turned off. When the EAGLE 2 is turned on, this setting is always ENABLED.

1. Use the DISPLAY ADJUST NO button to enter Display Mode and scroll to the Catalytic (LEL) Sensor screen. The current setting will be flashing.

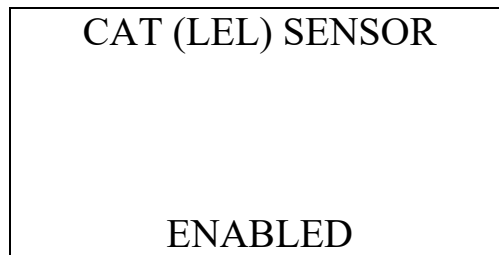

2. Use the AIR ▲ YES or RANGE ▼ SHIFT button to toggle to the desired setting. If set to DISABLED, the gas reading for the catalytic LEL channel will be replaced by dashes (---).
3. Press and release POWER ENTER RESET to save the setting and return to the main menu.
4. Use the DISPLAY ADJUST NO button to scroll through the rest of Display Mode and enter Normal Operation.

---

## Infrared Hydrocarbon Calibration

An infrared hydrocarbon channel can be calibrated using the auto calibration method or the single calibration method. To calibrate an infrared hydrocarbon channel using the single calibration method, see “Calibrating Using the Single Calibration Method” on page 62 and follow the instructions for calibrating a single channel. If your instrument is a multi-channel instrument that includes an infrared hydrocarbon channel, RKI Instruments, Inc. recommends using the auto calibration method for convenience. The calibration instructions below show a 5 channel instrument which has the four standard channels, LEL/oxygen/H<sub>2</sub>S/CO, and an infrared hydrocarbon channel.

The standard factory calibration for the autoranging infrared hydrocarbon sensor is to 50 %LEL isobutane. If you need maximum accuracy in the %vol range, the sensor may be

calibrated to 10 %vol isobutane.

To use the auto calibration method to calibrate a multi-channel instrument that includes an infrared hydrocarbon channel, do the following:

1. See “Calibration Supplies and Equipment” on page 55 for a description of the necessary calibration supplies. In addition to an appropriate multi-gas cylinder that is used to calibrate any active standard channels, you will also need a cylinder to calibrate the infrared hydrocarbon channel. See Table 33 on page 236 for available cylinders. Make sure your calibration cylinder is appropriate for the infrared hydrocarbon detection range.
2. Find a fresh-air environment. This is an environment free of toxic or combustible gases and of normal oxygen content (20.9%).
3. While in Measuring Mode, press and hold the RANGE ▼ SHIFT button, then press the DISPLAY ADJUST NO button and release both buttons.
4. If the unit prompts you for the password, enter it by using the AIR ▲ YES and RANGE ▼ SHIFT buttons to select each password number and then pressing and releasing POWER ENTER RESET to enter the number and move on to the next one.
5. The Calibration Mode Screen displays with the cursor next to **AUTO CALIBRATION**.

```
CALIBRATION MODE
> AUTO CALIBRATION
  SINGLE CALIBRATION
  PERFORM AIR ADJUST
  NORMAL OPERATION
```

6. Move the cursor to the **PERFORM AIR ADJUST** menu item by using the RANGE ▼ SHIFT button.

```
CALIBRATION MODE
  AUTO CALIBRATION
  SINGLE CALIBRATION
  > PERFORM AIR ADJUST
  NORMAL OPERATION
```

7. Press and release the POWER ENTER RESET button. The following screen appears.

```
PERFORM
AIR ADJUST?
```

8. Press and release the AIR ▲ YES button to continue. If you do not want to continue, press the DISPLAY ADJUST NO button and the unit will return to the Calibration Mode Screen.

9. The EAGLE 2 will indicate that it is adjusting the zero reading for a few seconds, then indicate that the operation is complete before returning to the Calibration Mode Screen.

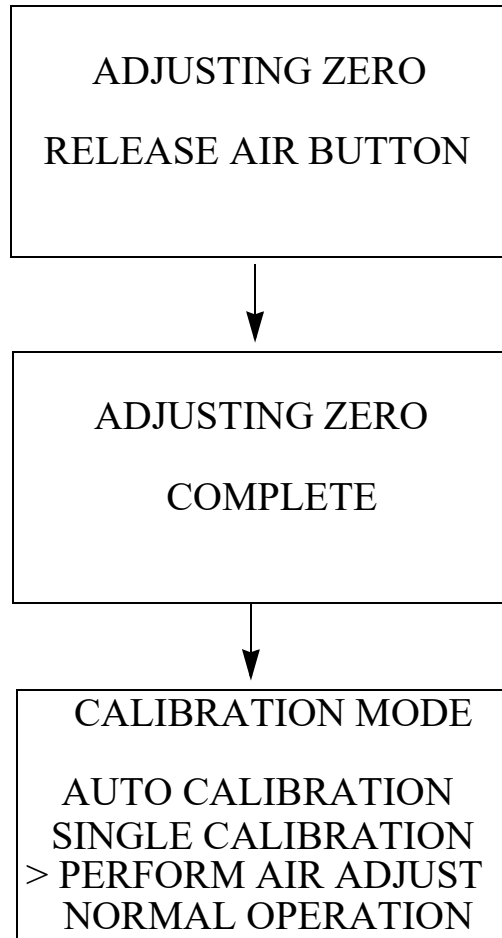

10. Install the demand flow regulator onto the multi-gas calibration cylinder.
11. Connect the sample tubing to the demand flow regulator.
12. Install the probe on the EAGLE 2 inlet fitting. Make sure the probe is complete with internal O-ring and membrane and that the two halves of the probe are tightened firmly together to avoid leaks that can affect the calibration. See Figure 21, “Replacing the Particle Filter and Hydrophobic Filter Disk” on page 72 for an illustration of the internal parts of the probe.
13. Move the cursor next to the **AUTO CALIBRATION** menu item by using the AIR ▲ YES button.

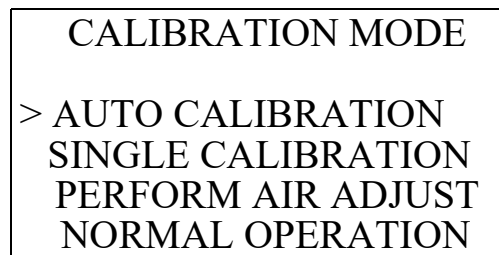

14. Press and release the POWER ENTER RESET button to display the Calibration Gas Values Screen.

CAL GAS VALUES		
CH4	50	%LEL
OXY	12.0	vol%
H2S	25.0	ppm
CO	50	ppm
ENTER TO BEGIN CAL		

The gas concentrations displayed in the Calibration Gas Values Screen must match the gas concentrations listed on the 4-gas calibration cylinder.

If *all* concentrations match, go to Step 25.

If *one or more* concentrations *do not* match, continue with Step 15.

If you do not want to continue with the calibration, press and release the DISPLAY ADJUST NO button to return to the Calibration Mode Screen.

**NOTE:** The RKI 4-gas cylinder typically contains 12% O<sub>2</sub> by volume. When using the auto calibration method, be sure to set the “OXY” auto calibration value to agree with the concentration listed on the cylinder’s label, not zero.

15. To adjust the values on the screen, press and hold the RANGE ▼ SHIFT button, then press the DISPLAY ADJUST NO button and release both. The following screen appears with the cursor next to CH4.

ADJUST AUTO		
CALIBRATION VALUES		
> CH4	50	%LEL
OXY	12.0	vol%
H2S	25.0	ppm
CO	50	ppm ▼

16. Place the cursor next to the channel whose gas value you want to change using the AIR ▲ YES and RANGE ▼ SHIFT buttons.
17. Press and release the POWER ENTER RESET button to select the channel. The calibration gas value begins to flash.
18. Use the AIR ▲ YES and RANGE ▼ SHIFT buttons to adjust the calibration gas setting to the desired value.

**NOTE:** The calibration gas value cannot be set lower than the low alarm setting. If the calibration gas value listed on the calibration cylinder is lower than the current low alarm setting, enter Setup Mode and change the low alarm setting. See “Updating the Alarm Point Settings” on page 106 for instructions. If you need to change the alarm point setting only to perform a calibration, make sure that you change the alarm point setting back to its original value once the calibration has been performed.

19. Press and release the POWER ENTER RESET button to save the change. The calibration gas value stops flashing.
20. Repeat Step 16 through Step 19 for any other channels that need to be changed.

21. When you are done adjusting the calibration gas values, move the cursor down past the bottom of the screen next to **END**.

```
ADJUST AUTO
CALIBRATION VALUES
> END ▲
```

22. Press and release the POWER ENTER RESET button. The following screen appears.

```
DO YOU WANT TO
STORE NEW VALUE(S)
IN MEMORY FOR
FUTURE CALIBRATIONS?

PRESS YES OR NO
```

23. If you select YES by pressing and releasing the AIR ▲ YES button, the changes that you made will be saved in the EAGLE 2's memory as the new auto calibration gas values.

If you select NO by pressing and releasing the DISPLAY ADJUST NO button, the changes you made will be used for any calibrations performed during the current operating session only. The EAGLE 2 will delete the changes when the unit is turned off and will load the previous set of auto calibration values when it is turned on again.

24. When you make your selection and press the desired button, the unit returns to the Calibration Gas Values Screen.

```
CAL GAS VALUES
CH4 50 %LEL
OXY 12.0 vol%
H2S 25.0 ppm
CO 50 ppm
ENTER TO BEGIN CAL
```

25. Press and release the POWER ENTER RESET button to proceed to the Calibration In Process Screen with **CAL IN PROCESS** flashing.

```
CAL IN PROCESS
CH4 0 %LEL
OXY 20.9 vol%
H2S 0.0 ppm
CO 0 ppm
ENTER WHEN DONE
```

If you do not want to proceed with the calibration, press and release the DISPLAY ADJUST NO button to return to the Cal Gas Values Screen.

If you do want to continue with the calibration, proceed to the next step.

26. Connect the tubing from the demand flow regulator to the rigid tube on the probe. Allow the EAGLE 2 to draw gas for one minute.
27. Press and release the POWER ENTER RESET button to set the span adjustment for each channel to the programmed values.
28. If all channels passed calibration, the following screen sequence occurs.

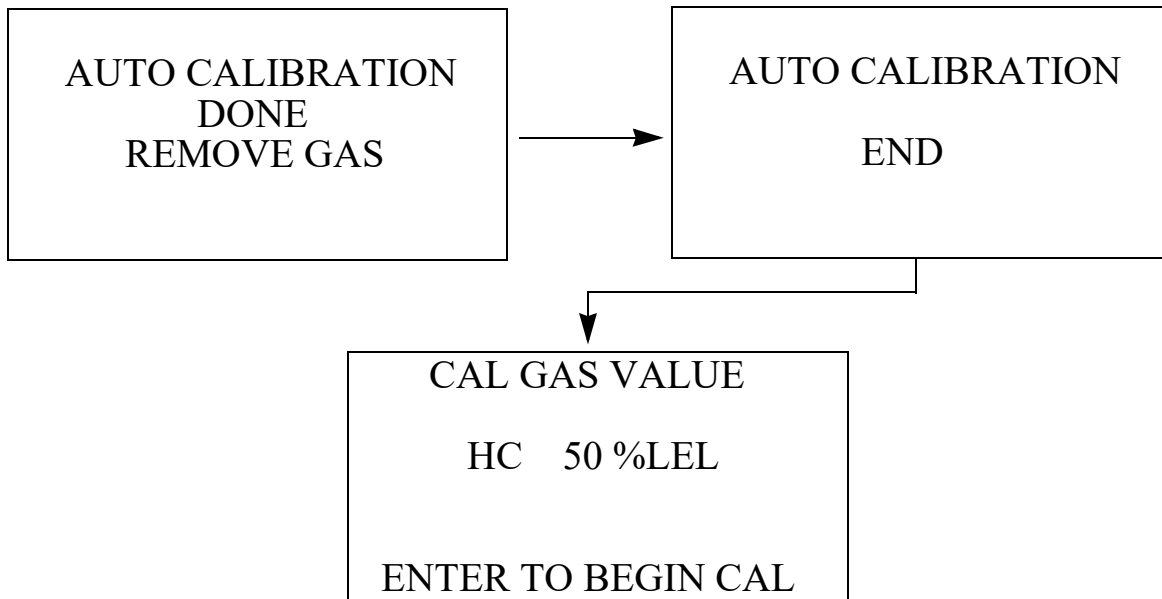

If any of the sensors cannot be adjusted to the proper value, a screen displays that indicates a calibration failure and lists the sensor(s) that failed to calibrate. In the example below, the oxygen and H<sub>2</sub>S channels failed calibration. The other sensors calibrated normally.

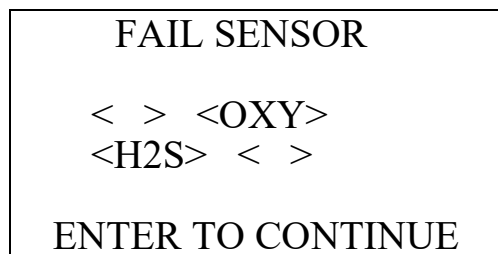

The buzzer and alarm LEDs activate in a double pulsing pattern. Press and release the POWER ENTER RESET button to reset the alarm and continue to the Calibration Value Screen for the infrared hydrocarbon channel. After calibrating the infrared hydrocarbon channel by following the instructions below, attempt to calibrate the standard channels again. If the failure continues, investigate the cause. See “Troubleshooting” on page 67.

29. Remove the tubing from the rigid tube on the probe.
30. Unscrew the 4-gas cylinder from the demand flow regulator.

31. If you want to change the infrared hydrocarbon channel's calibration gas value, follow Step 15 - Step 24 above beginning with the infrared hydrocarbon Calibration Gas Value Screen below instead of the standard channel Calibration Gas Value Screen.

CAL GAS VALUE  
 HC 50 %LEL  
 ENTER TO BEGIN CAL

32. With the infrared hydrocarbon Calibration Gas Value Screen displayed, press and release the POWER ENTER RESET button to proceed to the Calibration In Process Screen for the infrared hydrocarbon channel with **CAL IN PROCESS** flashing.

CAL IN PROCESS  
 HC 0 %LEL  
 ENTER WHEN DONE

If you do not want to proceed with the calibration, press and release the DISPLAY ADJUST NO button to return to the infrared hydrocarbon Cal Gas Values Screen.

If you do want to continue with the calibration, proceed to the next step.

33. Screw the infrared hydrocarbon calibration cylinder onto the demand flow regulator.  
 34. Connect the tubing from the regulator to the rigid tube on the probe. Allow the EAGLE 2 to draw gas for one minute.  
 35. Press and release the POWER ENTER RESET button to set the span adjustment for the infrared hydrocarbon channel to the programmed value.  
 36. If the infrared hydrocarbon channel passed calibration, the following screen sequence occurs.

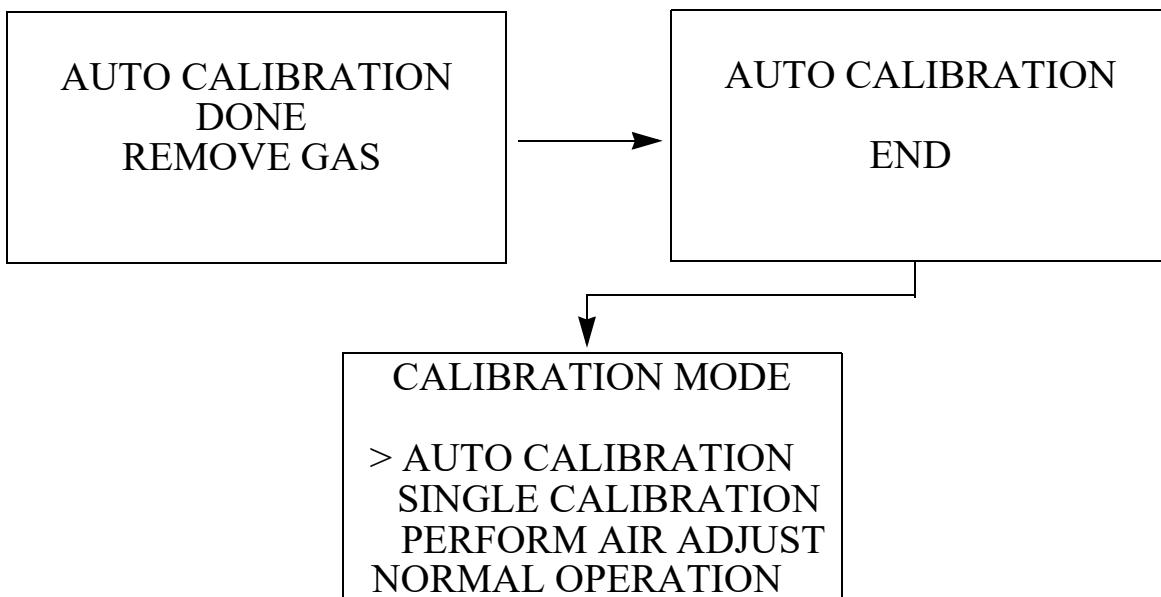

If the infrared hydrocarbon channel cannot be adjusted to the proper value, a screen displays that indicates a calibration failure and indicates that the infrared hydrocarbon sensor failed to calibrate.

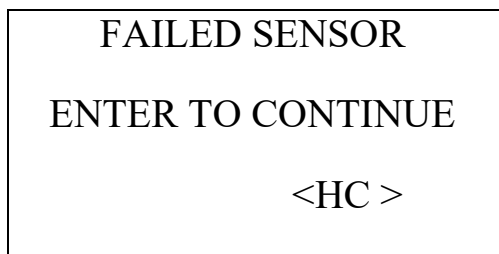

The buzzer and alarm LEDs activate in a double pulsing pattern. Press and release the POWER ENTER RESET button to reset the alarm and continue to the Calibration Mode Screen. Attempt to calibrate the infrared hydrocarbon channel again. If the failure continues, investigate the cause. See “Troubleshooting” on page 67.

37. Disconnect the tubing from the probe.
38. Unscrew the demand flow regulator from the calibration cylinder.
39. Use the RANGE ▼ SHIFT button to place the cursor next to the **NORMAL OPERATION** menu option, then press and release the POWER ENTER RESET button to return to Measuring Mode.

---

## Maintenance

This section includes a procedure to replace an infrared hydrocarbon sensor.

### Replacing the IR Hydrocarbon Sensor

1. Verify that the EAGLE 2 is off.
2. Place the EAGLE 2 upside down on a flat surface or hold it upside down.
3. Unscrew the three case screws until they disengage from the top case. They are captive screws so they will not fall off of the bottom case.
4. Turn the EAGLE 2 right side up and carefully lift the top case away from the bottom case. Be careful not to lift it so far that it pulls on the main PCB with the cable that connects the top case to the main PCB.
5. Lay the top case down next to the bottom case to allow access to the flow system.
6. Locate the infrared hydrocarbon sensor. It has a twelve wire cable with a connector that mates to an infrared sub PCB that is installed on the main PCB and is normally located next to the pump. Figure 43 on page 227 shows an infrared hydrocarbon sensor in a typical location.
7. Unscrew and remove the two screws that hold down the infrared hydrocarbon sensor bracket.
8. Grasp the sensor firmly and pull it out of the infrared hydrocarbon flow chamber. Rock it back and forth gently if necessary to pull it out. Take care not to pull the cable from the sub PCB.
9. Rotate the locking lever counterclockwise on the cable connector that mates to the infrared hydrocarbon sensor to unlock it.
10. Unplug the old infrared hydrocarbon sensor from the cable.

11. Connect the new infrared hydrocarbon sensor to the sensor cable and rotate the locking lever clockwise to lock the connector.
12. Insert the sensor into the infrared hydrocarbon flow chamber and push it in until it bottoms out.
13. Line up the holes in the infrared hydrocarbon sensor bracket with the two standoffs on the infrared hydrocarbon chamber.
14. Install the two sensor bracket screws.
15. Confirm that the main PCB is seated in its slots and that its bottom edge is resting on the bottom of the bottom case. If the main PCB is not seated properly, it may be damaged when the top case is re-installed.
16. Make sure that the top case gasket is fully seated in its groove and carefully put the top case back on the bottom case. If you have any difficulty mating the top and bottom cases, inspect the placement of the main PCB and the placement of the top case gasket.
17. Turn the EAGLE 2 upside down and tighten the three case screws to secure the top case to the bottom case.
18. Calibrate the infrared hydrocarbon channel as described in “Infrared Hydrocarbon Calibration” on page 228.

---

## Parts List

**Table 33: Infrared HC EAGLE 2 Parts List**

<b>Part Number</b>	<b>Description</b>
47-5051RK	Infrared HC sensor cable
DEM-3313-2	Infrared HC sensor, 0-100 %LEL/2.0-30.0 %vol autoranging
81-0018RK-01	Calibration cylinder, 50 %LEL isobutane in air, 34 liter steel
81-0018RK-03	Calibration cylinder, 50 %LEL isobutane in air, 103 liter steel
81-0019RK	Calibration cylinder, 10 %volume isobutane in nitrogen, 17 liter steel

# Appendix J: Methane Elimination Mode

---

## Overview

For applications where methane is an interfering gas, you can set the EAGLE 2 to eliminate most response to methane using methane elimination mode.

**CAUTION:** *The EAGLE 2 catalytic combustible sensor experiences a significant gas response drop when it is changed from full response mode to methane elimination mode. The EAGLE 2 must be calibrated in both full response mode and in methane elimination mode to account for this. See “Calibration” on page 240 for further instructions.*

---

## Monitoring in Methane Elimination Mode

To monitor an area using methane elimination mode, do the following:

1. Turn on the EAGLE 2 as described in “Start Up” on page 27.
2. Make sure that the EAGLE 2 catalytic combustible channel is set to monitor a gas in which methane elimination is an option. For a list of these gases and a procedure to select one, see “Configuring the Combustible Gas” on page 101. A common target gas is hexane. Once a gas that allows for methane elimination is selected for the catalytic combustible channel, the methane elimination mode screen becomes part of Display Mode.
3. Use the DISPLAY button to enter Display Mode and to scroll through the screens until you reach the Methane Elimination Mode screen. The current setting is displayed.

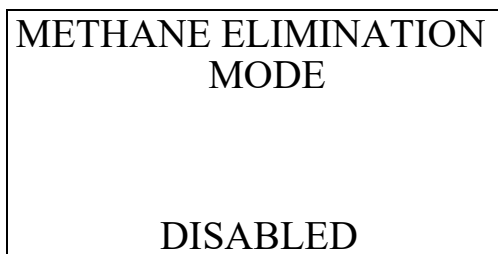

4. Press and release the AIR ▲ YES or RANGE ▼ SHIFT button to toggle the setting to ENABLED.
5. Press and release the POWER ENTER RESET button. The unit will save the setting and proceed to the next menu item.
6. You will note that if methane elimination is enabled, the Catalytic Sensor Relative Response screen no longer appears even if the relative response feature in Setup Mode is turned on. While methane elimination is enabled, the Catalytic Sensor Relative Response screen will not appear in Display Mode even if the relative response feature in Setup Mode is enabled.

- Continue to press the DISPLAY button until the Measuring Mode screen appears.

HEX	0%LEL	ME
OXY	20.9vol%	
H2S	0.0ppm	
CO	0ppm	

When the instrument is reading in methane elimination, an ME appears in line with the catalytic combustible channel reading.

- Allow 2 minutes for the combustible sensor to stabilize.
- Perform a demand zero. See “Performing a Demand Zero” on page 31 for instructions.
- Monitor for the target gas.
- If you wish to monitor for any other gas while in methane elimination mode, a conversion factor must be taken into consideration. With the EAGLE 2 calibrated to hexane, use Table 34 below to determine the concentrations of other target gases. Multiply the display reading by the factor in the appropriate column to determine the actual reading for that gas. For example, if you are using the EAGLE 2 in methane elimination mode to detect isobutane and the display reads 10% LEL, the actual isobutane reading is  $10\% \times 0.59 = 5.9\%$  LEL isobutane.

**Table 34: Methane Elimination Mode Conversion Factors (Hexane Calibration)**

Target Gas	LEL Factor	PPM Factor	Target Gas	LEL Factor	PPM Factor
Acetone	0.58	1.32	Isobutane	0.59	0.97
Benzene	1.01	1.10	Isopropanol	0.85	1.55
Butyl Acrylate	*	1.52	Methane	No response	No response
Butyl Acetate	1.34	1.58	Methanol	0.58	3.16
2-Butyl Alcohol	0.84	1.30	Methyl Acetate	0.55	1.55
1-Butyl Alcohol	1.71	2.18	Methyl Acrylate	0.83	2.11
Cyclohexane	1.06	1.25	Methyl Ethyl Keytone	1.04	1.32
Cumene	1.74	1.42	Methyl Isobutyl Keytone	1.30	1.42
Ethylene Dichloride	2.04	11.50	Mixed Xylenes	1.36	1.36
Ethyl Alcohol	0.57	1.71	Nonane	1.66	1.21
Ethyl Chloride	0.59	2.04	Pentane	0.54	0.74
Ethyl Acrylate	1.32	1.68	Propane	Low response	Low response

Target Gas	LEL Factor	PPM Factor	Target Gas	LEL Factor	PPM Factor
Hexane	1.00	1.00	Styrene	1.74	1.42
Hydrogen	0.48	1.75	Toluene	1.25	1.25
			Vinyl Acetate Monomer	0.92	2.17
* Vapor pressure too low for significant LEL reading					

**WARNING:** *The EAGLE 2's alarms are initiated by the display reading, not the factored reading. If you are monitoring for isobutane as in the above example and the low alarm is set for 10% LEL, the EAGLE 2 will initiate a low alarm at 5.9% LEL isobutane (display reading of 10% LEL).*

12. To return to full response mode, return to the Methane Elimination Mode screen in Display Mode and press and release the AIR ▲ YES or RANGE ▼ SHIFT button to toggle the setting to DISABLED.
13. Press and release the POWER ENTER RESET button. The unit will save the setting and proceed to the next menu item.
14. Continue to press the DISPLAY button until the Measuring Mode screen appears.

HEX	0%LEL
OXY	20.9vol%
H2S	0.0ppm
CO	0ppm

The ME is no longer next to the catalytic combustible channel reading indicating that the unit is measuring in full response mode.

15. Allow 2 minutes for the combustible sensor to stabilize before monitoring the target gas.
16. Perform a demand zero. See “Performing a Demand Zero” on page 31 for instructions.
17. Monitor for the target gas.

**NOTE:** The EAGLE 2 retains the methane elimination mode setting when it is turned off. The methane elimination mode setting, ENABLED or DISABLED, will remain in effect until it is changed in Display Mode. So if methane elimination mode is enabled when you turn off the EAGLE 2, it will remain enabled when you turn the EAGLE 2 on again.

---

## Calibration

The EAGLE 2 stores calibration data for the instrument both in methane elimination mode and in full response mode. When using the instrument for applications where methane elimination mode is used, it is most common to calibrate to hexane. If you are planning to use the EAGLE 2 in methane elimination mode, RKI Instruments, Inc. recommends that you setup and calibrate the instrument to hexane in both full response and methane elimination mode unless your application requires a different setup and calibration. See “Configuring the Combustible Gas” on page 101 for instructions to setup the catalytic combustible channel gas.

**CAUTION:** *The EAGLE 2 catalytic combustible sensor experiences a significant gas response drop when it is changed from full response mode to methane elimination mode. The EAGLE 2 must be calibrated in both full response mode and in methane elimination mode to account for this.*

To properly calibrate the instrument, do the following:

1. With the EAGLE 2 catalytic combustible channel set up for hexane, perform a demand zero and a calibration while in full response. See “Chapter 4: Calibration Mode” on page 54 for instructions.
2. Enable methane elimination in Display Mode.
3. Allow the unit to stabilize for 2 minutes.
4. Perform a demand zero and a calibration while in methane elimination mode. See “Chapter 4: Calibration Mode” on page 54 for instructions.

# Appendix K: Using the EAGLE 2 in Bar Hole Mode

---

## Overview

This chapter explains how to operate the EAGLE 2 in Bar Hole Mode. Bar Hole Mode is used to perform consistent checks of bar holes when tracking down underground gas leaks. When the EAGLE 2 is in Bar Hole Mode, only the combustible and oxygen sensors are displayed.

If an EAGLE 2 is intended for bar hole testing, it is shipped with Bar Hole Mode or both Bar Hole Mode and Leak Check Mode enabled so that the operator must choose which operational mode to use when the unit is turned on (see “Updating LC/BH Mode Setting” on page 114).

---

## Start Up, Bar Hole Mode

This section explains how to start up the EAGLE 2 in Bar Hole Mode and get it ready for operation.

### Turning On the EAGLE 2, Bar Hole Mode

**WARNING:** *If one or more sensors other than a catalytic LEL, TC, or oxygen sensor is installed, these sensors will not be active while the EAGLE 2 is in Bar Hole Mode.*

**WARNING:** *Gas alarms are not active when the EAGLE 2 is in Bar Hole Mode.*

The following description of the EAGLE 2 start up sequence assumes that the following menu items in Setup Mode are turned on: CAL REMINDER and USER/STATION ID. If either of these items is turned off, then the corresponding screen will not appear.

**NOTE:** In order for **BAR HOLE MODE** to appear as a selection in the Mode Select Screen in Step 3 below, the EAGLE 2 must have both a catalytic LEL sensor and a TC sensor installed. In addition, both the catalytic LEL and TC channels must be configured for methane, CH<sub>4</sub>, in the CONFIGURE GASES menu item in Setup Mode. If an EAGLE 2 has only the catalytic LEL sensor installed or if the TC channel is configured for a gas other than CH<sub>4</sub>, then **BAR HOLE MODE** will not appear as a choice as shown in Step 3 below and **NORMAL MODE** and **LEAK CHECK MODE** will be the only choices displayed. In this case, see “Turning On the EAGLE 2” on page 27 or “Turning On the EAGLE 2, Leak Check Mode” on page 249.

1. Connect the sample hose to the EAGLE 2’s quick connect inlet fitting.
2. Connect the bar hole probe to the sample hose’s quick connect fitting.
3. Press and briefly hold down the POWER ENTER RESET button. Release the button when you hear a beep.

4. The LCD will show the following screen for about ten seconds.



5. The Battery Voltage Screen appears for a few seconds.

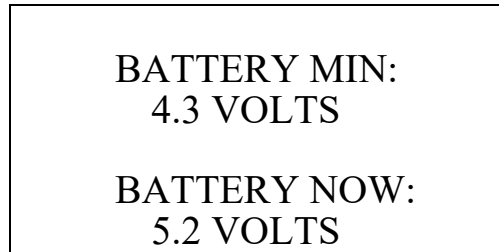

6. The Mode Select Screen displays.

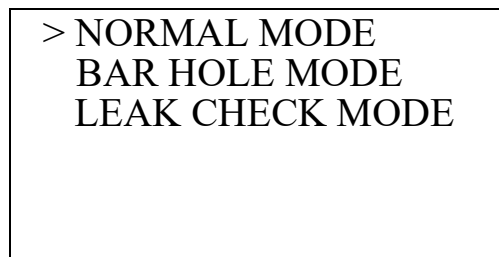

7. The cursor will flash in front of **NORMAL MODE**. Use the RANGE ▼ SHIFT button to move the cursor next to **BAR HOLE MODE**.
8. With Bar Hole Mode selected, press and release the POWER ENTER RESET button to begin the Bar Hole Mode startup sequence.

**NOTE:** If no button is pressed for 20 seconds, the unit will proceed into whichever mode has the cursor in front of it.

9. The Active Gases Screen appears for a few seconds indicating which channels are active and their target gas.

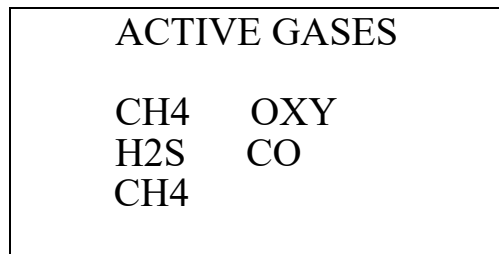

10. The gas alarm setpoints are displayed by three screens in sequence: the Low Alarm Screen, High Alarm Screen, and STEL/TWA Alarm Screen. Each screen remains on the LCD for three seconds.

```

A CH4 10 %LEL
L L OXY 19.5 vol%
O A H2S 10.0 ppm
WR CO 25 ppm
    CH4M 10 vol%
    S
  
```

```

A CH4 50 %LEL
HL OXY 23.5 vol%
I A H2S 30.0 ppm
GR CO 50 ppm
HM CH4 50 vol%
S
  
```

```

ALARMS STEL & TWA
H2S(ppm) 15.0 10.0
CO (ppm) 200 25
CH4(vol%) OFF OFF
  
```

11. After the alarm screens, if CAL REMINDER is turned on, the screen that appears next depends on how CAL PAST DUE ACT is set in the Setup Mode Menu (see “Updating the Calibration Past Due Action Setting” on page 113).
- If the unit is due for calibration and CAL PAST DUE ACT is set to CONFIRM TO CAL, then the following screen displays and the buzzer sounds in a double pulsing pattern.

```

CALIBRATION DATE
IS PAST DUE

PERFORM
CALIBRATION?
  
```

To perform a calibration, press and release the AIR ▲ YES button. The EAGLE 2 will enter Calibration Mode and the LCD will show the Calibration Mode main menu. See “Chapter 4: Calibration Mode” on page 54 for instructions to calibrate the EAGLE 2. When you are done with the calibration and exit Calibration Mode, the unit will begin the startup sequence. If the calibration was successful, the screen above will not appear again until the unit is due for calibration. If the calibration was not successful, the screen above will again appear in the startup sequence.

To continue without performing a calibration, press and release the DISPLAY ADJUST NO button.

- If the unit is due for calibration and CAL PAST DUE ACT is set to MUST CALIBRATE, then the following screen displays and the buzzer sounds in a double pulsing pattern.

CALIBRATION DATE  
IS PAST DUE  
  
ENTER TO PERFORM  
CALIBRATION

The EAGLE 2 cannot be used until a successful calibration has been performed. Press and release the ENTER button to enter Calibration Mode. See “Chapter 4: Calibration Mode” on page 54 for instructions to calibrate the EAGLE 2. When you are done with the calibration and exit Calibration Mode, the unit will begin the startup sequence. If the calibration was successful, the screen above will not appear again until the unit is due for calibration. If the calibration was not successful, the screen above will again appear in the startup sequence.

- If the unit is due for calibration and CAL PAST DUE ACT is set to NOTIFICATION ONLY, then the following alert screen displays and the buzzer sounds in a double pulsing pattern.

CALIBRATION DATE  
  
IS PAST DUE

Press and release the POWER ENTER RESET button to acknowledge the alert and continue with the startup sequence.

12. The Date/Time Screen appears for a few seconds.

9/12/2008  
  
15:00:00

13. If USER/STATION ID is turned on (see “Turning the User/Station ID Function On or Off” on page 109), the ID Screen appears for a few seconds.

USER ID  
MIKE  
STATION ID  
PUMP 1  
SERIAL NUMBER  
E2A515

If USER/STATION ID is turned off, only the serial number is shown.

14. If the EAGLE 2 experiences a sensor failure during start up, a screen indicating which sensor failed appears and the buzzer sounds a pulsing tone twice per second. In the example below, the TC %volume CH<sub>4</sub> sensor has failed.

FAILED SENSOR(S)

< > < >

< > < >

<CH4>

ENTER TO CONTINUE

If one of the combustible sensors, LEL or TC, fails, it is not possible to enter Bar Hole Mode. Press and release the POWER ENTER RESET button to acknowledge the failure and return to the Mode Select Screen. Replace the failed sensor as soon as possible.

If the oxygen sensor fails, press and release the POWER ENTER RESET button to acknowledge the failure and continue to Bar Hole Mode. The gas reading for the oxygen sensor will be replaced by “XXX”. Replace the failed sensor as soon as possible.

If any other sensor that is installed fails, press and release the POWER ENTER RESET button to acknowledge the failure and continue to Bar Hole Mode. Replace the failed sensor(s) as soon as possible for use in Normal Mode.

15. The EAGLE 2 is now operating in Bar Hole Mode. The pump is off and the following screen appears.

BAR HOLE MODE

CH4            0 %LEL

OXY            20.9 vol%

ENTER: MEASURE

ADJUST: PURGE

Only the methane and oxygen channels are displayed.

**NOTE:** The units for the methane channel can be changed using the RANGE ▼ SHIFT button. Press and release the RANGE ▼ SHIFT button until the desired units, ppm, LEL, or vol%, are displayed.

**NOTE:** If measuring the combustible gas in ppm units, for maximum sensor stability, allow 3-5 minutes for the sensor to warm up. The small increment size in the lower range of a ppm measurement can cause instability if the unit is not properly warmed up.

### Performing a Demand Zero, Bar Hole Mode

Before using the EAGLE 2, it is recommended to set the fresh air readings for the target gases by performing a demand zero. This will set the CH<sub>4</sub> channel to zero and the OXY channel to 20.9%.

1. Find a fresh-air environment. This is an environment free of toxic or combustible gases and of normal oxygen content (20.9%).

2. Turn on the unit as described above in “Turning On the EAGLE 2, Bar Hole Mode” on page 241.
3. Press and hold the AIR ▲ YES button. The display will indicate that a demand zero is taking place and prompt you to hold the AIR ▲ YES button.
4. Continue to hold the AIR ▲ YES button until the display prompts you to release it. The EAGLE 2 will set the fresh air reading for the CH<sub>4</sub> and oxygen channels. Start up is complete and the unit is now ready for bar hole testing.

---

## Bar Hole Testing

In Bar Hole Mode, the you can initiate sampling for a fixed time period to monitor for methane and oxygen in a bar hole. The factory set time is 30 seconds. At the end of the sample period, the pump will shut off and the peak methane and minimum oxygen levels monitored during the sample period will be displayed. Bar Hole Mode also allows you to initiate an air purge cycle to purge gas from the EAGLE 2 after a sample is taken. See “Setting the Bar Hole Measurement Time” on page 115 to change the bar hole sample time.

In a low-light environment, press and release the RANGE ▼ SHIFT button to turn on the display backlight. Although the backlight will turn on when any button is pressed, other buttons may initiate an undesired operation sequence. See “Updating the Backlight Delay Setting” on page 110 to program backlight duration. If CONFIRMATION ALERT is turned on in the Setup Mode menu, the EAGLE 2 will alert you based on the setting you choose once every 15 minutes to confirm that it’s operating.

### Performing a Bar Hole Test

1. Start up the EAGLE 2 as described in “Start Up, Bar Hole Mode” on page 241.
2. Take the EAGLE 2 to the bar hole that will be tested.
3. Insert the probe into the bar hole and press and release the ENTER button. The pump will turn on, the display will indicate “MEASURING...” below the oxygen reading, and the sample period will begin with the sample period counting down in seconds in the lower right corner of the display. The CH<sub>4</sub> channel will be displayed in vol%.

BAR HOLE MODE	
CH <sub>4</sub>	0 vol%
OXY	20.9 vol%
MEASURING...	
30 SEC	

4. After 15 seconds of sampling, if the CH<sub>4</sub> reading is less than 5 vol%, the CH<sub>4</sub> channel will automatically begin displaying in the units you selected earlier. If you selected the methane channel to be displayed in vol%, then after 15 seconds, the reading will remain in vol%.

- At the end of the sample period, the pump will shut off and the audible alarm will sound, then the peak methane reading and the minimum oxygen reading for the sample period will be displayed.

BAR HOLE MODE		
P		
E	CH4	0 vol%
A	OXY	20.9 vol%
K	ENTER: MEASURE	
	ADJUST: PURGE	

- If a high concentration of methane is encountered, a fresh air purge can be performed to purge the hose, probe and EAGLE 2 of gas before the next bar hole test. To perform a purge, do the following:
  - Remove the probe from the barhole so the instrument will draw fresh air.
  - Press and release the DISPLAY ADJUST NO button. The display will now indicate "FRESH AIR PURGE . . ." below the oxygen reading and the purge time will begin counting down from 30 seconds in the lower right corner of the display.

BAR HOLE MODE		
	CH4	0 vol%
	OXY	20.9 vol%
	FRESH AIR PURGE...	
		30 SEC

- After 15 seconds of sampling, if the CH<sub>4</sub> reading is less than 5 vol%, the CH<sub>4</sub> channel will automatically begin displaying in the units you selected earlier. Since performing a fresh air purge draws fresh air, the display units should always switch to the previously selected units. If you selected the methane channel to be displayed in vol%, then after 15 seconds, the reading will remain in vol%.
- When the purge is complete, the screen will return to the initial Bar Hole Mode screen.

BAR HOLE MODE		
	CH4	0 vol%
	OXY	20.9 vol%
	ENTER: MEASURE	
	ADJUST: PURGE	

- If other bar holes will be tested, proceed to the next bar hole and repeat Step 3 - Step 6.
- To cancel a bar hole measurement or fresh air purge that is in progress, press and release the DISPLAY ADJUST NO button.
- To exit Bar Hole Mode and return to the Mode Select Screen at any time, press and hold the RANGE ▼ SHIFT button for 5 seconds.

## Turning Off the EAGLE 2, Bar Hole Mode

1. Press and hold the POWER ENTER button.
2. The unit will initiate a bar hole measurement. Keep holding the POWER ENTER button. The buzzer will sound and the LCD back light will flash for about five seconds.
3. Release the button when GOODBYE appears on the display. When GOODBYE disappears and the backlight turns off, the unit is off.

# Appendix L: Using the EAGLE 2 in Leak Check Mode

---

## Overview

This chapter explains how to operate the EAGLE 2 in Leak Check Mode. Leak Check Mode is used to pinpoint small leaks of combustible gas from valves, flanges, connections, and other potential leak points. When the EAGLE 2 is in Leak Check Mode, only the catalytic combustible sensor is active.

If an EAGLE 2 is intended for tracking down leaks, it is shipped with Leak Check Mode or both Leak Check Mode and Bar Hole Mode enabled so that the operator must choose which operational mode to use when the unit is turned on (see “Updating LC/BH Mode Setting” on page 114).

---

## Start Up, Leak Check Mode

This section explains how to start up the EAGLE 2 in Leak Check Mode and get it ready for operation.

### Turning On the EAGLE 2, Leak Check Mode

**CAUTION:** *If one or more sensors other than a catalytic combustible sensor is installed, these sensors will not be active while the EAGLE 2 is in Leak Check Mode.*

The following description of the EAGLE 2 start up sequence assumes that the following menu items in Setup Mode are turned on: CAL REMINDER and USER/STATION ID. If either of these items is turned off, then the corresponding screen will not appear.

1. Connect the standard probe to the EAGLE 2’s quick connect inlet fitting.

**NOTE:** Use the standard probe, not the bar hole probe, when using the EAGLE 2 in Leak Check Mode.

2. If a sample hose is used, connect the sample hose to the EAGLE 2’s quick connect inlet fitting and connect the probe to the sample hose’s quick connect fitting.
3. Press and briefly hold down the POWER ENTER RESET button. Release the button when you hear a beep.
4. The LCD will show the following screen for about ten seconds.



5. The Battery Voltage Screen appears for a few seconds.

BATTERY MIN:  
4.3 VOLTS  
  
BATTERY NOW:  
5.2 VOLTS

6. The Mode Select Screen displays.

> NORMAL MODE  
BAR HOLE MODE  
LEAK CHECK MODE

7. The cursor will flash in front of **NORMAL MODE**. Use the RANGE ▼ SHIFT button to move the cursor next to **LEAK CHECK MODE**.
8. With Leak Check Mode selected, press and release the POWER ENTER RESET button to begin the Leak Check Mode startup sequence.

**NOTE:** If no button is pressed for 20 seconds, the unit will proceed into whichever mode has the cursor in front of it.

9. The Active Gases Screen appears for a few seconds indicating which channels are active and their target gas.

ACTIVE GASES  
  
CH4 OXY  
H2S CO  
CH4

10. The gas alarm setpoints are displayed by three screens in sequence: the Low Alarm Screen, High Alarm Screen, and STEL/TWA Alarm Screen. Each screen remains on the LCD for three seconds.

A	CH4	10 %LEL
L	OXY	19.5 vol%
O	A	H2S 10.0 ppm
W	R	CO 25 ppm
M	CH4	10 vol%
S		

A	CH4	50 %LEL
H	L	OXY 23.5 vol%
I	A	H2S 30.0 ppm
G	R	CO 50 ppm
H	M	CH4 50 vol%
S		

ALARMS STEL & TWA		
H2S(ppm)	15.0	10.0
CO (ppm)	200	25
CH4(vol%)	OFF	OFF

11. After the alarm screens, if CAL REMINDER is turned on, the screen that appears next depends on how CAL PAST DUE ACT is set in the Setup Mode Menu (see “Updating the Calibration Past Due Action Setting” on page 113).
- If the unit is due for calibration and CAL PAST DUE ACT is set to CONFIRM TO CAL, then the following screen displays and the buzzer sounds in a double pulsing pattern.

CALIBRATION DATE IS PAST DUE	
PERFORM CALIBRATION?	

To perform a calibration, press and release the AIR ▲ YES button. The EAGLE 2 will enter Calibration Mode and the LCD will show the Calibration Mode main menu. See “Chapter 4: Calibration Mode” on page 54 for instructions to calibrate the EAGLE 2. When you are done with the calibration and exit Calibration Mode, the unit will begin the startup sequence. If the calibration was successful, the screen above will not appear again until the unit is due for calibration. If the calibration was not successful, the screen above will again appear in the startup sequence.

To continue without performing a calibration, press and release the DISPLAY ADJUST NO button.

- If the unit is due for calibration and CAL PAST DUE ACT is set to MUST CALIBRATE, then the following screen displays and the buzzer sounds in a double pulsing pattern.

CALIBRATION DATE  
IS PAST DUE  
  
ENTER TO PERFORM  
CALIBRATION

The EAGLE 2 cannot be used until a successful calibration has been performed. Press and release the ENTER button to enter Calibration Mode. See “Chapter 4: Calibration Mode” on page 54 for instructions to calibrate the EAGLE 2.

**NOTE:** In this situation, even if the password function has been turned on, no password is required to perform a calibration.

When you are done with the calibration and exit Calibration Mode, the unit will begin the startup sequence. If the calibration was successful, the screen above will not appear again until the unit is due for calibration. If the calibration was not successful, the screen above will again appear in the startup sequence.

- If the unit is due for calibration and CAL PAST DUE ACT is set to NOTIFICATION ONLY, then the following alert screen displays and the buzzer sounds in a double pulsing pattern.

CALIBRATION DATE  
IS PAST DUE

Press and release the POWER ENTER RESET button to acknowledge the alert and continue with the startup sequence.

12. The Date/Time Screen appears for a few seconds.

9/12/2008  
  
15:00:00



## Performing a Demand Zero, Leak Check Mode

Before using the EAGLE 2, it is recommended to set the fresh air reading for the target gas by performing a demand zero. This will set the CH<sub>4</sub> channel to zero.

1. Find a fresh-air environment. This is an environment free of toxic or combustible gases and of normal oxygen content (20.9%).
2. Turn on the unit as described above in “Turning On the EAGLE 2, Leak Check Mode”.
3. Press and hold the AIR ▲ YES button. The display prompts you to hold the AIR ▲ YES button.
4. Continue to hold the AIR ▲ YES button until the display prompts you to release it. The EAGLE 2 will set the fresh air reading for the CH<sub>4</sub> channel. Start up is complete and the unit is now ready for monitoring.

---

## Leak Testing

In Leak Check Mode, the EAGLE 2 only displays combustible gas readings. The readings are displayed in both numerical and bar graph form. The bar graph displays readings up to 5,000 ppm while the numerical indicator displays readings up to 50,000 ppm in the following increments:

- 5 ppm increments from 0 ppm to 200 ppm
- 10 ppm increments from 200 ppm to 1,000 ppm
- 50 ppm increments from 1,000 ppm to 10,000 ppm
- 250 ppm increments from 10,000 ppm to 50,000 ppm

As the gas concentration increases from 0 ppm, the alarm LEDs begin to blink in unison with the buzzer’s pulsing. The blinking/pulsing rate increases as the gas reading increases. If desired the buzzer can be turned off in Leak Check Mode.

In a low-light environment, press and release any of the buttons to turn on the display backlight. See “Updating the Backlight Delay Setting” on page 110 to program backlight duration. If CONFIRMATION BEEP is turned on in the Setup Mode menu, the EAGLE 2 beeps once every 15 minutes to confirm that it’s operating.

## Locating a Leak

1. Start up the EAGLE 2 as described above in “Start Up, Leak Check Mode” on page 249.
2. Move the probe tip back and forth along the area where a leak is suspected.
3. Observe the display reading. If the gas level increases, the numerical reading will increase, the bar graph level will increase to the right, and the beeping and buzzer pulsing frequency will increase.
4. Use the increasing and decreasing of the reading to locate the leak point.
5. To exit Leak Check Mode and return to the Mode Select Screen at any time, press and hold the RANGE ▼ SHIFT button for 5 seconds.

## Turning the Buzzer On and Off in Leak Check Mode

The alarm buzzer can be turned off and on when the EAGLE 2 is in Leak Check Mode. This setting only applies to Leak Check Mode and does not affect buzzer operation in Normal or Bar Hole Mode. The buzzer setting is displayed in the lower left corner as **BUZZER ON** when the buzzer is on or **BUZZER OFF** when the buzzer is off. When the EAGLE 2 is turned off or you exit Leak Check Mode, it remembers the buzzer setting. So when the EAGLE 2 is turned on again or you return to Leak Check Mode after operating in Normal Mode or Bar Hole Mode, the buzzer has the same setting it did the last time it was in Leak Check Mode.

To turn the buzzer off or on while in Leak Check Mode, press and release the DISPLAY ADJUST NO button.

## Turning Off the EAGLE 2, Leak Check Mode

1. Press and hold the POWER button.
2. The buzzer will sound and the LCD back light will flash for about five seconds.
3. Release the button when GOODBYE appears on the display. When GOODBYE disappears and the backlight turns off, the unit is off.

# Appendix M: Tank Tester Model

The EAGLE 2 Tank Tester model is intended for checking tanks or vessels that may contain residual hydrocarbon vapors or water or may have been purged of oxygen. It is supplied as an LEL (catalytic) only unit or an LEL (catalytic)/oxygen unit. You can also use this model as a standard EAGLE 2 gas monitor by connecting the standard hose and probe and selection Normal Mode in the Inert Mode Selection Screen.

**Table 35: Alarm Points for Tank Tester Configuration**

	<b>Alarm 1</b>	<b>Alarm 2</b>
<b>LEL</b>	10% LEL 1100 ppm	50% LEL 5500 ppm
<b>Normal Mode Oxygen</b>	Oxy: 19.5% falling	Oxy: 23.5% rising
<b>Inert Mode Oxygen</b>	Oxy: 5.0% rising	Oxy: 10.0% rising

---

## Description

The tank tester model has an additional socket on the front on the housing to accommodate connection of the float probe assembly.

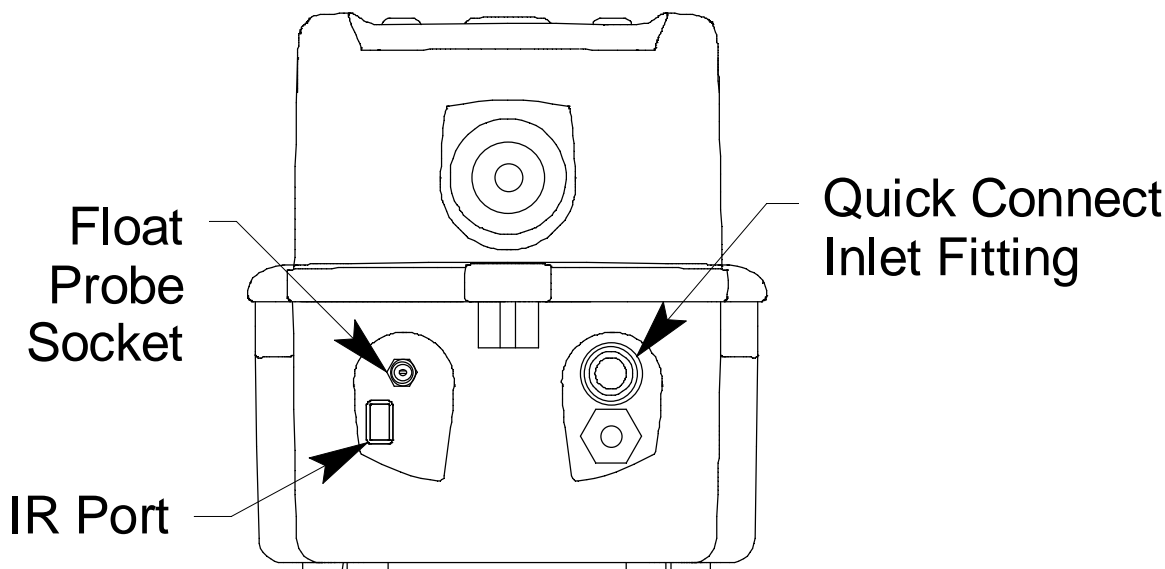
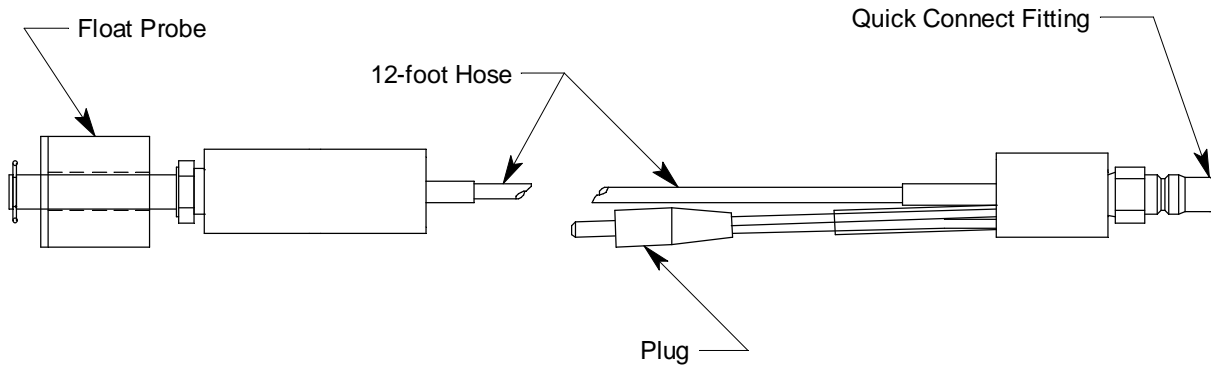

**Figure 44: EAGLE 2 Tank Tester Version**

This model includes the following non-standard components.

## Float Probe Assembly

The float probe assembly helps prevent liquid from being drawn into the EAGLE 2. The float probe assembly is 12-foot long. The hose between both ends of the float probe has an integral cable that connects a switch in the float end to the plug at the other end. This plug connects to the float probe socket that is adjacent to the EAGLE 2's IR port. A quick connect fitting at the same end of the assembly connects to the EAGLE 2's inlet fitting. The float probe switch at the opposite end of the 12-foot hose shuts off the pump if the probe begins to be submerged into a liquid.



**Figure 45: Float Probe Assembly**

To use the float probe assembly:

**CAUTION:** *Drawing water, gasoline, or other liquids into the EAGLE 2 will cause damage.*

1. Attach the quick connect fitting to the EAGLE 2's inlet fitting.
2. Insert the plug into the socket that is adjacent to the IR port.
3. Lower the probe into the tank or vessel. Lower the probe *very slowly*, keeping the float switch vertical, to allow the float switch to activate if necessary.

## Dilution Fitting (1:1)

**CAUTION:** *When measuring oxygen readings, remove the dilution fitting or use your finger to seal the small dilution hole on the side of the dilution fitting.*

The catalytic combustible gas sensor requires oxygen to operate. In environments where there is not enough oxygen to operate the combustible gas sensor, (for example a tank purged with an inerting gas), the 1:1 dilution fitting adds sufficient oxygen by blending ambient air with the incoming sample. The standard dilution fitting dilutes at a ratio of 1:1 (one part air to one part sample). The dilution fitting is not an integral part of the float probe assembly and must be installed on the EAGLE 2 inlet fitting before installing the float probe assembly when measuring gas in an inert atmosphere.

To attach the dilution fitting:

1. Attach the dilution fitting's male quick connect fitting to the EAGLE 2's inlet fitting.
2. Attach the float probe assembly to the opposite end of the dilution fitting.

**NOTE:** When using the dilution fitting, multiply the combustible gas reading (LEL or PPM) by 2 to determine the actual combustible gas concentration. Always remove the dilution fitting or seal the dilution hole with your finger to measure for oxygen.

---

## Start Up and Operation

1. Press and briefly hold down the POWER ENTER RESET button. Release the button when you hear a beep.
2. The LCD will show the following screen for about ten seconds.



3. The Connect Float Probe Screen appears for a few seconds prompting you to confirm that the float probe's quick connect fitting is connected to the EAGLE 2's inlet fitting and that the float probe's plug is connected to the EAGLE 2.



Make sure that the float probe assembly is hanging vertically and that the float device is located at the bottom of the probe.

4. The Battery Voltage Screen appears for a few seconds.

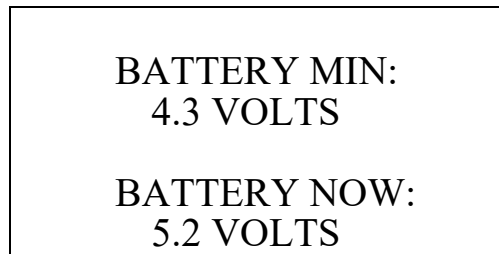

5. The Inert Mode Selection Screen will then be displayed.

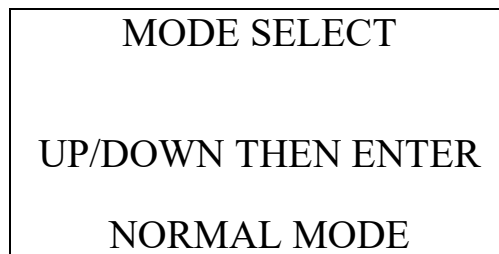

Use the AIR ▲ YES or RANGE ▼ SHIFT button to display the mode you wish to enter. To use the EAGLE 2 for tank tester applications, ensure that the float probe is

connected and select Inert Mode. To use the EAGLE 2 in Normal Mode, select Normal Mode and refer to “Measuring Mode, Normal Operation” on page 33. If you have not made a selection after 20 seconds, the instrument will begin to beep and the LEDs will begin to flash. They will continue until you make a selection.

**WARNING:** *The EAGLE 2 is not a gas monitoring device until you select a mode and enter it.*

6. The warm up sequence will continue as described in “Start Up” on page 27. The oxygen alarms in the alarm point screens will be the alarm points for Inert Mode and not for Normal Mode.
7. When the warm up is complete and the instrument is operating in Inert Mode, the screen will appear as shown below if the instrument is sampling a fresh air environment. The screen is shown with %LEL and oxygen channels. Your unit may only have %LEL.

I	CH4	0%LEL
N	OXY	20.9vol%ALRM2
E		
R		
T		

If the instrument is sampling a fresh air environment, the oxygen channel will be in alarm. For more information about Inert Mode, see “Appendix N: Using the EAGLE 2 in Inert Mode” on page 261.

8. When monitoring for combustible gas in an inerted tank, be sure the dilution fitting is installed and multiply the combustible gas reading by 2.  
When monitoring for oxygen in an inerted tank, remove the dilution fitting or seal the dilution hole with your finger.

---

## Alarms

The EAGLE 2 Tank Tester model has two sets of oxygen alarm settings, one for Normal Mode and one for Inert Mode. The Inert Mode oxygen alarms are factory-set at 5.0% by volume (rising) and 10.0% by volume (rising). Normal Mode oxygen alarm setpoints also exist and take effect when you select Normal Mode at start up.

The *rising* Inert Mode alarms are used to monitor a purged vessel to alert you to a rising oxygen condition.

The oxygen level in a fresh air environment is above both Inert Mode oxygen alarm points so the EAGLE 2 Tank Tester version *will* go into alarm when turned on in Inert Mode in a fresh air environment. To silence the alarm, press the RESET button. The audible alarm silences, but the alarm lights continue to flash and the display screen continues to indicate an oxygen alarm. If one of the alarm levels is newly exceeded, the audible alarm sounds again.

For information about viewing and changing the standard alarms used in Normal Mode, see “Updating the Alarm Point Settings” on page 106. For information about viewing and changing Inert Mode oxygen alarms, see “Appendix N: Using the EAGLE 2 in Inert Mode” on page 261.

---

## Calibration

Use a hexane calibrating source to calibrate the combustible gas LEL range. Use a 100% nitrogen calibrating source to set the zero reading for the oxygen channel. RKI Instruments, Inc. recommends using the Single Calibration method to calibrate the EAGLE 2 Tank Tester model. See “Chapter 4: Calibration Mode” on page 54. The instructions in that section call for calibrating the EAGLE 2 with methane. When following these instructions, be sure to calibrate with hexane rather than methane.

**NOTE:** Do not calibrate the EAGLE 2 Tank Tester model with the dilution fitting attached to the inlet fitting.

---

## Parts List

Table 36 lists part numbers for replacement parts and accessories of the EAGLE 2’s Tank Tester model.

**Table 36: Parts List: EAGLE 2 Tank Tester Model**

Part Number	Description
80-0405RK	Dilution fitting (1:1)
80-0802RK	Float probe (12-foot)

# Appendix N: Using the EAGLE 2 in Inert Mode

Inert Mode is used to measure the combustible gas and/or oxygen level in a purged environment. The oxygen alarms in this mode are both increasing and are generally set at 5.0% and 10.0%.

---

## Description

Inert Mode is factory activated for instruments that require it. The instrument can still be used in Normal Mode for other applications.

It is recommended that either an IR CH<sub>4</sub> or an IR HC sensor be installed in a unit that is used to monitor combustible gas in Inert Mode since it does not require oxygen to work properly. The catalytic LEL sensor does not operate at oxygen concentrations below 10% volume. If it is necessary to use the catalytic LEL sensor in Inert Mode, a dilution fitting must be installed. Installing a dilution fitting will affect the oxygen reading since you're introducing oxygen into the sample.

---

## Alarms

The oxygen channel alarm points in Inert Mode are different from those in Normal Mode. All other alarm point settings remain unchanged.

Since the application for Inert Mode is to detect a rising oxygen level in purged environments, both oxygen alarms are set to rising. The factory set alarm point is 5.0% volume for the low alarm and 10.0% volume for the high alarm. These alarm points are user adjustable in Setup Mode. See “Updating the Alarm Point Settings” on page 106 for instructions to set the alarm points for channels other than oxygen or to set the Normal Mode oxygen alarm points.

Below are instructions to set the Inert Mode oxygen alarms.

1. Take the EAGLE 2 to a non-hazardous location and turn it off if it is on.
2. Press and hold the AIR ▲ YES or RANGE ▼ SHIFT buttons, then press and hold the POWER ENTER RESET button. When you hear a beep, release the buttons.
3. The LCD will show the following screen for a few seconds with the “S” in the lower right corner indicating the unit is entering Setup Mode.



- The “S” will then disappear and the following screen will appear for a few seconds.



- If the unit prompts you for the password, enter it by using the AIR ▲ YES or RANGE ▼ SHIFT buttons to select each password number and then pressing and releasing the POWER ENTER RESET button to enter it and move on to the next number until all of the numbers are entered. The main menu displays. It displays six menu items at a time.

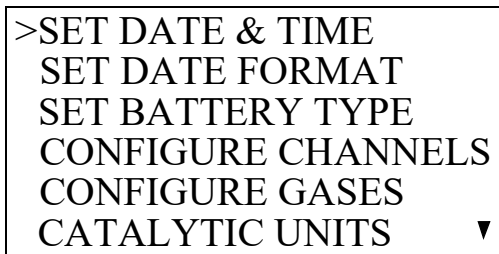

- Use the AIR ▲ YES or RANGE ▼ SHIFT button to move the cursor to the **ALARM POINTS** menu item.
- Press and release POWER ENTER RESET. The Change Alarm Point Settings Screen appears and all detection channels are displayed.

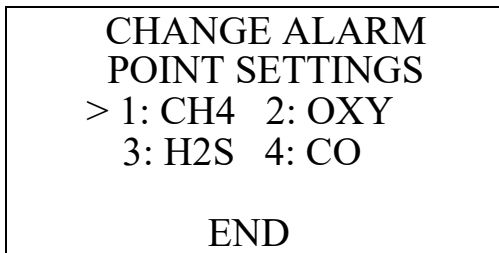

- Move the cursor next to the oxygen channel. Press and release POWER ENTER RESET.
- A mode select screen will appear and prompt you to choose between Normal Mode and Inert Mode. Use the AIR ▲ YES or RANGE ▼ SHIFT button to display Inert Mode and press and release POWER ENTER RESET.

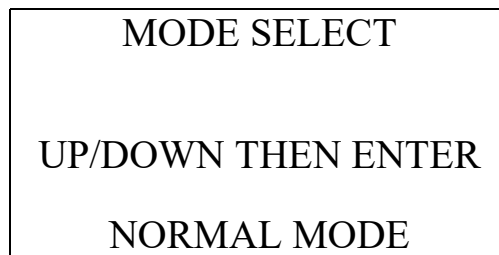

**NOTE:** To change the Normal Mode oxygen other alarm points, select Normal Mode and see “Updating the Alarm Point Settings” on page 106.

OXY 0- 40.0 vol%		
INERT ALARM		
>LO	:	5.0 vol%
HI	:	10.0 vol%
END		

10. Press and release POWER ENTER RESET. The alarm point or alarm operation (oxygen only) will begin to flash.
11. Use AIR ▲ YES and RANGE ▼ SHIFT to adjust the alarm point to the desired setting. Keep the following in mind:
  - The low alarm cannot be set higher than the high alarm and the high alarm cannot be set lower than the low alarm.
  - Any alarm setting can be turned off by adjusting it to its lowest setting. The setting will be displayed as **OFF**.
12. If you want to continue with the change, press and release POWER ENTER RESET to accept the setting.

If you want to exit this screen without saving any change to the alarms, press and release DISPLAY ADJUST NO until you return to the Change Alarm Point Settings Screen.

13. When you are done making changes, use RANGE ▼ SHIFT to move the cursor next to **END**.
14. Press and release POWER ENTER RESET to save the new settings and return to the Change Alarm Point Settings Screen.
15. Use RANGE ▼ SHIFT to move the cursor next to **END**.
16. Press and release POWER ENTER RESET to return to the main menu.

---

## Start Up

1. Press and briefly hold down the POWER ENTER RESET button. Release the button when you hear a beep.
2. The LCD will show the following screen for about ten seconds.

GAS MONITOR	
	
INSTRUMENTS	
EAGLE 2	

3. The Battery Voltage Screen appears for a few seconds.

BATTERY MIN:  
4.3 VOLTS  
  
BATTERY NOW:  
5.2 VOLTS

4. The Inert Mode Selection Screen will then be displayed.

MODE SELECT  
  
UP/DOWN THEN ENTER  
  
NORMAL MODE

Use the AIR ▲ YES or RANGE ▼ SHIFT button to display the mode you wish to enter. If you have not made a selection after 20 seconds, the instrument will begin to beep and the LEDs will begin to flash. They will continue until you make a selection.

**WARNING:** *The EAGLE 2 is not a gas monitoring device until you select a mode and enter it.*

5. If you select Normal Mode, the warm up sequence will continue as described in “Start Up” on page 27 unless Leak Check or Bar Hole Mode is active. If Leak Check or Bar Hole Mode is active, the Leak Check/Bar Hole Mode Select Screen will appear immediately after the Normal Mode selection.

> NORMAL MODE  
BAR HOLE MODE  
LEAK CHECK MODE

Use the AIR ▲ YES or RANGE ▼ SHIFT button to display the mode you wish to enter.

6. If you select Inert Mode, the warm up sequence will continue as described in “Start Up” on page 27. The oxygen alarms in the alarm point screens will be the alarm points for Inert Mode and not for Normal Mode.

7. When the warm up is complete and the instrument is operating in Inert Mode, the screen will appear as shown below if the instrument is sampling a fresh air environment.

I	CH4	0%LEL
N	OXY	20.9vol%ALRM2
E	H2S	0.0ppm
R	CO	0ppm
T		

If the instrument is sampling a fresh air environment, the oxygen channel will be in alarm.

---

## Operation

See “Measuring Mode, Normal Operation” on page 33 for operating instructions keeping in mind that the Inert Mode oxygen alarm settings are different.

You can access the Inert Mode Selection Screen while in Inert Mode or Normal Mode by pressing and holding the RANGE ▼ SHIFT button.

MODE SELECT
UP/DOWN THEN ENTER
NORMAL MODE

Use the AIR ▲ YES or RANGE ▼ SHIFT button to display the mode you wish to enter and press and release the POWER ENTER RESET button.

# Appendix O: EAGLE 2 Transformer Gas Tester Model

This EAGLE 2 Transformer Gas Tester Model is specially set up for electrical transformer gas testing. Large electrical transformers are filled with oil which surrounds the transformer coils, and they have an inert gas head space above the oil. When a transformer begins to fail, electrical arcing between the conductors of the coils can cause flammable gases to form in the head space. By testing the head space for these gases, and recording trends of the readings, an early warning of transformer failure can be determined, and the transformer can be removed from service before it explodes.

---

## Description

The standard setup and calibration for the catalytic combustible channel on a Transformer Gas Tester Model setup is for hydrogen with a range of 0 - 5.00% volume. When set up this way, the catalytic sensor will not respond to or will respond only slightly to the presence of methane.

Since the head space being tested is filled with nitrogen, there is no oxygen in the test sample. The catalytic sensor requires oxygen in order to operate, so the instrument is supplied with a snap-on dilution fitting with a dilution ratio of 1:1 (one part air to one part sample). This fitting blends the sample with ambient air before entering the instrument, which provides sufficient oxygen for the sensor to work.

The instrument is also supplied with a sample bag.

---

## Operation

1. Turn the instrument on and allow it to warm up.
2. Attach the dilution fitting directly to the front of the instrument. Attach the probe to the dilution fitting.
3. Press the AIR ▲ YES button in fresh air to zero the instrument.
4. Connect the deflated sample bag to the sample valve on the transformer and open the valve slightly to fill the sample bag. Close off the sample bag and remove it from the transformer valve.
5. Attach the sample bag to the probe and open the sample bag.

The sample will now be drawn into the instrument. After about 45 seconds note and record the display reading. Compare this reading to historical data to determine the condition of the transformer.

**NOTE:** The EAGLE 2 can be calibrated either with or without the dilution fitting in place. If calibrated without the dilution fitting in place, then display readings must be doubled to determine the actual gas concentration. If calibrated with the dilution fitting in place, then the sample bag must be used during calibration, and the display readings will be the actual gas concentrations.

**CAUTION:** *If the dilution fitting is in place for calibration, do not use a demand flow regulator. Use a sample bag. The use of a demand flow regulator with a dilution fitting when calibrating will result in an inaccurate calibration.*

---

## Alarms

All the gas alarms on the Transformer Gas Tester are set to OFF.

---

## Part List

**Table 37: Parts List: Eagle Tank Tester Model**

Part Number	Description
80-0405RK	Dilution fitting (1:1)
81-1126RK	Sample bag, 9" x 9", tedlar

# Appendix P: Internal Dilution Models

This appendix describes versions of the EAGLE 2 that contain an internal dilution fitting.

---

## Description

Internal dilution versions of the EAGLE 2 have a 1:1 dilution fitting installed in the bottom case. The dilution fitting blends ambient air into the incoming sample to provide sufficient oxygen for the catalytic LEL sensor to function properly. The flow system is arranged to allow the LEL sensor to see diluted sample while all other installed sensors see normal, undiluted sample.

A vent is installed on the right side of the bottom case when viewing the instrument from the front. This equalizes the pressure inside the EAGLE 2 as the instrument draws air from inside the case through the dilution fitting's hole.

The flow diagram for the internal dilution version is shown below. Depending on your particular version, you may not have all of the sensor shown below. Any unused sensors are replaced with a dummy sensor.

---

## Calibration

The instrument must be calibrated with a sample bag. See “Appendix A: Calibrating with a Sample Bag” for instructions.

---

## Warranty

RKI Instruments, Inc. warrants the EAGLE 2 sold by us to be free from defects in materials, workmanship, and performance for a period of two years from the date of shipment from RKI Instruments, Inc. This includes the instrument and the original sensors. Replacement parts are warranted for 1 year from the date of their shipment from RKI Instruments, Inc. PID sensors are warranted for 1 year from date of shipment from RKI Instruments, Inc. whether they are new or a replacement part. Any parts found defective within their warranty period will be repaired or replaced, at our option, free of charge. This warranty does not apply to those items which by their nature are subject to deterioration or consumption in normal service, and which must be cleaned, repaired, or replaced on a routine basis. Examples of such items are:

Absorbent cartridges

Filter elements, disks, or sheets

Pump diaphragms and valves

PID sensor electrode stacks

Warranty is voided by abuse including mechanical damage, alteration, rough handling, or repair procedures not in accordance with the instruction manual. This warranty indicates the full extent of our liability, and we are not responsible for removal or replacement costs, local repair costs, transportation costs, or contingent expenses incurred without our prior approval.

THIS WARRANTY IS EXPRESSLY IN LIEU OF ANY AND ALL OTHER WARRANTIES AND REPRESENTATIONS, EXPRESSED OR IMPLIED, AND ALL OTHER OBLIGATIONS OR LIABILITIES ON THE PART OF RKI INSTRUMENTS, INC. INCLUDING BUT NOT LIMITED TO THE WARRANTY OF MERCHANTABILITY OR FITNESS FOR A PARTICULAR PURPOSE. IN NO EVENT SHALL RKI INSTRUMENTS, INC. BE LIABLE FOR INDIRECT, INCIDENTAL, OR CONSEQUENTIAL LOSS OR DAMAGE OF ANY KIND CONNECTED WITH THE USE OF ITS PRODUCTS OR FAILURE OF ITS PRODUCTS TO FUNCTION OR OPERATE PROPERLY.

This warranty covers instruments and parts sold to users only by authorized distributors, dealers, and representatives as appointed by RKI Instruments, Inc.

We do not assume indemnification for any accident or damage caused by the operation of this gas monitor and our warranty is limited to replacement of parts or our complete goods.