

IPAQ C530/R530 Technical Datasheet

Smart 2-wire universal transmitter
with HART[®] 7 and NFC technology

- NFC - Configuration of the transmitter via a portable device such as a smartphone.
- HART[®] 7 protocol
- High accuracy and long-term stability
- Efficient PC-configuration without external power



The documentation is only complete when used in combination with the relevant documentation for the sensor.

1	Product features	3
1.1	Smart 2-wire universal transmitter with HART [®] 7 and NFC technology	3
1.2	Options and variants	5
1.3	Measuring principles	6
1.3.1	Resistance temperature sensor	6
1.3.2	Thermocouples	7
2	Technical data	8
2.1	Technical data	8
2.2	Dimensions	13
2.3	Temperature data for areas with potentially explosive atmospheres	14
2.4	Output load diagram	15
2.5	Electrical data for outputs and inputs	16
2.6	RTD and T/C accuracy table	17
3	Installation	19
3.1	Intended use	19
3.2	In-head transmitter	20
3.3	Rail-mount transmitter	21
4	Electrical connections	22
4.1	Notes on installation	22
4.2	Electrical connections of in-head transmitter	22
4.3	Connection diagram of in-head transmitter	24
4.4	Connection diagram of in-head transmitter (intrinsically safe)	25
4.5	Electrical connections of rail-mount transmitter	26
4.6	Connection diagram of rail-mount transmitter	27
4.7	Connection diagram of rail-mount transmitter (intrinsically safe)	27
4.8	Cable length	28
5	Order information	29
5.1	Order code	29
6	Notes	32

1.1 Smart 2-wire universal transmitter with HART[®] 7 and NFC technology

The 530 series is a universal, isolated transmitter for temperature, resistance or voltage measurements of solids, fluids and gases in an industrial environment.

The 530 series consists of two different versions. C530 is primarily intended to be mounted in a DIN-B housing whereas R530 is the rail-mount version. This transmitter family utilizes a modular design in hardware as well as in software to ensure the quality and reliability of the transmitter signal output.

The transmitters are compatible with the HART[®] 7 protocol offering extended diagnostic information (device error, sensor and wiring conditions). Typical characteristics are the high accuracy, stability and reliability combined with a robust housing.

NFC features enables wireless communication and configuration between transmitter and a portable device such a smartphone.



- ① In-head transmitter
- ② Rail-mount transmitter

Highlights**High measurement accuracy**

- Long-term stability: drift over 5 years is the maximum of $\pm 0.05^{\circ}\text{C}$ or $\pm 0.05\%$ of span
- High precision: $\pm 0.1^{\circ}\text{C}$ / $\pm 0.18^{\circ}\text{F}$ or 0.05% of span (example Pt100)

High reliability

- Robust design: 10g vibrations, 95% RH and robust terminals

High safety

- NAMUR compliant to NE 21, NE 43, NE 53 and NE 107
- ATEX and IECEx (intrinsically safe); In preparation: CSA, FM and GOST

High user efficiency

- NFC - Wireless communication enables easy configuration with a portable device such as a smartphone.
- Easy configuration, installation and maintenance with ConSoft, HART[®] 7 protocol, EDD plus DTM/FDT enabled systems

Industries

- Chemicals
- Oil & Gas
- Power industry
- Iron, Steel & Metal
- Pulp & Paper
- Food & Beverage
- Pharmaceuticals

1.2 Options and variants

C530: in-head transmitter



The C530 is a smart, universal HART®- compatible 2-wire in-head transmitter for temperature, resistance or voltage measurements in an industrial environment.

The C530 is optionally available in an intrinsically safe version for use in zone 0, 1 and 2.

All variants are intended for installation in a DIN B head or larger according to DIN EN 50446.

R530: rail-mount transmitter



The R530 is a smart, universal HART®- compatible 2-wire rail-mount transmitter for temperature, resistance or voltage measurements in an industrial environment.

The R530 is optionally available in an intrinsically safe version for use in zone 0, 1 and 2.

All variants are intended for installation on a DIN rail according to EN 60715 / DIN 50022.

1.3 Measuring principles

The kind of the measuring principle depends on the measuring insert that you combine with the transmitter. In matters of the thermometer type the manufacturer offers two different measuring inserts, either with a resistance thermometer or with a thermocouple. This transmitter supports both types.

1.3.1 Resistance temperature sensor

The measuring insert with a temperature-sensitive sensor made from a platinum (Pt) RTD, whose value at 0°C / +32°F is 100 Ω. That is where the name "Pt100" comes from.

It is generally valid that the electric resistance of metals increases according to a mathematical function as the temperature rises. This effect is taken advantage of by resistance temperature sensors to measure temperature. The "Pt100" temperature sensors features a measuring resistance with defined characteristics, standardised in IEC 60751. The same is true for the tolerances. The average temperature coefficient of a Pt100 is $3.85 \times 10^{-3} \text{ K}^{-1}$ in the range from 0...+100°C / +32...+212°F.

During operation, a constant current I ($\leq 1 \text{ mA}$) flows through the Pt100 RTD, which brings about a voltage drop U . The resistance R is calculated using Ohm's Law ($R=U/I$). As the voltage drop U at 0°C / +32°F is 100 mV, the resulting resistance of the Pt100 temperature assembly is 100 Ω (100 mV / 1 mA = 100 Ω).

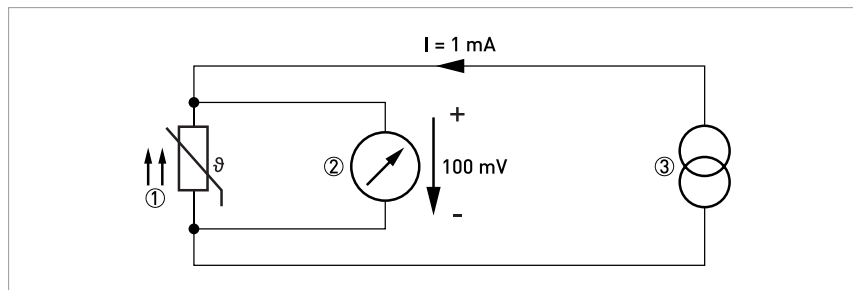

Figure 1-1: Pt100 resistance temperature sensor in 4-wire connection at 0°C / +32°F, schematic.

- ① Pt100 RTD
- ② Voltage meter
- ③ Current source

1.3.2 Thermocouples

The thermocouple features two electric conductors made from different metals, connected at one end. Each free end is connected to a compensation cable which is then connected to a millivolt meter. This circuitry forms a "thermal circuit". The point at which the two electric conductors connect is called the measuring point and the point at which the compensation cables connect to the conductors of the millivolt meter is called the cold junction.

If the measuring point of this thermal circuit is heated up, a small electrical voltage (thermal voltage) can be measured. If, however, the measuring point and the cold junction are at the same temperature, no thermoelectric voltage is generated. The degree of thermoelectric voltage, also known as electromotive force (EMF), depends on the thermocouple material and the extent of the temperature difference between the measuring point and the cold junction. It can be measured using the millivolt meter with no auxiliary power.

Simply put, the thermocouple behaves like a battery, the voltage of which also increases as the temperature rises.

The characteristic curves and tolerances of commercially available thermocouples are standardised in IEC 60584.

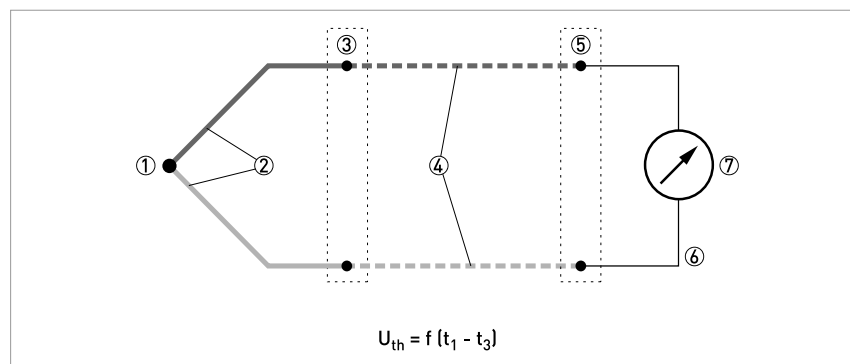

Figure 1-2: Thermocouple measuring circuit, schematic.

- ① Measuring point t_1 (hot junction)
- ② Thermocouple
- ③ Transition junction t_2
- ④ Compensation cable / extension cable
- ⑤ Reference junction t_3 (cold junction)
- ⑥ Copper conductor
- ⑦ Voltage meter U_{th}

2.1 Technical data

- *The following data is provided for general applications. If you require data that is more relevant to your specific application, please contact us or your local sales office.*
- *Additional information (certificates, special tools, software,...) and complete product documentation can be downloaded free of charge from the website.*

Measuring system

Application range	Temperature measurements of solids, liquids and gases in industrial environment.
-------------------	--

Design

Versions	
C530	In-head transmitters which are intended for installation in a DIN B-head or larger according to DIN EN 50446. This transmitter is optionally available in an intrinsically safe version (Zone 0, 1 and 2) for installation in potentially explosive atmospheres.
R530	Rail-mount transmitters which are intended for installation on a DIN-rail according to DIN 50022 / EN 60715, 35 mm / 1.38". The transmitter is optionally available in an intrinsically safe version (Zone 0, 1 and 2) for installation in potentially explosive atmospheres.
Features	
HART® compliance	The transmitters are fully compliant with the HART® 7 protocol. HART® 7 offers the possibility to receive diagnostic information such as sensor errors or sensor conditions, transmitter error, etc.
NFC®	NFC® enables wireless communication and configuration between transmitter and a portable device such a smartphone.
Sensor matching	A matching to a calibrated temperature sensor can easily be performed by entering the sensor deviation in the low and high ends of the measuring ranges.
Customized linearization	For resistance and mV inputs, either a 50-point Customized Linearization table or via Callendar-Van Dusen (Applies only to RTD, $\alpha=0,00385$) constants can provide a correct process value.
PC programmable	Measuring ranges are set from PC.
	Full accuracy is provided without any need for calibration.
	Configuration without external power.
Runtime counter	Hour counter for elapsed operational time
Simulated output	Fixed current output during a maximum time of 15 min

Measuring accuracy

Accuracy & Stability	Basic accuracy is max. of $\pm 0.08^\circ\text{C}$ or $\pm 0.08\%$ of span.
Ambient temperature influence	RTD and Thermocouple: for detailed information refer to <i>RTD and T/C accuracy table</i> on page 17.
	Resistance: $\pm 0.01\% < 4000\ \Omega$ (2000 Ω at 2-wire) $< \pm 0.02\%$ of span per $^\circ\text{C}$
	Voltage: $\pm 0.01\%$ of span per $^\circ\text{C}$
Supply voltage influence	$< \pm 0.005\%$ of span per V
Long-term drift	Max of $\pm 0.02\ ^\circ\text{C}$ or $\pm 0.02\%$ of span per year

Operating conditions

Temperature	
In-head transmitter	Operating and storage temperature: Standard version: -40...+85°C / -40...+185°F IS version: for detailed information refer to Temperature data for areas with potentially explosive atmospheres on page 14
Rail-mount transmitter	Operating and storage temperature: Standard version: -40...+85°C / -40...+185°F IS version: for detailed information refer to Temperature data for areas with potentially explosive atmospheres on page 14
Humidity	0...98% RH (non-condensing)
Protection category	
In-head transmitter	Housing: IP65 Terminals: IP00
Rail-mount transmitter	Housing: IP20 Terminals: IP20

Installation conditions

Mounting	In-head transmitter: DIN B-head or larger, DIN-rail (with adapter)
	Rail-mount transmitter: DIN-rail acc. to DIN 50022 / EN 60715, 35 mm / 1.38"
	For detailed information refer to <i>Installation</i> on page 19.
Weight	In-head transmitter: 35 g / 0.07 lb
	Rail-mount transmitter: 70 g / 0.15 lb
Dimensions	For detailed information refer to <i>Dimensions</i> on page 13.

Materials

Housing	PC/ABS + PA
Flammability acc. to UL	In-head transmitter: V0
	Rail-mount transmitter: V0/HB

Electrical connections

Power supply	Standard version: 8,5...36 VDC
	IS version: 8,5...30 VDC
Isolation	Galvanically isolated (in-out), 1500 VAC, 1 minute
Connection	Single/stranded wires: max. 1.5 mm ² / AWG 16
Terminal	Single/stranded wires: max 1.5 mm ² , Max 0.5 Nm torque
Reverse Polarity Protection	Yes

Inputs / Outputs

Input - RTD	
Pt100 (IEC 60751, $\alpha = 0.00385$)	-200...+850°C / -328...+1562°F
Pt100 (JIS C1604-1981, $\alpha = 0.003916$)	
PtX ($10 \leq X \leq 1000$) (IEC 60751, $\alpha = 0.00385$)	The upper range depends on the X value, max. input temperature corresponding to 4000 Ω .
Ni100 (DIN 43760)	-60...+250°C / -76...+482°F
Ni120 (Edison No. 7)	

Ni1000 (DIN 43760)	-50...+180°C / -58...+356°F
Cu10 (Edison Copper Windings No. 15)	-50...+200°C / -58...+392°F
Sensor current	≤300 μA
Maximum sensor wire resistance	3- and 4-wire connection 50 Ω/wire 2-wire connection Compensation for 0 to 100 Ω loop resistance
Adjustment	Minimum span 10°C / 18°F Sensor error compensation ±10% of span for span <50°C/90°F, otherwise ±5°C/±9°F
Input - resistance / potentiometer	
Range (resistance)	0...10000 Ω
Range (potentiometer)	100...10000 Ω
Zero adjustment	Within range
Max offset adjustment	50% of selected max value
Minimum span	10 Ω
Sensor current	≤300 μA
Customized linearization	Up to 50 points
Maximum sensor wire resistance	In-head transmitter: 50 Ω / wire Rail-mount transmitter: 50 Ω / wire
Input - thermocouples	
T/C type B - Pt30Rh-Pt6Rh (IEC 60584)	400...+1800°C / +752...+3272°F
T/C type C - W5Re-W26Re (ASTM E 988)	0...+2315 °C / 32...+4199°F
T/C type D - W3Re-W25Re (ASTM E 988)	0...+2315 °C / 32...+4199°F
T/C type E - NiCr-CuNi (IEC 60584)	-270...+1000°C / -454...+1832°F
T/C type J - Fe-CuNi (IEC 60584)	-210...+1200°C / -346...+2192°F
T/C type K - NiCr-NiAl (IEC 60584)	-270...+1300°C / -454...+2372°F
T/C type N - NiCrSi-NiSi (IEC 60584)	-270...+1300°C / -148...+2372°F
T/C type R - Pt13Rh-Pt (IEC 60584)	-50...+1750°C / -58...+3182°F
T/C type S - Pt10Rh-Pt (IEC 60584)	-50...+1750°C / -58...+3182°F
T/C type T - Cu-CuNi (IEC 60584)	-270...+400°C / -454...+752°F
Input impedance	>10 MΩ
Maximum wire loop resistance	In-head transmitter (Including T/C sensor): 5 kΩ Field transmitter (Including T/C sensor): 10 kΩ
Cold Junction Compensation (CJC)	Internal, external (Pt100) or fixed
Input - voltage	
Range	-10...+1000 mV
Zero adjustment	Within range
Minimum span	2 mV
Customized linearization	Up to 50 points
Input impedance	>10 MΩ
Maximum wire loop resistance	In-head transmitter: 5 kΩ Field transmitter / Switch room transmitter: 10 kΩ
Output	
Output signal	4...20 mA, 20...4 mA; temperature, resistance or voltage linear, customized linearization possible.

HART®	
HART® protocol	HART® 7
HART® physical layer	FSK 1200
Permissible load	(Supply voltage-8)/0.022
NAMUR compliance	Output limits and failure currents acc. to NAMUR NE 43
Adjustable filtering level	0.17 to 90 s, (default 1.4 s) (3-wire RTD)
Monitoring	Sensor break and short circuit monitoring, selectable, upscale ≥ 21.0 mA or downscale ≤ 3.6 mA action, individually configurable.
Configuration	
ConSoft	The PC configuration software, ConSoft, is a versatile and user-friendly tool for transmitter configuration.
	Consoft is compatible with Windows XP/Vista/7/8/8.1/10
	ConSoft is part of the complete configuration kit, which also contains a USB Interface and necessary cables. Full functionality of the transmitter is achieved with ConSoft program version 3.3.0 or later and the firmware in the USB Interface must have a version number 1.2.07 or later.
INOR Connect	The app INOR Connect for portable devices (smartphones) is a versatile and user-friendly tool for wireless configuration through Bluetooth® or NFC® technology. Communication via Bluetooth® requires the Bluetooth® interface - ICON-BT, which can be ordered from the manufacturer.
Alternatives	Hand held communicator, e.g. FC 475 (Emerson)
	Management systems, e.g. AMS (Emerson) and PDM (Siemens)
	EDD enabled systems
	DTM/FDT enabled systems

Approvals and certifications

CE	The device fulfils the statutory requirements of the EC directives. The manufacturer certifies that these requirements have been met by applying the CE marking.
Ex approvals	
Standard version	Without
Intrinsically safe (IS) version	See Ex approvals in separate table below.
Other standards and approvals	
Electromagnetic compatibility	Directive: 2014/30/EU
	Harmonized standards: EN 61326-1 and EN 61326-2-3
	NAMUR NE 21
	EN 61326-1 and -2-3: Criteria A NE 21: <0,5% of span
RoHS	Directive: 2011/65/EU Harmonized standard: EN 50581:2012
Vibration resistance	Acc. to IEC 60068-2-6, test Fc, 10...2000 Hz, 10 g
Radio Equipment Directive	This product contains NFC communication and conform to the requirements of the Radio Equipment Directive (RED).

Ex approvals

C530X (intrinsically safe)		
ATEX	KIWA 17ATEX0053 X	II 1G Ex ia IIC T6...T4 Ga
IECEX	IECEX KIWA 17.0027X	Ex ia IIC T6...T4 Ga
R530X (intrinsically safe)		
ATEX	KIWA 17ATEX0055 X	II 1G Ex ia IIC T6...T4 Ga
IECEX	IECEX KIWA 17.0029X	Ex ia IIC T6...T4 Ga

2.2 Dimensions

In-head transmitter

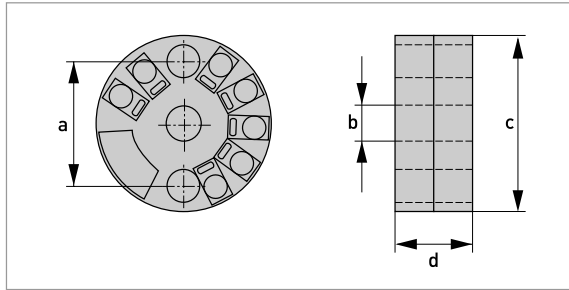

	Dimensions	
	[mm]	[inch]
a	33.0	1.30
b	7.0	0.28
c	44.5	1.75
d	19,5	0.77

Rail-mount transmitter

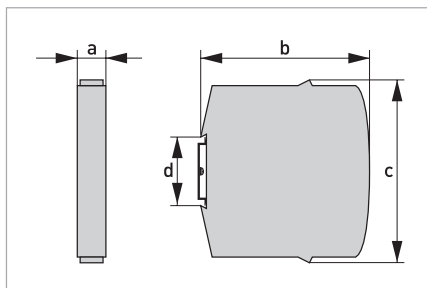

	Dimensions	
	[mm]	[inch]
a	17.5	0.69
b	81.3	3.20
c	90.0	3.54
d	35	1.38

2.3 Temperature data for areas with potentially explosive atmospheres

In-head transmitter

Intrinsically safe transmitter

Temperature class	Ambient temperature T_a
T6	$-40^{\circ}\text{C} \leq T_a \leq +60^{\circ}\text{C}$ / $-40^{\circ}\text{F} \leq T_a \leq +140^{\circ}\text{F}$
T5	$-40^{\circ}\text{C} \leq T_a \leq +75^{\circ}\text{C}$ / $-40^{\circ}\text{F} \leq T_a \leq +167^{\circ}\text{F}$
T4	$-40^{\circ}\text{C} \leq T_a \leq +85^{\circ}\text{C}$ / $-40^{\circ}\text{F} \leq T_a \leq +185^{\circ}\text{F}$

Rail-mount transmitter

Intrinsically safe transmitter

Temperature class	Ambient temperature T_a
T6	$-40^{\circ}\text{C} \leq T_a \leq +60^{\circ}\text{C}$ / $-40^{\circ}\text{F} \leq T_a \leq +140^{\circ}\text{F}$
T5	$-40^{\circ}\text{C} \leq T_a \leq +75^{\circ}\text{C}$ / $-40^{\circ}\text{F} \leq T_a \leq +167^{\circ}\text{F}$
T4	$-40^{\circ}\text{C} \leq T_a \leq +85^{\circ}\text{C}$ / $-40^{\circ}\text{F} \leq T_a \leq +185^{\circ}\text{F}$

2.4 Output load diagram

Formula for the maximum permissible output load:
 permissible $R_{Load} [\Omega] = (U-8,5)/0.022$

Shaded areas shows the working area of the HART® communication.

Standard transmitter

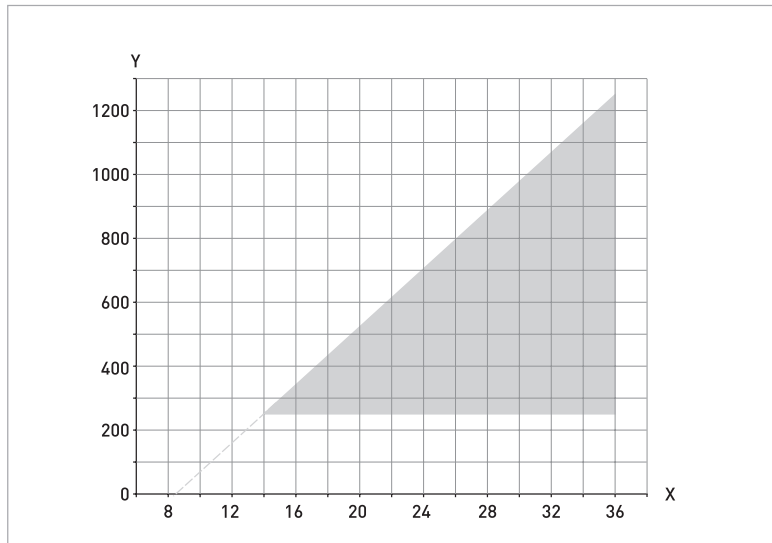

Figure 2-1: Output load diagram.

X: Power supply U [VDC]
 Y: Total output load R [Ω]

Intrinsically safe transmitter

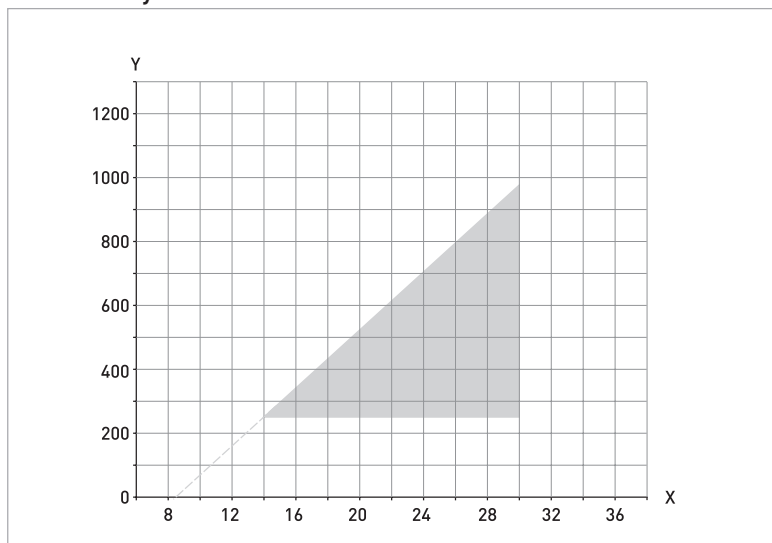

Figure 2-2: Output load diagram

X: Power supply U [VDC]
 Y: Total output load R [Ω]

2.5 Electrical data for outputs and inputs

In-head transmitter

Intrinsically safe transmitter C530X

Output terminals 6, 7		Input terminals 1, 2, 3, 4	
$U_i = V_{\max}$	≤ 30 VDC	$U_o = U_{0C}$	≤ 6.5 VDC
$I_i = I_{\max}$	≤ 100 mA	$I_o = I_{SC}$	≤ 11.7 mA
$P_i = P_{\max}$	≤ 900 mW	P_o	≤ 19.1 mW
L_i	20 μ H	L_o	400 mH
C_i	23.1 nF	C_o	24 μ F

Rail-mount transmitter

Intrinsically safe transmitter R530X

Output terminals 21, 22		Input terminals 1, 2, 3, 4	
$U_i = V_{\max}$	≤ 30 VDC	$U_o = U_{0C}$	≤ 6.5 VDC
$I_i = I_{\max}$	≤ 100 mA	$I_o = I_{SC}$	≤ 11.7 mA
$P_i = P_{\max}$	≤ 900 mW	P_o	≤ 19.1 mW
L_i	20 μ H	L_o	400 mH
C_i	23.1 nF	C_o	24 μ F

2.6 RTD and T/C accuracy table

Typical accuracy $\pm 0,08\%$ of span , max of $\pm 0,1K$ or $\pm 0,1\%$ of span.

Conformance level 95% (2σ)

CJC = Cold Junction Compensation

Accuracies in °C

Input type	Temp. range	Min. span	Accuracy (Maximum of)	Temp. influence (Dev. from ref. temp. 20°C)
	[°C]	[°C]	[°C]	
RTD Pt100	-200...+850	10	$\pm 0.08^\circ\text{C}$ or $\pm 0.08\%$ of span	$\pm 0.01\%$ of span per C
RTD PtX ①	Corresp. to max. 4 k Ω	10	$\pm 0.1^\circ\text{C}$ or $\pm 0.1\%$ of span	$\pm 0.01\%$ of span per C
RTD Ni100	-60...+250	10	$\pm 0.1^\circ\text{C}$ or $\pm 0.1\%$ of span	$\pm 0.01\%$ of span per C
RTD Ni120	-60...+250	10	$\pm 0.1^\circ\text{C}$ or $\pm 0.1\%$ of span	$\pm 0.01\%$ of span per C
RTD Ni1000	-50...+180	10	$\pm 0.1^\circ\text{C}$ or $\pm 0.1\%$ of span	$\pm 0.01\%$ of span per C
RTD Cu10	-50...+260	83	$\pm 1.5^\circ\text{C}$ or $\pm 0.2\%$ of span	$\pm 0.02\%$ of span per C
T/C type B	+400...+1800	700	$\pm 1.0^\circ\text{C}$ or $\pm 0.2\%$ of span ②	$\pm 0.01\%$ of span per C
T/C type C	0...+2315	200	$\pm 1.0^\circ\text{C}$ or $\pm 0.2\%$ of span ②	$\pm 0.01\%$ of span per C
T/C type D	0...+2315	200	$\pm 1.0^\circ\text{C}$ or $\pm 0.2\%$ of span ②	$\pm 0.01\%$ of span per C
T/C type E	-270...+1000	50	$\pm 0.5^\circ\text{C}$ or $\pm 0.1\%$ of span ②	$\pm 0.01\%$ of span per C
T/C type J	-210...+1200	50	$\pm 0.5^\circ\text{C}$ or $\pm 0.1\%$ of span ②	$\pm 0.01\%$ of span per C
T/C type K	-270...+1300	50	$\pm 0.5^\circ\text{C}$ or $\pm 0.1\%$ of span ②	$\pm 0.01\%$ of span per C
T/C type N	-100...+1300	100	$\pm 0.5^\circ\text{C}$ or $\pm 0.1\%$ of span ②	$\pm 0.01\%$ of span per C
T/C type N	-270...-100	100	$\pm 1.0^\circ\text{C}$ ②	$\pm 0.1\%$ of span per C
T/C type R	-50...+1750	300	$\pm 1.0^\circ\text{C}$ or $\pm 0.1\%$ of span ②	$\pm 0.01\%$ of span per C
T/C type S	-50...+1750	300	$\pm 1.0^\circ\text{C}$ or $\pm 0.1\%$ of span ②	$\pm 0.01\%$ of span per C
T/C type T	-270...+400	50	$\pm 0.25^\circ\text{C}$ or $\pm 0.2\%$ of span ②	$\pm 0.01\%$ of span per C

① ($10 \leq X \leq 1000$)

② CJC error not included. $\leq 0,5^\circ\text{C}$ within ambient temperature range

Accuracies in °F

Input type	Temp. range	Min. span	Accuracy (Maximum of)	Temp. influence (Dev. from ref. temp. 68°F)
	[°F]	[°F]	[°F]	
RTD PtX ①	Corresp. to max. 4 kΩ	18	±0.18°F or ±0.1% of span	±0.006% of span per F
RTD Ni100	-76...+482	18	±0.18°F or ±0.1% of span	±0.006% of span per F
RTD Ni120	-76...+482	18	±0.18°F or ±0.1% of span	±0.006% of span per F
RTD Ni1000	-58...+356	18	±0.18°F or ±0.1% of span	±0.006% of span per F
RTD Cu10	-58...+500	149	±2.7°F or ±0.2% of span	±0.006% of span per F
T/C type B	+752...+3272	1260	±1.8°F or ±0.1% of span ②	±0.006% of span per F
T/C type C	+32...+4199	360	±1.8°F or ±0.1% of span ②	±0.006% of span per F
T/C type D	+32...+4199	360	±1.8°F or ±0.1% of span ②	±0.006% of span per F
T/C type E	-454...+1832	90	±0.9°F or ±0.1% of span ②	±0.006% of span per F
T/C type J	-346...+2192	90	±0.9°F or ±0.1% of span ②	±0.006% of span per F
T/C type K	-454...+2372	90	±0.9°F or ±0.1% of span ②	±0.006% of span per F
T/C type N	-148...+2372	180	±0.9°F or ±0.1% of span ②	±0.006% of span per F
T/C type N	-454...-148	180	±1.8°F ②	±0.18% of span per F
T/C type R	-58...+3182	540	±1.8°F or ±0.1% of span ②	±0.006% of span per F
T/C type S	-58...+3182	540	±1.8°F or ±0.1% of span ②	±0.006% of span per F
T/C type T	-454...+752	90	±0.9°F or ±0.1% of span ②	±0.006% of span per F

① (10 ≤ X ≤ 1000)

② CJC error not included. ≤ 0,9°F within ambient temperature range

3.1 Intended use

The IPAQ 530 transmitter is an universal HART[®]-compatible 2-wire transmitter designed for temperature measurements and intended to be used in industrial environments.

- Temperature measurements with resistance thermometers
- Temperature measurements with thermocouples
- Voltage measurements in a range up to 1000 mV
- Resistance measurement up to 10 k Ω
- Measurements with potentiometers

The transmitters are configured from a PC by using the ConSoft software and a transmitter configuration kit (USB connection), by a HART[®]-configurator, by a HART[®]-modem and a suitable software, e.g. PactWare, or by a Smartphone with built in NFC support

Responsibility for the correct use of the devices with special regard to suitability, intended use and the field of application lies solely with the operator. To avoid any kind of incorrect use, also note the information in the chapter "Device description".

The transmitters do not contain any serviceable parts inside. Any substitution of components may impair the intrinsic safety of the versions with an Ex approval. Always send defective devices to the manufacturer or the local distributor for repair or exchange. If this is the case, attach a clear description of the malfunction for warranty claims.

The manufacturer is not liable for any damage resulting from improper use or use for other than the intended purpose. To avoid any kind of incorrect use, also note the information in the chapter "Device description"!

Responsibility for the use of the measuring devices with regard to suitability, intended use and corrosion resistance of the used materials against the measured fluid lies solely with the operator.

This device is a Group 1, Class A device as specified within CISPR11:2009. It is intended for use in industrial environment. There may be potential difficulties in ensuring electromagnetic compatibility in other environments, due to conducted as well as radiated disturbances.

3.2 In-head transmitter

The transmitter is intended for installation in DIN B connection heads or larger. The large $\varnothing 7$ mm / 0.28 inch center hole facilitates the electrical connection of the sensor and the installation. .

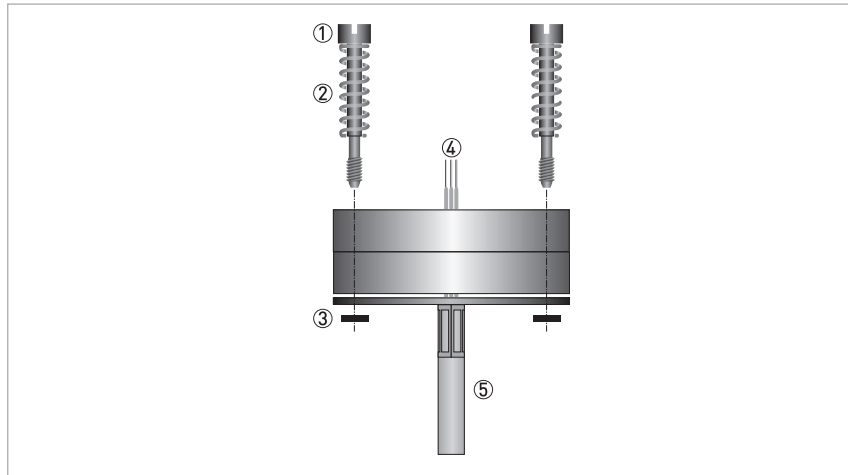

Figure 3-1: Connection head installation kit

- ① M4 screw
- ② Spring
- ③ Lock washer
- ④ Wires from the measuring inserts
- ⑤ MI Cable

The connection head installation kit does not belong to the standard scope of delivery of the transmitter, you have to order it separately.

The transmitter is optionally available in an intrinsically safe version (zone 0, 1 and 2) for installation in potentially explosive atmospheres. The intrinsically safe version must be supplied by an intrinsically safe power supply unit or Zener barrier placed outside of the potentially explosive zone. The Ex transmitter must be installed in a housing with the protection rating IP20 or better according to EN 60529 / IEC 60529.

The transmitter has been developed for an operating temperature of $-40...+85^{\circ}\text{C}$ / $-40^{\circ}\text{F}...+185^{\circ}\text{F}$. To avoid destruction or damage of the device, always assure that the operating temperature or ambient temperature does not exceed the permissible range. The thermowell also transfer the process temperature to the transmitter housing. If the process temperature is close to or exceeds the maximum temperature of the transmitter, then the temperature in the transmitter housing can rise above the maximum permissible temperature. One way to decrease the head transfer via thermowell is to install the transmitter further away from the heat source. Inversely similar measurements can be done if the temperature gets below specified minimum temperature.

3.3 Rail-mount transmitter

These transmitters are intended for installation on a 35 mm rail according to EN 60715 / DIN 50022.

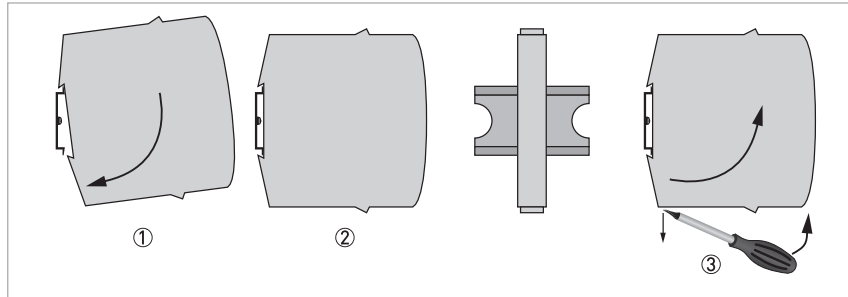

Figure 3-2: Rail installation

- ① Fix the upper part of the transmitter onto the rail.
- ② Press the lower part of the transmitter against the rail.
- ③ To remove the transmitter, bend the locking device using a small screwdriver. Carefully pull the transmitter in the forward direction.

The manufacturer has developed the R530 for an operating temperature range of -40...+85°C / -40...+185°F.

To avoid destruction or damage of the device, always note the following items:

- *Assure that the operating temperature or the ambient temperature does not exceed the permissible range.*

4.1 Notes on installation

Inspect the packaging carefully for damages or signs of rough handling. Report damage to the carrier and to the local office of the manufacturer.

Do a check of the packing list to make sure that you have all the elements given in the order.

Look at the device nameplate to ensure that the device is delivered according to your order.

4.2 Electrical connections of in-head transmitter

The input and output signals and the power supply must be connected in accordance with the following illustrations. The transmitter is easy to install with the connection head installation kit. To avoid measuring errors, all cables must be connected properly and the screws tightened correctly.

RTD and potentiometer measurement

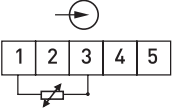
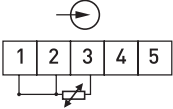
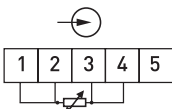
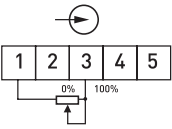
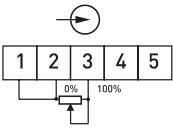
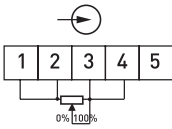
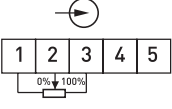
Pt100...Pt1000, Ni100, Ni120, Cu10 2-wire connection	Pt100...Pt1000, Ni100, Ni120, Cu10 3-wire connection	Pt100...Pt1000, Ni100, Ni120, Cu10 4-wire connection
		
<p>Resistance, 2-wire connection</p>	<p>Resistance, 3-wire connection</p>	<p>Resistance, 4-wire connection</p>
		
<p>Potentiometer, 3-wire slide wire</p>		
		

Thermocouple and voltage measurement

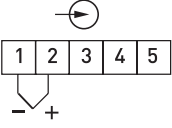
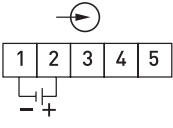
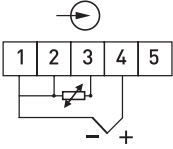
Thermocouple	Voltage	Thermocouple with external CJC (Pt100)
		

4.3 Connection diagram of in-head transmitter

To enable HART[®] communication, the output circuit must have an output load of at least 250 Ω .

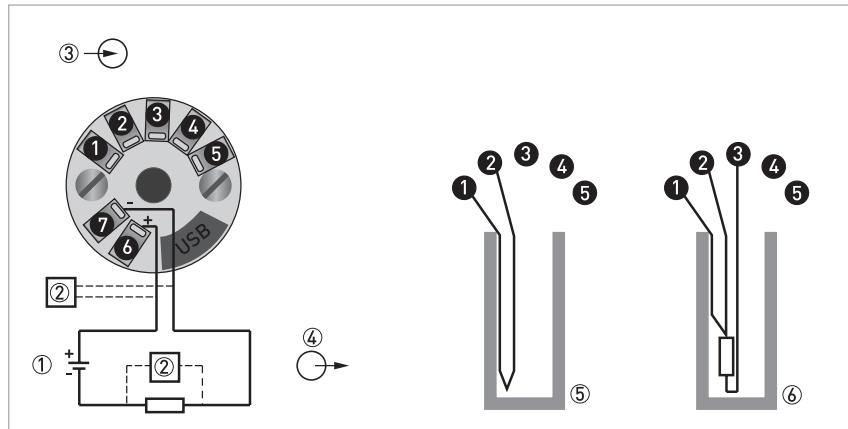

Figure 4-1: Connection diagram

- ① Voltage supply 8,5...36 VDC (terminals 6, 7)
- ② HART Modem
- ③ Input
- ④ Output
- ⑤ Thermocouple
- ⑥ Pt100 3-wire connection

The HART[®] modem is connected parallel to the output load or parallel to the output of the transmitter.

In order to ensure reliable HART[®] communication with this transmitter, the maximum cable length of the output circuit must be observed. For detailed information refer to Cable length on page 28.

4.4 Connection diagram of in-head transmitter (intrinsically safe)

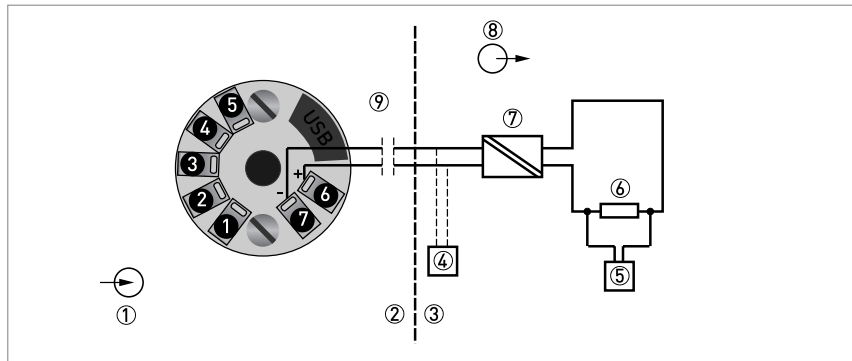

Figure 4-2: Connection diagram

- ① Input
- ② Potentially explosive area
- ③ Safe area
- ④ Modem, Ex-approved
- ⑤ HART Modem
- ⑥ $R_{Load}, R \geq 250 \Omega$
- ⑦ Zener barrier or voltage supply 8,5...30 VDC (intrinsically safe)
- ⑧ Output
- ⑨ See chapter "cable length"

The HART® modem is connected parallel to the output load or parallel to the output of the transmitter.

4.5 Electrical connections of rail-mount transmitter

The input and output signals and the power supply must be connected in accordance with the following illustrations. To avoid measuring errors, all cables must be connected properly and the screws tightened correctly.

RTD and potentiometer measurement

Pt100...Pt1000, Ni100, Ni120, Cu10 2-wire connection	Pt100...Pt1000, Ni100, Ni120, Cu10 3-wire connection	Pt100...Pt1000, Ni100, Ni120, Cu10 4-wire connection
Resistance, 2-wire connection	Resistance, 3-wire connection	Resistance, 4-wire connection
Potentiometer, 3-wire slide wire		

Thermocouple and voltage measurement

Thermocouple	Voltage	Thermocouple with external CJC (Pt100)

4.6 Connection diagram of rail-mount transmitter

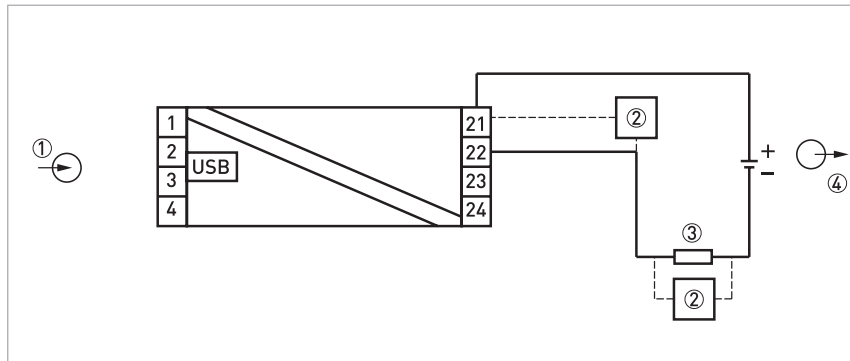

Figure 4-3: Connection diagram

- ① Input
- ② Modem
- ③ R_{Load} , $R \geq 250 \Omega$
- ④ Voltage supply 8,5...36 VDC and output 4...20 mA

The HART[®] modem is connected parallel to the output load or parallel to the output of the transmitter.

The load must be at least 250 Ω for HART[®] to work.

4.7 Connection diagram of rail-mount transmitter (intrinsically safe)

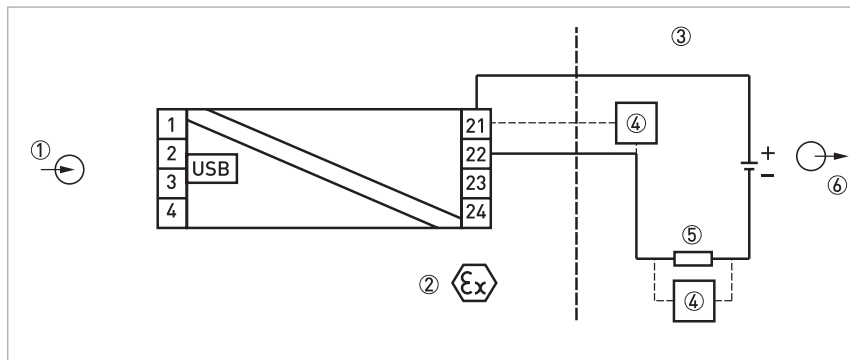

Figure 4-4: Connection diagram

- ① Input (intrinsically safe)
- ② Classified hazardous area (potentially explosive area e.g. zone 0, 1 or 2)
- ③ Safe area
- ④ HART Modem / Ex (intrinsically safe)
- ⑤ R_{Load} (intrinsically safe)
- ⑥ Voltage supply 8,5...30 VDC and output 4...20 mA (intrinsically safe - terminals 21, 22)

4.8 Cable length

In order to ensure reliable HART® communication, the maximum cable length of the output circuit must be observed.

To calculate the maximum cable length for the output circuit, determine the total resistance of the output loop (load resistance + approximate cable resistance). Find out the capacitance of the cable being used. In the following tables you can find the maximum cable length based on the typical values for 1 mm² cables. CN is the abbreviation for "Capacitance Number" which is multiple of 5000 pF present in the device.

Field device	Cable insulation					
	PVC		Polyethylene		Polyethylene foam	
	[m]	[ft]	[m]	[ft]	[m]	[ft]
1 (CN = 1)	600	1969	1100	3609	2000	6562
10 Multidrop (CN = 1)	500	1640	900	2953	1600	5249
10 Multidrop (CN = 4.4)	85	279	150	492	250	820

Table 4-1: Maximum length for typical 1 mm² cables

Insulation	Capacitance [pF/m]
PVC	300...400
Polyethylene	150...200
Polyethylene foam	75...100

Conductors			Resistance [Ω/km] (both conductors in series)
Area [mm ²]	Diameter [mm]	AWG	
2.0	1.6	14	17
1.3	1.3	16	28
1.0	1.15	17	36
0.8	1.0	18	45
0.5	0.8	20	70
0.3	0.6	22	110
0.2	0.5	24	160

Table 4-2: Cable parameters

For multiple connections (Multidrop mode), the following formula shall be used:

$$L = [(65 \times 10^6) / (R \times C)] \times (C_n \times 5000 + 10000) / C$$

with

L: cable length [m or ft]

R: load resistance (incl. the resistance of any Zener barrier) + cable resistance [Ω]

C: cable capacitance [pF/m or pF/ft]

C_n: number of transmitters in the loop

5.1 Order code

The characters of the order code highlighted in light grey describe the standard.

VTT1	4	Design
	1	Head mounting (type C)
	2	DIN-rail mounting, 35 mm / 1.38" (type R)
		Type
	M	530; digital, HART®; 4...20 mA
		Approvals
	0	Without
	1	ATEX: II 1G Ex ia IIC T4-T6
	2	IECEX: Ex ia IIC T6...T4 Ga
		Sensor
	0	Without
	1	Pt 10
	2	Pt 50
	3	Pt100 ($\alpha = 0.00385$)
	4	Pt100 ($\alpha = 0.003902$)
	5	Pt100 ($\alpha = 0.003916$)
	8	Pt1000 ($\alpha = 0.00385$)
	A	Potentiometer
	B	Thermocouple type B
	C	Thermocouple type C
	E	Thermocouple type E
	H	Thermocouple type J
	K	Thermocouple type K
	L	Thermocouple type L
	N	Thermocouple type N
	R	Thermocouple type R
	S	Thermocouple type S
	T	Thermocouple type T
	U	Cu 10
	V	Ni 50
	W	Ni 100
	X	Ni 120
	Y	Ni 1000
	Z	Customized
VTT1	4	Continued on next page









Inor Process AB

PO Box 9125

SE-200 39 Malmö

Sweden

Phone: +46-(0)40-312 560

Fax: +46-(0)40-312 570

E-mail: support@inor.se

Subsidiaries

Inor Transmitter Oy

Unikkotie 13

FI-01300 Vantaa

Finland

Phone: +358-(0)10-4217900

Fax: +358-(0)10-4217901

E-mail: myynti@inor.fi

Web: www.krohne-inor.fi

Inor Transmitter GmbH

Am See 24

D-47279 Duisburg

Germany

Phone: +49-(0)203 7382 762 0

Fax: +49-(0)203 7382 762 2

E-mail: info@inor-gmbh.de

Web: www.inor-gmbh.de

Inor North America

7 Dearborn Road

Peabody, MA 01960

United States

Phone: +1 978 826 6900

Fax: +1 978 535 1720

E-mail: inor-info@krohne.com

Web: www.inor.com

The current list of all INOR contacts and addresses can be found at:
www.inor.com