

HIOKI

3283-20

Instruction Manual

CLAMP ON LEAK HiTESTER



EN

Dec. 2018 Revised edition 1
3283C981-01 18-12H



Contents

| | |
|---|-----------|
| Introduction..... | 1 |
| Checking Package Contents | 1 |
| Safety Information | 2 |
| Operating Precautions | 7 |
| 1 Overview | 11 |
| 1.1 Overview and Features | 11 |
| 1.2 Parts and Functions..... | 13 |
| 1.3 Liquid Crystal Display | 15 |
| 2 Pre-measurement Preparation | 19 |
| 2.1 Flow of Measurement | 19 |
| 2.2 Installing/Replacing the Battery | 20 |
| 2.3 Inspection Prior to Use..... | 23 |
| 2.4 Attaching the Hand Strap | 24 |
| 3 Performing Measurements | 25 |
| 3.1 Measuring Leakage Current..... | 25 |
| Locating an insulation failure | 28 |
| Selecting the measurement range..... | 29 |
| Setting a slower display update rate (SLOW)..... | 30 |
| Setting a faster display update rate (FAST)..... | 30 |
| Measuring an intensely fluctuating load current | 31 |
| Obtaining bar graph displays (BAR GRAPH) | 32 |
| Displaying the frequency (Hz)..... | 33 |
| Measuring load current..... | 34 |
| 3.2 Reducing Noise (Filter Function – FILTER)..... | 35 |
| 3.3 Hold Data (Data Hold Function – HOLD)..... | 36 |

Contents

| | | |
|----------|---|-----------|
| 3.4 | Checking Maximum, Minimum and Average Values (Recording Function – REC)..... | 37 |
| | Bar graph displays (BAR GRAPH) | 39 |
| 3.5 | Limiting Battery's Power Consumption (Auto power-off function – APS)..... | 41 |
| 3.6 | Disabling the Buzzer..... | 42 |
| 4 | Specifications | 43 |
| 4.1 | Measurement Specifications..... | 43 |
| | AC current: Amperes rms (display of true rms)..... | 44 |
| | Frequency Hz | 45 |
| 4.2 | General Specifications | 45 |
| 5 | Maintenance and Servicing | 49 |
| 5.1 | Repair, Inspection and Cleaning..... | 49 |
| 5.2 | Troubleshooting | 51 |
| 5.3 | Error Displays..... | 52 |
| 5.4 | Message Displays | 52 |

Introduction

Thank you for choosing the Hioki 3283-20 Clamp On Leak HiTester. To ensure that your instrument performs as designed over the long term, please handle this instruction manual carefully and keep it handy for future reference.

Checking Package Contents

Once you have received the instrument, verify that it has not suffered any damage during shipment before using it. If you discover any damage or find that the instrument does not operate as stipulated in its specifications, please contact your authorized Hioki distributor or reseller.

Verify that the packaging includes all contents.

3283-20

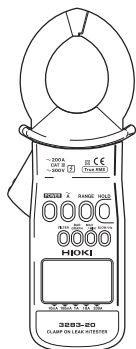

9399 Carrying Case

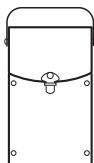

Hand Strap



6LR61 Alkaline Battery
x 1



Instruction Manual



Safety Information

The 3283-20 has been designed and tested in accordance with the IEC 61010 safety standard and shipped in a safe state. However, failure to adhere to the precautionary information and follow the instructions provided in this manual may render safety-related functionality provided by the instrument inoperable.

Before using the instrument, be sure to carefully read the following safety information.

DANGER



Improper use of the instrument may result in bodily injury or equipment damage. Read this instruction manual carefully and ensure that you understand its contents before operating the instrument.

WARNING



Electricity poses a number of hazards, including electric shock, overheating, fire, and arc discharge (caused by a short). Individuals using an electrical measuring instrument for the first time should be supervised by a technician who has experience in electrical measurement.

Protective gear





WARNING



To avoid electric shock when measuring live lines, wear appropriate protective insulation gear and adhere to applicable laws and regulations.





Safety-related notations

This manual classifies safety information on the basis of the severity of the associated risk and hazard level using the following categories.

| | |
|--|--|
|  DANGER | Indicates an imminent hazard that could lead to serious injury or death. |
|  WARNING | Indicates a hazard that could lead to serious injury or death. |
|  CAUTION | Indicates a hazard that could lead to minor injury or that could be expected to result in equipment or other damage. |
| IMPORTANT | Indicates information or content that is especially important to keep in mind when operating the instrument or performing maintenance work. |
|  | Indicates a high-voltage hazard. Warns that failure to verify safety or improper use of the instrument could lead to electric shock, burns, or death. |
|  | Indicates an action that you must refrain from performing. |
|  | Indicates an action that you must perform. |
| * | Indicates that there is additional information below. |

Safety Information

Symbols displayed on the instrument

| | |
|---|---|
|  | Indicates the need for caution or a hazard. When this symbol is displayed on the instrument, refer to the corresponding section of the instruction manual. |
|  | Indicates AC (Alternating Current). |
|  | Indicates DC (Direct Current). |
|  | Indicates that the instrument may be connected to or disconnected from a live circuit. |
|  | Indicates a double/reinforced-insulated device. |

Symbols related to standards

| | |
|---|---|
|  | Indicates the Waste Electrical and Electronic Equipment Directive (WEEE Directive) in EU member states. |
|  | Indicates that the product conforms to regulations set out by the EC Directive. |

Screen display

This instrument uses the following screen displays.

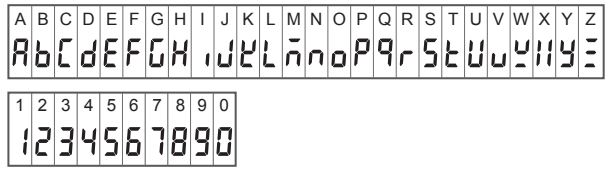

A different display is used in the case below.

OL. Over-range indication (p.17).

Other notations

| | |
|-----------------------|---|
| HOLD (Bold) | Bold text is used to indicate language used on keys and other controls. |
| [] | Language from the screen is enclosed in brackets ([]). |

Accuracy

We define measurement tolerances in terms of rdg. (reading) and dgt. (digit) values, with the following meanings:

| | |
|-------------|--|
| rdg. | (Reading or displayed value) The value currently being measured and indicated on the measuring instrument. |
| dgt. | (Resolution) The smallest displayable unit on a digital measuring instrument, i.e., the input value that causes the digital display to show a "1" as the least-significant digit. |

Safety Information

Measurement categories

To ensure safe operation of measurement instruments, IEC 61010 establishes safety standards for various electrical environments, categorized as CAT II to CAT IV, and called measurement categories.

DANGER



- **Never use a measuring instrument whose measurement category is lower than the location in which it will be used. Doing so may result in a serious accident.**
- **Never use a measuring instrument with no category labeling in a CAT II to CAT IV measurement category. Doing so may result in a serious accident.**

The 3283-20 conforms to the safety requirements for CAT III (300 V) measuring instruments.

CAT II : When directly measuring the electrical outlet receptacles of the primary electrical circuits in equipment connected to an AC electrical outlet by a power cord (portable tools, household appliances, etc.)

CAT III : When measuring the primary electrical circuits of heavy equipment (fixed installations) connected directly to the distribution panel, and feeders from the distribution panel to outlets

CAT IV : When measuring the circuit from the service drop to the service entrance, and to the power meter and primary overcurrent protection device (distribution panel)

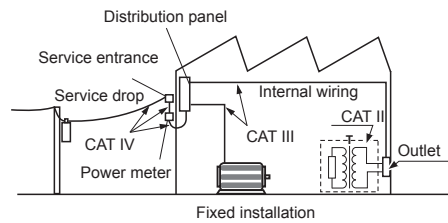

Operating Precautions

Please read the following precautions to ensure that you can use the instrument safely and fully utilize its functionality.

Checking the instrument before use

Verify that the instrument operates normally to ensure that no damage occurred during storage or shipping. If you find any damage, contact your authorized Hioki distributor or reseller.

Installation

WARNING



Installing the instrument in inappropriate locations may cause a malfunction of instrument or may give rise to an accident. Avoid the following locations.



- Exposed to direct sunlight or high temperature
- Exposed to corrosive or combustible gases
- Exposed to a strong electromagnetic field or electrostatic charge
- Near induction heating systems (such as high-frequency induction heating systems and IH cooking equipment)
- Susceptible to mechanical vibrations
- Exposed to water, oil, chemicals, or solvents
- Exposed to high humidity or condensation
- Exposed to high quantities of dust particles

Handling of the instrument

DANGER

-  Do not input a voltage or current in excess of the ratings indicated on instrument labeling or the measurement range listed in the specifications. Doing so may cause damage to, or heating of, the instrument, leading to bodily injury.
 -  The maximum measurement current varies with the frequency, and the current that can be measured continuously is limited. Operating the instrument at less than this limitation is referred to as derating. Do not measure currents in excess of the derating curve. Doing so may result in instrument damage or malfunction, fire, or burns due to sensor heating.
-
- To avoid short circuits and potentially life-threatening hazards, never attach the clamp to a circuit that operates at more than 300 V AC rms.
 -  Be sure to connect the instrument to the secondary side of circuit breakers. In the event of a short, this side of the circuit breaker will be protected from any short-circuit current by the breaker. The primary side of circuit breakers is characterized by high current capacity, and any short-circuit could result in damage to the instrument or other equipment.

WARNING

-  To avoid electric shock, do not approach high-voltage equipment or wiring when taking measurements using a transformer's ground wire. If measurement is difficult because the ground wire is located close to an exposed high-voltage conductor, reroute the ground wire before measurement.

 **CAUTION**

- Be careful to avoid dropping the instrument or otherwise subjecting them to mechanical shock, which could damage the mating surfaces of the jaw and adversely affect measurement.
-  Do not place foreign objects between the mating faces of the jaw or insert foreign objects into the gaps of the jaw. Doing so may worsen the performances of the sensor or interfere with clamping action.

- It may not be possible to accurately measure electrical circuits that have a superposed DC component.
- The  indicator lights up when the remaining battery capacity is low. In this case, the instrument's accuracy is not guaranteed. Replace the battery immediately.

Precautions when transporting the instrument

When shipping the instrument, handle it with care so as to avoid damage due to vibration or mechanical shock.

1 Overview

1.1 Overview and Features

The 3283-20 is designed for wide-range measurement of current in live circuits, from very small leak currents up to load currents of 200 amperes. The jaws are made of material with high magnetic permeability to minimize adverse effects from external magnetic fields and error due to the position of the conductor measured, thus raising accuracy.

High-sensitivity ranges with 10 mA full scale

Accurate measurement even of minute leak currents (resolution 10 μ A).

Extensive measurement range

Five ranges in a 10 mA to 200 A full scale, for measurement over an extensive range.

Built-in microcomputers give multifunctionality

SLOW, **MAX** and **MIN** are just some of the functions offered by this compact, multifunctional instrument.

Displays true RMS values

Packs true-rms conversion circuits for accurate measurements unaffected by leak current distortion.

Filter functions

The widespread use of switching power supplies and equipment incorporating inverter technology can cause high-frequency

Overview and Features

components to be superimposed on leak current waveforms. The filter functions allow measurement of two kinds of leak current: the kind caused by insulation faults and the kind that contains high-frequency components.

Minimized effects from external magnetic fields and conductor position

The jaws are made of material with high magnetic permeability, allowing precise measurement near to transformers, electric motors and other sources of magnetic fields. And error due to conductor cable position is extremely low, so that even if the instrument is used as a residual current transformer, the residual current characteristics are low and measurement accuracy is good.

Low power consumption

Rated power: 100 mVA
Approximately 40 hours of continuous operation on single layered-type manganese dry cell battery (6F22)

1.2 Parts and Functions



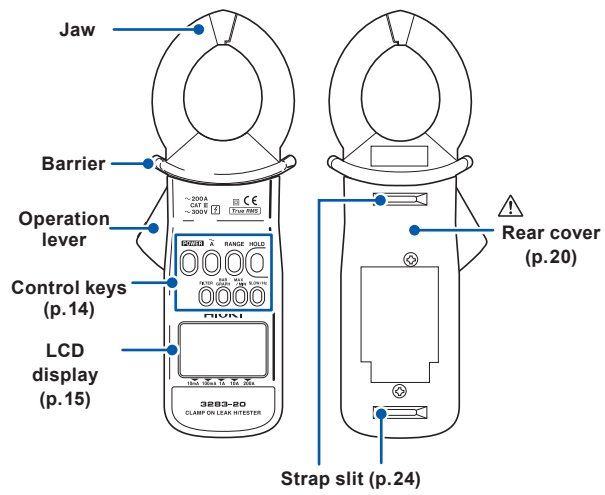



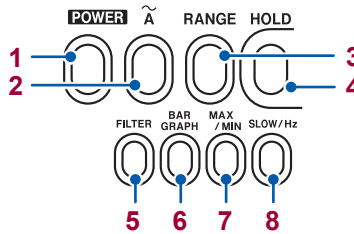

Front and rear



Parts and Functions

Control keys



| | Key | Normally | Power turned on while holding key down |
|----------|--|---|--|
| 1 |  POWER key | Turns the power on/off | – |
| 2 |  A key | Turns the recording function off (p.38) | – |
| 3 |  RANGE key | Switches the range (p.29) | Disables the buzzer (p.42) |
| 4 |  HOLD key | Turns the data hold function on/off (p.36) | Cancels the auto power-off (APS) function (p.41) |
| 5 |  FILTER key | Turns the filter function on/off (p.35) | – |
| 6 |  BAR GRAPH key | Switches the bar graph display (p.32) | – |
| 7 |  MAX/MIN key | Turns the recording function on (p.37) | – |
| 8 |  SLOW/Hz key | <ul style="list-style-type: none"> Setting a slower display update rate (p.30) Freq. measurement (p.33) | – |

1.3 Liquid Crystal Display

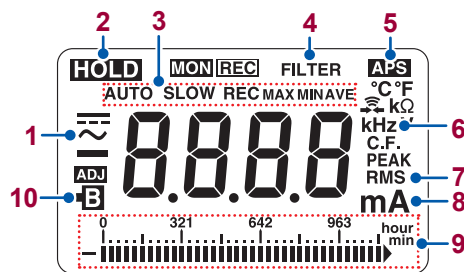

| | | |
|-----------|---------------|--|
| 1 | ~ | AC measurement (p.25) |
| 2 | HOLD | Hold data (p.36) |
| 3 | AUTO | Auto ranging is enabled (p.29) |
| | SLOW | Update display approx. 1 time/3 seconds (p.30) |
| | REC | Recording function is on (p.37) |
| | MAX | Maximum value (p.37) |
| | MIN | Minimum value (p.37) |
| 3 | AVE | Average value = (maximum value + minimum value)/2 (p.37) |
| | FILTER | Filter function is enabled (p.35) |
| 5 | APS | Auto power-off function is enabled (p.41) |
| 6 | Hz | Frequency (p.33) |
| 7 | RMS | True root-mean-square value (p.26) |
| 8 | mA | Current (A, mA) |
| | hour | 1 hour/segment (bar graph) |
| 9 | min | 1 minute/segment (bar graph) |
| | ▶ | Over-range indication (bar graph) |
| 10 | B | Battery depleted (p.16) |

Liquid Crystal Display

Battery remaining power display

When the power is turned on, all the LCD's segments light up. Then the model name is displayed, and the bar graph shows the battery power for 1 second.

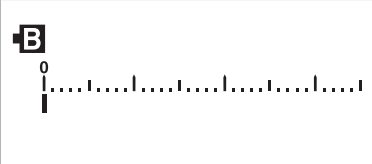
| | |
|---|--|
|  | Bar graph display with fresh battery |
|  | If the battery remaining power is zero, B will light up and the buzzer will sound three beeps. When B is lighted, the instrument's accuracy cannot be assured. |

Power shut-off



When the battery voltage drops below a certain level after **B** lights, the power will be shut off automatically to protect the internal memory. **[bAtt]** and **[Lo]** will be displayed to indicate this.



When these are displayed and the power has been shut off, replace the exhausted battery with a new one.

Over-range indication



[O.L.] will be displayed if the measured current or frequency is beyond the measurement limit. When this display occurs, select an appropriate range.

2 Pre-measurement Preparation

2.1 Flow of Measurement

Before using the instrument, be sure to read "Operating Precautions" (p.7)

Preparing and connecting-up

Install the battery (p.20).



Do pre-use checks (p.23).



(As necessary)
Attach the hand strap (p.24).



Measuring

Turn the power on.



Clamp the conductor to be measured.



(As necessary)
Select the measurement range (p.29).
Reduce noise (p.35).



Ending

Turn the power off.

2.2 Installing/Replacing the Battery

Before using the instrument for the first time, install a layered-type alkaline battery (6LR61) or a layered-type manganese dry cell battery (6F22). Also, before doing measurement, check that there is adequate remaining power in the battery. If there is not, replace the battery.

WARNING



- **Battery may explode if mistreated. Do not short circuit, recharge, disassemble or dispose of in fire.**



- **To avoid electric shock, remove the jaws from the object to be measured, and remove the rear cover, before replacing the battery.**
- **Also, before using the instrument after replacing the battery, fasten the rear cover with its screws.**
- **To avoid damage to the instrument or electric shock accidents, use only the screws that came with the instrument to fasten the rear cover in place. If you lose or damage the screws, contact your authorized Hioki distributor or reseller.**
- **Handle and dispose of batteries in accordance with local regulations.**

 **CAUTION**

Heed the following instructions to avoid battery performance drop or leakage.

- Pay attention to the polarity markings "+" and "-", so that you do not insert the battery the wrong way around.
- Do not use a battery beyond its recommended use period.
- Do not leave a depleted battery inside the instrument.
- Be sure to replace it with a battery of the specified type.
- Remove the battery and store it if the instrument will not be in use for a long time.



To avoid damage to the instrument, do not screw the rear cover screws in too tightly. Torque of about 0.5 N•m is recommended.

- When **B** appears, the battery is exhausted and accuracy is not assured. Replace the battery as early as possible.
- Turn the power off before replacing the battery.
- When installing the new battery, make sure that the battery snaps are securely connected to it. If a snap is loose, adjust it so that it is securely connected. If the battery isn't securely connected, the power may not come on or may turn off during use.

Installing/Replacing the Battery

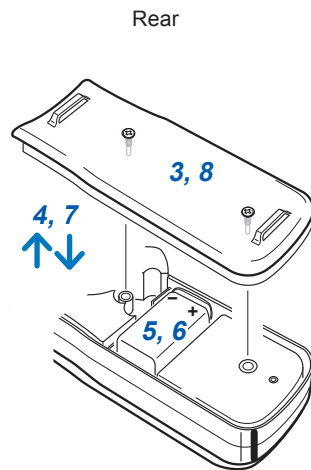

- 1 Prepare the following:**
 - A layered-type alkaline battery (6LR61) or a layered-type manganese dry cell battery (6F22)
 - Phillips screwdriver
- 2 Turn the instrument's power off.**
- 3 Loosen the rear cover's two fastening screws, using the Phillips screwdriver.**
- 4 Remove the rear cover.**
- 5 Remove the old battery, taking care not to pull on the battery snap cords.**
- 6 Firmly install the new battery to the battery snaps. Be sure to orient the polarity correctly.**
- 7 Fasten the rear cover.**
- 8 Screw in the fastening screws to fasten the rear cover.**

2.3 Inspection Prior to Use

Before using the instrument for the first time, inspect it carefully to ensure that no damage occurred during shipping. If damage is evident, or if it fails to operate according to the specifications, contact your dealer or Hioki representative.

Exterior appearance check

| Check item | Action |
|--|--|
| <ul style="list-style-type: none"> Any breakage or cracks in the instrument's exterior? Any internal circuits exposed? | Check visually. If there is any of this damage, the instrument will not measure correctly. Do not use the instrument in this condition. Have it repaired first. |

Checks when turning on the power

| Check item | Action |
|-------------------------------------|---|
| Sufficient battery power remaining? | If the B in the left side of the LCD display lights or if the power is shut off soon after being turned on, measurement accuracy cannot be assured and you must immediately replace the battery with a new one (p.20). |
| All LCD segments are displayed? | Check that all of the LCD's segments light up (p.15). If any of the segments does not light, you must have the instrument repaired. |

Attaching the Hand Strap

2.4 Attaching the Hand Strap

Strap slits on the back of the instrument can be used for attaching the included hand strap. Use the hand strap to help prevent accidental dropping of the instrument.

CAUTION



Attach the strap securely, by inserting it through the strap slits on the instrument. If the strap is not securely attached, the instrument may fall and be damaged.

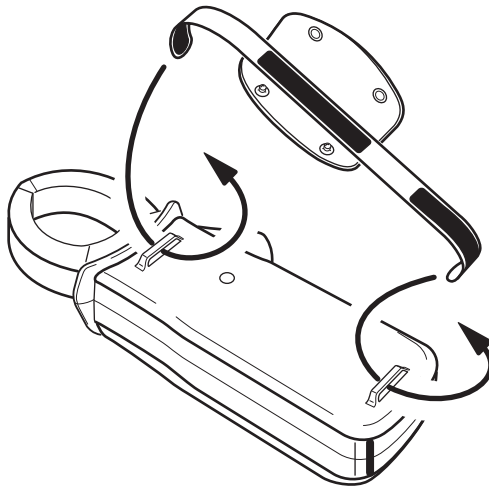

3 Performing Measurements

3.1 Measuring Leakage Current

! DANGER

⊘ To prevent electric shock, do not touch any part beyond the barrier during use (p. 13).

1



2 Clamp the conductor at the center of the jaw.

To measure the ground wire of a circuit, clamp the ground wire only. (See 1 in the figure)
To measure all the wires of a circuit, clamp them all together in a bundle. (See 2 in the figure)

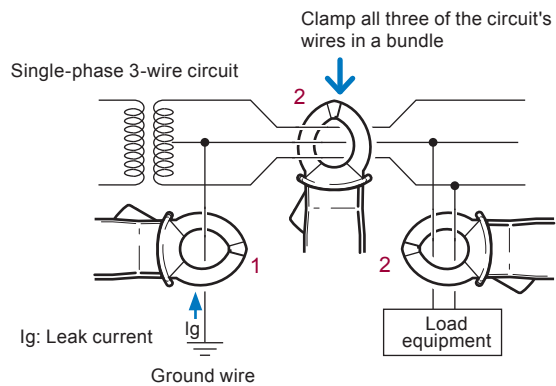

25

Measuring Leakage Current

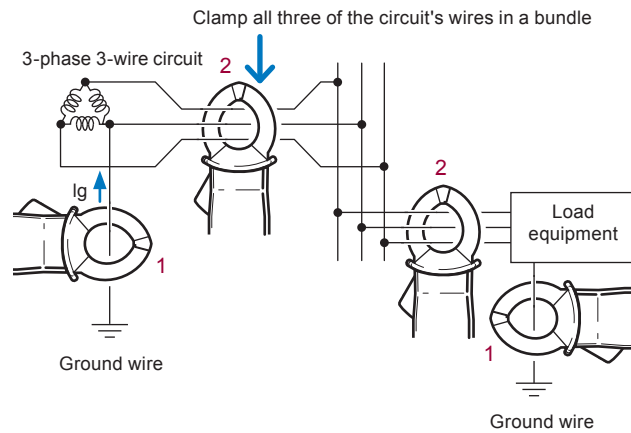

- To measure a single-phase 2-wire circuit, clamp both of the circuit's wires together.
- To measure a 3-phase 3-wire circuit, clamp all 3 of the circuit's wires bundled together.
- To measure a 3-phase 4-wire circuit, clamp all 4 of the circuit's wires bundled together. If that is not possible, carry out the measurement on the equipment's ground wire.



The effective value (RMS) of the leak current will be shown on the digital display.

- Do not input current that exceeds the current range's maximum continuous input.
- Measurement may not be accurate in the cases below.
 - (1) If there is large current (of about 100 A) flowing through a nearby electric line.
 - (2) If you use the instrument to measure the waveforms on the secondary side of an inverter, or other special waveforms.
 - (3) If the jaws are not fully closed.

In cases where the wires are thick, such as with clamping of a 3-phase cable, always make sure that the jaws are fully closed. When the jaws are not fully closed, error occurs in the measured values and accuracy cannot be assured.
- Note that a value of several tens of amperes may be displayed when the jaws are opened or closed or when the current range is changed, but this is not an error. Simply wait a little while for the display to return to zero. Or start measurement before it returns to zero – there will not be any adverse effects.
- In cold areas, the display may not go to zero when the jaws are taken off the conductor. This will not affect accuracy, provided that you are measuring current of or above the 1 mA that is the bottom limit of the guaranteed accuracy range.
- This instrument is designed for measuring electricity lines up to CAT III 300 V (voltage to ground). However, in the exceptional case of a 3-phase 3- or 4-wire line, or similar line, whose neutral point is grounded ("Y" connection or star connection), the instrument can be used on lines of up to 500 V line voltage (approx. 289 V voltage to ground) – but only in such a case.

Locating an insulation failure

For a transformer, first measure the ground wire to determine the overall circuit leak current (see 1 in the figure), then use the variation in the leak current to diagnose the presence or absence of leakage.

If you diagnose leakage to be present, use bundled measurement of all the wires to locate it. Start from the power source and work toward the load.

- Suppose an insulation fault in the wiring has occurred at (1) in the figure. It will be possible to detect the leak current with bundled measurement at position 2, but not at 2'.
- Suppose an insulation fault in the load equipment has occurred at (2) in the figure. It will be possible to detect the leak current with bundled measurement at position 3, but not at 3'.
- To detect intermittent leak current (occurring only when a certain piece of equipment is operating), the use of a memory recorder will be helpful.

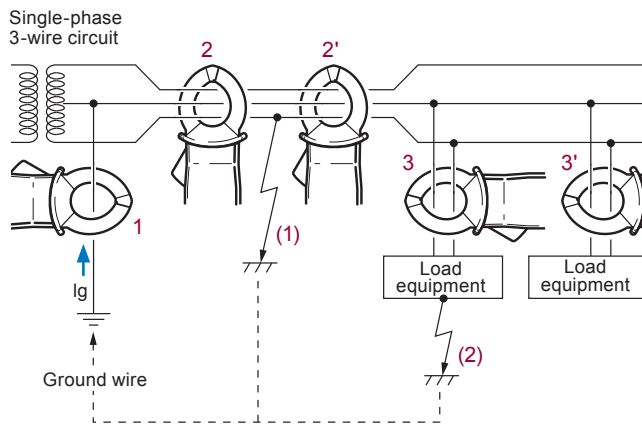

Selecting the measurement range

You can set auto or manual ranging.

- Auto ranging The optimal range for the measured values is set automatically.
- Manual ranging Setting is fixed to a particular range.

With the frequency display, only auto ranging is available.

Auto ranging



Measurement will begin with auto ranging when the power is turned on.

[AUTO] lights up (initial setting)

Manual ranging

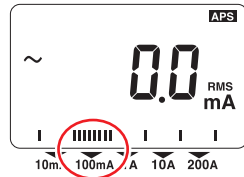

Bars will appear above the currently selected range. The figure above shows the 100 mA range selected.

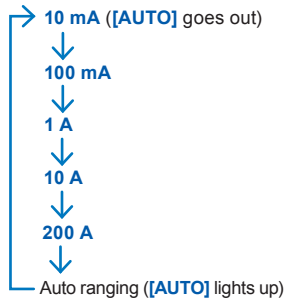

Setting a slower display update rate (SLOW)

If the displayed current value fluctuates rapidly and is hard to read, you can set a slower update rate (approx. 1 time/3 seconds) by pressing the SLOW/Hz key, to make the value easier to read.

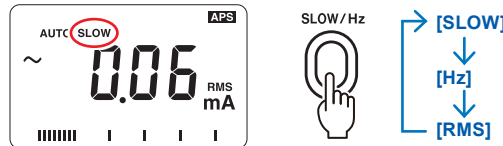

- Setting [Hz] or [RMS] will return the display to the normal update rate.
- With the frequency display, the update rate cannot be changed.

Setting a faster display update rate (FAST)

A faster rate of approximately 4 times per second can be set for the display update. This is useful for example to measure load currents with intense fluctuations and in similar applications.

NORMAL



FAST (Split-second display each time \tilde{A} key is pressed)

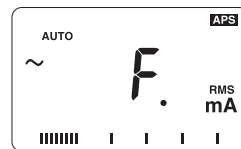

If you switch to [SLOW] display while the instrument is in the fast mode, the display update rate will be the same as [NORMAL] (approx. 2 times/second).

Measuring an intensely fluctuating load current

First set the FAST display update rate and set the appropriate range using the **RANGE** key. Then do the measurement.

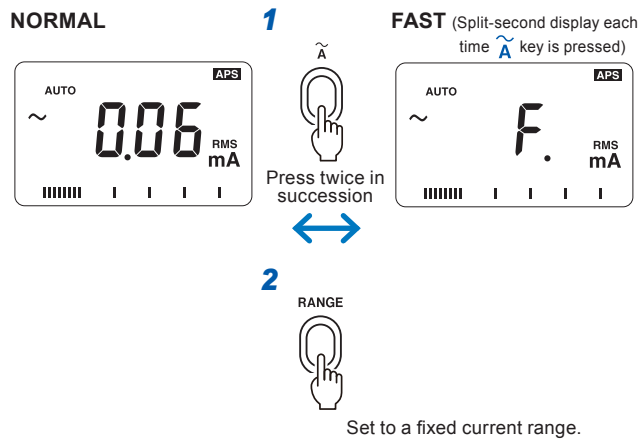

- If you don't know the magnitude of the current to be measured, select the 200 A range.
- Using the recording function to retain the maximum value will make it easier to take readings (p. 37).

Measuring Leakage Current

Obtaining bar graph displays (BAR GRAPH)

You can have the current range displayed as a bar graph. The bar graph will show the rms value of the measured current. The bar graph display update rate will be FAST (approx. 4 times/second).

Current range display



BAR GRAPH



Bar-graph display

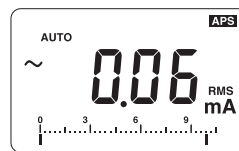

The flashing segment in the bar graph indicates the full-scale position.

Displaying the frequency (Hz)



When **[SLOW]** is displayed:

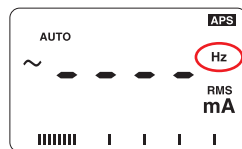
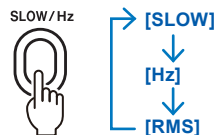

The frequency of the current being measured will be displayed.

If there is no input, or input is lower than 30 Hz, "-----" will be displayed.

- Enable the filter function when conducting measurement in the cases below (p.35).
 - (1) If meaningless data is displayed due to noise.
 - (2) If you use the instrument to measure the waveforms on the secondary side of an inverter, or other special waveforms.
- The instrument may not be able to perform measurement in the cases below.
 - (1) If the input current is 1/10 or less of the current range (full-scale).
 - (2) If you measure high frequencies with the filter function enabled.
- The frequency range is set automatically. If you press the **RANGE** key, only the current range will be changed.

Measuring load current

To measure load current, clamp just one wire of the conductor. The measurement will not be possible if you clamp both wires of a single-phase cable or all 3 wires of a 3-phase cable.

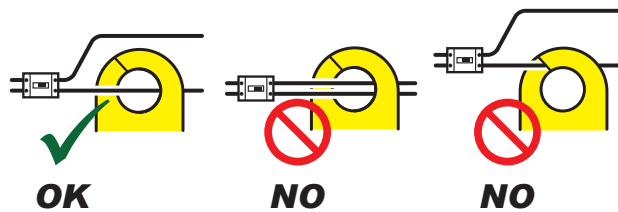

- The instrument may not be able to measure certain special waveforms, for example on the secondary side of an inverter.
- Depending on the magnitude and frequency of the input current, resonance may cause the jaws to emit noises, but this will not affect the measurement.
- If you don't know the magnitude of input current, disable the filter function and begin measurement with auto ranging or with the 200 A range set.

3.2 Reducing Noise (Filter Function – FILTER)

The widespread use of switching power supplies and equipment incorporating inverter technology can cause high-frequency components to be superimposed on leak current waveforms. Use the filter function to eliminate unwanted high-frequency components.

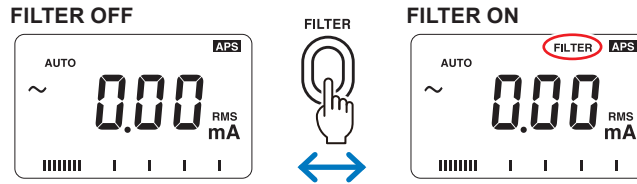

The frequency bandwidth with the filter function enabled is limited to approximately 180 Hz (-3 dB), comparable to the frequency bandwidth for an ordinary leakage breaker. It is recommended that the filter function be used when analyzing leakage breaker operation.

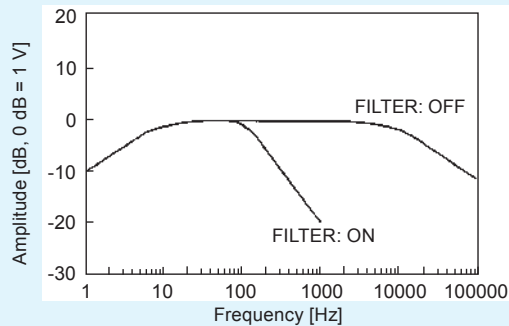

Frequency bandwidths (with 10 mA current range used)

Hold Data (Data Hold Function – HOLD)

3.3 Hold Data (Data Hold Function – HOLD)

Use this to freeze the displayed data (put it on hold) for easy reading.

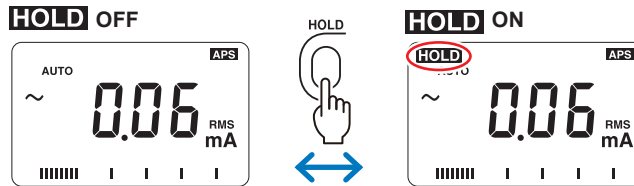

3.4 Checking Maximum, Minimum and Average Values (Recording Function – REC)

Use the recording function to display the maximum/minimum measurement value, the average of the maximum and minimum, or the instantaneous value.

1 RANGE
Select the current range.

2 MAX / MIN
Press the **MAX/MIN** key while current is being measured.

The maximum, minimum, average or instantaneous value for the period from when the **MAX/MIN** key was last pressed up to the present moment will be displayed. The other data will be retained in the internal memory. ([REC] will flash)

| [MAX], [MIN] and [AVE] displays | Measurement value displayed |
|---------------------------------|---|
| [MAX] | Maximum value |
| [MIN] | Minimum value |
| [AVE] | Average value = (maximum value + minimum value)/2 |
| None | Instantaneous value |

- Pressing the **MAX/MIN** key during auto ranging ([AUTO]) fixes the range at the current setting.
- When you use the recording function, auto power-off will be turned off automatically.

Checking Maximum, Minimum and Average Values (Recording Function – REC)



3



Halt the recording function.

(**HOLD** lights, **[REC]** lights up)

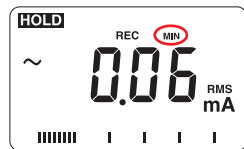

4



Maximum value **[MAX]**
↓
Minimum value **[MIN]**
↓
Average value **[AVE]**
↓
Instantaneous value

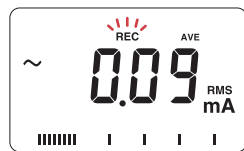

5



Turn the recording function back on.

(**HOLD** goes out, **[REC]** flashes)

Turning the recording function off



The maximum, minimum or average value will be cleared. (**[REC]** will go out)

- The elapsed time count will stop for as long as **HOLD** lights steady.
- Momentary power loss and power surges cannot be detected in this mode.
- The maximum, minimum or average value will be cleared when the power is turned off.
- The duration that the recording function can be used for depends on the remaining battery capacity. Use a new layered-type alkaline battery (6LR61) when using it for a long duration.
- The lowest frequency that can be displayed is 30.0 Hz.
- If you clamp the conductor after enabling the recording function, there will be no input and so the minimum value will be zero. To prevent this, clamp the conductor before pressing the **MAX/MIN** key to enable the recording function.
- If you take the jaws off the conductor with the recording function still enabled, the input will stop and so the minimum value will be zero. To prevent this, press the **HOLD** key to halt the recording function before taking the jaws off the object.

Bar graph displays (BAR GRAPH)

You can switch the bar graph between different displays.

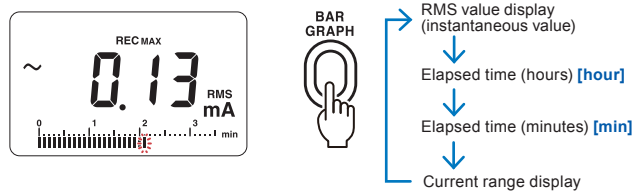

When you set one of the elapsed time displays, a segment in the bar graph will flash to indicate the time that has elapsed since the **MAX/MIN** key was last pressed.

When [min] is displayed at the right end of the bar graph:

1 segment in the bar graph represents 1 minute. The segment for the currently elapsing minute flashes, and when the minute has elapsed, that segment stops flashing and lights steady. The segments do this one after the other, starting from the left end of the graph and going rightward. When all the bar graph's segments are lighted steady, 30 minutes have elapsed. From then on, the segments will once more flash one by one from left to right, to indicate the elapsing minute, but this time the flashing segment will go out with each minute that elapses.

When the segments to the left of the flashing segment are lighted steady:

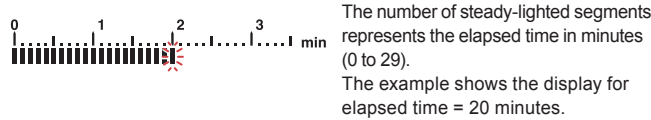

When the segments to the right of the flashing segment are lighted steady:

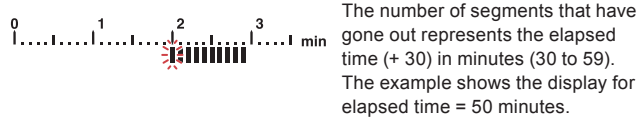

When [hour] is displayed at the right end of the bar graph:

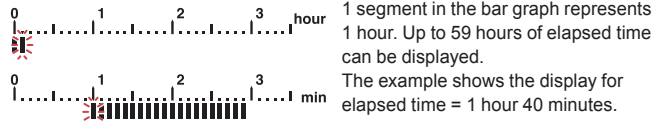

3.5 Limiting Battery's Power Consumption (Auto power-off function – APS)

Use this to limit the battery's power consumption. It turns the power off automatically if the instrument is not operated for 10 minutes. The APS function is configured at the factory to enabled (this is the initial setting). (**APS** lights up)

When APS is enabled, **APS** on the LCD display will flash, and a beep will sound to warn you that the instrument will automatically turn off in 30 seconds. To continue using the instrument, press any key other than the **POWER** key. But note that even so, the power will be shut off automatically after another 10 minutes if you leave the instrument unoperated for that period once more.

- When operating the instrument continuously for a long duration, disable the auto power-off function in advance.
- Using the recording function disables the APS function.

Disabling the auto power-off function

If the power is on, turn it off.

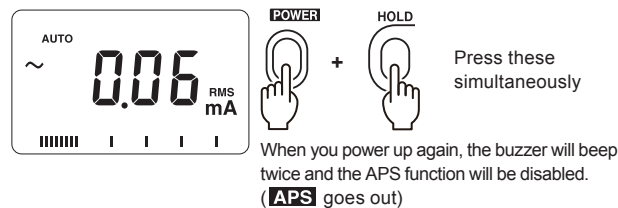

Auto power-off will be disabled up until the power is turned off. Be aware of this if the battery is low.

Disabling the Buzzer

3.6 Disabling the Buzzer

The buzzer is configured at the factory to enabled (this is the initial setting). To change this setting, first turn the power off.

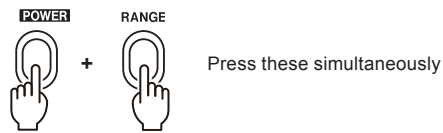

When you power up again, the buzzer will beep twice. Then it will be disabled.

The buzzer will be disabled up until the power is turned off.

4 Specifications

- rdg. (Reading or displayed value)
The value currently being measured and indicated on the measuring instrument.
- dgt. (Resolution)
The smallest displayable unit on a digital measuring instrument, i.e., the input value that causes the digital display to show a “1” as the least-significant digit.

4.1 Measurement Specifications

| | | |
|--|---|-------------------------------------|
| Conditions of guaranteed accuracy | Guaranteed accuracy period: | 1 year |
| | Guaranteed accuracy period from adjustment made by Hioki: | 1 year |
| | Number of jaw opening-closings: | Up to 10,000 |
| | Temperature and humidity for guaranteed accuracy: | 23°C±5°C (73°F±9°F), 80% RH or less |
| | Battery low indicator B must not be on. | |
| Diameter of measurable conductors | φ40 mm max. | |

Measurement Specifications

AC current: A rms (display of true rms)

| Range (accuracy range) | Resolution | Accuracy | Maximum allowable current |
|-----------------------------------|------------|---|---|
| 10.00 mA (1.00 mA to 10.00 mA) | 0.01 mA | FILTER OFF: 45 Hz to 66 Hz: ±1.0% rdg. ±5 dgt. 40 Hz to 45 Hz, 66 Hz to 2 kHz: ±2.0% rdg. ±5 dgt. | 20 A AC rms, continuous (p. 47) |
| 100.0 mA (10.0 mA to 100.0 mA) | 0.1 mA | | |
| 1.000 A (0.100 A to 1.000 A) | 0.001 A | | |
| 10.00 A (1.00 A to 10.00 A) | 0.01 A | FILTER ON: 50 Hz to 60 Hz: ±1.5% rdg. ±5 dgt. | |
| 200.0 A (10.0 A to 200.0 A) | 0.1 A | FILTER OFF: 45 Hz to 66 Hz: ±1.5% rdg. ±5 dgt. 40 Hz to 45 Hz, 66 Hz to 2 kHz: ±2.0% rdg. ±5 dgt. FILTER ON: 50 Hz to 60 Hz: ±2.0% rdg. ±5 dgt. | 200 A AC rms, continuous (p. 47) |

Effect of conductor position Within ±0.1% rdg. (with any position relative to the center of the jaw and current under 100 A)
 Within ±0.5% rdg. (with current 100 A or higher)

Effects of external magnetic fields Equivalent of 5 mA, max. 7.5 mA, with external magnetic field of 400 A/m AC

Maximum rated voltage to earth 300 V AC (Measurement Category III)
 Anticipated transient overvoltage: 4000 V

Frequency Hz

| Range (accuracy range) | Resolution | Accuracy |
|-------------------------------|------------|--------------------|
| 100.0 Hz (30.0 Hz to 99.9 Hz) | 0.1 Hz | ±0.3% rdg. ±1 dgt. |
| 1000 Hz (95 Hz to 1000 Hz) | 1 Hz | ±1.0% rdg. ±1 dgt. |

The frequency range is set automatically. If you press the **RANGE** key in the frequency display mode, only the current range will be changed.

4.2 General Specifications

Auxiliary functions

| | |
|--------------------------------------|--|
| Recording | Maximum ([MAX]), minimum ([MIN]), and average ([AVE]) value displayable for AC current and frequency measurement |
| Data hold | Puts display on hold |
| Auto power-off | Sounds intermittent beep alert and shuts off power automatically approximately 10 minutes after last key operation (Shut-off can be delayed or canceled) |
| Battery low voltage power-off | When the battery voltage falls below a certain level, this shuts the power off to prevent malfunctions |
| Beep tone | ON/OFF |

LCD display

| | |
|------------------------------|---|
| Digital indication | 2000 counts, displaying values less than or equal to 5 counts with a zero |
| Bar-graph indication | 35 segments Range display or rms display can be selected |
| Over-range indication | [O.L.] display (using 7 segments); bar-graph display ▶ |

General Specifications

| | |
|--|---|
| Battery low warning | B (This indicator lights to indicate the battery is low. When this is lighted, accuracy is not guaranteed.) |
| Battery low power-off | [bAtt] → [Lo] is displayed (using 7 segments), then power is shut off |
| Data holding indication | HOLD |
| Auto power-off indication | APS |
| Other functions | |
| Filter functions | ON: 180 Hz ±30 Hz (-3 dB) / OFF |
| Display update rate | <ul style="list-style-type: none"> • Digital indication <ul style="list-style-type: none"> NORMAL 500 ms ±25 ms (approx. 2 times/second) SLOW 3 s ± 0.15 s (approx. 1 time/3 seconds) FAST 250 ms ±12.5 ms (approx. 4 times/second) • Bar-graph indication 250 ms ±12.5 ms (approx. 4 times/second) |
| Display response time | With AC current and frequency: 2.2 seconds or less |
| Ranging | <ul style="list-style-type: none"> • For AC current: auto ranging or manual (fixed) ranging can be selected • Frequency: Auto ranging |
| Circuit dynamic characteristic (crest factor) | 2.5 max. (max. 1.5 with 200 A range) |
| Dielectric withstand voltage | Between jaws and hand-held portion: 4.29 kV AC/minute |
| Insulation resistance | Between jaws and circuitry: 630 kΩ or higher |
| Operating environment | Indoors, Pollution Degree 2, altitude up to 2000 m (6562 ft.) |

General Specifications

| | |
|---|---|
| Standards | Safety: EN61010 EMC: EN61326 |
| Dust-proof, water-proof | IP40 (EN60529) |
| Operating temperature and humidity | 0°C to 40°C (32°F to 104°F), 80% RH or less (non-condensing) |
| Temperature characteristics | In 0°C to 40°C (32°F to 104°F) range: 0.05 × accuracy specifications/°C |
| Storage temperature | -10°C to 50°C (14°F to 122°F) (non-condensing) |
| Power supply | Layered-type alkaline battery (6LR61) × 1, or layered-type manganese dry cell battery (6F22) × 1 Rated supply voltage: 9 V |
| Maximum rated power | 100 mVA |
| Continuous operating time | Approx. 40 hours (when unloaded and using a layered-type manganese battery (6F22)) |
| Dimensions | Approx. 62 mm (2.44") W × 225 mm (8.86") H × 39 mm (1.54") D |
| Mass | Approx. 400 g (14.1 oz.) (excluding battery) |
| Product warranty period | 3 years |
| Accessories | See "Checking Package Contents" (p. 1). |

Frequency-dependent derating characteristics

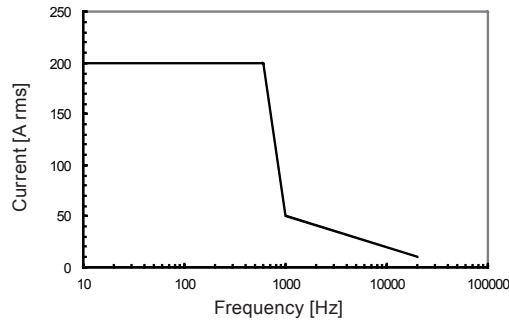

5 Maintenance and Servicing

WARNING



Touching any of the high-voltage points inside the instrument is very dangerous. Customers are not allowed to modify, disassemble, or repair the instrument. Doing so may cause fire, electric shock, or injury.

5.1 Repair, Inspection and Cleaning

Calibration of the instrument

How often you should calibrate the instrument will depend on the usage conditions and the environment. Determine a calibration interval that is suited to your usage conditions and environment, and request to have calibration done by Hioki.

Cleaning

CAUTION

If foreign matter gets jammed in the jaw tips, do not attempt to remove it by forcibly opening/closing the jaws. Remove it gently with a soft brush or similar.



Foreign matter must be removed, or measurement will not be accurate. It will also not be accurate if the jaws are deformed, by foreign matter or other cause. If the jaws become deformed, contact your authorized Hioki distributor or reseller.

- To clean the instrument, wipe it gently with a soft cloth moistened with water or neutral detergent.
- Clean the display area by wiping it gently with a soft dry cloth.

IMPORTANT

Never use solvents containing benzene, alcohol, acetone, ether, ketone, thinner, gasoline, or similar to clean the instrument. Deformation or discoloration may result.

Disposal of the instrument

Dispose of the instrument in accordance with local regulations.

5.2 Troubleshooting

If a problem occurs with the instrument, first carry out the checks in "Troubleshooting checklist" below. If the problem persists, contact your authorized Hioki distributor or reseller.

Troubleshooting checklist

| Problem | Cause | Solution |
|--|---|---|
| Power will not turn on Power shuts off during operation | The battery may be low or depleted. | Replace it with a new battery (p.20) |
| | The battery snap terminals may be stretched causing contact failure. | Remove the battery, then use radio pliers or similar to readjust the battery snap terminals. |
| | With the auto power-off function enabled, the power is shut off automatically if the instrument is not operated for 10 minutes. | Check the settings for the APS function (p. 41). |
| B lights up B lights, followed by immediate power shutdown Power turns off immediately after it is turned on | The battery may be low or depleted. | Replace it with a new battery (p.20). |
| Range cannot be changed | Recording function ([MAX]/[MIN]/[AVE] display) is operating – this renders range change impossible. | Press the  key to turn off the recording function. Then change the range (p.38). |

Error Displays

| Problem | Cause | Solution |
|--|--|--|
| Any of [E.001] to [E.004] is displayed | Internal memory may be damaged. | Have the instrument repaired (p.52) |
| The jaws generate a sound during measurement | When large current or high-frequency current is measured, resonance may occur, generating a sound. | The loudness will depend on the individual case, but the sounds will not affect the measurement. |

5.3 Error Displays

| Error display | Definition | Solution |
|---------------|---|--|
| [E. 001] | Checksum error in single-chip microcomputer's internal ROM. | If any of these errors is displayed in the LCD display area, repair is required. Contact your authorized Hioki distributor or reseller for repair. |
| [E. 002] | R/W error in single-chip microcomputer's internal RAM. | |
| [E. 003] | EEPROM checksum error. | |
| [E. 004] | | |

5.4 Message Displays

| Display | Definition | See page |
|---------|---|----------|
| bAtt | Battery depleted. Replace it with a new battery. | p.20 |
| Lo | | |

Message Displays

| Display | Definition | See page |
|---------|--|----------|
| E.OO 1 | There is abnormality in the internal ROM or EEPROM data. Have the instrument repaired. | p.52 |
| OL. | This is displayed if the measured current or frequency is beyond the measurement limit. Select an appropriate range. | - |
| - - - - | When frequency display is set, this message indicates that there is no input or that the frequency is under 30 Hz. | p.33 |