

User's Guide

Introducing the safety standards, testing methods, and appropriate test instruments for **electrical medical equipment**



Avoiding Accidental Electric Shock

1

Electronic equipment must be designed to avoid accidental electric shock. Electric shock accidents can be so severe as to cause death, fire or explosion. What is the cause of electric shock, and what can we do to prevent it?

This presentation describes tests that have been instituted to prevent electric shock.

1

Avoiding Accidental Electric Shock

HIOKI-

Cause of Electric Shock

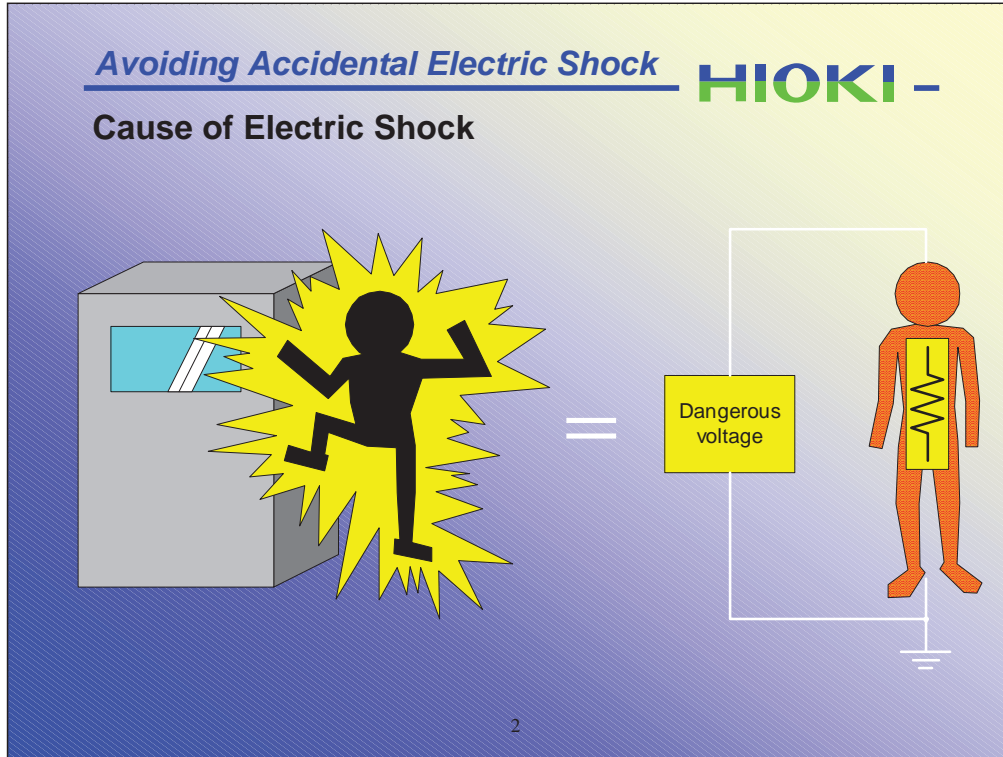

When you touch an electrical device, for example, to change a panel setting, you may suddenly experience an electric shock. Although the shock itself might not be harmful, it could cause a fire or explosion, or even loss of life.

What causes an electric shock?

It is helpful to think of the human being as an electrical impedance. A body's resistance is typically several kOhms. An electric shock occurs when electric current flows through that resistance. Notice that the person in the diagram is standing on the ground, meaning he is electrically earthed.

For an electric current to flow through the body's resistance, there must be a potential difference between ground and another point, which in this case is the voltage at the control panel of the electrical device.

Many electrical devices have dangerous voltages within, such as transformers, motors and heaters. What can be done to prevent the body from coming into contact with such dangerous voltages?

Avoiding Accidental Electric Shock **HIKI-**

Countermeasure 1: "Enclosure" = Isolation

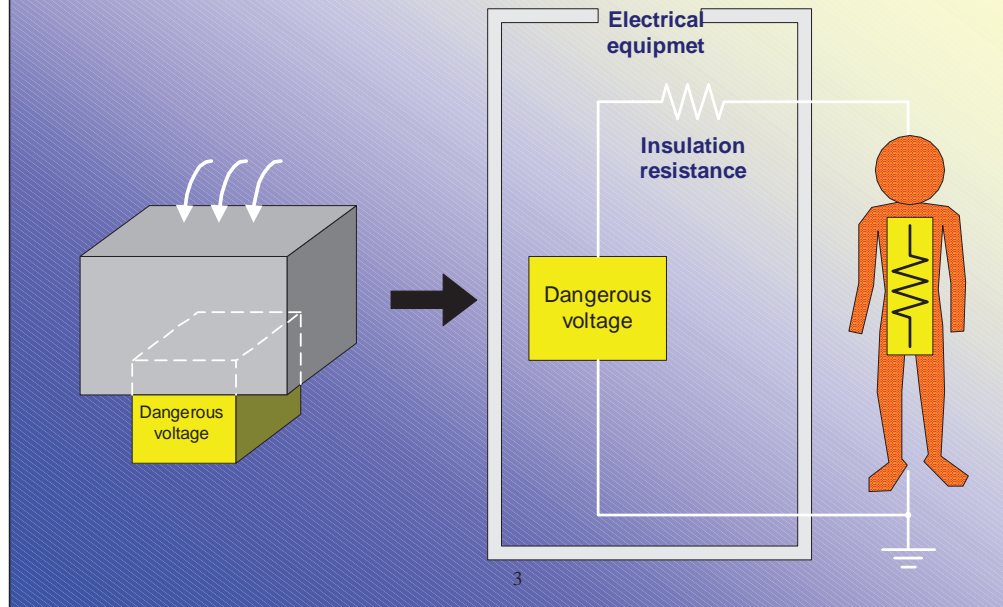

How about enclosing the dangerous voltage to prevent contact?

This countermeasure isolates the internal circuitry from the equipment enclosure. As an example, assume there is an insulation resistance between the internal circuitry and the enclosure. When a body touches the enclosure, such as at a control panel, the body's resistance and the insulation resistance are connected in series. As the body's resistance is only several kOhms relative to the many of MOhms of insulation resistance, very little electric current is allowed to flow through the body.

Safety standards that regulate the effectiveness of this countermeasure define the Withstanding Voltage test and insulation resistance test.

Avoiding Accidental Electric Shock **HIOKI-**
Countermeasure 2. : “Discharge” = Grounding

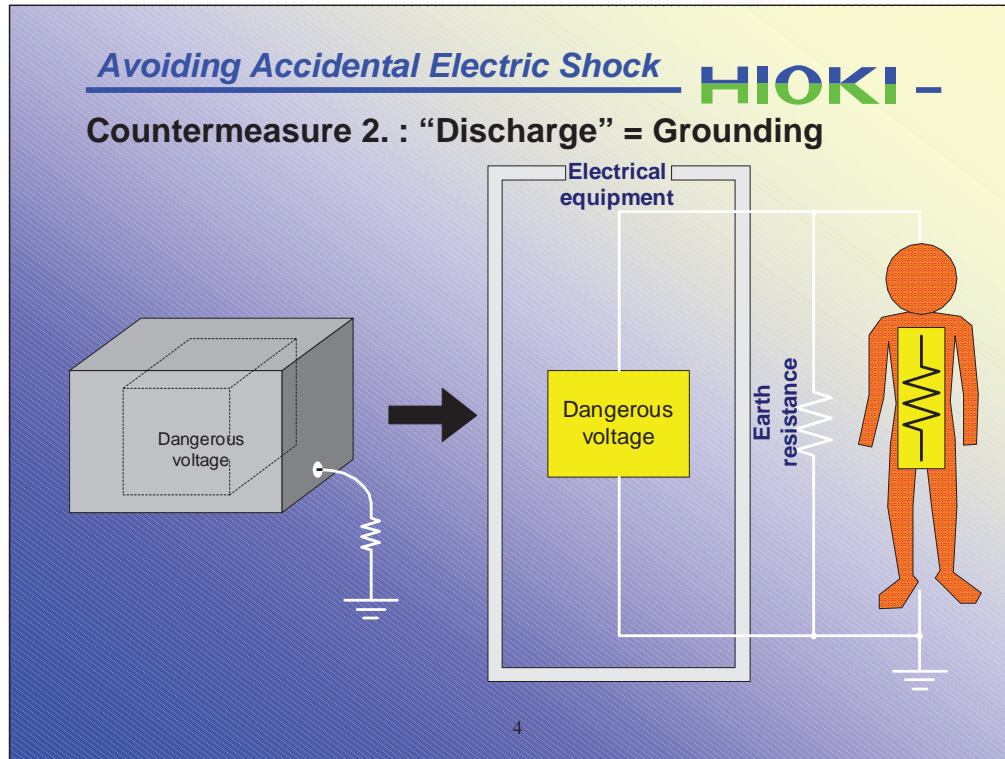

How about discharging dangerous voltages to earth ground?

This countermeasure consists of grounding the enclosure of the device, using a conductor with very low resistance. In this diagram, this resistance is shown as a resistor between the device and earth ground. When a body touches the control panel, the body's resistance and the grounding resistance are connected in parallel. As the ground resistance is a few hundred milliohms and the body's resistance is several kOhms, very little electric current is allowed to flow through the body.

When the enclosure of an electrical device is not insulated from the internal circuitry, dangerous voltage can be present on the enclosure if the ground line is not connected, so the insulation is the fundamental protection.

Safety standards that regulate the effectiveness of this countermeasure are established by the protective grounding test.

Avoiding Accidental Electric Shock

HIOKI-

How much current actually flows?

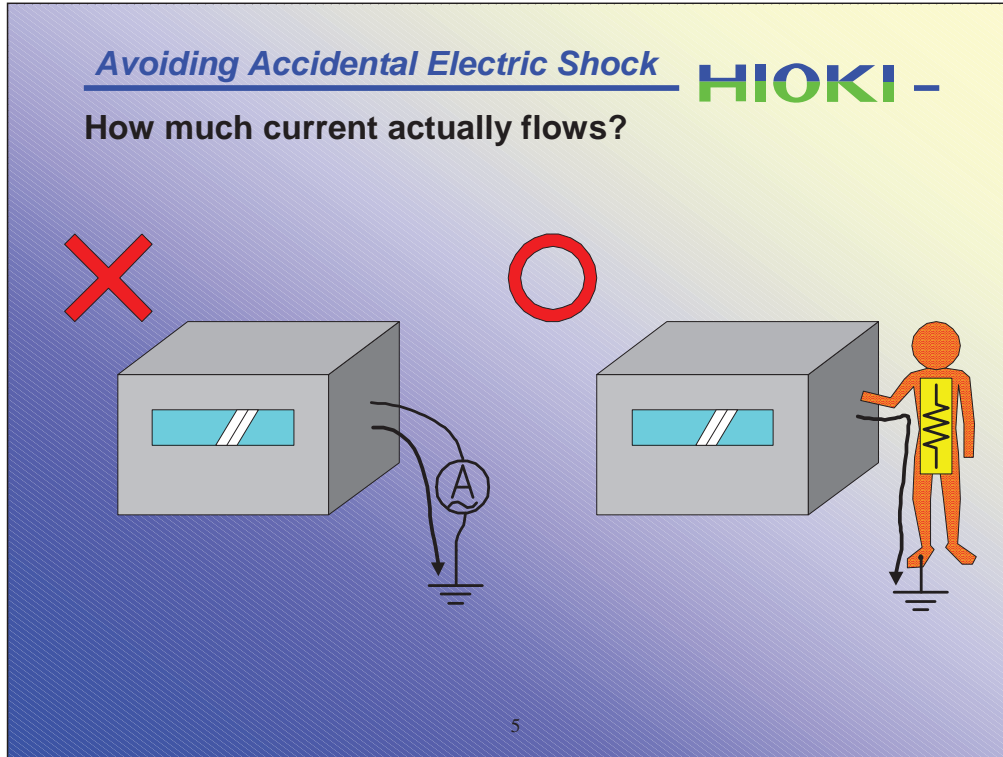

When we say one gets an electric shock, how much current flow are we talking about? Even though we may be unable to sense it, current flow may be present.

The leakage current test measures the amount of current flow.

One might think leakage current could be measured by connecting an ammeter, but in fact that is not possible. Recall that when we feel an electric shock, the current flows through the body's resistance. Thus the current that flows through that resistance is a leakage current.

Actual leakage current testing is performed by measuring the current flowing through a reactive network (with a frequency characteristic similar to a human body), to simulate the body's reactance.

Also, leakage current is measured while simulating a fault in the electrical equipment. For example, leakage current that could result when one touches an enclosure is measured while the ground line or one side of the power line is disconnected, to determine what current would occur during an actual failure.

Avoiding Accidental Electric Shock

HIOKI-

Electrocution?

For general supply frequency

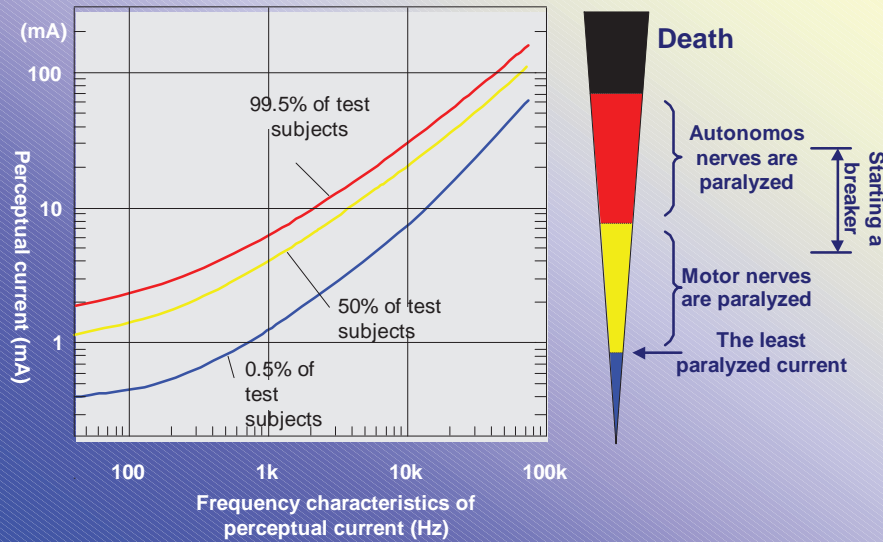

Although we've mentioned electric shock in general, there are actually several grades of shock, ranging from the imperceptible to lethal. We will attempt to summarize the range of perceptual currents.

The graph shows the frequency characteristics of perceptual currents. The vertical axis indicates the perceptual current value, and the horizontal axis is the frequency of the perceptual current. The three curves are plots of the levels perceived by 99.5, 50 and 0.5% of test subjects, respectively. We know that people can sense unexpectedly low current levels; at the commercial mains frequency (50 or 60 Hz), 1 mA of current or less can be felt.

When too much current flows through a human body, the motor nerves begin to be paralyzed, preventing one from being able to escape from the danger. This limiting value is called the separation threshold current. In the case of commercial mains frequencies, this threshold is said to be 9 mA for an adult male, and 6 mA for an adult female.

With a current of tens of milliamperes, the autonomous nerves are paralyzed enough to kill, and several hundreds of milliamperes can result in fire.

One might think that a leakage-current circuit breaker could provide the necessary protection, by automatically cutting the power when the breaker senses leakage current. However, as the sensing current of such a breaker is 5 to 30 mA, it cannot protect the human body, but can only protect electrical equipment (from fire). It is not particularly useful to prevent electric shock.

Reference: Clinical Engineering Journal, Vol. 8, No. 2, 1997

Avoiding Accidental Electric Shock **HIOKI-**

Double and triple protection standard

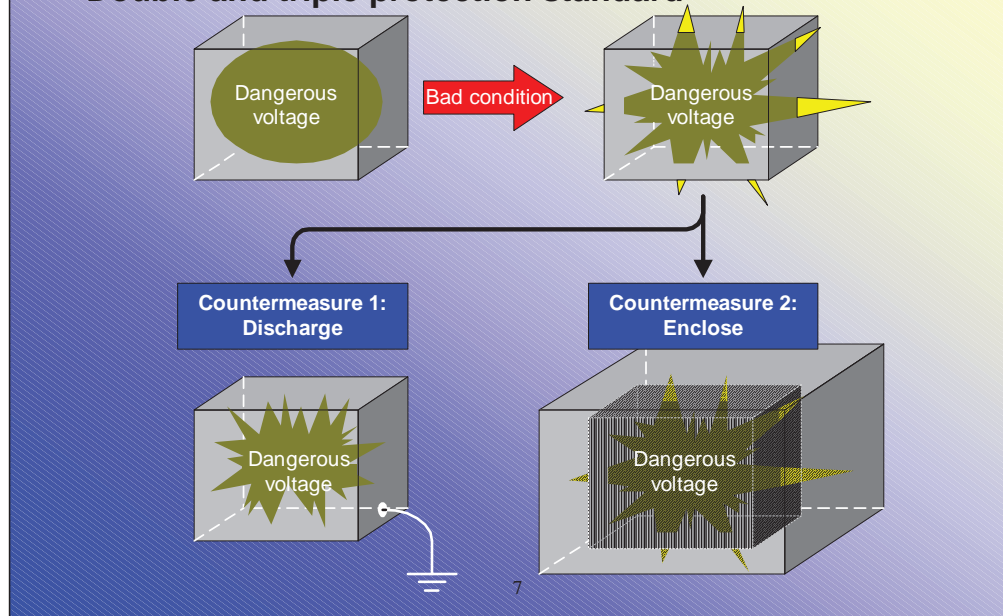

Insulation is fundamental to safety, and insulating against contact with dangerous voltages is fundamental to the design of electrical devices. Tests established by standards to determine the state of insulation are the Withstanding voltage test and the Insulation resistance test. These tests are required not only for electrical devices, but also at the level of individual components.

So what exactly does it mean when a device is damaged or has faulty insulation? The following protective principles are determined by the standards to answer this question.

Protective earthing is one principle. In the event that failure of the insulation causes dangerous voltage to be applied to an equipment enclosure, earthing the enclosure can prevent electric shock. The test regulated by standards to evaluate earthing conditions is the protective grounding test.

The other principle is insulation. Secondary insulation may be applied over the basic insulation to provide double protection. In this case, even if the basic insulation fails, the second layer of insulation retains protection.

Leakage current testing provides an overall evaluation of the effectiveness of any countermeasures to prevent electric shock. Even when insulation and earthing are present, the ultimate test is to determine how much current can flow through the body's resistance. The range of leakage current tests includes more than just these tests. Leakage current is also measured when the earth line is disconnected and the power cord damaged.

In short, leakage current testing to measure current flow through a body actually evaluates the overall safety of both normal and fault conditions of electrical equipment.

Safety Standards for Electrical Equipment

8

To design safe medical equipment, Withstanding Voltage tests, insulation resistance tests, protective grounding tests and leakage current tests are specified by various standards. Here we describe the classifications of electrical equipment, and factors such as insulating structures to better understand these tests.

We will also describe standards that apply specifically to medical equipment. Because medical equipment is a special type of electrical equipment affecting human life support, unique standards are applied.

Safety Standard for Electrical Equipment

HIOKI-

Classification of electrical equipment

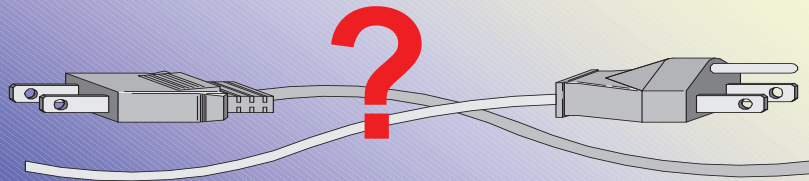

1st protection

Insulation

+

2nd Protection

Earth



Class 1 equipment

Insulation

+

Insulation



Class 2 equipment

9

If you look around at different electrical equipment items, you will find power cords with both two- and three-pin plugs, as well as equipment operating from batteries, either plain or rechargeable. How do the standards differ for these types of equipment? For protection against electric shock, two independent protection methods are required. When equipment is operating correctly, the basic protection (protection under normal conditions) is sufficient, but when the equipment is faulty, supplementary protection (protection under single-fault conditions) is necessary. The basic protection is provided by the insulation method called basic insulation. There are two means by which the supplemental protection can be applied, and the classification of electrical equipment is determined by these means.

Class I equipment incorporates basic insulation for protection under normal conditions, and is earthed for protection under single-fault conditions. The protection from electric shock is provided by the insulation and earthing.

Class II equipment also incorporates basic insulation for protection under normal conditions, but a second layer of insulation is provided for protection under single-fault conditions. The two layers of insulation therefore provide protection from electric shock.

So in answer to the earlier question, the difference between Class I and Class II equipment is the method of protection against single-fault conditions. Class I equipment must be earthed, meaning a three-wire power cord must be used, while Class II equipment is protected without the need for earthing, so a two-wire power cord is used.

Insulation Structure

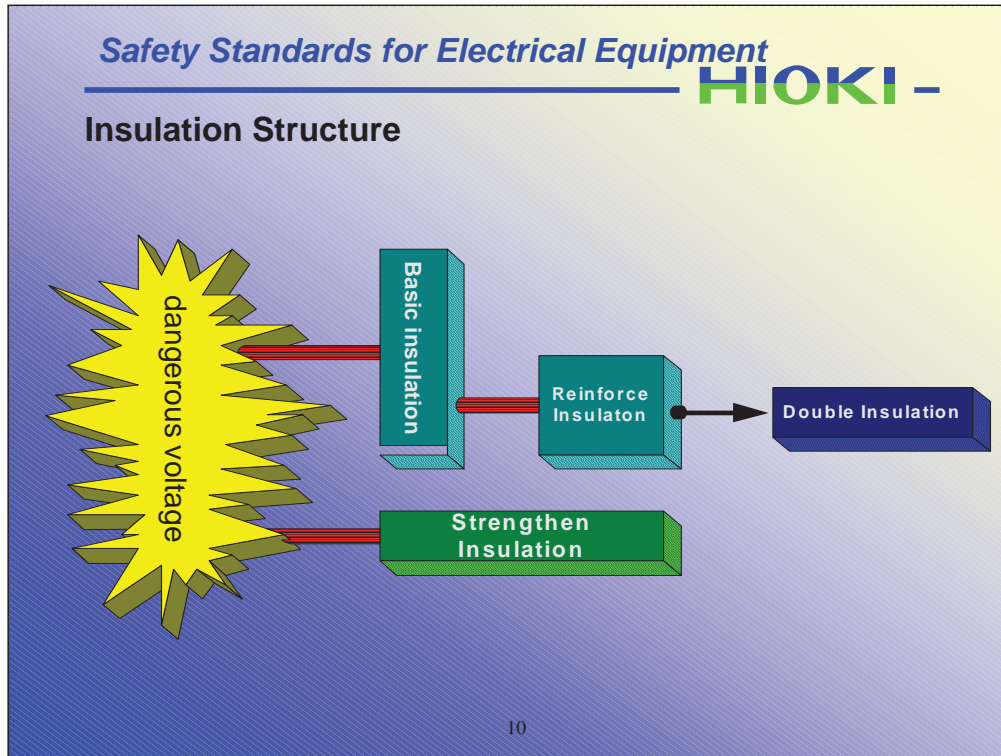

10

We have been using the term "basic insulation" without defining it, so now let's look at the formal classifications of protective insulating structures as regulated by the standards.

The formal insulation structures are basic insulation, supplementary insulation, double insulation and reinforced insulation.

Basic Insulation is the most common type, consisting of a single functional layer. If this protection is damaged, the device may become an electric shock hazard.

Supplementary insulation provides an added level of protection in case the basic insulation is damaged, and so is constructed to function independent of the basic insulation. Class II equipment is that which has supplementary protective insulation over all of the basic insulation on every insulated part.

Double insulation defines the presence of supplementary protective insulation for all basic insulation as applied to Class II equipment.

While the supplementary insulation provides protection when the basic installation fails, Supplementary Insulation is that which provides direct protection against dangerous voltages.

Of course there are many types of insulating materials to be considered. The dielectric covering over a wire conductor is of course one type, but circuit board material is also an insulator, and even air itself is another. The standards specify the clearance and creepage distance for each insulation material.

Class I equipment

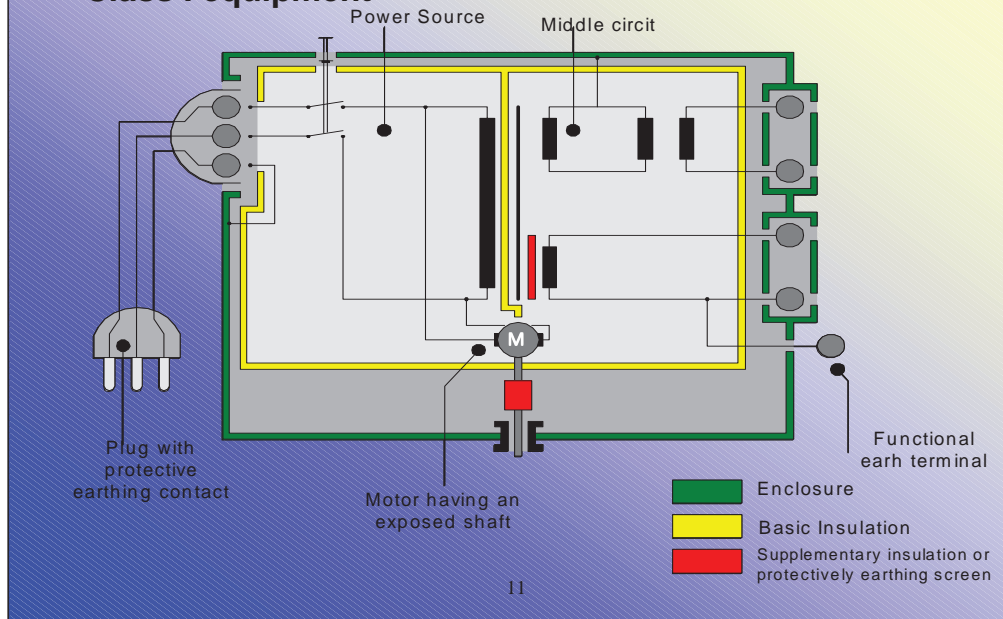

Protection against electric shock in a Class I equipment is provided by the basic insulation and earthing. The basic insulation is intended to prevent the possibility of dangerous voltage from the internal circuitry being applied to the enclosure. The enclosure is therefore earthed to ensure that no dangerous voltage can occur in the event that the basic insulation fails. The protective earth terminal (also called protective earth, which is typically the earthing pin of the power cord) provides the earth connection to earth.

Supplementary insulation is also applied for safety considerations to, for example, a motor having an exposed shaft, or to exposed points of the internal circuitry such as output terminals for converted voltage. However, even though the equipment may contain some supplementary insulation, it is still considered to be Class I because of the necessity for earthing.

This diagram shows the general concept of Class I equipment. The power section is completely covered with insulating material. Of course actual equipment is not structured like this, but you can think of the basic insulation to be constructed as described on the previous page.

Class II equipment

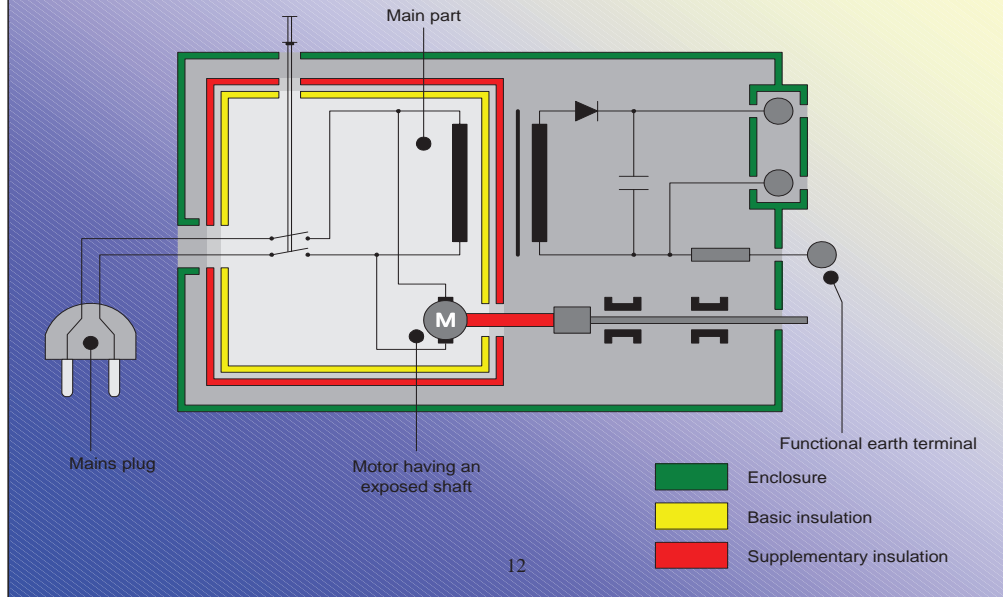

Protection against electric shock in Class II equipment is provided by both basic and supplementary insulation. The basic insulation is applied first, and the supplementary insulation is then applied over it (double insulation). Electric shock prevention is not dependent upon earthing, so a two-wire power cord may be used. Points where one could come into direct contact with internal circuitry, such as the power switch or an exposed motor shaft have reinforced insulation. The reinforced insulation is designed to provide the same degree of insulation as double insulation, to ensure that the entire apparatus retains the same level of safety as the double insulation.

Medical equipment safety standards

HIOKI-

Medical equipment safety standards

International standards

IEC 60065
Audio, video, and similar equipments safety
Part 1

IEC 60335-1
household and similar equipments safety
Part 1

IEC 60601-1 + am 1 + am 2 IEC 60601-1 + am 1 + am 2
Medical electrical equipment
Part 1 : General requirements for safety

IEC 60950-1
Technical information equipment safety
Part 1 : General requirements

IEC 61010-1
Safet for measurering, control and research equipments
Part 1

13

What are the standards applicable to medical equipment? The answers become obvious when we consider the features of such equipment.

Firstly, whenever an electrode or probe applied part is connected directly to a body, the resistance must be minimized as much as possible, as is obvious when you consider the requirements for taking an electrocardiogram. Therefore the permissible level is lower than for other electrical equipment, and a strict pass-fail judgment must be performed.

Secondly, medical equipment is used in such a way that it is in contact with the human body for long periods of time. Other kinds of equipment are normally touched only to change a setting or to carry, but most medical equipment is designed to operate with continual connection to the human body. If appropriate protection against electric shock is not provided, imperceptible leakage currents might flow through the body and produce a feeling of discomfort rather than the intended treatment. At the extreme, electrocution might result instead of the intended treatment.

Finally, it is not possible to know all of the conditions of each person who will be connected. Contact with other types of equipment is almost always by exercise of the will of the person using it, but medical equipment may be connected to unconscious patients. Large leakage current produced by medical equipment could be life threatening.

For the above reasons, leakage current in medical equipment demands special considerations. Protection against electric shock is provided as usual, and then leakage current must be measured in many different situations to ensure adequate safety.

Although not currently required by a specific standard, we believe routine checking of medical equipment is tremendously important for safety.

Leakage Current Measurement

HIOKI-

Leakage Current Measurement

14

Leakage Current Measurement

HIOKI-

Measurement network

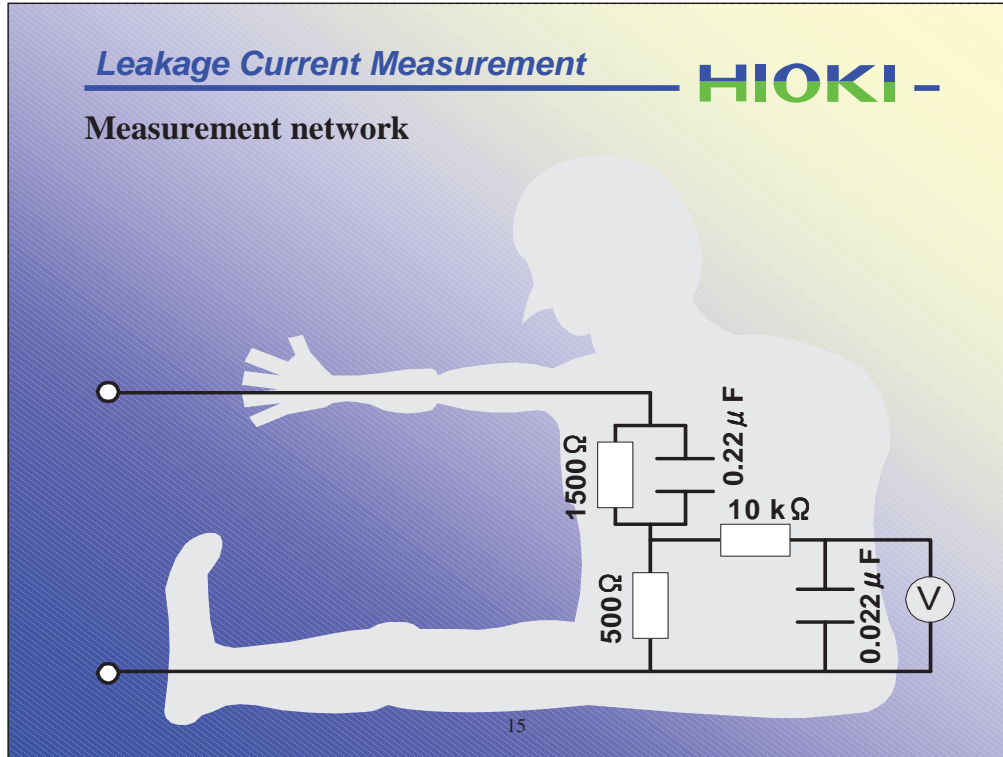

Leakage current can be measured as described so far. The actual measurement points are determined by the particular medical equipment, and measurements are taken during both normal and single fault conditions. If the measured values are within the permissible levels shown in Appendix 1, the test is passed, and if the measured values are above those levels, the test is failed.

But wait a minute! Leakage current is supposed to be that which flows through a human body, isn't it? This means that a simulation of the human body must be provided. To provide valid test results for leakage current flow, we have to create an impedance that duplicates the frequency characteristics of a human body.

We call this impedance simulation of the body a measurement network.

Different standards specify different measurement networks, ranging from a single resistance to a complex network of resistance and capacitance.

The measurement network specified by IEC60601-1 is a combination of resistors and a capacitor. Voltage is measured across the capacitor, and the leakage current is therefore the divided voltage across the 1kOhm resistor. The cut-off frequency is about 1 kHz. The values of the resistors and capacitor are specified by the standard.

The voltmeter used for the measurement is also strictly specified. The measured quantity is the true effective value (true RMS). The voltmeter must have an accuracy of plus-minus 5% of the measured value over a frequency range of DC to one MHz, and input impedance must be at least one MOhm. A voltmeter that satisfies the specs tends to be quite expensive.

Leakage Current Measurement

HIOKI-

Introducing Model 3155-01

You need
many
instruments



Many test
items



16

An isolating transformer, measurement network, polarity toggle switch, switch to interrupt one supply conductor, switch to interrupt an earth conductor and a power source to simulate faulty equipment along with its polarity toggle switch are all required. Also, an expensive voltmeter is necessary in the measurement network.

There are a maximum of 44 measurement conditions for Class I equipment (two placed for enclosures connected to protective earth, and the presence of signal input or output part and type F insulated applied parts) and a minimum of 28 measurements specified in the standards (one place for enclosures not requiring protective earthing, and no signal input or output part or type F insulated applied parts).

Is there a simple way to make such complicated leakage current measurements? Yes! Model 3155 LEAK CURRENT HiTESTER.

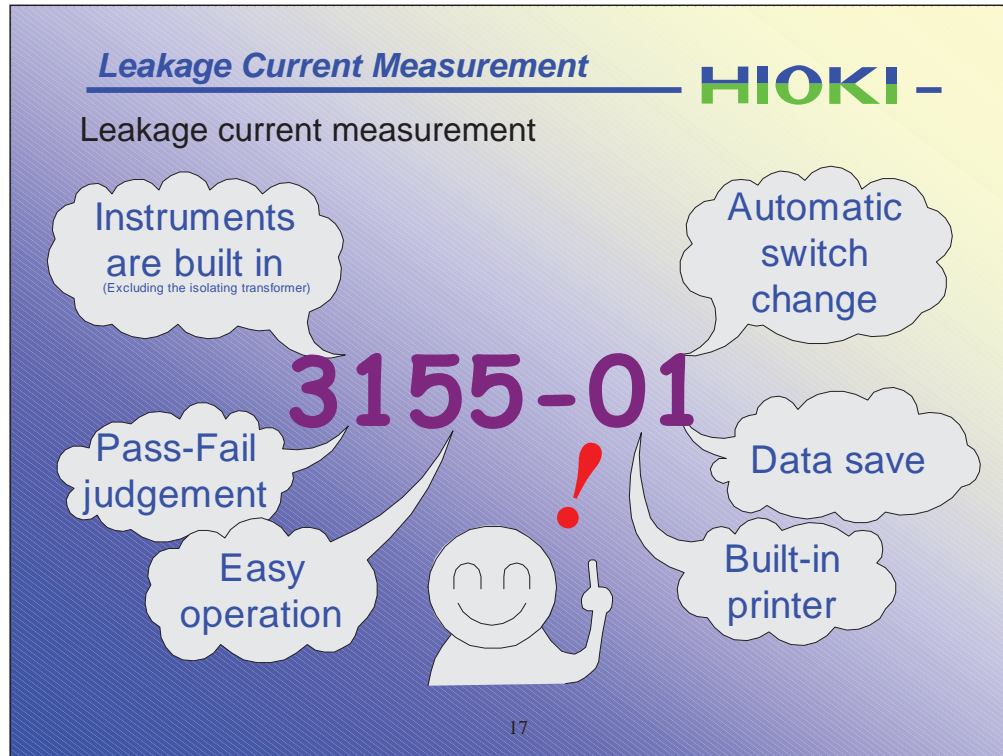

The 3155 LEAK CURRENT HiTESTER is a tester designed to make leakage current measurements simple. Let's look at the features.

- (1) The measurement network, polarity toggle switch, switch to interrupt one supply conductor and switch to interrupt an earth conductor are all built in. The switches are operated automatically, reducing measurement time significantly. The voltmeter within the measurement network satisfies the specification stipulated by the standards.
- (2) A comparator function compares the measurement levels with the permissible levels, and makes a pass-fail judgment.
- (3) Measurements are conducted simply from the LCD and touch panel.
- (4) Data can be saved.
- (5) Results can be printed out.

Also, to provide 110% of the supply voltage for simulating faulty equipment, the Model 9196 APPLY UNIT with built-in polarity toggle switch can be used.

Leakage Current Measurement

HIOKI-



Model 3155 Leak Current HiTESTER

18

This is Model 3155 Leakage Current HiTESTER.

Leakage Current Measurement

HIOKI-

Measuring earth leakage current with the 3155

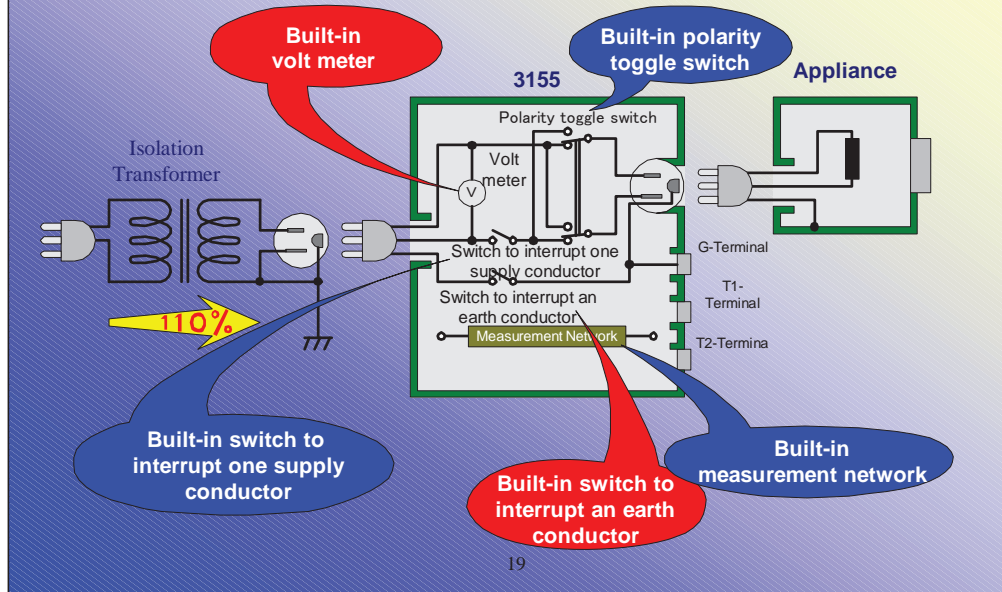

19

Voltage supplied from the 3155 power cord is connected through the switch to interrupt one supply conductor and polarity toggle switch to an outlet on the side of the unit. The equipment to be tested is plugged into this outlet.

As specified by the standards, voltage supplied to the equipment to be tested must be increased by 110% through an isolating transformer. The isolating transformer is connected between the power source and the switch to interrupt one supply conductor. To make it easy to use for maintenance applications, the 3155 is designed to be lightweight, so the isolating transformer is not built in. Therefore power for the 3155 is supplied by connection to the isolating transformer.

Both voltage and current at the outlet are displayed on the 3155 leakage current measurement screen. Set the input voltage to 110% of the mains voltage while watching this screen.

It is especially important to watch the monitor indicators on the 3155 closely. The monitor indicators consist of three LEDs connected between each side of the power supply, and between the cold terminal and the earth line. If a potential difference is present between any of these lines, the corresponding LED lights. The cold side of the power line is usually earthed, so indicator 1 should not be lit. Also, there is normally a potential difference between hot and cold lines, and between hot and earth, so indicators 2 and 3 should be lit. That is the normal condition. However, if indicators 1 and 2 are lit, proper measurements cannot proceed, as this indicates that the hot side is earthed.

Leakage Current Measurement

HIOKI-

Let's set up the 3155

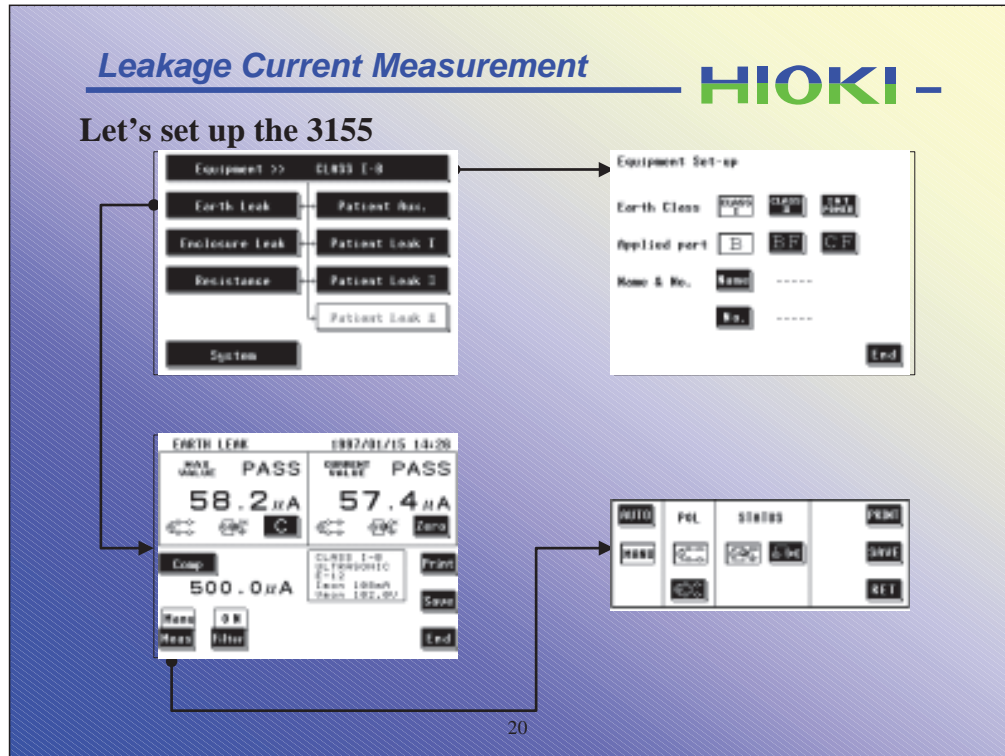

First, settings must be made for the equipment to be tested. Enter the class and type of applied part for the equipment. These settings determine the items to be measured. For example, by selecting Class II, the earth leakage current measurement is disabled.

The name and serial number of the equipment to be tested can also be entered here.

Leakage Current Measurement

HIOKI-

Let's try to measure Enclosure Leakage with the 3155

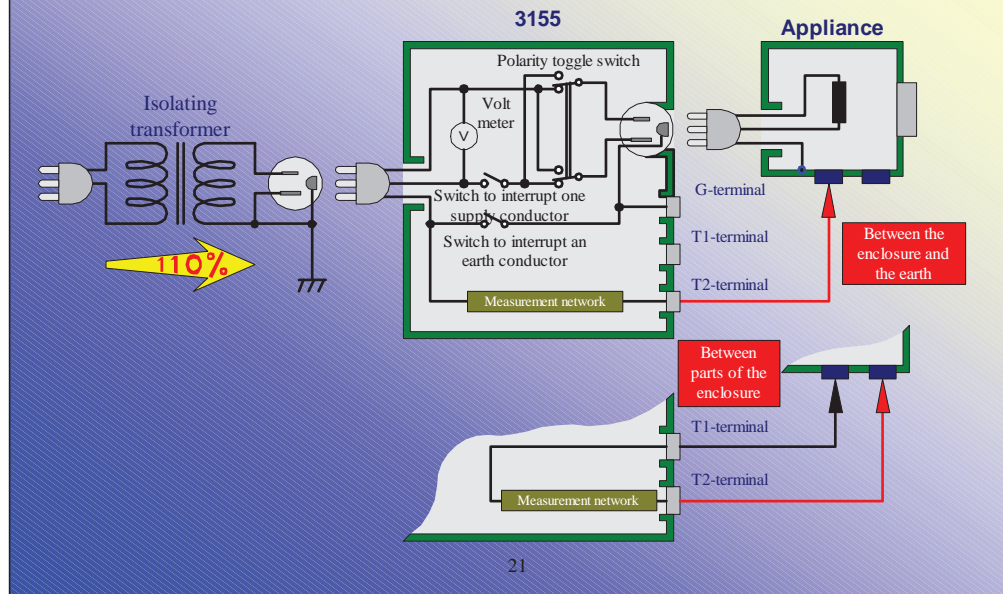

Select "enclosure leak" to measure enclosure leakage current. First, select whether to measure between enclosure and the earth, or between parts of the enclosure. When "between the enclosure and the earth" is selected, the measurement network is connected between terminal T2 and ground. Connect the 9170 test lead from terminal T2 to an grounded test point on the enclosure. When "between parts of the enclosure" is selected, the measurement network is connected between terminals T1 and T2. Connect the 9170 test leads between each of these terminals and the test points on the enclosure of the equipment under test.

There are two measurements required for enclosure leakage current under single fault conditions: interruption of one supply conductor and an earth conductor. When measuring manually, the power polarity and equipment condition (normal or single fault) can be selected. The internal switches are set according to the selection. When measuring automatically, these switches are set automatically to produce the required measurements (six for Class I, or four for Class II).

Leakage Current Measurement

HIOKI-

Other Features

- 3155 100 - 120V, 200V, 240V (Specify when ordering)
- 3155-01..... 100-120V, 200V, 240V (Switchable)
- RS-232C Interface as a standard feature
- Low resistance measurement
 - Simple earth continuity test
- However, standards are not satisfied due to the low current!
 - Is there any suitable equipment??
- By switching the measurement network, leakage current measurements can be made according to a variety of standards



22

Other features of the 3155 LEAK CURRENT HiTESTER are as follows:

- * Model 3155 must be specified for 100, 120, 200 or 240 volts (at the time of ordering), while the Model 3155-01 is voltage selectable for the 100 to 120 range, or 200 or 240 volts. Other mains voltages can be accommodated.
- * An RS-232C interface is provided for control and data storage on a PC.
- * Low resistance measurements and grounding testing of the protective earth line can be done. However, because of the low measurement current used, this protective grounding test does not comply with the standards, so it should be considered merely as a grounding check. We will describe protective grounding testing later.
- * By switching the measurement network, leakage current measurements can be made according to a variety of standards, such as IEC61010-1 and IEC60950, and electrical equipment regulations.

22

Protective Grounding Test

23

Protective grounding testing is applicable only to Class I equipment. Class I equipment prevents electric shock by basic insulation and earthing. If the basic insulation fails, dangerous voltage can be applied to the enclosure. The earth provides a dissipation route for this voltage. Any point where dangerous voltage could appear when the basic insulation fails must be earthed.

The ground connection is made via the earth line or the earthed polarity of the power cord.

Protective earth and functional earth terminals

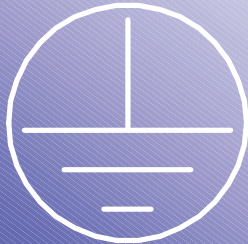

**Protective
earth terminal**

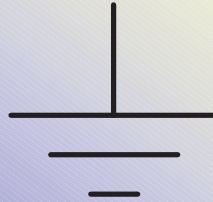

**Functional
earth terminal**

24

Let's now look at the differences between protective earth and functional earth terminals.

As suggested by its name, the purpose of a protective earth terminal is to provide protection. This is the protective insurance of Class I equipment. The functional earth is also connected to earth, but it serves a different purpose: for example, it is intended to be used as a zero-potential base reference point when making measurements.

Despite the same connection to earth, the difference in purpose means that the IEC standards specify different symbols. The functional earth terminal is indicated by an earthing symbol, while the protective earth terminal is encircled.

The protective earth symbol is not widely used. Although the terminal of the earthed polarity of a power cord may be a protective earth, there is no requirement for the symbol to appear there. Equipment that produces high voltage must include a separate protective earth terminal in addition to the earthed polarity of the power cord, and in that case, the protective earth symbol is used.

Protective Grounding Test

HIOKI-

Protective grounding test points

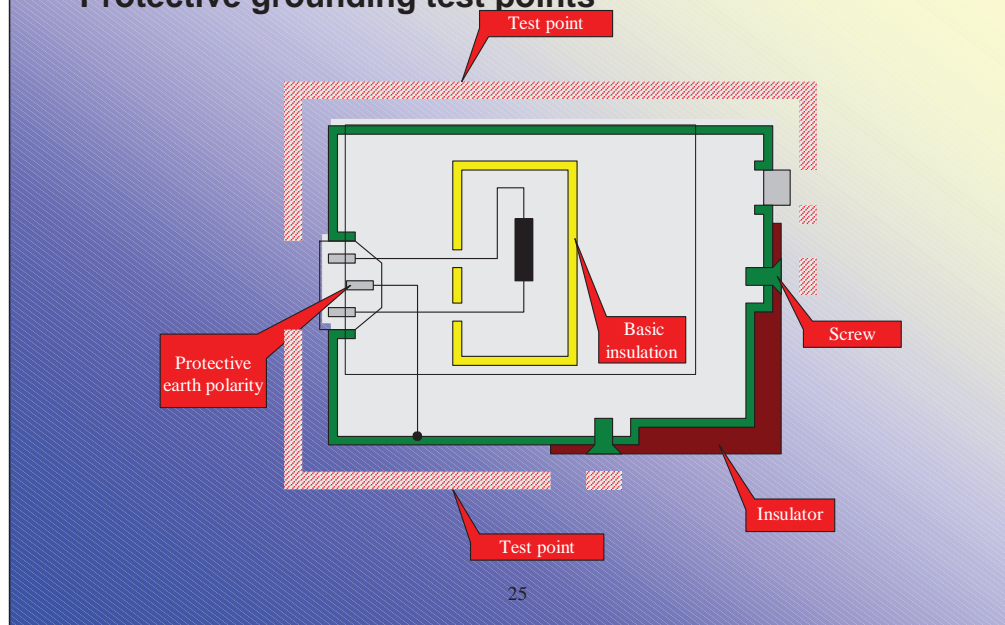

25

Measurements are made between a protective earth terminal and parts where dangerous voltage could occur if the basic insulation was to fail. It is hard to know what exactly is meant by "parts where dangerous voltage could occur if the basic insulation was to fail" (because of the design-specific nature of equipment), so we will just use the term "protective earthed part." For example, a metal enclosure and its mounting screws are such parts.

From this perspective, there are a great many test points. However, the manufacturer of a device generally determines which points are likely to develop faulty ground connections during routine testing, and so usually only these points need to be tested.

Protective grounding test standards

■ **Test current**

■ **The larger of either 25 Amperes or 1.5 times the rated current**

■ **No-load voltage**

less than 12 volts

■ **Test time**

5 to 10 seconds

■ **Permissible level**

0.1 Ohms

26

Here we describe the protective grounding tests regulated by IEC60335-1. The test current is the larger of either 25 Amperes or 1.5 times the rated current. Although the high current might seem to make this a dangerous test, it is in fact safe because the no-load voltage is less than 6 volts: almost the same as several batteries connected in series. Even so, sparks can occur.

Why is such a large current required?

One reason is that this test entails measuring a very small resistance, which requires a large current to obtain a stable measurement. Another reason is the need to simulate a worst possible scenario. For example, consider the state when the basic insulation has failed, causing dangerous voltage to be applied to the enclosure. This could lead to a disaster if the power line was damaged by the short-circuit current. So that the power line is not damaged when the rated current flows as a short circuit, a 1.5 times margin or 25A of test current is added. The standard specifies that connections be made with appropriately large capacity wiring.

The permissible ground resistance is less than 0.1 Ohms. Twenty-five amperes flowing through 0.1 Ohms provides a voltage drop of about 2.5 volts. This permissible level is measured between the protective earth terminal and the safety-earthed part, when the power cord can be removed.

Protective Grounding Test **HIOKI-**

Introducing Model 3157

3157

- Constant current testing method
- Soft-start
- Pass/Fail judgment
- Timer
- Easy operation
- No-load voltage less than 6V

27

For protective ground testing, what operating features would be convenient?

- Because the test current has a specified permissible level, the constant-current testing method is preferable to the slidac method
- Pass-fail judgment of measured resistance and permissible levels
- Controlling the flow of current by a timer, so that current can only flow for a specified time
- No-load voltage less than 6V
- Is it possible to avoid producing sparks?
- Can the tests be conducted smoothly despite the large number of test points?

The 3157 AC GROUNDING HiTESTER is the answer to these requirements

Protective Earth Continuity Test

HIOKI-



Model 3157 AC GROUNDING HiTESTER

28

This is Model 3157 AC Grounding HiTESTER.

28

Protective Earth Continuity Test

HIOKI-

Soft Start Function

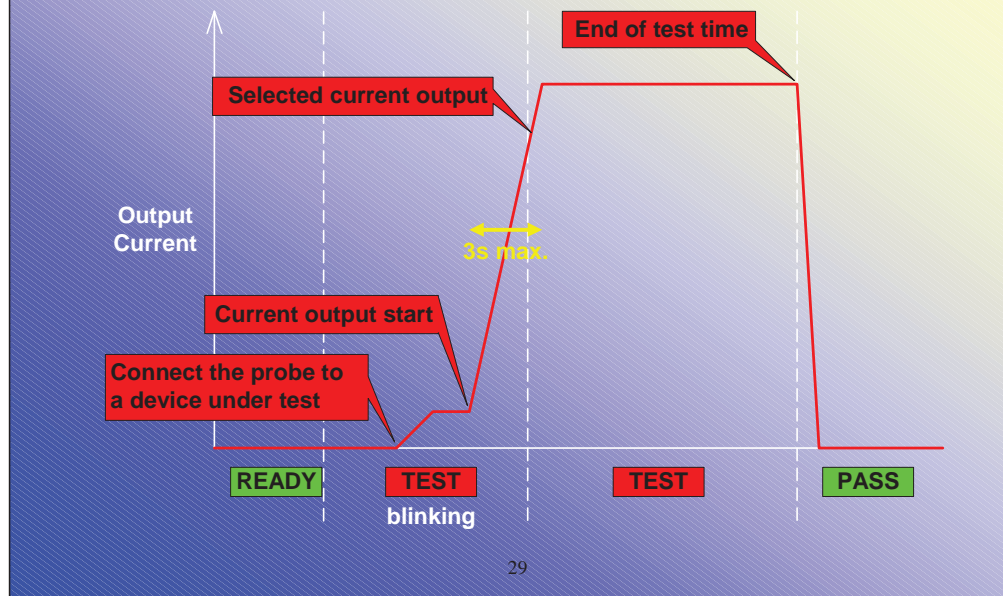

The soft start function is used to avoid sparks.

Before explaining this function, let's think about the situation where there may be sparks. Normally, there are no sparks when probes are properly connected. If voltage allowed to flow a large current between probes, which is about 6V as no load voltage, is generated before connecting probes to the device under test (load), the change of load is from infinity to 0.1-ohms. In other words, current does not flow under the no load condition, but it does flow rapidly when the load is connected.

On the contrary, if you remove probes from the device under test when large current is flowing, you will have sparks.

Now, I would like to explain about the soft start function. To avoid sparks, the 3157 should be monitored to see whether or not its probes are connected to the device under test. It means that there should be a control to flow large current if probes are connected, and not to flow the current if the probe is not connected. Manual control is possible, but the 3157 controls it by via current flowing between the probes.

Actually, when you use the soft start function of the 3157, it always generates a small current between the probes. The current does not flow when the probes are not connected to the device under test. When the probes are connected to the device under test, the resistance becomes about 0.1-ohm and then, the current flows. The 3157 always monitors this current value difference and detects if it is connected to the device under test or not.

The current cannot be measured when the device under test has extremely large resistance because of very low voltage. Therefore, there is a resistance range to enable the soft start function. It is 0.2-ohms or less. By taking into account that the allowance level of protective earth continuity test is 0.2-ohms with a fixed power supply cord, it is clear that the resistance for the soft start function has no problems.

Protective Earth Continuity Test

HIOKI-

Let's test protective earth continuity with the 3157-01

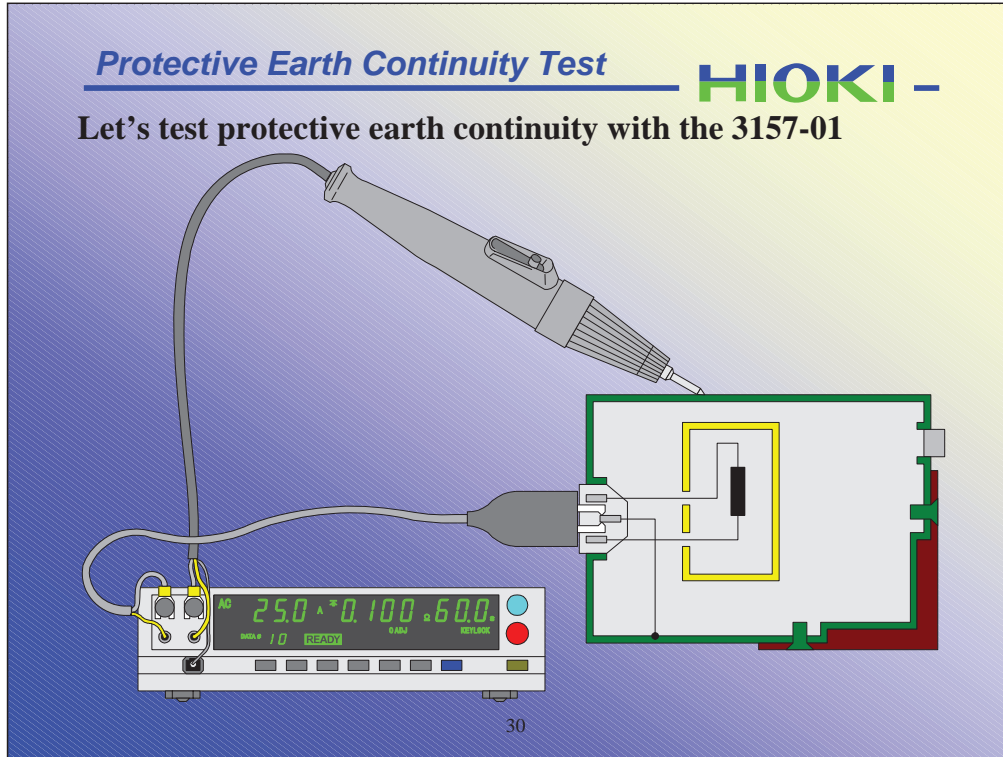

The probes of the 3157 AC Grounding HiTESTER are the 9269 Current Probe and the 9297 Current Apply Probe with switch. The 9296 is mainly used to clip the earthing pole of a voltage inlet. The 9297 has a current output switch which helps with quick testing.

To begin with, enter the output current value, test upper limit value for either resistance or voltage, and test period. You can input these values by using the cursor keys for up/down and right/left. Then, all you have to do is to connect the probes to the device under test and press the start key. Because of the soft start function, the current flows only if the connection is properly made.

As the test current is generated by the constant current method, the 3157 can output the selected current constantly without the effect of load shift. The standards require the allowance range of test current at +/-10%, and constant current output is important for the accurate testing.

Protective Earth Continuity Test

HIOKI-

Other Functions

- 3157 - - - 100 to 120V
- 3157-01 - - - 100 to 120V, 200 to 240V, auto selection
- RS-232C interface, GP-IB interface, Printer
- Can be connected to the 3155 through RS-232C - Transfer the measurement data of the 3157 to the 3155, and print out the data by using the internal printer of the 3155.
- Small, Light (Approx. 7kg, about 50% of previous model)
- Various functions



31

Now, I will introduce the functions of the 3157 AC Grounding HiTESTER.

- The 3157 has a 100 to 120V power supply, but the 3157-01 has an automatic power supply selection for 100 to 120V and 200 to 240V. So, the 3157-01 is able to cover the various power supply voltage systems around the world.
- You can change settings and manage the measurement data from your PC through the RS-232C or GP-IB interface. By using the RS-232C and printer, you can print out the test results.
- The 3157 can be connected to the 3155 Leak Current HiTESTER via RS-232C. Then, you can manage the test data together with the leakage current measurement data. The test results can be printed out using the internal printer of the 3155 as well.
- Since the 3157 is designed to be compact and light weight, it can be useful for maintenance works.
- The 3157 is suitable for the various applications by combining the different functions.

Insulation and Withstanding Voltage Tests

32

The withstanding voltage test is to test the insulation capability of a device. It is different from other tests, and is closer to a durability test or destructive test. This test is made if the current flows or not, which means if the insulation resistance is kept or not, by applying the high voltage. It is a very dangerous test because of the high voltage generation. The high voltage value applied to the device is different by the basic insulation, supplementary insulation or reinforced insulation; however, the basic idea is about 10 times higher than the rated voltage applied in this test.

There are many points to be tested for withstanding voltage. R&D engineers for electric devices always need consider how to design the insulation of a product. For example, whether or not to put a transformer far from the signal output terminal, or whether or not there is enough distance between the power supply circuit and other circuits. The withstand voltage test is often used to check these insulation points. In most cases, there is a withstanding test for components according to the standards for that respective components.

Points for insulation and withstanding voltage tests

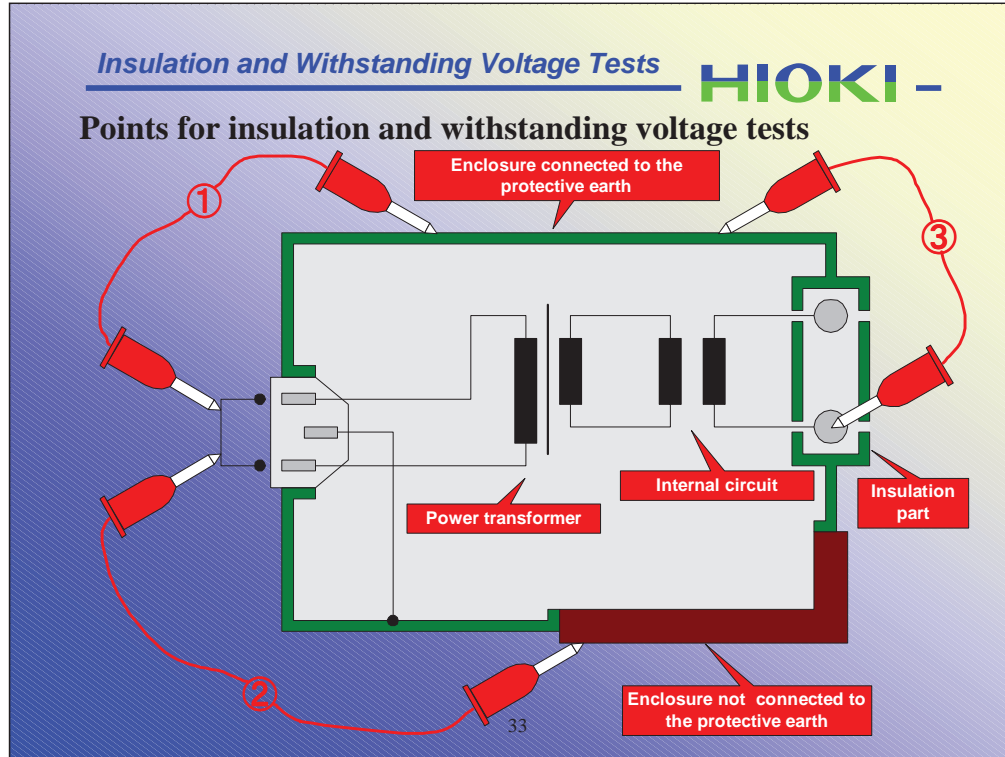

Insulation and withstanding voltage tests basically check the points where it shows whether or not basic insulation, supplementary insulation, or reinforced insulation is properly made. I would like to introduce some typical test points.

(1) Between the power supply line and enclosure connected to the protective earth

The device is Class I because it is connected to the protective earth. In this instance, the test is the withstanding capability between the hazardous voltage, which is the power supply line, and enclosure connected to the protective earth. In other words, it tests the basic insulation.

(2) Between the power supply line and enclosure not connected to the protective earth

There are both class I devices with enclosure not connected to the protective earth and the enclosure of class II devices. As the enclosure is not connected to the protective earth, the device must have supplementary or reinforced insulation if it is designed according to standards. Therefore, the 3157 is used to test the supplementary or reinforced insulation.

(3) Between insulation part and enclosure

The test is made to see if the insulation part is properly insulated electrically or not. The test is applied to the basic insulation.

The test points for insulation test and withstanding voltage test are basically same

INSULATION Voltage Test

HIOKI-

Functions

- ③ **Insulation Measurement based on Safety Standards**
Home appliance/Electric Equipment etc.
- ③ **INSULATION RESISTANCE TEST based on Safety Standards**
Machine, Medical, Home appliance, Office equipment etc.
- ③ **INSULATION TEST Electric and Electrical Equipment**
Motor, Printer, Magnetic head, etc.
- ③ **INSULATION TSET for electric and electrical parts**
Transformer, Coil, Switch, Relay, etc.
- ③ **HIGH VOLTAGE TEST for Impedance network**
Resistance Measurement of parts on the actual operation condition



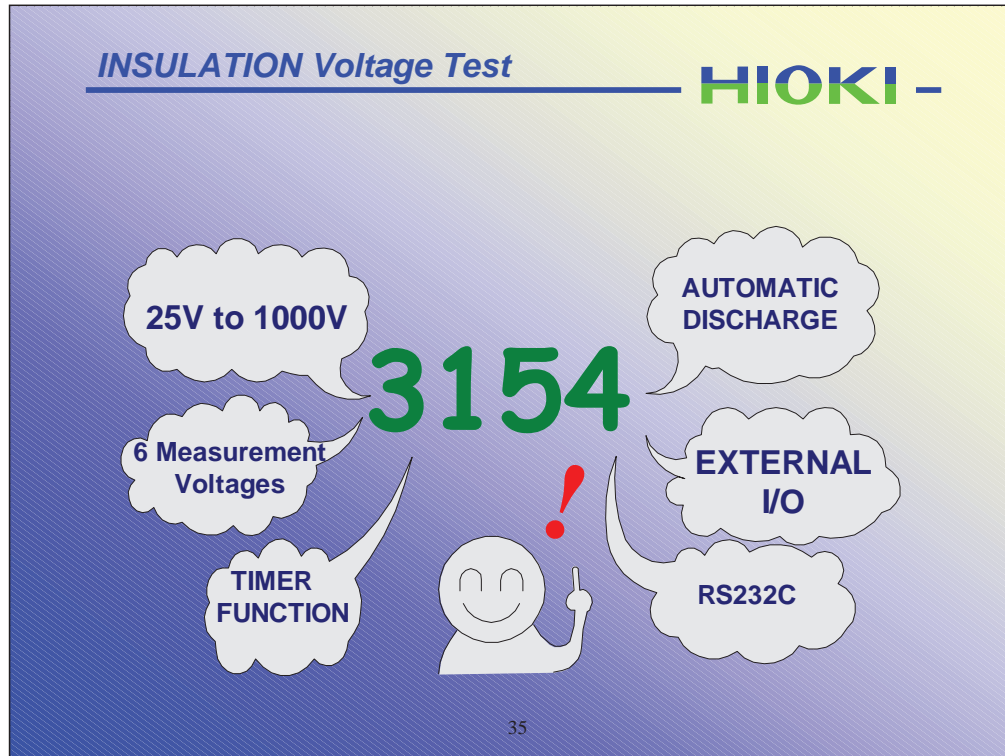

Features of Model 3154 are as follows:

1. Six Measurement voltage are provided in a Single unit, which is 25V, 50V, 100V, 250V and 1000V.
2. Automatic Electrical Discharge Function is available
3. Remote Control Function such as for Start/Stop control from a switching probe is available.
4. Automatic Discharge Function is capable of discharging any charge buildup on the measurement as a result of electrical loading.
5. Comparator Function is available for the production line.
6. Delay Timer Function allows you to delay the starting test timer and comparator, after measurement starts.
7. RS-232C Interface is standard and a printer can be used with the 3154 in order to print out measurement data and comparator results.

INSULATION Voltage Test

HIOKI-



Model 3154 DIGITAL MΩ HI TESTER

36

This is Model 3154.

Withstanding Voltage Test

HIOKI-

Standards for withstanding voltage test

⚡ Test Voltage

Insulation Type	Test Voltage (V)			
	Rated Voltage (*)			Working Voltage (U) (*)
	SELV	≤ 150V	<150, ≤250	> 250V
Basic Insulation	500	1000	1000	1.2U + 700
Supplementary Insulation		1000	1750	1.2U + 1450
Reinforced Insulation		2000	3000	2.4U + 2400

(*) Refer to each relevant standard.

⚡ Test Period is 1 minute.

37

The withstand voltage is tested at the points explained previously. The apply voltage level is defined by the standards. According to IEC 60335-1, the voltage level applied is defined by the rated voltage and working voltage (U). Also, it depends on the insulation construction. For example, for the 240V rated voltage device, 1000V is voltage level that should be applied for basic insulation, 1750V for supplementary insulation, and 3000V for reinforced insulation.

This voltage is applied for 1 minute. The device passes the test if there is no insulation destruction, in other words, the current leakage is less than the specified maximum level, during this one minute.

Withstanding Voltage Test

HIOKI-

3158 is now available!

3158

- Slidac method
- Pass/Fail judgement
- Easy operation
- 500VA transformer capacity
- Voltage comparator function
- Timer

Since the withstanding voltage test applies high voltage and the tester has a big step-up transformer for this purpose, the test becomes very heavy. The leakage current test and protective earth continuity test have the maintenance application, but the withstanding voltage test is mostly operated in the production line. Therefore, safety tests according to standards and easy operation are required.

What type of withstanding voltage tester is the 3158?

- Voltage adjustment method by output voltage knob
- 500VA transformer capacity up to 5kV and zero start switch
- Smooth testing with settings for comparator limit values and timer
- Safe test line design with external I/O, remote control box and standard provided RS-232C

Withstanding Voltage Test

HIOKI-



Model 3158 AC WITHSTANDING VOLTAGE HiTESTER

39

This is Model 3158 AC Withstanding Voltage HiTESTER.

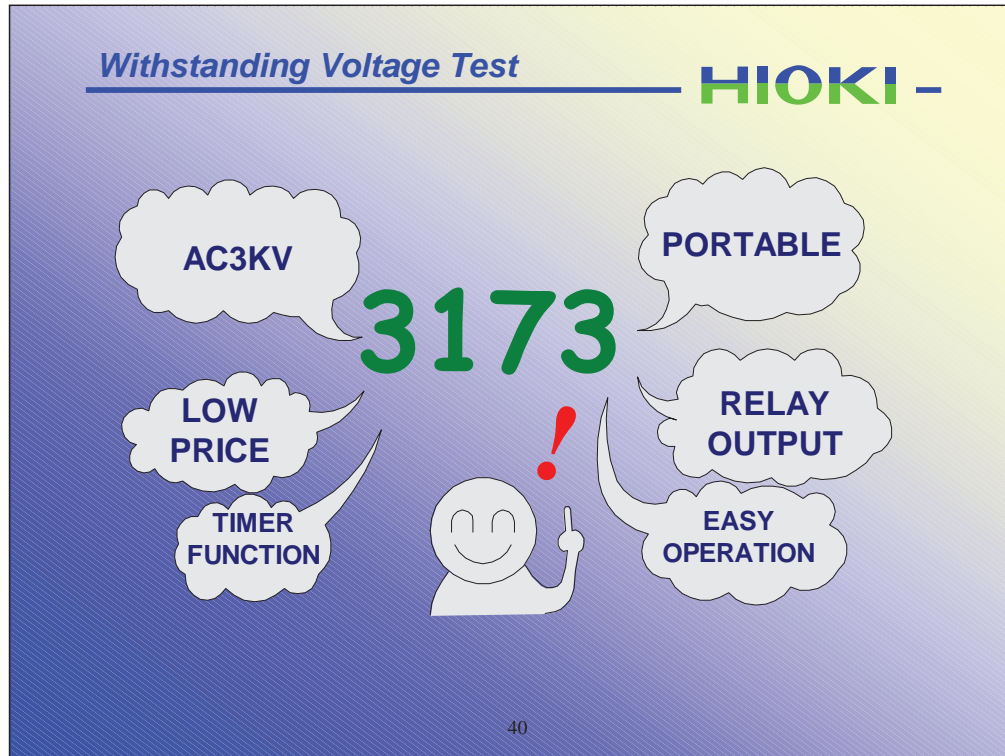

Features of 3173 are as follows,

1. Compact, Light Weight, Economical Price and Easy Operation
2. Timer Function (0 to 99seconds, 1second resolution)
3. Current Cut Off Setting (0.1 to 9.9mA, 0.1mA resolution)
4. External Control by I/O
5. AC 0 to 3kV
6. EN61010-01 standard complied
7. Withstanding Contact Checker will be available soon.

Objects under the Withstanding Test are electric parts and automobile parts, etc.

Withstanding Voltage Test

HIOKI-

Model 3173
Portable
WTHSTANDING
VOLTAGE HiTESTER



41

This is Model 3173 Portable WTHSTANDING VOLTAGE HiTESTER.

41

3158 + 3154

3159

500VA
transformer
capacity

Discharge
function

Continuous
testing



42

There are standards that define the insulation resistance test in addition to the withstanding voltage test.

As these tests have common test points, the test workload can be reduced by combining these two testers.

The 3159 is the tester for this demand.

- The 3158 + 3154 (withstanding voltage tester + insulation resistance tester)
- Continuous test mode for 2 types of tests (withstanding voltage -> insulation resistance, insulation resistance -> withstanding voltage)
- 500VA transformer capacity up to 5kV, and zero start switch for withstanding voltage test
- Smooth testing with settings for comparator limit values and timer
- Safe test line design with external I/O, remote control box and standard equipped RS-232C

Insulation and Withstanding Voltage Tests

HIOKI-



Model 3159 INSULATION/WITHSTANDING HiTESTER

43



42

3153 is now available!

Auto test, programmed test

Stable output

RS-232C, GP-IB standard

3153

AC withstanding voltage (5/60Hz), DC withstanding voltage, insulation resistance

Ramp function

Scanner (option)

44

The withstanding voltage testers with an output voltage knob like the 3173, 358 and 3159 are less expensive, but the test voltage waveform is distorted or becomes smaller if the commercial power supply is distorted or dropped, because they amplify the commercial power supply using a step-up transformer.

Also, these testers cannot memorize the test voltage automatically, although the other settings are memorized.

For more advanced testing, the 3153 satisfies all these demands.

- Automatic test including the voltage settings
- Programmed test for 50 steps maximum (32 files)
- Stable output voltage by feedback control
- Selective test types: AC withstanding voltage (50/60Hz), DC withstanding voltage, insulation resistance
- Safe line design by the standard equipped external I/O, RS-232C and GP-IB
- Ramp up and down functions according to standards
- The optional 3930 High Voltage Scanner for multiple point test

Insulation and Withstanding Voltage Tests

HIOKI-



Model 3153 AUTOMATIC INSULATION/WITHSTANDING HiTESTER

45

This is Model 3153 Automatic Insulation/Withstanding HiTESTER.

45

Summary

HIOKI -

Leakage Current Measurement

Jig preparation,
expensive voltmeter



3155

Protective Earth Continuity Test

Constant current method,
compact and light weight



3157

Withstanding Voltage Test, Insulation Test

Insulation resistance



3154

Inexpensive, portable



3173

500VA, basic testing



3158

**Insulation resistance +
withstanding voltage**



3159

Auto test, stable output



3153

Routine Test

Maintenance

Routine Test

46

These are the electrical tests required by standards for electrical devices. Now, I would like to summarize the characteristics of each test before closing my presentation.

The leakage current measurement require many jigs. Also, the voltage meters compatible to the standards are expensive. We introduced the 3155 to solve these problems. It is more compact and light weight than the conservative large and heavy jigs, so that it can be used for maintenance work for periodic tests.

As the test current and its allowable range for protective earth continuity testing is defined by the standards, a tester with a constant current method is ideal because it removes the effect of voltage fluctuation and load shift. We introduce the 3157 as this ideal protective earth continuity tester. Its small and lightweight design enables to use it for maintenance applications. Also, the instrument allows easy maintenance work with the connection to the 3155 and helps maintain the proper operation of medical equipment.

The insulation resistance and withstanding voltage testers are mostly used in the production lines. As these are hazardous tests, testers able to design a safe system which is a number one priority. We introduced the 3154 as the insulation resistance tester, the 3173 as the portable withstanding voltage tester, and the 3158 as the standard withstanding voltage tester. In addition, we introduced the 3159 that enables both insulation resistance and withstanding voltage tests, and 3153 for automatic testing and stable output.

46

**Model 9267 SAFETY TEST DATA
MANAGEMENT SOFTWARE**

HIOKI-

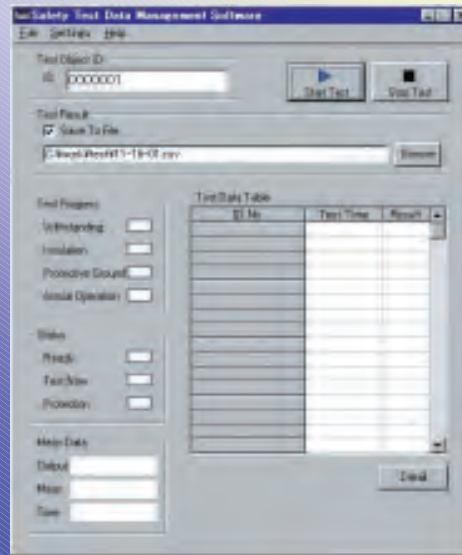

47

Model 9267 Safety Test Data Management Software can be used to control Models 3153, 3159, 3158, 3157 and 3332.

You can arrange the order of test procedures. Also, specific test items and the test order can be chosen and set from those tests such as Withstanding, Insulation, Protected Ground and Continuity.

47

**Model 9267 SAFETY TEST DATA
MANAGEMENT SOFTWARE**

HIOKI



48

The 3153 program setting is also available. This is the program screen for Model 3153. You can save and load 3153 program setting data as a text file

**Model 9267 SAFETY TEST DATA
MANAGEMENT SOFTWARE**



Program Table

File No. 1

Step	Inst	IL	LD	Mode	Unit	PLUP/Delay	PDwn	Time	Updn	Lower
1	Enb1	1-1	1-COM W	AC50	0.3	OFF	OFF	0.3	0.1	OFF
2	Enb1	1-2	1-COM W	AC50	0.3	OFF	OFF	0.3	0.1	OFF
3	Enb1	1-3	1-COM W	AC50	0.3	OFF	OFF	0.3	0.1	OFF
4	Enb1	1-4	1-COM W	AC50	0.3	OFF	OFF	0.3	0.1	OFF
5	Enb1	1-5	1-COM W	AC50	0.3	OFF	OFF	0.3	0.1	OFF
6	Enb1	1-6	1-COM W	AC50	0.3	OFF	OFF	0.3	0.1	OFF
7	Enb1	1-7	1-COM W	AC50	0.3	OFF	OFF	0.3	0.1	OFF
8	Enb1	1-8	1-COM W	AC50	0.3	OFF	OFF	0.3	0.1	OFF
9	Enb1	1-1	1-COM W	AC50	0.2	OFF	OFF	0.3	0.1	OFF
10	Enb1	1-2	1-COM W	AC50	0.2	OFF	OFF	0.3	0.1	OFF
11	Enb1	1-3	1-COM W	AC50	0.2	OFF	OFF	0.3	0.1	OFF
12	Enb1	1-4	1-COM W	AC50	0.2	OFF	OFF	0.3	0.1	OFF
13	Enb1	1-5	1-COM W	AC50	0.2	OFF	OFF	0.3	0.1	OFF
14	Enb1	1-6	1-COM W	AC50	0.2	OFF	OFF	0.3	0.1	OFF
15	Enb1	1-7	1-COM W	AC50	0.2	OFF	OFF	0.3	0.1	OFF
16	Enb1	1-8	1-COM W	AC50	0.2	OFF	OFF	0.3	0.1	OFF
17	Enb1	1-1	1-COM W	AC50	0.2	OFF	OFF	0.3	0.1	OFF
18	Enb1	1-2	1-COM W	AC50	0.2	OFF	OFF	0.3	0.1	OFF
19	Enb1	1-3	1-COM W	AC50	0.2	OFF	OFF	0.3	0.1	OFF
20	Enb1	1-4	1-COM W	AC50	0.2	OFF	OFF	0.3	0.1	OFF
21	Enb1	1-5	1-COM W	AC50	0.2	OFF	OFF	0.3	0.1	OFF
22	Enb1	1-6	1-COM W	AC50	0.2	OFF	OFF	0.3	0.1	OFF
23	Enb1	1-7	1-COM W	AC50	0.2	OFF	OFF	0.3	0.1	OFF
24	Enb1	1-8	1-COM W	AC50	0.2	OFF	OFF	0.3	0.1	OFF
25	Enb1	1-1	1-COM W	AC50	0.2	OFF	OFF	0.3	0.1	OFF
26	Enb1	1-2	1-COM W	AC50	0.2	OFF	OFF	0.3	0.1	OFF
27	Enb1	1-3	1-COM W	AC50	0.2	OFF	OFF	0.3	0.1	OFF
28	Enb1	1-4	1-COM W	AC50	0.2	OFF	OFF	0.3	0.1	OFF
29	Enb1	1-5	1-COM W	AC50	0.2	OFF	OFF	0.3	0.1	OFF

You can save and load 3153 program setting data as a text file.

