

291, 292, 294

100 MS/s Arbitrary Waveform Generators

Users Manual

March 2006
© 2006 Fluke Corporation, All rights reserved. Printed in USA
All product names are trademarks of their respective companies.

LIMITED WARRANTY AND LIMITATION OF LIABILITY

Each Fluke product is warranted to be free from defects in material and workmanship under normal use and service. The warranty period is one year and begins on the date of shipment. Parts, product repairs, and services are warranted for 90 days. This warranty extends only to the original buyer or end-user customer of a Fluke authorized reseller, and does not apply to fuses, disposable batteries, or to any product which, in Fluke's opinion, has been misused, altered, neglected, contaminated, or damaged by accident or abnormal conditions of operation or handling. Fluke warrants that software will operate substantially in accordance with its functional specifications for 90 days and that it has been properly recorded on non-defective media. Fluke does not warrant that software will be error free or operate without interruption.

Fluke authorized resellers shall extend this warranty on new and unused products to end-user customers only but have no authority to extend a greater or different warranty on behalf of Fluke. Warranty support is available only if product is purchased through a Fluke authorized sales outlet or Buyer has paid the applicable international price. Fluke reserves the right to invoice Buyer for importation costs of repair/replacement parts when product purchased in one country is submitted for repair in another country.

Fluke's warranty obligation is limited, at Fluke's option, to refund of the purchase price, free of charge repair, or replacement of a defective product which is returned to a Fluke authorized service center within the warranty period.

To obtain warranty service, contact your nearest Fluke authorized service center to obtain return authorization information, then send the product to that service center, with a description of the difficulty, postage and insurance prepaid (FOB Destination). Fluke assumes no risk for damage in transit. Following warranty repair, the product will be returned to Buyer, transportation prepaid (FOB Destination). If Fluke determines that failure was caused by neglect, misuse, contamination, alteration, accident, or abnormal condition of operation or handling, including overvoltage failures caused by use outside the product's specified rating, or normal wear and tear of mechanical components, Fluke will provide an estimate of repair costs and obtain authorization before commencing the work. Following repair, the product will be returned to the Buyer transportation prepaid and the Buyer will be billed for the repair and return transportation charges (FOB Shipping Point).

THIS WARRANTY IS BUYER'S SOLE AND EXCLUSIVE REMEDY AND IS IN LIEU OF ALL OTHER WARRANTIES, EXPRESS OR IMPLIED, INCLUDING BUT NOT LIMITED TO ANY IMPLIED WARRANTY OF MERCHANTABILITY OR FITNESS FOR A PARTICULAR PURPOSE. FLUKE SHALL NOT BE LIABLE FOR ANY SPECIAL, INDIRECT, INCIDENTAL, OR CONSEQUENTIAL DAMAGES OR LOSSES, INCLUDING LOSS OF DATA, ARISING FROM ANY CAUSE OR THEORY.

Since some countries or states do not allow limitation of the term of an implied warranty, or exclusion or limitation of incidental or consequential damages, the limitations and exclusions of this warranty may not apply to every buyer. If any provision of this Warranty is held invalid or unenforceable by a court or other decision-maker of competent jurisdiction, such holding will not affect the validity or enforceability of any other provision.

11/99

Safety

This generator is a Safety Class I instrument according to IEC classification and has been designed to meet the requirements of EN61010-1:2001 (Safety Requirements for Electrical Equipment for Measurement, Control and Laboratory Use). It is an Installation Category II instrument intended for operation from a normal single phase supply.

This instrument has been tested in accordance with EN61010-1, CSA 22.2 No. 61010-1-04 and UL 61010A-1 and has been supplied in a safe condition. This instruction manual contains some information and warnings which have to be followed by the user to ensure safe operation and to retain the instrument in a safe condition.

This instrument has been designed for indoor use in a Pollution Degree 2 environment in the temperature range 5 °C to 40 °C, 20 % - 80 % RH (non-condensing). It may occasionally be subjected to temperatures between +5 °C and -10 °C without degradation of its safety. Do not operate the instrument while condensation is present.

Use of this instrument in a manner not specified by these instructions may impair the safety protection provided. Do not operate the instrument outside its rated supply voltages or environmental range.



Warning

To avoid the possibility of electric shock:

- **This instrument must be earthed.**
- **Any interruption of the mains earth conductor inside or outside the instrument will make the instrument dangerous. Intentional interruption is prohibited. The protective action must not be negated by the use of an extension cord without a protective conductor.**
- **When the instrument is connected to its supply, terminals may be live and opening the covers or removal of parts (except those to which access can be gained by hand) is likely to expose live parts.**
- **Disconnect the instrument from all voltage sources before opening it for any adjustment, replacement, maintenance or repair.**
- **Any adjustment, maintenance and repair of the opened instrument under voltage shall be avoided as far as possible and, if inevitable, shall be carried out only by a skilled person who is aware of the hazard involved.**
- **Make sure that only fuses with the required rated current and of the specified type are used for replacement. The use of makeshift fuses and the short-circuiting of fuse holders is prohibited.**



Caution

If the instrument is clearly defective, has been subject to mechanical damage, excessive moisture or chemical corrosion the safety protection may be impaired and the apparatus should be withdrawn from use and returned for checking and repair.

Note 

This instrument uses a Lithium button cell for non-volatile memory battery back-up. Typical battery life is 5 years. In the event of replacement becoming necessary, replace only with a cell of the correct type, a 3 V Li/MnO₂ 20 mm button cell type 2032. Do not mix with solid waste stream. Do not cut open, incinerate, expose to temperatures above 60 °C or attempt to recharge. Used batteries should be disposed of by a qualified recycler or hazardous materials handler. Contact your authorized Fluke Service Center for recycling information.

 **Caution**

Do not wet the instrument when cleaning it and in particular use only a soft dry cloth to clean the LCD window.

The following symbols are used on the instrument and in this manual:

 **Caution** - refer to the accompanying documentation, incorrect operation may damage the instrument.

 Mains supply OFF.

 Mains supply ON.

 Alternating current.

 Warning - hazardous voltages may be present.

 Conforms to European Union directives:
EN61010-1-2001, EN61326

 Verified by MET to be in conformance with relevant US
and Canadian Standards:
CSA 22.2 No. 61010-1-04, UL 61010A-1

 Do not mix with solid waste stream. Dispose using a
qualified recycler or hazardous material handler.

 Protective Earth (Ground)

EMC Compliance

This instrument meets the requirements of the EMC Directive 89/336/EEC.

Compliance was demonstrated by meeting the test limits of the following standards:

Emissions

EN61326 (1998) EMC product standard for Electrical Equipment for Measurement, Control and Laboratory Use. Test limits used were:

- a) Radiated: Class A
- b) Conducted: Class B
- c) Harmonics: EN61000-3-2 (2000) Class A;
the instrument is Class A by product category.

Immunity

EN61326 (1998) EMC product standard for Electrical Equipment for Measurement, Control and Laboratory Use. Test methods, limits and performance achieved were:

- a) EN61000-4-2 (1995)
Electrostatic Discharge: 4 kV air, 4 kV contact Performance A.
- b) EN61000-4-3 (1997)
Electromagnetic Field: 3 V/m, 80 % AM at 1 kHz Performance A.
- c) EN61000-4-11 (1994)
Voltage Interrupt: 1 cycle, 100 % Performance A.
- d) EN61000-4-4 (1995)
Fast Transient: 1 kV peak (ac line), 0.5 kV peak (signal lines
and RS232/GPIB ports) Performance A.
- e) EN61000-4-5 (1995)
Surge: 0.5 kV (line to line), 1 kV (line to ground) Performance A.
- f) EN61000-4-6 (1996)
Conducted RF: 3 V, 80 % AM at 1 kHz (AC line only; signal
connections <3 m not tested) Performance A.

According to EN61326 the definitions of performance criteria are:

Performance criterion A: 'During test normal performance within the specification limits.'

Performance criterion B: 'During test, temporary degradation, or loss of function or performance which is self-recovering'.

Performance criterion C: 'During test, temporary degradation, or loss of function or performance which requires operator intervention or system reset occurs.'

Cautions

To ensure continued compliance with the EMC directive the following precautions should be observed:

- a) connect the generator to other equipment using only high quality, double-screened cables.

b) after opening the case for any reason ensure that all signal and ground connections are remade correctly before replacing the cover. Always ensure all case screws are correctly refitted and tightened.

c) In the event of part replacement becoming necessary, only use components of an identical type, see the Service Manual.

Table of Contents

Chapter	Title	Page
	Safety	i
	EMC Compliance	iii
	Emissions.....	iii
	Immunity	iii
1	Introduction and Specifications	1-1
	Introduction.....	1-2
	Introduction.....	1-2
	Specifications.....	1-4
	Waveforms	1-4
	Standard Waveforms.....	1-4
	Arbitrary Waveforms	1-5
	Sequence	1-5
	Output Filter.....	1-5
	Noise	1-5
	Operating modes.....	1-6
	Triggered Burst	1-6
	Gated.....	1-6
	Sweep	1-6
	Tone Switching	1-7
	Trigger Generator.....	1-7
	Outputs	1-7
	Main Output.....	1-7
	Sync Output.....	1-8
	Auxiliary sine out.....	1-8
	System clock	1-8
	Inputs	1-8
	Trig In	1-8
	Modulation In.....	1-8
	Sum In	1-9
	Hold.....	1-9
	Ref Clock In/Out.....	1-9
	Arb Clock In/Out.....	1-9
	Inter-Channel Operation.....	1-9

	Inter-Channel Modulation:	1-9
	Inter-Channel Analog Summing:	1-10
	Inter-Channel Synchronization:	1-10
	Inter-Channel Triggering:	1-10
	Interfaces	1-11
	General	1-11
2	Installation	2-1
	AC Supply Voltage	2-2
	Fuse	2-2
	AC Supply Cable	2-2
	Mounting	2-2
	Ventilation	2-2
3	Connections	3-1
	Front panel connections	3-2
	MAIN OUT	3-2
	SYNC OUT	3-2
	TRIG IN	3-3
	SUM IN	3-3
	MODULATION	3-3
	Rear Panel Connections	3-3
	REF CLOCK IN/OUT	3-3
	HOLD IN	3-3
	ARB CLOCK IN/OUT	3-4
	MAIN OUT	3-4
	RS232	3-4
	GPIB (IEEE-488)	3-5
	USB	3-5
	MEMORY CARD	3-5
4	Initial Operation	4-1
	Introduction	4-2
	Initial Operation	4-2
	Switching On	4-2
	Display Contrast	4-2
	Keyboard	4-2
	Principles of Editing	4-3
	Principles of Operation	4-5
	Clock Synthesis Mode	4-5
	DDS Mode	4-6
5	Standard Waveforms	5-1
	Introduction	5-2
	Standard Waveform Operation	5-2
	Setting Generator Parameters	5-2
	Waveform Selection	5-2
	Frequency	5-2
	Amplitude	5-3
	DC Offset	5-4
	Warning and Error Messages	5-5
	Synchronization Output	5-6

6	Sweep Operation	6-1
	General.....	6-2
	Principles of Sweep Operation	6-2
	Connections for Sweep Operation	6-2
	Setting sweep parameters.....	6-2
	Sweep Range	6-3
	Sweep Time	6-3
	Sweep Type	6-4
	Sweep Spacing.....	6-5
	Sweep Marker.....	6-5
	Sweep Hold	6-5
7	Triggered Burst and Gate	7-1
	General.....	7-2
	Internal Trigger Generator.....	7-2
	External Trigger Input	7-2
	Adjacent Channel Trigger Output	7-3
	Triggered Burst.....	7-3
	Trigger Source	7-4
	Trigger Edge.....	7-4
	Burst Count.....	7-4
	Start Phase	7-5
	Manual Initialization of Inter-Channel Triggering.....	7-5
	Gated mode	7-6
	Gate Source	7-6
	Gate Polarity.....	7-6
	Start Phase	7-6
	Sync Out in Triggered Burst and Gated Modes.....	7-7
8	Tone Mode	8-1
	Introduction.....	8-2
	Tone Frequency	8-2
	Tone Type.....	8-2
	Tone Switching Source.....	8-3
	DTMF Testing With Two Sources	8-3
9	Arbitrary Waveform Generation	9-1
	Introduction.....	9-2
	Arbitrary Waveform Terms.....	9-2
	Principles of Arbitrary Waveform Creation and Modification.....	9-2
	Selecting and Outputting Arbitrary Waveforms	9-3
	Creating New Waveforms	9-4
	Create Blank Waveform.....	9-4
	Create Waveform Copy.....	9-4
	Modifying Arbitrary Waveforms.....	9-5
	Resize Waveform	9-5
	Rename Waveform.....	9-6
	Waveform Info	9-6
	Delete Waveform	9-6
	Edit Waveform	9-7
	Point Edit.....	9-7
	Line Edit.....	9-7
	Wave Insert	9-8

	Block Copy	9-8
	Waveform Amplitude.....	9-9
	Waveform Offset.....	9-10
	Wave Invert.....	9-10
	Position Markers	9-10
	Arbitrary Waveform Sequence	9-11
	Sequence Set-Up	9-12
	Frequency and Amplitude Control with Arbitrary Waveforms	9-13
	Frequency	9-13
	Amplitude.....	9-15
	Sync Out Settings with Arbitrary Waveforms	9-15
	Waveform Hold in Arbitrary Mode	9-15
	Output Filter Setting	9-16
10	Pulse and Pulse-trains	10-1
	Introduction.....	10-2
	Pulse Set-Up	10-2
	Pulse-Train Set-Up	10-4
	Waveform Hold in Pulse and Pulse-Train Modes	10-8
11	Modulation	11-1
	Introduction.....	11-2
	External VCA	11-2
	External SCM	11-3
	Internal Modulation	11-3
12	Sum.....	12-1
	Introduction.....	12-2
	External Sum.....	12-2
	Internal Sum.....	12-3
13	Synchronizing.....	13-1
	Introduction.....	13-2
	Inter-Channel Synchronization	13-2
	Synchronizing Principles.....	13-2
	Master-Slave Allocation.....	13-2
	Phase-Setting Between Channels	13-4
	Other Synchronizing Considerations.....	13-4
	Synchronizing two generators.....	13-5
	Connections for Synchronization	13-6
	Generator Set-Ups	13-6
	Synchronizing.....	13-7
14	Memory Card	14-1
	Introduction.....	14-2
	Card Sizes and Formats	14-2
	Formatting.....	14-3
	Saving Files to a Memory Card	14-3
	Avoiding Long Filenames	14-3
	Storing and Recalling Set-Ups.....	14-3
	Sorting Files.....	14-5

15	System Operations from the Utility Menu	15-1
	Introduction.....	15-2
	Channel Waveform Information.....	15-2
	Warnings and Error Messages	15-2
	Remote Interface Set-Up.....	15-2
	SYS/REF Clock In/Out and System Clock Setting	15-2
	Power On Setting	15-3
	System Information.....	15-3
	Calibration	15-4
	Copying Channel Set-Ups	15-4
16	Calibration.....	16-1
	Introduction.....	16-2
	Equipment Required	16-2
	Calibration Procedure	16-2
	Setting the Password.....	16-2
	Password Access to Calibration	16-3
	Changing the Password	16-3
	Calibration Routine.....	16-3
	Remote Calibration	16-6
17	Remote Operation	17-1
	Introduction.....	17-2
	Address and Baud Rate Selection.....	17-2
	Remote/Local Operation.....	17-2
	RS232 interface.....	17-3
	Single Instrument RS232 Connections.....	17-3
	Addressable RS232 Connections.....	17-3
	RS232 Character Set.....	17-4
	Addressable RS232 Interface Control Codes	17-4
	Full List of Addressable RS232 Interface Control Codes	17-6
	USB Interface	17-6
	GPIB Interface	17-6
	GPIB Subsets.....	17-7
	GPIB IEEE Std. 488.2 Error Handling.....	17-7
	GPIB Parallel Poll	17-7
	Status Reporting.....	17-8
	Standard Event Status and Standard Event Status Enable Registers.....	17-8
	Status Byte Register and Service Request Enable Register.....	17-9
	Power-On Settings.....	17-10
	Remote commands.....	17-10
	RS232 Remote Command Formats.....	17-10
	GPIB Remote Command Formats.....	17-11
	Command List	17-11
	Channel Selection.....	17-12
	Frequency and Period.....	17-12
	Amplitude and DC Offset	17-12
	Waveform Selection.....	17-13
	Arbitrary Waveform Create and Delete	17-13
	Arbitrary Waveform Editing	17-15
	Waveform Sequence Control	17-17
	Mode Commands	17-18
	Input/Output Control.....	17-18

	Modulation Commands	17-19
	Synchronizing Commands	17-19
	Status Commands	17-19
	Miscellaneous Commands	17-21
	Remote Command Summary	17-22
18	Maintenance.....	18-1
	Introduction.....	18-2
	Cleaning	18-2
Appendices		
A	AC Supply Voltage	A-1
B	Warning and Error Messages	B-1
C	SYNC OUT Automatic Settings	C-1
D	Factory System Defaults	D-1
E	Waveform Manager Plus.....	E-1
F	Block Diagrams.....	F-1
G	Front and Rear Panel Drawings.....	G-1

List of Figures

Figure	Title	Page
4-1.	Single-Channel Simplified Block Diagram.....	4-6
4-2.	Clock Synthesis Mode.....	4-6
4-3.	Direct Digital Synthesis Mode	4-7
8-1.	Tone Waveform Types.....	8-3
17-1.	Single Instrument RS232 Connections	17-3
17-2.	RS232 Daisy-Chain Instruments	17-3
17-3.	RS232 Daisy-Chain Connector Wiring.....	17-4
17-4.	Status Model.....	17-9
1-1.	Mains transformer connections	1-2
F-1.	Block Diagram: Single Channel.....	F-1
F-2.	Inter-Channel Block Diagram	F-2
G-1.	Model 291 Front Panel.....	G-1
G-2.	Model 292 Front Panel.....	G-2
G-3.	Model 294 Front Panel.....	G-2
G-4.	Model 291 Rear Panel.....	G-2
G-5.	Model 294 Rear Panel.....	G-3

Chapter 1

Introduction and Specifications

Title	Page
Introduction.....	1-2
Specifications.....	1-4
Waveforms	1-4
Standard Waveforms.....	1-4
Arbitrary Waveforms	1-5
Sequence	1-5
Output Filter.....	1-5
Noise	1-5
Operating modes.....	1-6
Triggered Burst	1-6
Gated	1-6
Sweep.....	1-6
Tone Switching	1-7
Trigger Generator.....	1-7
Outputs	1-7
Main Output	1-7
Sync Output.....	1-8
Auxiliary sine out.....	1-8
System clock	1-8
Inputs	1-8
Trig In	1-8
Modulation In.....	1-8
Sum In	1-9
Hold.....	1-9
Ref Clock In/Out	1-9
Arb Clock In/Out.....	1-9
Inter-Channel Operation.....	1-9
Inter-Channel Modulation:	1-9
Inter-Channel Analog Summing:	1-10
Inter-Channel Synchronization:	1-10
Inter-Channel Triggering:	1-10
Interfaces	1-11
General	1-11

Introduction

This range of synthesized programmable arbitrary waveform generators have the following features:

- 1, 2 or 4 independent arb channels
- Additional DC to 50MHz fixed amplitude sine and squarewave outputs on 2- and 4-channel instruments
- Up to 100 MHz sampling frequency
- Sinewaves up to 40 MHz, squarewaves up to 50 MHz
- Output level 2.5 mV to 10 V p-p into 50 Ω with 12 bit vertical resolution
- 1 M points horizontal resolution per channel
- Compact Flash card for non-volatile waveform memory
- Waveform linking, looping and sequencing
- Inter-channel triggering, summing, modulation and phase control
- GPIB, RS232 and USB interfaces

The instruments use a combination of direct digital synthesis and variable clock techniques to provide high performance and extensive facilities in a compact package. They can generate a wide variety of waveforms between 0.1 MHz and 50 MHz with high resolution and accuracy.

Arbitrary waveforms may be defined with 12 bit vertical resolution and from 8 to 1,048,576 horizontal points. In addition a number of standard waveforms are available including sine, square, triangle, ramp and pulse.

Arbitrary waveforms may be replayed at a user specified waveform frequency or period, or the sample rate may be defined in terms of period or frequency. Alternatively, an external arb clock may be used at frequencies up to 50 MHz.

Extensive waveform editing features between defined start and end points are incorporated, including waveform insert, point edit, line draw, amplitude adjust and invert. More comprehensive features are available using the arbitrary waveform creation software supplied. This is a powerful Windows-based design tool that enables the user to create waveforms from mathematical expressions, from combinations of other waveforms, freehand, or using a combination of all three techniques. Waveforms created in this way can be downloaded via the RS232, GPIB or USB interfaces, or they can be transferred to the generator on a removable memory card, written to by the PC using the USB-connected card reader/writer provided.

Up to 500 different waveforms may be stored with the length and name specified by the user; the total size of all the waveforms stored is limited only by the size of the memory card. Waveforms may be linked together to form a sequence of up to 1024 steps. Each waveform may have a user defined repeat count from 1 to 32,768.

All waveforms can be swept over their full frequency range at a rate variable between 1 millisecond and 15 minutes. Sweep can be linear or logarithmic, single or continuous. Single sweeps can be triggered from the front panel, the trigger input, or the digital interfaces. A sweep marker is provided.

Amplitude modulation is available for all waveforms and is controlled from the previous channel or from an external generator via the **MODULATION** input socket.

Signal summing is available for all waveforms and is controlled from the previous channel or from an external generator via the **SUM** input socket.

All waveforms are available as a triggered burst, whereby each active edge of the trigger signal will produce one burst of the carrier. The number of cycles in the burst can be set between 1 and 1,048,575. The gated mode turns the output signal on when the gating signal is true and off when it is false. Both triggered and gated modes can be operated from the previous or next channel, from the internal trigger generator (0.005 Hz to 100 kHz), from an external source (dc to 1 MHz) or by a key press or remote command.

Any number of channels can be synchronized with user defined phase angle between channels. This can be used to generate multi-phase waveforms or synchronized waveforms of different frequencies.

The signals from the **REF IN/OUT** socket and the **SYNC OUT** socket can be used to synchronize two instruments where more than 4 channels are required.

The generator parameters are clearly displayed on a backlit LCD with 4 rows of 20 characters. Soft-keys and sub menus are used to guide the user through even the most complex functions.

All parameters can be entered directly from the numeric keypad. Alternatively most parameters can be incremented or decremented using the rotary control. This system combines quick and easy numeric data entry with quasi-analogue adjustment when required.

The generator has RS232, GPIB and USB interfaces as standard which can be used for remote control of all of the instrument functions or for the down-loading of arbitrary waveforms. As well as operating in conventional RS232 mode the serial interface can also be used in addressable mode whereby up to 32 instruments can be linked to a single PC serial port.

Specifications

Specifications apply at 18 to 28 °C after 30 minutes warm-up, at maximum output into 50 Ω.

Waveforms

Standard Waveforms

Sine, square, triangle, DC, positive ramp, negative ramp, $\sin(x)/x$, pulse, pulse train, cosine, haversine and havercosine.

Sine, Cosine, Haversine, Havercosine

Range:	0.1 mHz to 40 MHz
Resolution:	0.1 mHz or 10 digits
Accuracy:	10 ppm for 1 year
Temperature stability:	Typically <1 ppm/°C.
Output level:	2.5 mV to 10 V p-p into 50 Ω
Harmonic distortion:	<0.15 % THD to 100 kHz; <-60 dBc to 20 kHz <-50 dBc to 1 MHz, <-40 dBc to 10 MHz <-30 dBc to 40 MHz
Non-harmonic spurious:	<-60 dBc to 1 MHz, <-60 dBc +6 dB/octave 1 MHz to 40 MHz

Square

Range:	1 mHz to 50 MHz
Resolution:	1 mHz or 8 digits
Accuracy:	10 ppm for 1 year
Output level:	2.5 mV to 10V p-p into 50 Ω
Rise and fall times:	<8 ns

Triangle

Range:	0.1 mHz to 500 kHz
Resolution:	0.1 mHz or 10 digits
Accuracy:	10 ppm for 1 year
Output level:	2.5 mV to 10V p-p into 50 Ω
Linearity error:	<0.1 % to 30 kHz

Ramps and $\sin(x)/x$

Range:	0.1 mHz to 500 kHz
Resolution:	0.1 mHz (10 digits)
Accuracy:	10 ppm for 1 year
Output level:	2.5 mV to 10V p-p into 50 Ω
Linearity error:	<0.1 % to 30 kHz

Pulse and Pulse Train

Output level:	2.5 mV to 10V p-p into 50 Ω
Rise and fall times:	<8 ns
Period:	
range:	40 ns to 100 s
resolution:	8 digits
accuracy:	10 ppm for 1 year
Delay:	
range:	-99.99 s to +99.99 s
resolution:	0.001 % of period or 10 ns, whichever is greater (8 digits)
Width:	
range:	10 ns to 99.99 s
resolution:	0.001 % of period or 10 ns, whichever is greater (8 digits)

Note that the pulse width and absolute value of the delay may not exceed the pulse period at any time.

Pulse trains of up to 10 pulses may be specified, each pulse having independently defined width, delay and level. The baseline voltage is separately defined and the sequence repetition rate is set by the pulse train period.

Arbitrary Waveforms

Up to 500 user defined waveforms may be stored on the removable memory card. Waveforms can be defined by front panel editing controls, by downloading of waveform data via RS232, GPIB or USB, or by writing directly to the removable memory card using the USB card reader/writer connected to a PC.

Waveform memory size:	1 M points per channel. Minimum waveform size is 8 points
Vertical resolution:	12 bits
Sample clock range:	100 mHz to 100 MHz
resolution:	8 digits
accuracy:	10 ppm for 1 year

Sequence

Up to 1024 waveforms may be linked. Each waveform can have a loop count of up to 32,768.

A sequence of waveforms can be looped up to 1,048,575 times or run continuously.

Output Filter

Selectable between 40 MHz elliptic, 20 MHz Bessel or none.

Noise

Digital noise generated by a 35-bit linear feedback register clocked at 100 MHz. User's external filter defines bandwidth and response.

Operating modes

Triggered Burst

Each active edge of the trigger signal will produce one burst of the waveform.

Carrier waveforms:	All standard and arbitrary
Maximum carrier frequency:	The smaller of 2.5 MHz or the maximum for the selected waveform. 100 Msamples/s for arb or sequence.
Number of cycles:	1 to 1,048,575
Trigger repetition rate:	0.005 Hz to 100 kHz internal, dc to 1 MHz external.
Trigger signal source:	Internal from keyboard or trigger generator. External from TRIG IN or remote interface.
Trigger start/stop phase:	$\pm 360^\circ$, settable with 0.1° resolution, subject to waveform frequency and type.

Gated

Waveform runs while the gate signal is true and stops while false.

Carrier waveforms:	All standard and arbitrary.
Maximum carrier frequency:	The smaller of 2.5 MHz or the maximum for the selected waveform. 100 Msamples/s for arb or sequence.
Trigger repetition rate:	0.005 Hz to 100 kHz internal, dc to 1 MHz external.
Gate signal source:	Internal from keyboard, previous channel, next channel or trigger generator. External from TRIG IN or remote interface.
Gate start/stop phase:	$\pm 360^\circ$, settable with 0.1° resolution, subject to waveform frequency and type.

Sweep

Frequency sweep capability is provided for both standard and arbitrary waveforms. Arbitrary waveforms are expanded or condensed to exactly 4096 points and DDS techniques are used to perform the sweep.

Carrier waveforms:	All standard and arbitrary except pulse, pulse train and sequence.
Sweep mode:	Linear or logarithmic, triggered or continuous.
Sweep direction:	Up, down, up/down or down/up.
Sweep range:	From 1 mHz to 40 MHz in one range. Phase continuous. Independent setting of the start and stop frequency.
Sweep time:	1 ms to 999 s (3 digit resolution).
Marker:	Variable during sweep.
Sweep trigger source:	The sweep may be free run or triggered from the following sources: manually from keyboard, externally from TRIG IN input or remote interface.
Sweep hold:	Sweep can be held and restarted by the HOLD key.

Multi channel sweep Any number of channels may be swept simultaneously with independent sweep parameters for each channel. Amplitude, Offset and Waveform can be set independently for each channel.

Tone Switching

Capability provided for both standard and arbitrary waveforms. Arbitrary waveforms are expanded or condensed to exactly 4096 points and DDS techniques are used to allow instantaneous frequency switching.

Carrier waveforms: All waveforms except pulse, pulse train and sequence.
Frequency list: Up to 16 frequencies from 1 mHz to 40 MHz.
Trigger repetition rate: 0.005 Hz to 100 kHz internal; dc to 1 MHz external.
Usable repetition rate and waveform frequency depend on the tone switching mode.
Source: Internal from keyboard, previous channel, next channel or trigger generator.
External from **TRIG IN** or remote interface.
Tone switching modes:
gated The tone is output while the trigger signal is true and stopped, at the end of the current waveform cycle, while the trigger signal is false. The next tone is output when the trigger signal is true again.
triggered The tone is output when the trigger signal goes true and the next tone is output, at the end of the current waveform cycle, when the trigger signal goes true again.
FSK The tone is output when the trigger signal goes true and the next tone is output, immediately, when the trigger signal goes true again.

Using two channels or two instruments with their outputs summed together it is possible to generate DTMF (dual tone multi-frequency) test signals.

Trigger Generator

Internal source 0.005 Hz to 100 kHz square wave adjustable in 10 μ s steps. 3 digit resolution. Available for external use from any **SYNC OUT** socket.

Outputs

Main Output - one for each channel

Output impedance: 50 Ω
Amplitude: 5 mV to 20 V p-p open circuit (2.5 mV to 10V p-p into 50 Ω). Amplitude can be specified open circuit (hi Z) or into an assumed load of 50 Ω or 600 Ω in V p-p, Vrms or dBm.
Amplitude accuracy: 2 % \pm 1 mV at 1 kHz into 50 Ω .
Amplitude flatness: \pm 0.2 dB to 1 MHz; \pm 0.4 dB to 40 MHz
DC offset range: \pm 10 V.
DC offset plus signal peak limited to \pm 10 V from 50 Ω .
DC offset accuracy: Typically 3 % \pm 10 mV, unattenuated.

Resolution: 3 digits or 1 mV for both amplitude and dc offset.

Sync Output - one for each channel

Multifunction output user definable or automatically selected to be any of the following:

Waveform sync (all waveforms):	A square wave with 50 % duty cycle at the main waveform frequency, or a pulse coincident with the first few points of an arbitrary waveform.
Position markers (arbitrary only):	Any point(s) on the waveform may have associated marker bit(s) set high or low.
Burst done:	Produces a pulse coincident with the last cycle of a burst.
Sequence sync:	Produces a pulse coincident with the end of a waveform sequence.
Trigger:	Selects the current trigger signal. Useful for synchronizing burst or gated signals.
Sweep sync:	Outputs a trigger signal at the start of sweep to synchronize an oscilloscope or recorder. Can additionally output a sweep marker.
Phase lock out:	Used to synchronize two generators. Produces a positive edge at the 0 ° phase point.
Output signal level:	Logic levels of <0.8 V and >3 V, except for sweep sync. Sweep sync is a 3-level waveform: low at start of sweep, high for the duration of the last frequency step at end of sweep, with a narrow 1 V pulses at each marker point.

Auxiliary sine out

Frequency range:	DC to 50 MHz, set by system clock
Output signal level:	1 V p-p into 50 Ω

System clock

Frequency range::	DC to 50 MHz, 0.1 Hz resolution
-------------------	---------------------------------

Inputs

Trig In

Frequency range:	DC to 1 MHz.
Signal range:	Threshold level adjustable ±5 V; maximum input ±10 V
Minimum pulse width:	50 ns for trigger and gate modes; 50 μs for Sweep mode.
Polarity:	Selectable as high/rising edge or low/falling edge.
Input impedance:	10 kΩ

Modulation In

Frequency range:	DC to 100 kHz.
Signal range:	VCA: Approximately 1 V p-p for 100 % level change at maximum output; maximum input ±10 V. SCM: Approximately ±1 V peak for maximum output.

Input impedance: Typically 1 k Ω .

Sum In

Frequency range: DC to 30 MHz (25 MHz on 2- and 4-channel instruments)

Signal range: Approximately 2 V p-p input for 20 V p-p output; maximum input ± 10 V.

Input impedance: Typically 1 k Ω .

Hold

Holds an arbitrary waveform at its current position. A TTL low level or switch closure causes the waveform to stop at the current position and wait until a TTL high level or switch opening which allows the waveform to continue. The front panel **MAN HOLD** key or remote command may also be used to control the hold function. The **HOLD** input may be enabled independently for each channel.

Input impedance: 10 k Ω

Maximum input: ± 10 V.

Ref Clock In/Out

Set to input: Input for an external 10 MHz reference clock. TTL/CMOS threshold level.

Set to output: Buffered version of the internal 10 MHz clock. Output levels nominally 1 V and 4 V from 50 Ω .

Set to phase lock: Used together with **SYNC OUT** on a master and **TRIG IN** on a slave to synchronize (phase lock) two separate generators.

Maximum input: +5 V, -1 V

Arb Clock In/Out

Set to input: Input for external arb clock. TTL/CMOS threshold level.

Set to output: Outputs system clock; logic levels <0.8 V and >3 V.

Frequency range: DC to 50 MHz

Maximum input voltage: +5 V, -1 V

Inter-Channel Operation

Inter-Channel Modulation:

The waveform from any channel may be used to amplitude modulate (AM) or suppressed carrier modulate (SCM) the next channel. Alternatively any number of channels may be modulated (AM or SCM) with the signal at the **MODULATION** input socket.

Carrier frequency: Entire range for selected waveform.

Carrier waveforms: All standard and arbitrary waveforms.

Modulation types:

- AM Double sideband with carrier.
- SCM Double sideband suppressed carrier.

Modulation source:	Internal from the previous channel; external from modulation input socket. The external modulation signal may be applied to any number of channels simultaneously.
Frequency range:	DC to >100 kHz.
Internal AM:	
depth:	0 % to 105 %
resolution:	1 %.
Carrier suppression (SCM):	>40 dB.
External modulation signal range: VCA:	Approximately 1 V p-p for 100 % level change at maximum output.
SCM:	Approximately ± 1 V pk for maximum output.

Inter-Channel Analog Summing:

Waveform summing sums the waveform from any channel into the next channel.

Alternatively any number of channels may be summed with the signal at the **SUM** input socket.

Carrier frequency:	Entire range for selected waveform.
Carrier waveforms:	All standard and arbitrary waveforms.
Sum source:	Internal from the previous channel; external from SUM IN socket.
Frequency range:	DC to >25 MHz.
External signal range:	Approximately 5 V p-p input for 20 V p-p output.

Inter-Channel Synchronization:

Two or more channels may be synchronized together. Each synchronized channel may be assigned a phase angle relative to the other locked channels. Arbitrary waveforms and waveform sequences may be synchronized but certain constraints apply to waveform lengths and clock frequency ratios. With one channel assigned as the master and other channels as slaves a frequency change on the master will be repeated on each slave thus allowing easy generation of multi-phase waveforms at the same frequency.

Channels may be clocked using the master channel, the system clock or an external arb clock.

Phase resolution:	
DDS waveforms:	0.1 degree
non-DDS waveforms:	0.1 degree or 360 degrees divided by the number of points, whichever is the greater.
Phase error:	
all waveforms:	< ± 6 ns (internal clock), < ± 5 ns (external arb or system clock)

The signals from the **REF IN/OUT** socket and the **SYNC OUT** socket can be used to phase lock two instruments where more than four channels are required.

Inter-Channel Triggering:

Any channel can be triggered by the previous or next channel.

The previous/next connections can be used to daisy chain a trigger signal from a start channel, through a number of channels in the chain to an end channel. Each channel receives the trigger out signal from the previous (or next) channel, and drives its selected trigger out to the next (or previous) channel. The end channel trigger out can be set up to drive the start channel, thus closing the loop.

In this way, complex and versatile inter-channel trigger schemes may be set up. Each channel can have its trigger out and its output waveform set up independently. Trigger out may be selected from Waveform End, Position Markers, Sequence Sync or Burst Done.

Interfaces

Full remote control facilities are available through the RS232, USB or GPIB interfaces.

RS232:	Variable Baud rate, 38,400 Baud maximum. 9-pin D-connector.
IEEE-488:	Conforms with IEEE488.1 and IEEE488.2
USB	1.1

General

Display:	20 character x 4 row alphanumeric LCD.
Data entry:	Keyboard selection of mode, waveform etc.; value entry direct by numeric keys or by rotary control.
Memory card:	Removable memory card conforming to the Compact Flash memory card standard. Sizes from 32 MB to 1 GB can be used.
Stored settings:	Up to 500 complete instrument set-ups may be stored and recalled from the memory card. Up to 500 arbitrary waveforms can also be stored, independently of the instrument settings.
Size:	3U (130 mm) high; 212 mm (½ rack) wide (single channel), 350 mm wide (2- and 4-channel); 335 mm deep.
Weight:	4.1 kg (9 lb) (single channel), 7.2 kg (16 lb) (2- and 4-channel).
Power:	220-240 V nominal 50/60Hz; 110-120 V or 100 V nominal 50/60/400 Hz; nominal voltage adjustable internally; operating range ±10 % of nominal; 60 VA max (single channel), 100 VA max (2-channel), 150 VA max (4-channel). Installation Category II.
Operating Range:	+5 °C to 40 °C, 20 to 80 % RH.
Storage Range:	-20 °C to + 60 °C
Environmental:	Indoor use at altitudes up to 2000 m, Pollution Degree 2.
Options:	19 inch rack mounting kit.
Safety:	Complies with EN61010-1, CSA 22.2 No. 61010-1-04 and UL 61010A-1
EMC:	Complies with EN61326

Chapter 2 Installation

Title	Page
AC Supply Voltage.....	2-2
Fuse	2-2
AC Supply Cable.....	2-2
Mounting.....	2-2
Ventilation	2-2

AC Supply Voltage

Check that the instrument operating voltage marked on the rear panel is correct for the local supply. If it is necessary to change the operating voltage, follow the procedure described in Appendix A.

Fuse

Ensure that the correct mains fuse is fitted for the set operating voltage. The correct mains fuse types are listed in Appendix A, together with instructions for fuse replacement.

AC Supply Cable



To avoid the possibility of electric shock, this instrument must be earthed. Any interruption of the mains earth conductor inside or outside the instrument will make the instrument dangerous. Intentional interruption is prohibited. The protective action must not be negated by the use of an extension cord without a protective conductor.

When a three core mains lead with bare ends is provided it should be connected as follows:-

Brown	Mains Live
Blue	Mains Neutral
Green / Yellow	Mains Earth

Mounting

This instrument is suitable both for bench use and rack mounting. It is delivered with feet for bench mounting. The front feet include a tilt mechanism for optimal panel angle.

A rack kit for mounting in a 19-inch rack is available from the manufacturers.

Ventilation

A fan is fitted to the rear panel of each generator. Take care not to restrict the rear air inlet or the vents at the front (sides and underneath). In rack-mounted situations allow adequate space around the instrument and/or use a fan tray for forced cooling.

Chapter 3 Connections

Title	Page
Front panel connections	3-2
MAIN OUT	3-2
SYNC OUT	3-2
TRIG IN	3-3
SUM IN	3-3
MODULATION	3-3
Rear Panel Connections	3-3
REF CLOCK IN/OUT	3-3
HOLD IN	3-3
ARB CLOCK IN/OUT	3-4
MAIN OUT	3-4
RS232	3-4
GPIB (IEEE-488)	3-5
USB	3-5
MEMORY CARD	3-5

Front panel connections

MAIN OUT (1 per channel)

MAIN OUT is the 50 Ω output from the channel's main generator. It will provide up to 20 V p-p into an open circuit or 10 V p-p into a matched 50 Ω load. It can tolerate a short circuit for 60 seconds.



Caution

Do not apply an external voltage to this output.

SYNC OUT (1 per channel)

SYNC OUT is a TTL/CMOS level output which may be set to any of the following signals from the SYNC OUT screen.

waveform sync	A sync marker phase coincident with the MAIN OUT waveform. For standard waveforms, (sine, cosine, haversine, havercosine, square, triangle, $\sin(x)/x$ and ramp), the sync marker is a square wave with a 1:1 duty cycle. The rising edge is at the 0° phase point and the falling edge at the 180° phase point. For arbitrary waveforms the sync marker is a positive pulse coincident with the first few points (addresses) of the waveform.
position marker	When position (pos ' n) marker is selected, the instrument generates a pulse marker pattern for arbitrary waveforms. The pulse pattern is programmable from the edit waveform menu on the MODIFY screen.
Burst done	Provides a signal during gate or trigger modes which is low while the waveform is active at the main output and high at all other times.
Sequence sync	Provides a signal which is low during the last cycle of the last waveform in a sequence and high at all other times.
Trigger	Provides a positive-going version of the actual trigger signal; internal, external, manual and remote all produce a trigger sync.
Sweep sync	Goes high at the start of sweep and remains high for the duration of the first frequency step. In addition, a half-amplitude marker pulse can be set to be output at any of the frequency steps.
Phase lock	Produces a positive edge coincident with the start of the current waveform; this is used for phase locking instruments. This waveform may not appear coherent.

SYNC OUT logic levels are nominally 0 V and 5 V from typically 50 Ω . **SYNC OUT** will withstand a short circuit.



Caution

Do not apply an external voltage to this output.

TRIG IN

This is the external input for trigger, gate, sweep and sequence operations. It is also the input used to synchronize the generator as a slave to another generator which is the master.



Do not apply an external voltage exceeding ± 10 V.

SUM IN

This is the input socket for external signal summing. The channel(s) with which this signal is to be summed are selected on the `SUM` screen.



Do not apply an external voltage exceeding ± 10 V.

MODULATION

This is the input socket for external modulation. Any number of channels may be AM or SCM modulated with this signal; the target channels are selected on the `MODULATION` screen.



Do not apply an external voltage exceeding ± 10 V.

Rear Panel Connections

REF CLOCK IN/OUT

The function of the **REF CLOCK IN/OUT** socket is set from the `ref/sys clock` menu on the `UTILITY` screen (see *System Operations* section).

- input This is the default setting. The socket becomes an input for an external 10 MHz reference clock. The system automatically switches over from the internal clock when the external reference is applied.
- output The internal 10 MHz clock is made available at the socket.
- master/slave When two or more generators are synchronized the slaves are set to `slave` and the master is set to `master`.

As an output the logic levels are nominally 1 V and 4 V from typically 50 Ω . The output will withstand a short circuit. As an input the threshold is TTL/CMOS compatible.



Do not apply external voltages exceeding + 5 V or -1 V to this signal connection.

HOLD IN

Controls the waveform hold function. The input impedance is nominally 10 k Ω .



Do not apply an external voltage exceeding ± 10 V.

ARB CLOCK IN/OUT

Set to an input, this is the input for a user-supplied ARB clock in the frequency range dc to 50 MHz.

Set to an output, it outputs the system clock at TTL/CMOS compatible logic levels.



Do not apply an external voltage exceeding + 5 V or -1 V.

MAIN OUT (1 per channel)

These plugged panel positions are provided for the user to fit a 50 Ω BNC as an **alternative** to each front panel **MAIN OUT** socket where rear panel connections are required in a rack-mounted system. The front panel **MAIN OUT** connection must be carefully disconnected from the pcb and the pcb then rewired, using high quality 50 Ω coax, to the new rear panel connector.



Do not apply external voltages to these outputs.

RS232

9 pin D-connector compatible with addressable RS232 use. The pin connections are shown below:

Pin	Name	Description
1	-	No internal connection
2	TXD	Transmitted data from instrument
3	RXD	Received data to instrument
4	-	No internal connection
5	GND	Signal ground
6	-	No internal connection
7	RXD2	Secondary received data
8	TXD2	Secondary transmitted data
9	GND	Signal ground

Pin 2, 3 and 5 may be used as a conventional RS232 interface with XON/XOFF handshaking. Pins 7, 8 and 9 are additionally used when the instrument is used in addressable RS232 mode. Signal grounds are connected to instrument ground. The RS232 address is set from the remote menu on the **UTILITY** screen; see "*System Operations from the Utility Menu*".

GPIB (IEEE-488)

The GPIB interface is not isolated; the GPIB signal grounds are connected to the instrument ground.

The implemented subsets are:

SH1, AH1, T6, TE0, L4, LE0, SR1, RL1, PP1, DC1, DT1, C0, E2.

The GPIB address is set from the `remote` menu on the `UTILITY` screen; see "*System Operations from the Utility Menu*".

USB

The USB port is connected to instrument ground. It accepts a standard USB cable. If USB has been selected as the current interface and the driver has been installed from the CD the Windows Plug-and-Play function should automatically recognize that the instrument has been connected. See the USB folder on the CD for information on installing the driver on a PC.

MEMORY CARD

The **MEMORY CARD** slot accepts a standard Compact Flash card with capacities from 32 MB to 1 GB. The **MEMORY CARD ACTIVE** lamp on the front panel is lit during memory card reads and writes.

Chapter 4

Initial Operation

Title	Page
Introduction.....	4-2
Initial Operation	4-2
Switching On	4-2
Display Contrast	4-2
Keyboard	4-2
Principles of Editing	4-3
Principles of Operation	4-5
Clock Synthesis Mode	4-5
DDS Mode.....	4-6

Introduction

This section is a general introduction to the organization and principles of the instrument and is intended to be read before using the generator for the first time. Detailed operation is covered in later sections starting with *"Standard Waveform Operation"*.

In this *Users Manual* front panel keys and sockets are shown in capitals, e.g. **CREATE**, **SYNC OUT**; all soft-key labels, entry fields and messages displayed on the LCD are shown in the Courier type-font, e.g. STANDARD WAVEFORMS, sine.

Initial Operation

Switching On

The power switch is located at the bottom left of the front panel.

At power-up the generator displays the installed software revision whilst loading its waveform RAM. If an error is encountered the message `system ram error`, `battery fault` or `firmware updated` will be displayed. If this happens, refer to the *"Warnings and Error Messages"* in appendix B.

Loading takes a few seconds, after which the status screen is displayed, showing the generator parameters set to their default values, with the **MAIN OUT** outputs set to off.

The power-up settings may be preset to those at power-down or to any of the stored settings; chapter 15 *"System Operations from the Utility Menu"* explains how to do this.

You can recall the status screen at any time with the **STATUS** key; a second press returns the display to the previous screen.

On multi-channel instruments the status shown is that of the channel selected by the **SETUP** keys; this is the channel currently enabled for editing and is always the last channel selected, whether power has been switched off or not. You can change the basic generator parameters for the selected channel as described in chapter 5 *"Standard Waveforms"*, and you can switch the output on with the **MAIN OUT** key; the **ON** lamp will light to show that output is on.

Display Contrast

All parameter settings are displayed on the 20 character x 4 row backlit liquid crystal display (LCD). The contrast may vary a little with changes of ambient temperature or viewing angle but can be optimized for a particular environment by using the front panel contrast control. Insert a small screwdriver or trimmer tool through the adjustment aperture marked **LCD** and rotate the control for optimum contrast.

Keyboard

Pressing the front panel keys displays screens which list parameters or choices relative to the key pressed. Selections are then made using the display soft-keys. Numeric values are changed using either the numeric keys or the rotary control, as described later in this chapter under *"Principles of Editing"*.

The keys are grouped as follows:

- **WAVE SELECT** keys call screens from which all standard or already defined arbitrary waveforms can be selected.
- **WAVE EDIT** keys call screens from which arbitrary waveforms can be created and modified.

- **FREQ**uency, **AMPL**itude, **OFFSET** and **MODE** keys display screens which permit their respective parameters to be edited either from the numeric keypad or using the rotary control/cursor keys.
- Numeric keys permit direct entry of a value for the parameter currently selected. Values are accepted in three formats: integer (20), floating point (20.0) and exponential (2 EXP 1).

For example, to set a new frequency of 50 kHz, press **FREQ** followed by **50000 ENTER** or **5 EXP 4 ENTER**.

ENTER confirms the numeric entry and changes the generator setting to the new value.

CE (Clear Entry) undoes a numeric entry digit by digit. **ESCAPE** returns a setting being edited to its last value.

- **MODULATION**, **SUM**, **TRIG IN** and **SYNC OUT** call screens from which the parameters of those input/outputs can be set, including whether the port is on or off.
- **SWEEP** and **SEQUENCE** similarly call screens from which all the parameters can be set and the functions run.
- Each channel has a key which directly switches the **MAIN OUT** of that channel on and off.
- **MAN TRIG** is used for manual triggering (when **TRIG IN** is appropriately set) and for synchronizing two or more generators when suitably connected together. **MAN HOLD** is used to manually pause arbitrary waveform output and sweep; the output is held at the level it was at when **MAN HOLD** was pressed.
- **UTILITY** gives access to menus for a variety of functions such as remote control interface set-up, power-up parameters, error message settings and store/recall set-ups to/from a memory card; the **STORE** and **RECALL** keys can also be used to directly access the memory card settings files.
- The **INTER CH**annel and **COPY CH**annel keys (multi-channel instruments only) directly call screens from which channel-to-channel synchronization and set-up copying can be controlled.
- The **SETUP** keys (multi-channel instruments only) select the channel to be edited; the lamp lights beside the channel currently enabled for editing.
- Eight soft-keys around the display are used to directly set or select parameters from the currently displayed menu; their operation is described in more detail in the next section.
- The **STATUS** key always returns the display to the default start-up screen which gives an overview of the generator's status. Pressing **STATUS** again returns the display to the previous screen.

Further explanations will be found in the detailed descriptions of the generator's operation.

Principles of Editing

Each screen called up by pressing a front panel key shows parameter value(s) and/or a list of choices. Parameter values can be edited by using the rotary control in combination with the left and right arrowed cursor keys, or by direct numeric keyboard entry; choices are made using the soft-key associated with the screen item to be selected. The examples which follow assume factory default settings.

Note

*On multi-channel instruments the channel to be edited must first be selected by pressing the appropriate **SETUP** key; the lamp lights beside the **SETUP** key of the channel currently enabled for editing.*

A diamond beside a screen item indicates that it is selectable; hollow diamonds (◊) identify deselected items and filled diamonds (◆) denote selected items. For example, press **MODE** to get the screen shown below:

```

MODE:
◆continuous
◊gated      setup...◊
◊triggered  setup...◊

```

The filled diamond indicates that the selected mode is `continuous`. Gated or `triggered` modes are selected by pressing the associated soft-key which will make the diamond beside that item filled and the diamond beside `continuous` hollow. This screen also illustrates how an ellipsis (three dots following the screen text) indicates that a further screen follows when that item is selected. In the case of the `MODE` screen illustrated, pressing the `setup...` soft-key on the bottom line brings up the `TRIGGER SETUP` menu; note that selecting this item does not change the selection of `continuous`, `gated` or `triggered`.

Some screen items are marked with a double-headed arrow (↔) when selected to indicate that the item's setting can be changed by further presses of the soft-key, by pressing either cursor key or by using the rotary control. For example, pressing `FILTER` brings up the screen shown below.

```

FILTER
◊mode: auto
◊type: 40MHz eliptic

```

Repeated presses of the `mode` soft-key will toggle the mode between its two possible settings of `auto` and `manual`. Similarly, when `type` is selected, repeated presses of the `type` soft-key (or cursor keys or use of the rotary control) will step the selection through all possible settings of the filter type.

In addition to their use in editing items identified by a double-headed arrow as described above, the cursor keys and the rotary control operate in two other modes.

In screens with lists of items that can be selected (i.e. items marked with a diamond) the cursor keys and rotary control are used to scroll all items through the display if the list has more than three items; look, for example at the `STD` (standard waveform) and `UTILITY` screens.

In screens where a parameter with a numeric value is displayed the cursor keys move the edit cursor (a flashing underline) through the numeric field and the rotary control will increment or decrement the value; the step size is determined by the position of the edit cursor within the numeric field.

Thus for STANDARD FREQUENCY set to 1.00000000 MHz rotating the control will change the frequency in 1 kHz steps. The display will autorange up or down as the frequency is changed, provided that autoranging permits the increment size to be maintained; this will in turn determine the lowest or highest setting that can be achieved by turning the control. In the example above, the lowest frequency that can be set by rotating the control is 1 kHz, shown on the display as 1.00000000 kHz.

This is the limit because to show a lower frequency the display would need to autorange below 1 kHz to xxx.xxxxxx Hz, in which the most significant digit represents 100 Hz, i.e. the 1 kHz increment would be lost. If, however, the starting frequency had been set to 1.00000000 MHz, i.e. a 100 Hz increment, the display would have autoranged at 1 kHz to 900.000000 Hz and could then be decremented further to 100.000000 Hz without losing the 100 Hz increment.

Turning the control quickly will step numeric values in multiple increments.

Principles of Operation

The instrument operates in one of two different modes depending on the waveform selected. Direct digital synthesis (DDS) mode is used for sine, cosine, haversine, triangle, sin(x)/x and ramp waveforms. Clock synthesis mode is used for square, pulse, pulse train, arbitrary and sequence.

In both modes the waveform data is stored in RAM. As the RAM address is incremented the values are output sequentially to a digital-to-analogue converter (DAC) which reconstructs the waveform as a series of voltage steps which are subsequently filtered before being passed to the MAIN OUT connector.

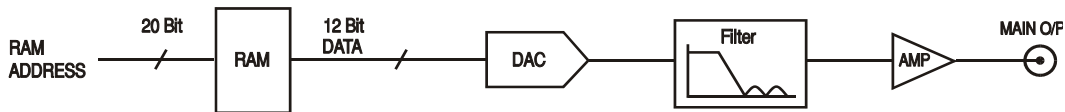

Figure 4-1. Single-Channel Simplified Block Diagram

shc0004f.emf

The main differences between DDS and clock synthesis modes are the way in which the addresses are generated for the RAM and the length of the waveform data.

Clock Synthesis Mode

In clock synthesis mode the addresses are always sequential (an increment of one) and the clock rate is adjusted by the user in the range 100 MHz to 0.1 Hz. The frequency of the waveform is the clock frequency divided by the waveform length, thus allowing short waveforms to be played out at higher repetition rates than long waveforms.

For example the maximum frequency of an eight-point waveform is $100\text{e}6 \div 8$ or 12.5 MHz, but a 1000-point waveform has a maximum frequency of $100\text{e}6 \div 1000$ or 100 kHz.

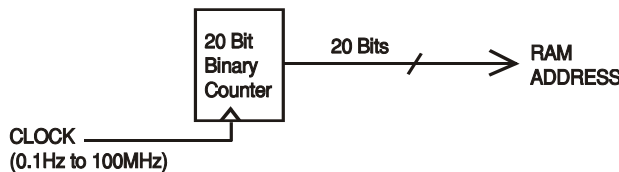

Figure 4-2. Clock Synthesis Mode

shc0005f.emf

Arbitrary waveforms have a user defined length of 8 to 1,048,576 points. Square waves use a fixed length of 2 points and pulse and pulse train have their length defined by the user selected period value.

DDS Mode

In DDS mode all waveforms are stored in RAM as 4096 points. The frequency of the output waveform is determined by the rate at which the RAM addresses are changed. The address changes are generated as follows:

The RAM contains the amplitude values of all the individual points of one cycle (360 °) of the waveform; each sequential address change corresponds to a phase increment of the waveform of 360/4096 degrees. Instead of using a counter to generate sequential RAM addresses, a phase accumulator is used to increment the phase.

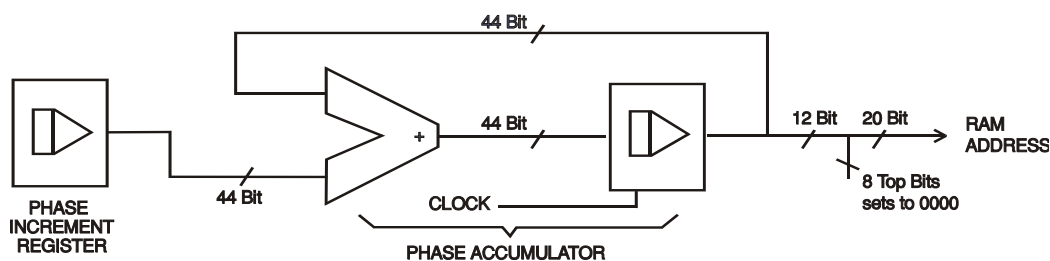

Figure 4-3. Direct Digital Synthesis Mode

shc0006f.emf

On each clock cycle the phase increment, which has been loaded into the phase increment register by the CPU, is added to the current result in the phase accumulator; the 12 most significant bits of the phase accumulator drive the lower 12 RAM address lines, the upper 8 RAM address lines being held low. The output waveform frequency is now determined by the size of the phase increment at each clock. If each increment is the same size then the output frequency is constant; if it changes, the output frequency changes as in sweep mode.

The generator uses a 44 bit accumulator and a 100 MHz clock frequency; the frequency setting resolution is 0.1 mHz.

Only the 12 most significant bits of the phase accumulator are used to address the RAM. At a waveform frequency equal to the clock frequency divided by 4096, approximately 24.4 kHz, the natural frequency, the RAM address increments at every clock. At all frequencies below this (i.e. at smaller phase increments) one or more addresses are output for more than one clock period because the phase increment is not big enough to step the address at every clock. Similarly at frequencies above the natural frequency the larger phase increment causes some addresses to be skipped, giving the effect of the stored waveform being sampled; different points will be sampled on successive cycles of the waveform.

Chapter 5

Standard Waveforms

Title	Page
Introduction.....	5-2
Standard Waveform Operation	5-2
Setting Generator Parameters	5-2
Waveform Selection	5-2
Frequency	5-2
Amplitude.....	5-3
DC Offset	5-4
Warning and Error Messages.....	5-5
Synchronization Output	5-6

Introduction

This section deals with the use of the instrument as a standard function generator, i.e. generating sine, square, triangle, dc, ramp, haversine, cosine, havercosine and $\sin(x)/x$ waveforms. All but the square wave are generated by DDS which gives 10-digit frequency resolution; the square wave is generated by clock synthesis which results in only 8-digit frequency resolution. Refer to *Principles of Operation* in chapter 4 for an explanation of the differences.

Standard Waveform Operation

The STANDARD WAVEFORMS screen also includes arbitrary and sequence for simplicity of switching between these and standard waveforms; they do, however, have their own screens (accessed by pressing **ARB** and **SEQUENCE** respectively) and are described in detail in their appropriate sections. Pulse and pulse-train are also accessed from the standard waveforms screen but are sufficiently different to justify their own section in this manual.

Much of the following descriptions of amplitude and offset control, as well as of mode, sweep, etc., in the following sections, apply to arbitrary and sequence as well as standard waveforms; for clarity, any differences of operation with arbitrary, sequence, pulse and pulse-train are described only in those sections.

Setting Generator Parameters

Waveform Selection

Pressing the **STD** key gives the STANDARD WAVEFORMS screen which lists all the waveforms available:

```

STANDARD WAVEFORMS
◆sine
◇square
◇triangle

```

The rotary control or cursor keys can be used to scroll the full list back and forward through the display. The currently selected waveform (`sine` with the factory defaults setting) is indicated by the filled diamond; the selection is changed by pressing the soft-key beside the required waveform.

Frequency

Pressing the **FREQ** key gives the STANDARD FREQUENCY screen:

```

STANDARD FREQUENCY
10.00000000 kHz
◆freq          period◇

```

With `freq` selected as shown above, the frequency can be entered directly from the keyboard in integer, floating point or exponential format. For example, 12.34 kHz can be

entered as **12340**, **12340-00**, or **1-234 exp 4** etc. However, the display will always show the entry in the most appropriate engineering units, in this case $12 \cdot 34000000$ kHz.

With `period` selected instead of `freq` the frequency can be set in terms of a period, for example $123.4 \mu\text{s}$ can be entered as **0001234** or **123-4 exp -6**; again the display will always show the entry in the most appropriate engineering units. Note that some rounding may occur when switching between frequency and period or vice-versa.

Square wave, generated by clock synthesis, has 8-digit resolution for both frequency and period entry.

Turning the rotary control will increment or decrement the numeric value in steps determined by the position of the edit cursor (flashing underline); the cursor is moved with the left- and right-arrowed cursor keys.

Note that the upper frequency limits vary for the different waveform types; refer to the *Specifications* section in chapter 1 for details.

Amplitude

Pressing the **AMPL** key gives the `AMPLITUDE` screen:

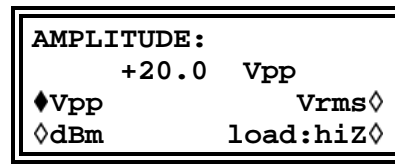

The waveform amplitude can be set in terms of peak-to-peak volts (V_{pp}), rms volts (V_{rms}) or dBm (referenced to a 50Ω or 600Ω load). For V_{pp} and V_{rms} the level can be set assuming that the output is open-circuit (`load:hiZ`) or terminated (`load:50Ω` or `load:600Ω`); when dBm is selected termination is always assumed and the `load:hiZ` setting is automatically changed to `load:50Ω`. Note that the actual generator output impedance is always 50Ω ; the displayed amplitude values for 600Ω termination take this into account.

With the appropriate form of the amplitude selected (indicated by the filled diamond) the amplitude can be entered directly from the keyboard in integer, floating point or exponential format. For example 250 mV can be entered as **250 exp -3** or **250**, etc. The display will always show the entry in the most appropriate engineering units, in this case 250 mV .

Turning the rotary control will increment or decrement the numeric value in steps determined by the position of the edit cursor (flashing underline); the cursor is moved with the left- and right-arrowed cursor keys.

Alternate presses of the \pm key will invert the signal at the **MAIN OUT** socket; if the `DC OFFSET` is non-zero the signal is inverted about the same offset. The exception to this occurs when the amplitude is specified in dBm. Since low level signals are specified in -dBm ($0 \text{ dBm} = 1 \text{ mW into } 50 \Omega = 0.224 \text{ mV rms}$) the - sign is interpreted as part of a new amplitude entry and not as a command to invert the signal.

Note that for DC, $\sin(x)/x$, pulse train, arbitrary and sequence, the amplitude can only be displayed and entered in the V_{pp} form; further limitations on pulse-train, arbitrary and sequence amplitude are discussed in the appropriate sections.

DC Offset

Pressing the **OFFSET** key gives the DC OFFSET screen:

```

DC OFFSET:
  program +0.00 mVdc
  (actual +0.00 mVdc)
          load:hiZ◇

```

The offset can be entered directly from the keyboard in integer, floating point or exponential format, for example 100 mV can be entered as **0.001** or as **100 exp -3**, etc. The display will always show the entry in the most appropriate engineering units, in this case 100 mV. During a new offset entry the **±** key can be used at any time to invert the offset; alternate presses toggle the sign between + and -.

Turning the rotary control will increment or decrement the numeric value in steps determined by the position of the edit cursor (flashing underline); the cursor is moved with the left- and right-arrowed cursor keys. Because the dc offset can have negative values, the rotary control can take the value below zero; although the display may autorange to a higher resolution if a step takes the value close to zero, the increment size is maintained correctly as the offset is stepped negative. For example, if the display shows

```

program = +205 · mVdc

```

with the cursor in the most significant digit, the rotary control will decrement the offset in 100 mV steps as follows:

```

program = +205 · mVdc
program = +105 · mVdc
program = +5 · 00 mVdc
program = -95 · 0 mVdc
program = -195 · mVdc

```

The actual dc offset at the **MAIN OUT** socket is attenuated by the fixed-step output attenuator when this is in use. Since it is not obvious when the signal is being attenuated the actual offset is shown in brackets as a non-editable field below the programmed value.

For example, if the amplitude is set to 2.5 V p-p the output is not attenuated by the fixed attenuator and the actual dc offset (in brackets) is the same as that set. The DC OFFSET display shows:

```

DC OFFSET:
  program +1.50 Vdc
  (actual +1.50 Vdc)
          load: hiZ◇

```

If the amplitude is now reduced to, say, 250 mV p-p, this introduces the attenuator and the actual dc offset changes by the appropriate factor:

```
DC OFFSET:
program +1.50 Vdc
(actual +151 mVdc)
load: hiZ
```

The above display shows that the set dc offset is +1.50 V but the actual offset is +151 mV.

Note

The actual offset value also takes into account the true attenuation provided by the fixed attenuator, using the values determined during the calibration procedure. In the example displayed the output signal is 250 mV p-p exactly and takes account of the small error in the fixed attenuator; the offset is 151 mV (to three significant figures) and takes account of the effect of the calibrated attenuation error on the set offset of 1.50 V.

Whenever the set dc offset is modified by a subsequent change in output level the display shows a warning message. Similarly, settings which would result in peak offset+signal levels outside the range ± 10 V (and therefore clipping) generate a similar warning message. There is additional information on these messages in the *Warnings and Error Messages* section below.

The output attenuation is controlled intelligently to minimize the difference between the programmed and actual offset when the combination of programmed amplitude and offset allows this. Thus when the offset is set to 150 mV, for example, the amplitude can be reduced to nominally 50 mV p-p before the fixed attenuator causes the actual offset to be different from the programmed value.

Warning and Error Messages

Two classes of message are displayed on the screen when an illegal combination of parameters is attempted.

WARNING messages are shown when the entered setting causes some change which the user might not necessarily expect, as in the following two examples:

1. Changing the amplitude from, for example, 2.5 V p-p to 25 mV p-p brings in the step attenuator; if a non-zero offset has been set then this will also be attenuated. The message DC offset changed by amplitude will be shown temporarily on the screen but the setting will be accepted; in this case the actual attenuated offset will be shown in brackets below the set value.
2. With the output level set to 10 V p-p, increasing the dc offset beyond ± 5 V will cause the message Offset + Sum + level may cause clipping. The offset change will be accepted (producing a clipped waveform) and the user may then choose to change the output level or the offset to produce a signal which is not clipped. The word (clip?) will show in the display beside AMPLITUDE or DC OFFSET while the clipped condition exists.

ERROR messages are shown when an illegal setting is attempted, most generally a number outside the range of values permitted. In this case the entry is rejected and the parameter setting is left unchanged, as in the following three examples:

1. Entering a frequency of 1 MHz for a triangle waveform. The error message:
Frequency out of range for the selected waveform is shown.

2. Entering an amplitude of 25 V p-p. The error message:
Maximum output level exceeded is shown.
3. Entering a dc offset of 20 V. The error message:
Maximum DC offset exceeded is shown.

The messages remain on the display for approximately two seconds. The last two messages can be viewed again by pressing the `last error...` soft-key on the **UTILITY** screen. Refer to the section *System Operations from the Utility Screen* for more information.

Each message has a number and the full list appears in appendix B.

The default set-up is for all warning and error messages to be displayed and for a beep to sound with each message. This set-up can be changed on the `error...` menu on the **UTILITY** screen. The `error` menu is shown below:

```

◇error beep: ON
◇error message: ON
◆warn beep: ON
◇warn message: ON
```

Each feature can be turned on and off with alternate presses of the associated soft-key; the factory default is for all features to be on.

Synchronization Output

SYNC OUT is a multifunction CMOS/TTL level output that can be automatically or manually set to be any of the following:

- | | |
|------------------|--|
| waveform sync: | A square wave with 50 % duty cycle at the main waveform frequency, or a pulse coincident with the first few points of an arbitrary waveform. Can be selected for all waveforms. |
| position marker: | If an arbitrary waveform is selected, any point(s) on the main waveform may have associated marker bit(s) set high or low. These will then show as pulses when <code>position marker</code> is selected. |
| burst done: | Produces a pulse coincident with the last cycle of the burst. |
| sequence sync: | Produces a pulse coincident with the end of a waveform sequence. |
| trigger: | Selects the current trigger signal (internal, external or manual). Useful for synchronizing burst or gated signals. |
| sweep sync: | Outputs the sweep trigger and sweep marker signals. |
| phase lock: | Used to synchronize two or more generators. Produces a positive edge at the 0° phase point. |

The setting up of the signals themselves is discussed in the relevant sections later in this manual. Triggering is described in the *Triggered Burst and Gate* chapter and `position marker` in the *Arbitrary Waveform Generation* chapter.

Pressing the **SYNC OUT** key calls the `SYNC OUT` set-up screen:

```
SYNC OUT
◄output: on
◊mode: auto
◄src: waveform sync
```

SYNC OUT is turned on and off by alternate presses of the `output` soft-key.

The selection of the signal to be output from the **SYNC OUT** socket is made using the `src` (source) soft-key; repeated presses of `src` cycle the selection through all the choices (`waveform sync`, `position marker`, etc.) listed above. Alternatively, with the `src` selected (double-headed arrow) the rotary control or cursor keys can be used to step backwards and forwards through the choices.

The source selection of the **SYNC OUT** waveform can be made automatic (`auto`) or user-defined (`manual`) with alternate presses of the `mode` soft-key. In automatic mode the **SYNC OUT** waveform most appropriate for the current main waveform is selected.

For example, `waveform sync` is automatically selected for all continuous standard and arbitrary waveforms, but `trigger` is selected in trigger or gated waveform modes. The automatic selection will be mentioned in each of the appropriate main waveform mode sections and a full table is given in the appendix.

The automatic selection can still be changed manually by the `src` soft-key even when `auto` mode has been selected but the selection will immediately revert to the automatic choice as soon as any relevant parameter (for example, main waveform frequency or amplitude) is adjusted. You must select `manual` with the `mode` soft-key for a source other than the automatic choice to remain set. The `auto` selection will generally set the most frequently used signal, for example `waveform sync` for all continuous main waveforms, but you will need to use `manual` for any special requirements, such as position markers on arbitrary waveforms.

Chapter 6

Sweep Operation

Title	Page
General.....	6-2
Principles of Sweep Operation	6-2
Connections for Sweep Operation.....	6-2
Setting sweep parameters.....	6-2
Sweep Range	6-3
Sweep Time	6-3
Sweep Type	6-4
Sweep Spacing.....	6-5
Sweep Marker.....	6-5
Sweep Hold	6-5

General

Principles of Sweep Operation

All standard and arbitrary waveforms can be swept with the exception of pulse, pulse-train and sequence. During sweep all waveforms are generated in DDS mode because this offers the significant advantage of phase-continuous sweeps over a very wide frequency range (up to $10^{10}:1$). However, it must be remembered that the frequency is actually stepped, not truly linearly swept, and thought needs to be given as to what the instrument is actually doing when using extreme combinations of sweep range and time.

For DDS operation during sweep all waveforms must be 4096 points in length; this is the natural length for standard waveforms but all arbitrary waveforms are expanded or condensed in software to 4096 points when Sweep is turned on. This does not affect the original data.

Sweep mode is turned on and off either by the `on` or `off` soft key on the `SWEEP SETUP` screen accessed by pressing the **SWEEP** front panel key, or by the `sweep` soft key on the `MODE` screen. In multi-channel instruments two or more channels can be swept simultaneously.

When sweep is turned on the software creates a table of 2000 frequencies between, and including, the specified start and stop values. Because any frequency used in sweep mode must be one of the tabled values, the centre frequency displayed (see *Sweep range* below) may not be the exact midpoint and markers (see *Sweep marker* below) may not be exactly at the programmed frequency. The frequency resolution of the steps will be particularly coarse with wide sweeps.

Connections for Sweep Operation.

Sweeps are generally used with an oscilloscope or hard-copy device to investigate the frequency response of a circuit. The **MAIN OUT** is connected to the circuit input and the circuit output is connected to an oscilloscope or, for slow sweeps, a recorder.

An oscilloscope or recorder can be triggered by connecting its trigger input to the generator's **SYNC OUT**, which defaults to `sweep sync` when sweep is turned on. The sweep sync signal goes high at the start of sweep and remains high for the duration of the first frequency step.

To show a marker on the display instrument the **SYNC OUT** can be set to additionally output a marker pulse. See *Sweep marker* below for setting the marker frequency.

For triggered sweeps, a trigger signal may be provided by any of the possible trigger sources, i.e. internal, external, manual or remote.

The generator does not provide a ramp output for use with X-Y displays or recorders.

Setting sweep parameters

Pressing the **SWEEP** key (or the sweep set-up soft key on the `MODE` screen) displays the `SWEEP SETUP` screen:

```

SWEEP SETUP:      off↕
↕range...        type...↕
↕time...         spacing...↕
                                   marker...↕
  
```

Menus for setting up the range, time (sweep rate), type (continuous, triggered, etc.) spacing (lin/log) and marker position are all accessed from this screen using the appropriate soft key. Sweep mode itself is turned on and off with alternate presses of the `on/off` soft key; sweep can also be turned on by the `sweep` soft key on the **MODE** screen.

On multi-channel instruments two or more channels can be swept at once. The channels to be swept are set on or off by selecting them in turn with the appropriate **SETUP** key and then using the `on/off` soft key of the **SWEEP SETUP** screen.

On all the following menus, pressing the `done` soft key returns the display to this **SWEEP SETUP** screen.

Sweep Range

Pressing the `range...` soft key calls the **SWEEP RANGE** screen.

```
SWEEP RANGE:
◆start 100.0    kHz
◇stop  10.00   MHz
◇centr/span    done◇
```

The maximum sweep range for all waveforms is 1 mHz to 40 MHz, including triangle, ramp and square wave (which have different limits in unswept operation).

Sweep range can be defined by start and stop frequencies or in terms of a centre frequency and span. `start` and `stop` soft keys permit the two end points of the sweep to be set directly from the keyboard or by using the rotary control. The start frequency must be lower than the stop frequency (but see *Sweep type* below for selecting sweep direction).

Pressing the `centr/span` soft key changes the screen to permit entry in terms of centre frequency and sweep span about that frequency; pressing the `start/stop` soft key on that screen returns the display to the start and stop frequency form of entry.

Note that when the sweep is displayed in terms of centre frequency and span the span will always be the exact difference between start and stop frequencies but the centre frequency shown will be that of the frequency step nearest the true centre frequency, as described above.

Sweep Time

Pressing the `time...` soft key calls the **SWEEP TIME** screen.

```
SWEEP TIME:
  0.010 sec
                        done◇
```

The sweep time can be set from 1 ms to 999 s with 4 digit resolution by direct keyboard entry or by using the rotary control.

Sweep Type

Pressing the `type...` soft key calls the `SWEEP TYPE` screen.

```

SWEEP TYPE:
♦continuous
♦direction: up
♦sync: on      done♦

```

This screen is used to set the sweep mode (`continuous`; `triggered`; `trig'd`, `hold/reset`) and the sweep direction.

Successive presses of the direction soft key select one of the following sweep directions:

<code>up</code>	start frequency to stop frequency.
<code>down</code>	stop frequency to start frequency.
<code>up/down</code>	start frequency to stop frequency and back to start frequency.
<code>down/up</code>	stop frequency to start frequency and back to stop frequency.

The total sweep time is always that set on the `SWEEP TIME` screen, i.e. for `up/down` and `down/up` operation the sweep time in each direction is half the total. Similarly the total number of steps is the same for all choices, i.e. there will be half the number of steps in each direction for `up/down` and `down/up` operation. In the sweep mode descriptions which follow the direction is assumed to be `up` but all modes can be used with all sweep directions.

In `continuous` mode the generator sweeps continuously between the start and stop frequencies, triggered repetitively by an internal trigger generator whose frequency is determined by the sweep time setting. At the stop frequency the generator resets to the start frequency and begins a new sweep. If `sync` is set to `on` (the default) the generator steps instantaneously from the stop frequency to zero frequency (i.e. it does not dwell at the stop frequency for the full step interval) and then starts the next sweep from the first point of the waveform, synchronized to the internally generated trigger signal.

This is useful because the sweep always starts from the same point in the waveform but the waveform discontinuity can be undesirable in some circumstances, for example filter evaluation. With `sync` set to `off` the frequency steps directly and phase continuously from the stop frequency to the start frequency (after dwelling at the stop frequency for the full step interval) but is not synchronized with the software generated trigger signal.

In `triggered` mode the generator holds the output at the start frequency until it recognizes a trigger. When triggered, the frequency sweeps to the stop frequency, resets, and awaits the next trigger. If `sync` is set to `on` the frequency resets to zero frequency (i.e. no waveform) and starts a new sweep at the first point of the waveform when the next trigger is recognized. If `sync` is set to `off` the waveform resets to the start frequency and runs at that frequency until the next trigger initiates a new sweep.

In `trig'd`, `hold/reset` mode the generator holds the output at the start frequency until it recognizes a trigger; when triggered, the frequency sweeps to the stop frequency and holds. At the next trigger the output is reset to the start frequency where it is held until the next sweep is initiated by a further trigger. If `sync` is set to `off` the output operates exactly as described above; if `sync` is set to `on` the output resets to zero frequency (i.e. no waveform) and starts a new sweep at the first point of the waveform.

For triggered sweeps a trigger signal may be provided by any of the possible trigger sources, i.e. internal, external, manual or remote.

Sweep Spacing

Pressing the `spacing...` soft key on the `SWEEP SETUP` screen calls the `SWEEP SPACING` screen.

```
SWEEP SPACING:
◆logarithmic
◇linear
done◇
```

With `linear` selected the sweep changes the frequency at a linear rate; with `logarithmic` selected the sweep spends an equal time in each frequency decade.

Sweep Marker

A sweep marker pulse is also available from the **SYNC OUT** socket when `sweep sync` (the default condition) is selected. The marker pulse is differentiated from the sweep sync pulse by being approximately half the amplitude of the sync pulse; this permits the trigger level of the display oscilloscope to be adjusted for the sweep sync pulse without additionally triggering on the marker pulse.

The marker pulse frequency is set from the `SWEEP MARKER FREQ` menu, called by pressing the `marker...` soft key on the `SWEEP SETUP` screen.

```
SWEEP MARKER FREQ:
programm: 5.000 MHz
actual: 4.977 MHz
done◇
```

A new marker frequency can be programmed directly from the keyboard or by using the rotary control and cursor keys. Note that the marker frequency can only be one of the values in the sweep frequency table; any value in the sweep range can be entered but the value used will be the nearest frequency in the table. When sweep is turned on, the actual marker frequency is shown in the non-editable field below the programmed frequency. For the default sweep setting of 100 kHz to 10 MHz in 50 ms, the actual frequency of a 5 MHz marker is 4.998 MHz.

The marker duration is the sweep time divided by 2000, i.e. the dwell time at a single frequency step.

To avoid displaying a sweep marker, the marker frequency is simply set to a value outside the current sweep frequency range.

Sweep Hold

The sweep can be held and restarted at any time at or from its current frequency by alternate presses of the **MAN HOLD** key or remote command.

Chapter 7

Triggered Burst and Gate

Title	Page
General.....	7-2
Internal Trigger Generator.....	7-2
External Trigger Input.....	7-2
Adjacent Channel Trigger Output.....	7-3
Triggered Burst.....	7-3
Trigger Source.....	7-4
Trigger Edge.....	7-4
Burst Count.....	7-4
Start Phase.....	7-5
Manual Initialization of Inter-Channel Triggering.....	7-5
Gated mode.....	7-6
Gate Source.....	7-6
Gate Polarity.....	7-6
Start Phase.....	7-6
Sync Out in Triggered Burst and Gated Modes.....	7-7

General

Triggered burst and gated modes are selected from the `MODE` screen, called by the **MODE** key, as alternatives to the default continuous mode.

```
MODE:                off↕  
↕continuous  
↕gated              setup...↕  
↕triggered         setup...↕
```

In triggered burst mode a defined number of cycles are generated following each trigger event. This mode is edge triggered.

In gated mode the generator runs whenever the gating signal is true. This mode is level sensitive.

Triggered burst mode and gated mode can be controlled by either the internal trigger generator, an external trigger input, by the front panel **MAN TRIG** key or by remote control.

In both modes the start phase, i.e. the starting point on the waveform cycle, can be specified.

Internal Trigger Generator

The period of the internal trigger generator is set with the `period` soft key on the `TRIGGER IN` set-up screen called by the **TRIG IN** key.

```
↕source: int  force↕  
↕slope:  positive  
↕level:  +1.4 V  
↕period: 1.00ms
```

The internal trigger generator divides down a crystal oscillator to produce a 1:1 square wave with a period from 0.01 ms (100 kHz) to 200 s (0.005 Hz). Generator period entries that cannot be exactly set are accepted and rounded up to the nearest available value, so that for example 0.109 ms is rounded to 0.11 ms.

When triggered burst or gated modes are selected the **SYNC OUT** source automatically defaults to `trigger` which is the output of the internal trigger generator when internal triggering or gating is specified.

In triggered burst mode the selected edge of each cycle of the trigger generator is used to initiate a burst; the interval between bursts is therefore 0.01 ms to 200 s as set by the generator period.

In gated mode the output of the main generator is gated on whilst the internal trigger generator output is true; the duration of the gate is therefore 0.005 ms to 100 s in step with trigger generator periods of 0.01 ms to 200 s.

External Trigger Input

External trigger or gate signals are applied to the front panel **TRIG IN** socket which has a variable threshold level set using the `level` soft-key; the level can be set from -5.0 V

to +5.0 V by direct keyboard entry or by using the rotary control. In triggered burst mode the input is edge sensitive; the selected edge of each external trigger initiates the specified burst. In gated mode the input is level sensitive; the output of the main generator is on whilst the gate signal is true.

The minimum pulse width that can be used with **TRIG IN** in triggered burst and gated modes is 50 ns and the maximum repetition rate is 1 MHz. The maximum signal level that can be applied without damage is ± 10 V.

When triggered burst or gated mode is selected the **SYNC OUT** source automatically defaults to `trigger`, which is always a positive-edged version of the external trigger or gate signal when external triggering or gating is specified.

Adjacent Channel Trigger Output

On multi-channel instruments the trigger out signal of an adjacent channel can be used as the control signal for a triggered burst. The channel numbering 'wraps round', i.e. channels 1 and 3 are obviously adjacent to channel 2 but so are channels 2 and 4 adjacent to channel 1..

The source of the trigger out signal is selected by the `source` soft-key on the **TRIGGER OUT** screen called by the **TRIG IN** key.

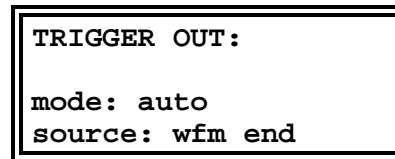

The **TRIGGER OUT** choices are as follows:

- `wfm end`: Waveform end; a positive-going pulse coincident with the end of a waveform cycle (and the start of the next).
- `pos'n marker`: Position marker; arbitrary waveforms only. Any point(s) on the main waveform may have marker bit(s) set high or low. No output if selected for a standard waveform.
- `seq sync`: Sequence sync; a positive-going pulse coincident with the end of a waveform sequence.
- `burst done`: A positive-going pulse coincident with the end of the last cycle of a burst.

The default choice is `wfm end` except when the channel is running a sequence in which case it becomes `seq sync`. To set the trigger out to anything other than its default it is necessary to change the mode from `auto` to `manual` using the `mode` soft key.

Trigger out is an internal signal but, as with the other trigger sources, a positive-edged version is available at the triggered channel's **SYNC OUT** with its default source of `trigger` selected.

Triggered Burst

Triggered burst mode is turned on with the `triggered` soft key on the **MODE** screen. The `setup...` soft key on this screen accesses the **TRIGGER/GATE SETUP**

screen on which the burst count and start phase are set. The other trigger parameters are set on the TRIGGER IN set-up screen called by pressing the **TRIG IN** key.

```

◆source: int force◇
◇slope: positive
◇level: +1.4 V
◇period: 1.00ms

```

Trigger Source

The trigger source can be selected with the source soft key on the TRIGGER IN set-up screen to be `int`, `ext`, `man` or an adjacent channel.

With `int` selected the internal trigger generator is used to initiate a burst; this generator is set up as described in the previous section.

With `ext` selected the specified edge of the signal at **TRIG IN** is used to initiate a burst.

With `chan x` selected (multi-channel instruments only) the trigger out signal from an adjacent channel is used to initiate a burst; the source of the trigger out signal on that channel `x` is set up as described in *Adjacent Channel Trigger Output* above.

With `man` selected as the source the only ways to initiate a burst are by pressing the **MAN TRIG** key or by issuing a remote command. In multi-channel instruments pressing **MAN TRIG** will trigger all those channels for which `man` has been selected as the source.

Trigger Edge

The `slope` soft key is used to select the edge (`positive` or `negative`) of the external trigger signal used to initiate a burst. The default setting of `positive` should be used for triggering by the internal trigger generator or an adjacent channel's trigger out.

Note that the trigger signal from **SYNC OUT**, used for synchronizing the display of a triggered burst on an oscilloscope for example, is always positive-going at the start of the burst.

Burst Count

The number of complete cycles in each burst following the trigger is set from the TRIGGER/GATE SETUP screen called by pressing `setup` on the MODE screen.

```

TRIGGER/GATE SETUP:
◆burst cnt: 0000001
◇phase: +000.0°
(actual: +000.0°)

```

The required count can be set by pressing the `burst cnt` soft key followed by direct entries from the keyboard or by using the rotary control. The maximum number of waveform cycles that can be counted is 1,048,575 ($2^{20}-1$)

Start Phase

The start phase, i.e. the point on the waveform cycle at which the burst starts, can be selected by pressing the `phase` soft key followed by direct entries from the keyboard or by using the rotary control. Since the waveform cycle is always completed at the end of the burst the start phase is also the stop phase.

The phase can be set with a precision of 0.1 ° but the actual resolution is limited with some waveforms and at certain waveform frequencies as detailed below. To indicate when this is the case the actual phase is shown in brackets as a non-editable field below the programmed value.

To achieve start phase precision all waveforms are run in clock synthesis mode, i.e. as if they were arbitrary waveforms, when triggered burst is specified; this limits the frequency resolution to 8 digits for all waveforms although the normally DDS generated waveforms are still entered with 10 digit precision. Sine/cosine/haversine/etc. waveforms are created as if they were arbitrary waveforms with the first point of the waveform exactly at the start phase; each time the phase or frequency is changed the waveform is recalculated. This can cause a slight lag if the parameters are changed quickly using the rotary knob.

The phase resolution of true arbitrary waveforms is limited by the waveform length since the maximum resolution is 1 clock; thus waveforms with a length greater than 3600 points will have a resolution of 0.1 ° but below this number of points the maximum resolution becomes 360 ° divided by the number of points.

Square waves, pulses, pulse trains and sequences have no start phase adjustment; phase is fixed at 0 °.

A summary of start phase capabilities in triggered burst mode is shown in the table below:

<u>Waveform</u>	<u>Max waveform frequency</u>	<u>Phase control range, resolution</u>
Sine, cosine, haversine and havercosine	2.5 MHz	±360 °, 0.1 °
Square	2.5 MHz	0 ° only
Triangle	500 kHz	±360 °, 0.1 °
Ramp	500 kHz	±360 °, 0.1 °
Sin(x)/x	500 kHz	±360 °, 0.1 °
Pulse and pulse train	25 MHz	0 ° only
Arbitrary	100 Msamples/s clock	±360 °, 360 ÷ length or 0.1 °
Sequence	100 Msamples/s clock	0 ° only

Manual Initialization of Inter-Channel Triggering

If a multi-channel instrument is set up such that all channels are triggered by an adjacent one it is possible to have a stable condition where all channels are waiting for a trigger and the sequence of triggered bursts never starts. To overcome this problem any channel can be triggered manually and independently using the `force` soft-key on that channel's `TRIGGER IN` screen. Select the channel to start the sequence with the appropriate **SETUP** key, select the `TRIGGER IN` screen with the **TRIG IN** key and press the `force` soft key.

Gated mode

Gated mode is turned on with the `gated` soft key on the `MODE` screen. The `setup...` soft key on this screen accesses the `TRIGGER/GATE SETUP` screen on which the start phase is set. The other parameters associated with gated mode are set on the `TRIGGER IN` set-up screen called by pressing the **TRIG IN** key.

```

◆source: int force◆
◆slope:  positive
◆level:  +1.4 V
◆period: 1.00ms

```

Gate Source

The gate signal source can be selected with the `source` soft key on the `TRIGGER IN` set-up screen to be `int`, `ext` or an adjacent channel.

With `int` selected the internal trigger generator is used to gate the waveform; the duration of the gate is half the generator period, (see *Internal Trigger Generator* above).

With `ext` selected the gate duration is from the threshold level set on the specified edge of the signal at **TRIG IN** until the same level on the opposite edge; the threshold and edge are set using the `level` and `slope` soft-keys respectively.

With `chan x` selected the trigger out signal from the adjacent channel `x` is used to gate the waveform; the source of the trigger out signal on that channel `x` is set up as described in *Adjacent Channel Trigger Output* above.

Gate Polarity

If `slope` on the `TRIGGER IN` set-up screen is set to `positive` the gate will open at the threshold on the rising edge and close on the threshold of the falling edge of an external gating signal, i.e. the gate signal is true when the **TRIG IN** signal is high. If `slope` is set `negative` the gate signal is true when the **TRIG IN** signal is low. The default setting of `positive` should be used for gating with the internal trigger generator or an adjacent channel's trigger out.

Start Phase

Press `setup...` on the `MODE` screen to access the `TRIGGER/GATE SETUP` screen on which the start phase can be set.

```

TRIGGER/GATE SETUP:
◆BURST CNT: 000001
◆PHASE:    +000.0°
(actual: +000.0°)

```

The start phase, i.e. the point on the waveform cycle at which the gated waveform starts, can be selected by pressing the `phase` soft key followed by direct entries from the keyboard, or by using the rotary control. Since the waveform cycle is always completed at the end of the gated period the start phase is also the stop phase.

The phase can be set with a precision of 0.1° but the actual resolution is limited with some waveforms and at certain waveform frequencies as detailed below. To indicate when this is the case the actual phase is shown in brackets as a non-editable field below the programmed value.

To achieve start phase precision all waveforms are run in clock synthesis mode, i.e. as if they were arbitrary waveforms, when gated mode is specified; this limits actual frequency resolution to 8 digits for all waveforms although the normally DDS generated waveforms are still entered with 10-digit precision. Sine/cosine/haversine etc. waveforms are created as if they were arbitrary waveforms with the first point of the waveform exactly at the start phase; each time the phase or frequency is changed the waveform is recalculated. This can cause a slight lag if the parameters are changed quickly using the rotary knob.

The phase resolution of true arbitrary waveforms is limited by the waveform length since the maximum resolution is 1 clock; thus waveforms with a length greater than 3600 points will have a resolution of 0.1° but below this number of points the maximum resolution becomes 360° divided by the number of points.

Square waves, pulse, pulse trains and sequences have no start phase adjustment; phase is fixed at 0° . Refer to the table in the *Triggered Burst* section above for a summary of start phase capabilities.

Sync Out in Triggered Burst and Gated Modes

When triggered burst or gated modes are selected the **SYNC OUT** source automatically defaults to `trigger`; this is a positive-edged signal synchronized to the actual trigger used whether internal (from the internal trigger generator or an adjacent channel) or external of either polarity.

Alternatively, **SYNC OUT** can be set to `burst done` on the SYNC OUT set-up screen; in this case it provides a signal which is low while the waveform is running and high at all other times.

Chapter 8

Tone Mode

Title	Page
Introduction.....	8-2
Tone Frequency	8-2
Tone Type.....	8-2
Tone Switching Source.....	8-3
DTMF Testing With Two Sources	8-3

Introduction

In tone mode the output is stepped through a user-defined list of up to 16 frequencies under the control of the signal set by the `source` soft key on the `TRIGGER IN` set-up screen. This signal can be the internal trigger generator, an external trigger input, the front panel **MAN TRIG** key or a remote command. On multi-channel instruments the control signal can also be the trigger out from an adjacent channel.

All standard and arbitrary waveforms can be used in tone mode with the exception of pulse, pulse-train and sequence. All waveforms used in tone mode are generated in DDS mode for fast phase-continuous switching between frequencies. For DDS operation all waveforms must be 4096 points in length; this is the natural length for standard waveforms but all arbitrary waveforms are expanded or condensed in software to 4096 points when the tone list is built. This does not affect the original data.

Because DDS mode is used the frequency range for all waveforms is 1 mHz to 40 MHz in tone mode, including triangle, ramp and square wave (which have different limits in continuous operation).

Tone Frequency

Press the `tone setup...` soft key on the `MODE` screen, called by pressing the **MODE** key, to get the `TONE` set-up screen:

```
TONE type:      trig◇
◇2.000000 kHz #2
◆3.000000 kHz  del◇
◇end of list #4
```

Each frequency in the list can be changed by pressing the appropriate soft key and entering the new value from the keyboard. The selected frequency can be deleted from the list by pressing the `del` (delete) soft key. Additional frequencies can be added to the end of the list by selecting `end of list` with the appropriate soft key and entering the new frequency from the keyboard.

The whole list can be scrolled back and forward through the display using the rotary control.

Tone Type

The `type` soft key on the `TONE` set-up screen permits three types of tone switching to be specified.

With `type` set to `trig` the frequency changes after each occurrence of the signal edge specified in the `source` and `slope` fields on the `TRIGGER IN` screen but only after completing the last cycle of the current frequency.

With `type` set to `gate` the frequency changes when the signal specified in the `source` field goes to the level specified in the `slope` field on the `TRIGGER IN` screen and continues until the level changes again at which point the current cycle is completed; the output is then gated off until the next occurrence of the gating signal, when the next frequency in the list is gated on.

The difference between triggered and gated tone changes is therefore that in triggered mode the signal changes phase-continuously from one frequency to the next at the waveform zero-crossing point immediately after the trigger signal whereas in gated mode

there can be an off period between successive frequencies whilst the gate signal is not true.

With `type` set to `fsk` the frequency changes instantaneously (and phase-continuously) at each occurrence of the signal edge specified in the `source` and `slope` fields on the TRIGGER IN screen without completing the current waveform cycle; this is true FSK (frequency shift keying) tone switching.

The maximum recommended tone frequencies and trigger/gate switching frequencies for the three modes are as follows:

gate	Maximum tone frequency 50 kHz; maximum switching frequency less than lowest tone frequency.
trig	Maximum tone frequency 50 kHz; maximum switching frequency 1 MHz.
fsk	Maximum tone frequency 1 MHz; maximum switching frequency 1 MHz.

The drawings below demonstrate the differences between trigger, gate and FSK tone switching for a list of 2 frequencies switched by a square wave (positive slope specified on the TRIGGER IN set-up).

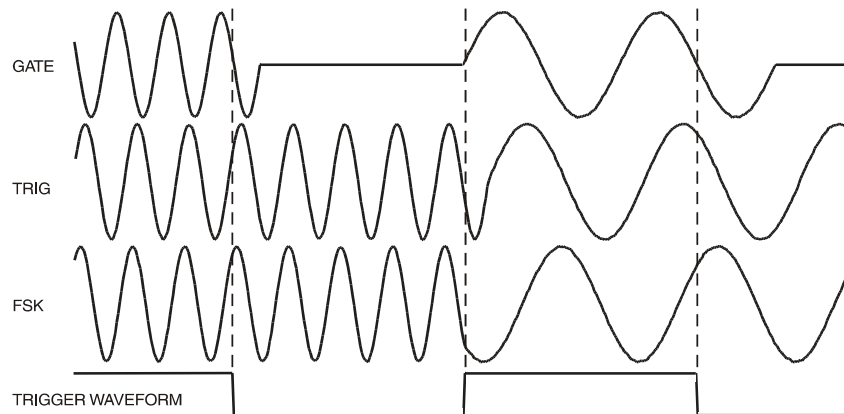

Figure 8-1. Tone Waveform Types

shc0007f.emf

Tone Switching Source

The signal which controls the frequency switching is that set by the `source` soft key on the TRIGGER IN set-up screen. The `slope` field on the same screen sets the active polarity of that signal; when set to `positive` the rising edge of the trigger signal is active or the high level of the gating signal is true, and the opposite for a negative setting. The signal selections on the `source` soft key are the internal trigger generator, an external trigger input, the front panel **MAN TRIG** key, a remote command or (in the case of multi-channel instruments) the trigger out from an adjacent channel. A full explanation for each of these can be found in chapter 7, *Triggered Burst and Gate*.

DTMF Testing With Two Sources

An important use of tone mode is DTMF (Dual Tone Multiple Frequency) testing in which two channels are set up with equal length lists of different frequencies, triggered from a common signal. The outputs are summed together using the internal sum facility (see chapter 12, *Sum*). DTMF testing generally uses sine waves in the frequency range 600 Hz to 1.6 kHz.

It is also possible to set up DTMF testing using two single channel instruments triggered by a common external signal and summed using the external **SUM** capability.

Chapter 9

Arbitrary Waveform Generation

Title	Page
Introduction.....	9-2
Arbitrary Waveform Terms.....	9-2
Principles of Arbitrary Waveform Creation and Modification.....	9-2
Selecting and Outputting Arbitrary Waveforms	9-3
Creating New Waveforms	9-4
Create Blank Waveform.....	9-4
Create Waveform Copy.....	9-4
Modifying Arbitrary Waveforms.....	9-5
Resize Waveform	9-5
Rename Waveform.....	9-6
Waveform Info	9-6
Delete Waveform	9-6
Edit Waveform	9-7
Point Edit.....	9-7
Line Edit.....	9-7
Wave Insert	9-8
Block Copy	9-8
Waveform Amplitude.....	9-9
Waveform Offset.....	9-10
Wave Invert.....	9-10
Position Markers	9-10
Arbitrary Waveform Sequence	9-11
Sequence Set-Up	9-12
Frequency and Amplitude Control with Arbitrary Waveforms	9-13
Frequency	9-13
Amplitude.....	9-15
Sync Out Settings with Arbitrary Waveforms	9-15
Waveform Hold in Arbitrary Mode	9-15
Output Filter Setting	9-16

Introduction

Arbitrary (arb) waveforms are generated by sequentially addressing the RAM containing the waveform data with the arbitrary clock. The frequency of the arb waveform is determined both by the arb clock and the total number of data points in the cycle.

In this instrument an arb waveform can have up to 1,048,576 horizontal points. The vertical range is -2048 to +2047, corresponding to a maximum peak-to-peak output of 20 Volts. Up to 500 waveforms can be stored on the memory card and each given a name; the number that can be stored depends on the number of points in each waveform and the size of the memory card.

Arb waveforms can be created using basic front panel editing capabilities (particularly useful for modifying existing standard or arb waveforms) or by using waveform design software that enables the user to create waveforms from mathematical expressions, from combinations of other waveforms, or freehand; details are given in appendix E.

Arbitrary Waveform Terms

The following terms are used in describing arb waveforms:

Horizontal size:	The number of horizontal points is the time component of the waveform. The minimum size is 8 points and the maximum is 1,048,576 points.
Waveform address:	Each horizontal point on an arb waveform has a unique address. Addresses always start at 0000, thus the end address is always one less than the horizontal size.
Arb frequency:	The arb frequency is the clock rate of the data RAM address counters and has a range of 0.1 Hz to 100 MHz (internal clock) or dc to 50 MHz (external clock) on this instrument.
Waveform frequency:	The waveform frequency depends on both the arb frequency and horizontal size. For example a 1000 point waveform clocked at an arb frequency of 100 MHz has a waveform frequency of $100\text{e}6$ divided by 1000 = 100 kHz.
Data value:	Each point in the waveform has an amplitude value in the range -2048 to +2047.
Waveform amplitude:	When playing arb waveforms the maximum output amplitude will depend on both the range of data values and the output amplitude setting. A waveform which includes data values of -2048 and +2047 will produce a maximum output which is 100 % of the programmed peak-to-peak amplitude; if the maximum range of the data values is only -1024 to +1023, for example, the maximum output will only be 50% of the programmed level.

Principles of Arbitrary Waveform Creation and Modification

Creating arb waveforms with the instrument alone consists of two main steps:

1. Creating a new blank waveform, or a copy of an existing one, and giving it a size and a name
2. Modifying that waveform using the various editing capabilities to get exactly the waveform required.

These steps are fully described in the *Creating New Waveforms* and *Modifying Arbitrary Waveforms* sections which follow.

Waveform creation using waveform design software also consists of two steps:

1. Creating the waveform using the software on a PC.
2. Downloading the waveform directly to the memory card (using the USB-connected card reader/writer) and inserting the card into the instrument. Alternatively, the waveform can be downloaded to the generator via the RS232, GPIB or USB interfaces. This process is described in chapter 14 and Appendix E.

Modification of an arb waveform that is currently running on the instrument is subject to certain constraints; these are mentioned in the appropriate individual sections and warning or error messages will be given if illegal operations are attempted. As a general rule, modification of a current waveform should only be implemented with the generator running in **continuous** mode.

Selecting and Outputting Arbitrary Waveforms

With a memory card plugged in, press the **ARB** key to see the list of all the arbitrary waveforms held on the card.

ARBITRARY WAVEFORMS	
◇WFM1	4096
◇WFM2	11000
◇SPIKE100	100000

If no card is fitted the display will show the message
Please insert a memory card.

If there are no waveforms on the card the message will be
There are no arb waveforms available.

If the generator is switched on without a card fitted, and the power-on conditions have been set to recall power-down set-up which included an arb waveform, an error message
File <name> not found, load std square
is temporarily displayed and the generator defaults to a square wave output.

With a card plugged in the rotary knob or cursor keys can be used to scroll the full list backwards and forwards through the display. Select the required waveform by pressing the associated soft key.

To make it easier to find a particular waveform in a long list it is recommended that the waveforms on the card are first sorted into alphabetical order using the sort facility on the MEMORY CARD screen accessed from the UTILITY menu (refer to chapter 14 *Memory Card*).

Note that the last used arb waveform can also be selected to run from the STANDARD WAVEFORMS screen, accessed by pressing the **STD** key, by pressing the arb soft key in the STANDARD WAVEFORMS list; this makes it easier to switch quickly between a true standard waveform (e.g. sine) and a particular arb.

Creating New Waveforms

Pressing the **CREATE** key calls the `CREATE NEW WAVEFORM` screen.

```
CREATE NEW WAVEFORM
◇create blank...
◇create from copy...
```

Create Blank Waveform

Pressing the `create blank...` soft key calls the menu:

```
◆create:  "WFM1  "
◇size:    0001024
◇cancel   create◇
```

The top line contains the user-defined waveform name which can be up to 8 characters long. The instrument allocates a default name of `WFM<n>` starting at `WFM1`; the name can be edited by selecting the appropriate character position with the cursor keys and then setting the character with the rotary control which scrolls through all alphanumeric characters in sequence.

Pressing the `size` soft key permits the waveform length to be entered directly from the keyboard or by using the rotary control and cursor keys; the default size is 1024. The minimum size is 8 and the maximum 1,048,576; appropriate warnings are given if attempts are made to set a waveform size outside these limits.

This menu can be exited either by pressing the `cancel` soft key which keeps the name but does not allocate the memory space, or by pressing the `create` soft key which builds a “blank” waveform (i.e. one in which all the data values are zero) and returns the screen to the `ARBITRARY WAVEFORMS` list.

Create Waveform Copy

Pressing the `create from copy...` soft key calls the following menu:

```
◆create:  "WFM1  "
◇from:    sine
◇size:    0001024
◇cancel   create◇
```

The user-defined name and waveform size can be entered after pressing the `create` and `size` soft keys respectively, exactly as described in the previous section.

The source waveform which is to be copied can be selected by the `from` soft key; repeated presses of the soft key, cursor keys or using the rotary control will scroll through the list of all the available waveforms, including any other arbitrary waveforms already created.

The horizontal size of the waveform being copied does not have to be the same as the waveform being created. When the waveform is copied, by pressing the `create` soft key, the software compresses or expands the source waveform to create the copy. When the source is expanded the copy has additional interpolated points; when the source is compressed, significant waveform data may be lost, particularly from arb waveforms with narrow spikes if the compression ratio is large.

The menu can be exited by pressing the `cancel` soft key, which keeps the name but does not implement the copy, or by pressing the `create` soft key, which makes the copy and returns the screen to the `ARBITRARY WAVEFORMS` list.

Modifying Arbitrary Waveforms

Pressing the **MODIFY** front panel key calls the `MODIFY` screen.

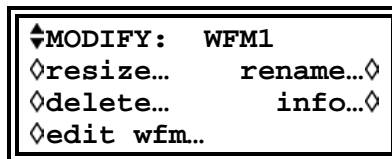

This screen gives access to a number of menus which permit the selected waveform to be resized, renamed, edited, etc. The arb waveform to be modified is selected using the rotary control or cursor keys to step through all possible choices; the current selection is displayed on the top line beside `MODIFY`.

Resize Waveform

Pressing the `resize...` soft key on the `MODIFY` screen calls the `Resize` screen.

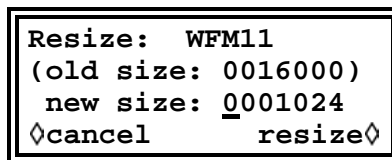

`Resize` changes the number of points in the waveform; the new size can be larger or smaller than the old size. When the new size is larger, the software adds additional interpolated points. When the size is smaller, points are removed. Reducing the waveform size may cause the waveform to lose significant data.

Enter the size required by pressing the `new size` soft key followed by direct entries from the keyboard or by using the rotary control. `Resize` is implemented by pressing the `resize` soft key or aborted by pressing the `cancel` soft key; both return the display to the `MODIFY` screen. There is no "undo" facility for `resize`.

Rename Waveform

Pressing the `rename...` soft key on the `MODIFY` screen calls the `Rename` screen:

```

Rename:  WFM1
        as: "WFM2  "
◇cancel          rename◇
  
```

The new name can be entered below the original by selecting the appropriate character position with the cursor keys and then setting the character with the rotary control which scrolls through all the alphanumeric characters in sequence. The name can be up to 8 characters long.

Return to the `MODIFY` screen by pressing `rename` (which implements the new name) or `cancel`.

Waveform Info

Pressing the `info...` soft key on the `MODIFY` screen calls the `info` screen.

```

Info WFM1          exit◇
length:           1024
chan:
seq:
  
```

The screen gives the name of the waveform, its length and the channels (in multi-channel versions of the generator) and sequences where it is used.

Pressing `exit` returns the display to the `MODIFY` screen.

Delete Waveform

Pressing the `delete...` soft key displays a request for confirmation that the selected waveform is to be deleted from the memory card:

```

Delete waveform
  "WFM1  "
    ?
◇cancel          delete◇
  
```

Confirm deletion by pressing the `delete` soft key which will return the display to the `MODIFY` screen with the next arb waveform automatically selected; `cancel` aborts the deletion.

Edit Waveform

Pressing the `edit wfm...` soft key calls the `EDIT FUNCTIONS` menu:

```

EDIT FUNCTIONS:
◊point edit...
◊line draw...
◊wave insert...
```

This menu provides functions which permit the waveform to be edited point-by-point (`point edit`), by drawing lines between two points (`line draw`) or by inserting all or part of an existing waveform into the waveform being edited (`wave insert`). In addition, sections of the waveform can be selected and their peak-to-peak level changed using wave amplitude, or baseline changed using wave offset. Sections of the waveform can be copied into itself (`block copy`) and position markers for use at **SYNC OUT** can also be defined.

Pressing the `exit` soft key on any of these edit screens will return the display to the `EDIT FUNCTIONS` menu.

Point Edit

Press the `point edit...` soft key to call the `POINT EDIT` screen:

```

POINT EDIT  WFM1
  (addrs , value)
◊ (0000512, +0500)◊
◊exit      next point◊
```

To modify a point, press the `addrs` soft key and enter the address directly from the keyboard or by using the rotary control; the current data value will be displayed to the right of the address. To change the value press `value` and enter the new value directly from keyboard or by using the rotary control. Changing the data value automatically updates the waveform.

Pressing the `next point` soft key automatically advances the address by one point; alternatively press `addrs` to permit address entry from the keyboard or using the rotary control.

Line Edit

Press the `line draw...` soft key to call the `LINE` screen:

```

LINE( addrs ,value)
◊frm(0000512,+0000)◊
◊to (0000750,+0412)◊
◊exit      draw line◊
```

The display shows a `frm` (from) and `to` address which will be the points between which a straight line will be created when the `draw line` soft key is pressed. The

default `frm` address is the first point on the waveform or the point most recently edited if `point edit` has been used. Set the from address and value by pressing the appropriate soft key and making an entry direct from the keyboard or by using the rotary control; repeat for the to address and value.

The line will be drawn between the two selected points when the `draw line` soft key is pressed.

Wave Insert

Pressing `wave insert...` calls the `wave insert` screen:

```

↕WFM1      → WFM2
◇000000 strt0000400◇
◇000512 stop0100000◇
◇exit      insert◇

```

Wave insert places waveforms between programmable start and stop points. Both standard and arbitrary waveforms can be inserted in the new waveform, with the exception of pulse, pulse-train and sequence.

A section of an arbitrary waveform can be inserted, as defined by the left hand `strt` (start) and `stop` addresses (0 and 512 of WFM1 on the screen above); these addresses default to the start and stop of the whole waveform but can be reset to define any section of the waveform. Change the addresses by pressing the appropriate soft key and making entries from the keyboard or using the rotary control. The destination of the selected section of the source waveform in the new waveform is defined by the right hand `strt` (start) and stop addresses. Change the addresses by pressing the appropriate soft key and making entries from the keyboard or using the rotary control.

The insertion is confirmed by pressing the `insert` soft key. If there is a size difference between the two sections of waveform then the software will expand or compress the source to fit the new waveform. Compressing the waveform can cause some significant data to be lost.

To insert sections of the current waveform into itself, see *Block Copy*

Block Copy

Pressing `block copy...` calls the `BLOCK COPY` screen:

```

BLOCK COPY: WFM42
◆start:0000400
◇stop: 0001000 copy◇
◇dest: 0000000 exit◇

```

Block copy allows a section of the current waveform to be inserted within itself. The block to be inserted is defined by the `start` and `stop` addresses. Change the addresses by pressing the appropriate soft key and making entries from the keyboard or using the rotary control.

The destination address for the start of the section is set by pressing the `dest` soft key and entering the address.

Press `copy` to implement the copy. During the two stage block copy process the screen displays the message `processing file - please wait` and shows a progress bar. During the first stage the block to be copied is created as a temporary file with the same name as the main file but with a `$$$` extension; during the second stage the appropriate section of the original file is overwritten and the temporary file is deleted.

Note that if there are not enough waveform points between the destination address and end of waveform to accommodate the copied section, the waveform being copied will simply be truncated. Once copied there is no undo and the original waveform cannot be recovered.

Block copy edit operates on the version of the waveform in the channel currently selected by the channel set-up keys; the effect of the edit can be seen by selecting the waveform to run on that channel. When the block copy is as required it can be saved by pressing the `save` soft-key; the action of saving modifies the waveform in the backup memory and then any other copies of the waveform in other channel memories. Once saved the original waveform cannot be recovered.

Pressing `exit` returns to the `EDIT FUNCTIONS` screen without change.

Waveform Amplitude

Pressing the `wave amplitude` soft key initiates the creation of a temporary copy of the waveform to be edited and calls the `AMPLITUDE` screen:

```

AMPLITUDE:    001.00◆
◆0000000 to 0000123◆
◆undo        set ampl◆
◆save & exit  save◆
```

The waveform amplitude can be changed on a section of the waveform defined by the `start` and `stop` addresses. Set the addresses by pressing the appropriate soft key and making entries directly from the keyboard or using the rotary control.

The data values over the specified section of the waveform can be multiplied by a factor of between 0.01 and 100.0 by making entries in the `AMPLITUDE` field. Press the appropriate soft key and make entries direct from the keyboard or by using the rotary control; the amplitude changes on completion of the entry. Note that entries greater than 1.0 will cause clipping if the waveform already uses the full -2048 to +2047 data value range; the result is, however, still treated as a valid waveform. The original waveform can be restored by pressing the `undo` soft key.

Amplitude edit operates on the version of the waveform in the channel currently selected by the channel set-up keys; the effect of the edit can be seen by selecting the waveform to run on that channel. When the amplitude has been modified as required the new waveform can be saved by pressing the `save` key; once saved the original waveform cannot be recovered.

Pressing `save & exit` returns to the `EDIT FUNCTIONS` screen after the save has been implemented. To exit the `AMPLITUDE` edit without saving changes, press `undo` then `save & exit`.

Waveform Offset

Pressing the `wave offset` soft key initiates the creation of a temporary copy of the waveform to be edited and calls the `WAVE OFFSET` screen.

```

WAVE OFFSET:  +0000◆
◆0000000 to 0000123◆
◆undo      set offset◆
◆save & exit  save◆

```

The waveform offset can be changed on a section of the waveform defined by the `start` and `stop` addresses. Set the addresses by pressing the appropriate soft key and making entries directly from the keyboard or using the rotary control.

The data values over the specified section of the waveform are offset by the value entered in the `WAVE OFFSET` field. Press the appropriate soft key and make entries directly from the keyboard or by using the rotary control. Entries in the range -4096 to +4095 will be accepted; this permits, in the extreme, waveform sections with values at the -2048 limit to be offset to the opposite limit of +2047. Warnings are given when the offset causes clipping but the entry is still accepted. The original waveform can be restored by pressing the `undo` soft key.

Offset edit operates on the version of the waveform in the channel currently selected by the channel set-up keys; the effect of the edit can be seen by selecting the waveform to run on that channel. When the offset has been modified as required the new waveform can be saved by pressing the `save` key; once saved the original waveform cannot be recovered.

Pressing `save & exit` returns to the `EDIT FUNCTIONS` screen after the save has been implemented. To exit the `WAVE OFFSET` edit without saving changes, press `undo` then `save & exit`.

Wave Invert

Pressing the `wave invert` soft key calls the `INVERT` screen:

```

INVERT:      WFM1
◆start adrs: 0000512
◆stop adrs:  0000750
◆exit        invert◆

```

The waveform or a section of it defined by the `start` and `stop` addresses can be inverted. Set the addresses by pressing the appropriate soft key and making entries directly from the keyboard or using the rotary control.

The data values over the specified section of the waveform are inverted about 0000 each time the `invert` soft key is pressed.

Press `exit` to return to the `EDIT FUNCTIONS` screen.

Position Markers

Pressing the `position markers...` soft key calls the `POSITION MARKER EDIT` screen:

```

POSITION MARKER EDIT
↕ads: 0000000 <0>↕
↕patterns...
↕exit      clear all↕
    
```

Position markers are output from **SYNC OUT** when the source (*src*) is set to *pos'n marker* on the SYNC OUTPUT SETUP screen.

Position markers can be set at any or all of the addresses of a waveform either individually, using the *ads* (address) soft key, or as a pattern, using the *patterns...* menu.

A marker can be set directly at an address by pressing the *ads* soft key followed by a keyboard entry; pressing the right-hand soft key on the *ads* line then toggles the marker setting between *<1>* and *<0>* as shown in the arrowed brackets. The address can be changed by incrementing with the *ads* key, by using the rotary control, or by further keyboard entries; marker settings are changed at each new address with the right-hand soft key. Markers show immediately they are changed.

Alternatively, markers can be input as patterns by using the *patterns...* sub-menu:

```

PATTERN: 00000000...↕
↕start: 0000000
↕stop: 0001023
↕exit:  do pattern↕
    
```

The start and stop addresses of the markers within the waveform are set using the *start* and *stop* soft keys respectively, followed by an entry on the keyboard or by using the rotary control.

The pattern itself is set in the top line of the display; press the soft key to the right of *PATTERN:* and enter the sequence of 1s and 0s using **1** and **0** from the keyboard (which auto-increments to the next character) or with the rotary control (using the cursor keys to move the edit cursor along the pattern). The pattern consists of 16 values; if the cursor keys are used to skip over some character positions these will automatically be filled with the value of the last digit specified to the left. The pattern is entered repeatedly across the whole range defined by the *start* and *stop* addresses when the *do pattern* soft key is pressed; pressing *exit* returns to the POSITION MARKER EDIT screen without implementing the pattern.

Pressing the *clear all* soft key displays a request for confirmation that all markers should be cleared from the waveform. Pressing *clear* cancels all the markers and returns the display to POSITION MARKER EDIT ; pressing *cancel* aborts the clear.

Arbitrary Waveform Sequence

Up to 1024 arbitrary waveforms may be linked in a sequence provided that the total number of points of all the waveforms in the sequence does not exceed 1,048,576. Each waveform can have a loop count of up to 32,768 and the whole sequence can run continuously or be looped up to 1,048,575 times using the triggered burst mode.

Pressing the **SEQUENCE** key calls the initial `SEQUENCE` screen:

```

SEQUENCE segs=    1
◇sequence setup...
◆stop                run◇

```

A previously-defined sequence can be run and stopped from this screen using the `run` and `stop` soft keys; sequence can also be switched on from the `STANDARD WAVEFORMS` screen with the `sequence` soft key. The `segs=` field shows the number of segments in the sequence; there is always at least 1 segment.

Sequence Set-Up

Pressing the `sequence setup...` soft key on the `SEQUENCE` screen (or the `setup...` soft key next to sequence on the `STANDARD WAVEFORMS` screen) calls the sequence set up screen:

```

◆seg: 0002        off◇
◆wfm WFM3
◇step on: count
◇cnt: 00001      done◇

```

Repeated presses of the `seg` soft key steps the display through the set-ups of each of the 1024 segments of the sequence. With the exception of segment 1 which is always on (and therefore has no on-off soft key) the segment set-ups are identical in format. When segment 1 is displayed the `segs=` field shows the total number of segments in the current sequence.

The segment to be set up is selected with the `seg` soft key; the segments can be selected in sequence with repeated presses of the soft key, by using the rotary control or by numeric entry.

Once the segment to be edited has been set the waveform for that segment is selected with the `wfm` (waveform) soft key; the list of all arbitrary waveforms already created is stepped through with repeated presses of the `wfm` soft key or by using the rotary control.

The criterion for stepping between waveform segments is set by the `step on` soft key. The default setting is `step on: count` which means that the waveform will step on to the next segment after the number of waveform cycles specified in the `cnt` (count) field; up to 32,768 cycles can be set with `cnt` selected, using direct keyboard entries or using the rotary control.

Alternatively, the step on criteria can be set to `trig edge` or `trig level` in the `step on` field; trigger edge or trigger level can be mixed with count (i.e. some segments can step on count, others on the specified trigger condition) but trigger edge cannot be mixed with trigger level in the same sequence.

If `trig edge` is selected the sequence starts running at the first waveform segment when sequence is set to `run` and steps to the following segments in turn at each subsequent trigger. The trigger source can be any of the settings selected on the `TRIGGER IN` set-up screen (called by the **TRIG IN** key); these are described fully in

chapter 7, *Triggered Burst and Gate*. At each trigger the current waveform cycle plus one further whole cycle are completed before the waveform of the next segment is started.

If `trig level` is selected the sequence runs continuously through each segment in turn (one cycle per segment) while the trigger level is true. When the trigger level goes false the waveform currently selected runs continuously until the level goes true again, at which point the sequence runs continuously through each segment in turn again. The trigger level source can be any of the settings selected on the `TRIGGER IN` set-up screen with the exception of the **MAN TRIG** key which can only produce an edge, not a level, when pressed.

Providing the `step on:` field is set to `count` for all segments the waveform sequence can also be run in gated and triggered burst modes in the same way as simple waveforms; refer to chapter 7, *Triggered Burst and Gate*, for full details.

The individual segments of the sequence can be turned on or off with the `on-off` soft key. Note that turning a segment off will automatically set all subsequent segments off; turning a segment on will also turn on any others between segment 1 and itself that were previously off. Segment 1 is always on.

When the whole sequence is defined the set-up is constructed by pressing the `done` soft key which returns the display to the initial `SEQUENCE` screen. The sequence can be run and stopped from this screen with the `run` and `stop` soft keys respectively.

Frequency and Amplitude Control with Arbitrary Waveforms

Frequency and amplitude control work in an essentially similar manner as with standard waveforms; the differences are as follows:

Frequency

Pressing the `FREQUENCY` key with an arbitrary waveform selected calls the `ARBITRARY FREQUENCY` screen:

```

◇ARB FREQUENCY: int
  100.00000 MHz
◆sample      waveform◇
◆freq        period◇
```

Arbitrary mode uses clock synthesis generation (see *Principles of Operation* in chapter 4, *Initial Operation*) which has a setting resolution of only 8 digits. However, the clock can also be provided from an external source via the rear panel **ARB CLOCK IN/OUT** socket or, on multi-channel instruments, the system clock. The clock source switches between internal and external clock with alternate presses of the `ARB FREQUENCY` soft key. When external clock is selected the `ARB FREQUENCY` screen changes to:

```

◇ARB FREQUENCY: ext
  source: ext arb clk
```

on a single channel instrument, or

```
◇ARB FREQUENCY: ext
      source: ext arb clk
◇freq: 10.000000kHz
```

on a multi-channel instrument. It is then possible to select the source to be either an external signal on the **ARB CLOCK IN/OUT** socket or the internal system clock; see the *Reference Clock IN/OUT* and *System Clock Setting* sections of Chapter 15, *System Operations from the Utility Menu* for the use of and frequency setting for the system clock.

Note that `SEQUENCE` and the 'standard' waveforms of square, pulse and pulse-train also operate in clock synthesis mode and consequently can also be set to external clock on the appropriate `FREQUENCY` menus; refer to the relevant sections for further details.

Having selected external clock the arbitrary waveform will continue to run from the internal clock until the instrument receives the first rising edge of the external clock; at that point the hardware switches over to the external source.

The following applies only to internal clock selection.

Frequency can be set in terms of frequency or period, as for standard waveforms, by pressing the `freq` or `period` soft key respectively. Additionally, for arbitrary waveforms, frequency or period can be set in terms of the sample clock frequency, by pressing the `sample` soft key, or in terms of the waveform frequency, by pressing the `waveform` soft key. The relationship between them is:

$$\text{waveform frequency} = \text{sample frequency} \div \text{waveform size.}$$

Frequency and period entries are made directly from the keyboard or by using the rotary control in the usual way. Pressing the `FREQUENCY` key with sequence running calls the `SEQ FREQUENCY` screen:

```
◇SEQ FREQUENCY: int
      100.00      MHz
◆freq           period◇
```

With internal clock selected (the default), frequency or period can now **only** be set in terms of the clock frequency. Frequency or period entries are made directly from the keyboard or by using the rotary control in the usual way.

With external clock selected using the `SEQ FREQUENCY` soft key the sequence can be clocked using an external source connected to the rear panel **ARB CLOCK IN/OUT** socket.

Amplitude

Pressing the **AMPLitude** key with an arbitrary waveform selected calls the **AMPLITUDE** screen.

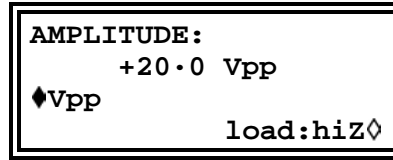

This differs from the **AMPLITUDE** screen for standard waveforms in that amplitude can now only be entered in volts peak-to-peak.

Note that the peak-to-peak amplitude set will only actually be output if the arbitrary waveform has addresses with values which reach -2048 and +2047; if the maximum value range is -1024 to +1023 for example then the maximum peak-to-peak voltage will only be 10 V p-p for the instrument set to 20 V p-p.

Sync Out Settings with Arbitrary Waveforms

The default setting for sync out when arbitrary waveforms are selected is **waveform sync**; this is a pulse that starts coincident with the first point of the waveform and is a few points wide.

If a waveform sequence has been selected then sync out defaults to **sequence sync**; this is a waveform which goes low during the last cycle of the last waveform in a sequence and is high at all other times. When sequence is used in triggered burst mode the burst count is a count of the number of complete sequences.

Waveform Hold in Arbitrary Mode

Arbitrary waveforms can be paused and restarted by using the front panel **MAN HOLD** key or by a signal applied to the rear panel **HOLD IN** socket.

On multi-channel instruments the channels which are to be held by the **MAN HOLD** key or **HOLD IN** socket must first be enabled using the **ARB HOLD INPUT** screen, accessed by pressing the **HOLD** key:

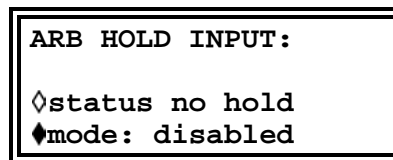

Each channel is selected in turn using the channel set-up keys and set using the **mode** soft-key; the mode changes between **disabled** and **enabled** with alternate key presses.

Pressing the front panel **MAN HOLD** key stops the waveform at the current level on all enabled channels; pressing **MAN HOLD** a second time restarts the waveform from that level. If the **ARB HOLD INPUT** screen is currently selected the **status** field will change from **no hold** to **manual hold** while the waveform is paused.

Output Filter Setting

The output filter type is automatically chosen by the software to give the best signal quality for the selected waveform. The choice can, however, be overridden by the user and this is most probably a requirement with arbitrary waveforms.

To change the filter, press the **FILTER** key to call the `FILTER SETUP` screen:

```
FILTER SETUP
mode: auto
type: 40MHz elliptic
```

The default mode is `auto` which means that the software selects the most appropriate filter. With the setting on `auto` the type can be changed manually but the choice will revert to the automatic selection as soon as any relevant parameter is changed. To override the automatic choice press the `mode` soft key to select `manual`.

The three filter choices, which are either automatically selected or set manually with the `type` soft key, are as follows:

- 40MHz elliptic: The automatic choice for sine, cosine, haversine, havercosine, $\sin(x)/x$ and triangle. Would be the better choice for arb waveforms with an essentially sinusoidal content.
- 20MHz Bessel: The automatic choice for positive and negative ramps, arb and sequence.
- No filter: The automatic choice for square wave, pulses and pulse-trains. May be the better choice for arb waveforms with an essentially rectangular content.

Chapter 10

Pulse and Pulse-trains

Title	Page
Introduction.....	10-2
Pulse Set-Up	10-2
Pulse-Train Set-Up	10-4
Waveform Hold in Pulse and Pulse-Train Modes	10-8

Introduction

Pulse and pulse-trains are both selected and set-up from independent menus on the STANDARD WAVEFORMS screen called by pressing the **STD** key. Pulse and pulse-trains have similar timing set-ups and considerations but pulses are only unipolar, with a maximum amplitude of 10 V p-p, whereas pulse-trains can be bipolar, with a maximum peak-to-peak of 20 V p-p.

Pulse Set-Up

Pulse waveforms are turned on with the `pulse` soft key on the STANDARD WAVEFORMS screen; pressing the `setup...` soft key beside `pulse` calls the first of the pulse set-up screens:

```

Enter pulse period:
100.00000 us
10000pts*10.000000ns
◇exit                next◇
  
```

The third line of the screen indicates how the waveform will be constructed; in this case it will be 10000 points played back at a clock period of 10.000000ns to give a period of $10000 \times 10^{-9} = 100\mu\text{s}$. These values will change as the period is varied. The clock period will determine the resolution available for setting the delay and width as discussed below.

The pulse period can be set between 40.000000 ns and 100.00000 s, with 4-digit resolution, by direct entries from the keyboard or by using the rotary control. Pressing the `next` soft key calls the pulse width screen:

```

Enter pulse width:
program 50.000000 us
actual  50.000000 us
◇exit                next◇
  
```

The width can be entered directly from the keyboard or by using the rotary control. Any value in the range 10.00000 ns to 99.999999 s can be programmed but the actual value may differ because of the considerations discussed below; for this reason the actual pulse width is shown below the program width.

Pressing the `next` soft key calls the pulse delay screen:

```

Enter pulse delay:
program+0.0000000 ns
actual +0.0000000 ns
◇exit                done◇
  
```

This is very similar to the pulse width screen and, again, the `actual` delay is shown below the program delay. The delay value that can be entered must be in the range \pm (pulse period -1 point); positive values delay the pulse output with respect to waveform sync from **SYNC OUT**; negative values cause the pulse to be output before the

waveform sync. Pressing the `done` soft key on this screen returns the display to the STANDARD WAVEFORMS screen.

The means by which pulse period is set-up in the hardware requires an understanding because it affects the setting resolution of both pulse width and delay. Pulse is actually a particular form of arbitrary waveform made up of between 4 and 100,000 points; each point has a minimum duration of 10-000000 ns corresponding to the fastest clock frequency of 100 MHz.

At short pulse periods, i.e. only a few points in the waveform, the period setting resolution is, however, much better than 10-000000 ns because the time-per-point is adjusted as well as the number of points; since the pulse width and delay are also defined in terms of the same point time, varying the time-per-point affects their resolution. For example, if the period is set to 200.00000 ns, the minimum pulse width, when set to 10-000000 ns, will actually be 10-000000 ns; 20 points at 10-000000 ns each exactly define the 200.00000 ns period. However, if the period is set to 199-00000 ns, 20 points at the minimum point time of 10-000000 ns will be too long so 19 points are used and the point time is adjusted to 10.473684 ns (199-0÷19); 10.473654 ns is now the increment size used when changing the pulse width and delay.

For periods above 1 ms the maximum number of points in the waveform (100,000) becomes the factor determining pulse width and delay resolution. For example, with the period set to 100 ms, the smallest pulse width and delay increment is 1 µs (100 ms÷100,000). This may appear to cause significant errors at extreme settings (e.g. setting 10 ns in the above example will still give an actual width of 1 µs) but in practical terms a 1 in 100,000 resolution (0-001 %) is quite acceptable.

Pulse period can be adjusted irrespective of the pulse width and delay setting (for example, it can be set smaller than the programmed pulse width) because, unlike a conventional pulse generator, pulse width and delay are adjusted proportionally as the period is changed. For example, if, from the default pulse settings of 100 µs period and 50 µs width, the period is changed to 60 µs the pulse width actual changes to 30 µs even though the program width is still 50 µs; to get a 50 µs width with the period at 60 µs the width must be re-entered as 50 µs after the period has been changed.

Period can also be changed from the PULSE PERIOD screen called by pressing the **FREQ** key with pulse mode selected.

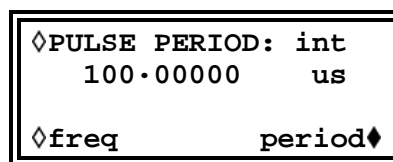

The new setting can be entered either as a period in the way already described or as a frequency by first pressing the `freq` soft key. However, changing the period or frequency from this screen is slightly different from changing period on the pulse set-up screen. When changing from this screen the number of points in the waveform is never changed (just as with a true arb) which means that the shortest period (highest repetition frequency) that can be set is the number of waveform points multiplied by 10-00 ns. To achieve faster frequencies (up to the specification limit) the period must be changed from the pulse set-up screen; changing the frequency from the pulse set-up screen causes the number of points to be reduced as the period is reduced (for periods <1ms).

Because pulse waveforms are actually a particular form of arb and use clock synthesis mode, pulse mode can also be operated with an external clock connected to the rear panel

ARB CLOCK IN/OUT socket, or to the system clock on multi-channel instruments. To select external clock mode press the **PULSE PERIOD** soft key on the **PULSE PERIOD** screen (or the **PULSE FREQ** soft key on the **PULSE FREQ** screen) to change from internal to external clock. The screen changes to, for example:

```
◇PULSE PERIOD: ext
source: ext arb clk
```

on a single-channel instrument, or

```
◇PULSE PERIOD: ext
◆source: ext arb clk
◇freq: 10.000000kHz
```

on a multi-channel instrument. It is then possible to select the source to be either an external signal on the **ARB CLOCK IN/OUT** socket or the internal system clock; see the *Reference Clock IN/OUT* and *System Clock Setting* sections of Chapter 15, *System Operations from the Utility Menu* for the use of and frequency setting for the system clock.

Note that the pulse waveform will continue to run from the internal clock until the instrument receives the first rising edge of the external clock; at that point the hardware switches over to the external source. In external clock mode the period of the pulse waveform is determined by the number of points in the waveform multiplied by the period of the external clock. The external clock period is determined by the user; the number of points in the pulse waveform can be found, **before selecting external clock**, by pressing the set-up soft key beside pulse on the **STANDARD WAVEFORMS** screen.

Pulse-Train Set-Up

Pulse-trains are turned on with the pulse-train soft key on the **STANDARD WAVEFORMS** screen; pressing the **setup...** soft key beside pulse-train calls the first of the set-up screens:

```
Enter no of pulses
in train (1-10):
      2
◇done      next◇
```

The number of screens used for the set-up depends on the number of pulses in the pulse-train. The first three screens define the parameters that apply to the whole pattern (number of pulses, overall pulse-train period and baseline voltage); subsequent screens define the pulse level, width and delay for each pulse in turn (three screens for pulse 1, then three screens for pulse 2, etc.).

Pressing `next` on any screen calls the next set-up screen, finally returning the display to the `STANDARD WAVEFORMS` screen from which pulse-train can be turned on and off. Pressing `done` returns the display directly to the `STANDARD WAVEFORMS` screen from any set up screen. The pulse-train is built only after `next` is pressed after the last parameter set-up or whenever `done` is pressed, assuming a change has been made. The first screen, shown above, sets the number of pulses (1 to 10) in the pattern; enter the number of pulses directly from the keyboard or by using the rotary control.

Pressing `next` calls the pulse train period screen:

```

pulse train period:
  100.00000us
10000pt*10.000000ns
◇done                next◇
    
```

The third line of the screen indicates how the waveform will be constructed; in this case it will be 10000 points played back at a clock period of 10.000000ns to give a period of $10000 \times 10^{-9} = 100\mu\text{s}$. These values will change as the period is varied. The clock period will determine the resolution available for setting the delay and width as discussed below.

The period can be set, with 8 digit resolution, from 10·000000 ns to 100 s by direct keyboard entries or by using the rotary control.

Pressing `next` calls the baseline voltage screen, the last of the general set-up screens:

```

Enter the baseline
voltage:
  +0.000 V
◇done                next◇
    
```

The baseline is the signal level between the end of one pulse and the start of the next, i.e. it is the level at which all pulses start and finish. The baseline can be set between -5·0V and +5·0V by direct keyboard entries or by using the rotary control. Note that the actual baseline level at the output will only be as set in this field if the output amplitude is set to maximum (10 V p-p into 50 Ω) on the `AMPLITUDE` screen and terminated in 50 Ω. If the amplitude were set, for example, to 5 V p-p into 50 Ω then the actual baseline range would be -2·5 to +2·5 V for set values of -5·0 to +5·0 V, i.e. the amplitude control scales the baseline setting. The actual output levels are doubled when the output is not terminated.

Pressing `next` on this screen calls the first of the three screens which define the first pulse in the train:

```

◇Pulse 1 level
◇                +5.000 V
◇done                next◇
    
```

The pulse level can be set on this screen between -5.0 V and +5.0 V by direct keyboard entries or by using the rotary control. As with the baseline level described above the set pulse levels are only output if the amplitude setting is set to maximum (10 V p-p into 50 Ω) on the `AMPLITUDE` screen and terminated in 50 Ω . Adjusting the amplitude scales both the peak pulse levels and baseline together, thus keeping the pulse shape in proportion as the amplitude is changed, exactly as for arb waveforms. Output levels are doubled when the output is not terminated.

Note that by pressing the `Pulse` soft key on this (and subsequent screens) the pulse to be edited can be directly set from the keyboard or by using the rotary control; this is useful in directly accessing a particular pulse in a long pulse train instead of having to step through the whole sequence.

Pressing `next` calls the pulse width screen for the first pulse:

```

◇Pulse 1 width
●program 25.000000us
  actual 25.000000us
◇done           next◇

```

The width can be entered directly from the keyboard or by using the rotary control. Any value in the range 10.000000 ns to 99.999999 s can be programmed but the actual value may differ; for this reason the `actual` pulse width is shown below the `program` width. The variation between `program` and `actual` will only really be noticeable for very short pulse-train periods (only a few points in the pulse-train) and very long periods (each of the 50,000 points has a long dwell time) for exactly the same reasons as described in the *Pulse Set-up* section above, where there is a detailed explanation.

Pressing `next` calls the pulse delay screen for the first pulse:

```

◇Pulse 1 delay
●program+0.000000ns
  actual +0.000000ns
◇done           next◇

```

The pulse delay is entered in the same way as pulse width and, again, the `actual` delay is shown below the `program` delay for the same reasons. The delay value that can be entered must be in the range \pm (pulse-train period -1 point); positive values delay the pulse with respect to waveform sync from **SYNC OUT**; negative values cause the pulse to be output before the waveform sync.

Pressing `next` on this screen calls the first of the 3 screens for setting the parameters of pulse 2, and so on through all the pulses in the pulse-train. In this way all parameters of all pulses are set. The pulse-train is built when `next` is pressed on the last screen of the last pulse or when `done` is pressed on any screen.

Care must be taken that the set widths and delays of the individual pulses are compatible with each other and the overall pulse-train period, i.e. delays must not be such that pulses overlap each other and delays + widths must not exceed the pulse-train period; unpredictable results will occur if these rules are not followed.

Once the pulse-train has been defined the period can be adjusted irrespective of the pulse width and delay settings for the individual pulses because, unlike a conventional pulse

generator, the individual pulse widths and delays are adjusted proportionally to the period as the period is changed.

Period can also be changed from the PULS-TRN PERIOD screen called by pressing the **FREQ** key with pulse-train mode selected:

```

◇PULS-TRN PER: int
    100.00000 us
◇freq          period◇
    
```

The new setting can be entered either as a period in the way already described or as a frequency by first pressing the `freq` soft key. However, changing the period or frequency from this screen is slightly different from changing the period on the pulse-train set-up screen. When changing from this screen the number of points in the waveform is never changed (just as with a true arb) which means that the shortest period (highest frequency) that can be set is the number of waveform points times 10.00 ns. To achieve faster frequencies (up to the specification limit) the period must be changed from the pulse-train set-up screen. Changing the frequency from the pulse-train set-up screen causes the number of points to be reduced as the period is reduced (for periods less than 1.00 ms).

Because pulse-train waveforms are actually a particular form of arb and use clock synthesis mode, pulse-train mode can also be operated with an external clock connected to the rear panel **ARB CLOCK IN/OUT** socket or the system clock on multi-channel instruments. To select external clock mode press the PULS-TRN PER soft key on the PULS-TRN PER screen (or the PULSE FREQ soft key on the PULSE FREQ screen) to change from internal to external clock. The screen changes to, for example:

```

◇PULS-TRN PER: ext
    source: ext arb clk
    
```

on a single channel instrument, or

```

◇PULS-TRN PER: ext
◇source: ext arb clk
◇freq: 10.000000kHz
    
```

on a multi-channel instrument. It is then possible to select the source to be either an external signal on the **ARB CLOCK IN/OUT** socket or the internal system clock; see the *Reference Clock IN/OUT* and *System Clock Setting* sections of Chapter 15, *System Operations from the Utility Menu* for the use of and frequency setting for the system clock.

Note that the pulse-train waveform will continue to run from the internal clock until the instrument receives the first rising edge of the external clock; at that point the hardware switches over to the external source. In external clock mode the period of the pulse-train waveform is determined by the number of points in the waveform multiplied by the period of the external clock. The external clock period is determined by the user; the number of points in the pulse-train waveform can be found, **before selecting external clock**, by pressing the `setup` soft key beside `pulse-train` on the `STANDARD WAVEFORMS` screen.

Waveform Hold in Pulse and Pulse-Train Modes

Pulse and pulse-train waveforms can be paused and re-started on any channel by using the front panel **MAN HOLD** key or by applying a signal to the rear panel **HOLD IN** socket.

On multi-channel instruments the channels which are to be held by the **MAN HOLD** key or **HOLD IN** socket must first be enabled using the `ARB HOLD INPUT` screen, accessed by pressing the **HOLD** key:

```
ARB HOLD INPUT:
status: no hold
mode: disabled
```

Each channel is selected in turn using the channel **SETUP** keys and set using the `mode` soft-key. The mode changes between `disabled` and `enabled` with alternate key presses.

Pressing the front panel **MAN HOLD** key stops the waveform at the current level on all enabled channels; pressing **MAN HOLD** a second time restarts the waveform from that level. If the `ARB HOLD INPUT` screen is currently selected the `status` field will change from `no hold` to `manual hold` while the waveform is paused.

A logic low or switch closure at the rear panel **HOLD IN** socket also stops the waveform at the current level on all enabled channels; a logic high or switch opening restarts the waveform from that level. If the `ARB HOLD INPUT` screen is currently selected the `status` field will change from `no hold` to `ext hold` while the waveform is paused.

Chapter 11

Modulation

Title	Page
Introduction.....	11-2
External VCA	11-2
External SCM	11-3
Internal Modulation	11-3

Introduction

Both internal and external modulation can be selected. External modulation can be applied to any or all channels. Internal modulation uses the previous channel as the modulation source, e.g. channel 2 can be used to modulate channel 3; internal modulation is not available on channel 1 or on a single channel instrument.

The external modulation mode can be set to VCA (voltage controlled amplitude) or SCM (suppressed carrier modulation) mode. Internal modulation uses the previous channel as the modulation source; for example channel 2 can be used to modulate channel 3. Thus internal modulation is not available on channel 1 or on a single channel instrument.

Modulation modes share some of the generator's inter-channel resources with Sum modes; as a result there are some restrictions on using Modulation and Sum together but these are generally outside the range of common-sense applications. To better understand these constraints the following sections (and the *Sum* chapter) should be read with reference to the block diagrams in the Appendix, which show the control signals of a single channel and the inter-channel connections.

These diagrams also show the inter-channel trigger connections described in the Triggered Burst and Gate chapter; in general, inter-channel triggering is possible simultaneously with modulation but few combinations are of real use.

Pressing the **MODULATION** key calls the `MODULATION` set-up screen.

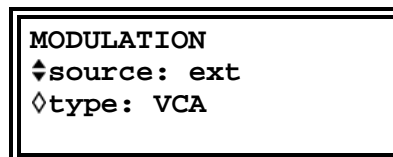

The `source` soft key steps the modulation choice between `off`, `external` and `CHx` where x is the number of the previous channel; note that channel 1 does not have a previous channel.

With `ext` selected the modulation can be switched between `VCA` and `SCM` with alternate presses of the `type` soft key. External modulation can be used with internal or external sum. External modulation can be applied to any or all channels.

External VCA

Select `VCA` with the `type` soft key on the `MODULATION` screen. Connect the modulating signal to the **MODULATION** socket (nominally 1 k Ω input impedance); a positive voltage increases the output amplitude and a negative voltage decreases the amplitude. Note that clipping will occur if the combination of amplitude setting and VCA signal attempts to drive the output above 20 V p-p open circuit voltage.

External AM is achieved by setting the required output level and applying the modulation signal (which can be ac coupled if required) at the appropriate level to obtain the modulation depth required. If the output level is changed the amplitude of the modulating signal will have to be changed to maintain the same modulation depth.

The VCA signal is applied to the amplifier chain prior to the output attenuators. The amplifier itself is controlled over a limited range (approximately 10 dB) and the full amplitude range is achieved by switching in up to five 10 dB attenuation stages. Peak modulation cannot exceed the maximum of the range within which the channel output has been set by choice of amplitude setting. Whereas with internal AM the generator

gives warnings when the combination of modulation depth and amplitude setting cause waveform clipping (see *Internal Modulation* section), it is up to the user to observe the waveforms when using external VCA and to make adjustments if the waveform is clipping. Note that it is not possible to give a simple guide as to where the range breakpoints are because the use of dc offset, for example, changes these points.

Within each range the maximum output setting at which clipping is avoided is reduced from range maximum to half this value as modulation is increased from 0 % to 100 %; 100 % modulation will be achieved at this mid-range setting with an external VCA signal of approximately 1 V p-p.

It is also possible to modulate a dc level from the generator with a signal applied to the **MODULATION** socket, as follows. Set the generator to external trigger on the **TRIGGER IN** set-up screen but do not apply a trigger signal to the **TRIG IN** socket; select square wave. The **MAIN OUT** is now set at the peak positive voltage defined by the amplitude setting; pressing the \pm key with **AMPLITUDE** displayed will set the level to the peak negative voltage. This dc level can now be modulated by the signal applied to the **MODULATION** input.

External SCM

Select SCM with the `type` soft key on the **MODULATION** screen. Connect the modulating signal to the **MODULATION** input (nominally 1 k Ω input impedance). With no signal the carrier is fully suppressed; a positive or negative level change at the modulation input increases the amplitude of the carrier. Note that clipping will occur if the SCM signal attempts to drive the output above the 20 V p-p open circuit voltage.

Peak modulation, i.e. maximum carrier amplitude (20 V p-p), is achieved with an external SCM level of approximately ± 1 V, i.e. a 2 V p-p signal.

When external SCM is selected the amplitude control is disabled; the **AMPLITUDE** set-up screen shows the message `fixed by SCM`.

Internal Modulation

Only the multi-channel instruments (models 292 and 294) can make use of internal modulation; the single-channel model 291 has no internal modulation capability.

Pressing the **MODULATION** key calls the **MODULATION** set-up screen.

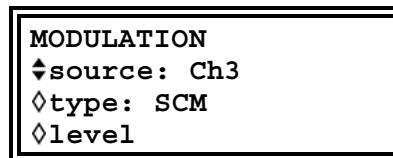

The `source` soft-key steps the modulation choice between `off`, `external` and `CHx` where `x` is the number of the previous channel.

With `CHx` selected the modulation can be switched between `AM` and `SCM` with alternate presses of the `type` soft-key.

When `AM` is selected the screen has an additional soft-key labeled `depth`; selecting this key permits the modulation depth to be set directly from the keyboard or by the rotary control.

Warnings are given when either a modulation depth or output amplitude change has caused clipping; the new setting is accepted but it must either be changed back or the other parameter must also be changed to avoid the contention.

When `SCM` is selected the screen has an additional soft-key labeled `level`; selecting this key permits the peak carrier output level to be set directly from the keyboard or by the rotary control. The maximum output level that can be set is 10 V p-p.

When internal `SCM` is selected for a channel both the amplitude control of that channel and of the previous channel (which is the modulation source) are disabled. The `AMPLITUDE` set-up screen of the channel being modulated shows the message `fixed by SCM`. The `AMPLITUDE` screen of the previous channel shows the message `Set by CHx mod` and its status screen shows the message `•x` to indicate that it is being used as a source for channel x.

Internal modulation cannot be used with internal or external sum.

Chapter 12

Sum

Title	Page
Introduction.....	12-2
External Sum.....	12-2
Internal Sum.....	12-3

Introduction

Both internal and external Sum can be selected; summing can be used to add ‘noise’ to a waveform, for example, or to add two signals for DTMF (Dual Tone Multiple Frequency) testing.

External sum can be applied to any or all channels. Internal sum uses the previous channel as the source, so that for example channel 2 can be added into channel 3; internal sum is not available on channel 1 or on a single channel instrument.

Summing shares some of the generator’s inter-channel resources with the modulation modes; as a result neither internal nor external sum can be used with internal modulation but external modulation is still possible with sum.

To better understand the constraints, the following sections (and chapter 11, *Modulation*) should be read with reference to the block diagrams at the end of the manual. These show the control signals in a single channel and the inter-channel connections.

The diagrams also show the inter-channel trigger connections described in chapter 7, *Triggered Burst and Gate*; in general, inter-channel triggering is possible simultaneously with summing.

External Sum

In sum mode an external signal applied to the **SUM** input is summed with the waveform(s) on the specified channel(s). The same sum input signal can be used at different amplitudes with each of the channels with which it is summed.

Pressing the **SUM** key calls the SUM set-up screen:

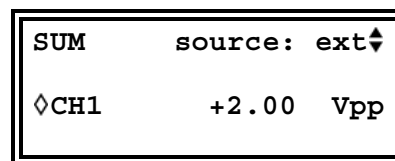

Pressing the `source` soft-key steps the sum source between `off`, `external` and `CHx` (where `x` is the number of the previous channel). With `ext` selected the screen is as shown above.

Clipping will occur if the sum input level attempts to drive the channel amplitude above the maximum 20 V p-p open-circuit voltage. However, the relationship between the **EXT SUM** input and the maximum summed output depends not only on the sum input level but also on the channel's own amplitude setting. This is because the sum input is applied to the amplifier chain prior to the output attenuators. The amplifier itself is controlled over a limited range (approximately 10 dB) and the full amplitude range of the channel is achieved by switching in up to five 10 dB attenuation stages. The summed output cannot exceed the maximum of the range within which the channel output has been set by choice of amplitude setting. Whereas with internal sum the generator gives warnings when the combination of sum input and amplitude would cause waveform clipping (see *Internal Sum* below), it is the responsibility of the user to observe the waveforms when using external sum and to make adjustments if the waveform is clipped. Note that it is not possible to give a simple guide as to where the range breakpoints are because the use of dc offset, for example, changes these points.

Within each range an **EXT SUM** signal of approximately 2 V p-p will force the channel output from the range minimum to the range maximum; if the channel amplitude is set to

mid-range then the **SUM** signal needed to force the output to range maximum is halved to approximately 1 V p-p.

To facilitate the setting of appropriate sum and amplitude levels the output amplitude of the selected channel can also be changed from the `SUM` set-up screen. Press the `CHx` soft-key and adjust the amplitude with direct keyboard entries or by using the rotary control.

External sum cannot be used with internal modulation.

Internal Sum

Pressing the **SUM** key calls the `SUM` set-up screen:

<code>SUM</code>	<code>source: CH1</code>	↕
<code>ratio:</code>	<code>1.00000</code>	
<code>CH2</code>	<code>+2.00</code>	<code>Vpp</code>
<code>CH1</code>	<code>+1.00</code>	<code>Vpp</code>

Pressing the `source` soft-key steps the sum source between `off`, `external` and `CHx` (where `x` is the number of the previous channel). `CHx` is the source of the internal sum signal.

With `CHx` selected for internal sum the screen is as shown above. The amplitude of both the summing channel, `CHx+1`, and the internal sum signal, `CHx`, are shown in the display, together with the `ratio` in which they are added. All three parameters can be selected with the appropriate soft-key and set directly from the keyboard or by the rotary control. Changing any one parameter will also adjust one of the other two; for example adjusting the amplitude of either channel will cause the displayed ratio to change.

The value shown in the `ratio` field is the `CHx` amplitude divided by the `CHx+1` amplitude. Adjusting the ratio value directly changes the amplitude of the sum input signal, `CHx`, not the channel's output amplitude. When a value is entered into the `ratio` field it is initially accepted as entered but may then change slightly to reflect the actual ratio achieved with the nearest sum input amplitude that could be set for the given channel output amplitude.

Warnings are given when either a ratio, sum input or output amplitude change is attempted which would cause the channel's output to be driven into clipping.

In general it is recommended that the amplitude of the sum input is not greater than the channel amplitude, i.e. the ratio is less than or equal to 1; most ratio values can be set, down to very small signal levels. If the sum input is greater than the channel amplitude there will be combinations when the ratio can be set to a little greater than 1. Note that the software will always accept an entry, make the calculation and, if the combination is not possible, return the instrument to its last legitimate setting.

The amplitude of the channel being used for the internal sum signal can still be adjusted on its own `AMPLITUDE` set-up screen; its status screen shows the message `→x` to indicate that it is being used as a source for channel `x`.

Internal sum cannot be used with internal modulation.

Chapter 13

Synchronizing

Title	Page
Introduction.....	13-2
Inter-Channel Synchronization	13-2
Synchronizing Principles.....	13-2
Master-Slave Allocation.....	13-2
Phase-Setting Between Channels	13-4
Other Synchronizing Considerations.....	13-4
Synchronizing two generators.....	13-5
Connections for Synchronization	13-6
Generator Set-Ups	13-6
Synchronizing.....	13-7

Introduction

Two or more channels in one multi-channel generator can be synchronized together and precise phase differences can be set between the channels. Two separate generators can also be synchronized, giving a maximum of 8 channels that can be operated synchronously.

Inter-Channel Synchronization

This section covers the use of a multi-channel instrument to produce two or more synchronous signals, and certain restrictions which apply to some specific waveform and frequency combinations.

Synchronizing Principles

Frequency synchronizing is achieved by using the clock output from a master channel to drive the clock inputs of one or more slave channels. Any one channel can be the master and any or all the others can be slaves; master, slaves and independent channels can be mixed on the same instrument.

When frequency synchronization is switched on, an internal synchronizing signal from the CPU synchronizes the channels at the specified inter-channel phase and re-synchronizes them automatically every time the frequency is changed. The clock and internal synchronization signals are shown in the inter-channel block diagram in the appendix. Channels to be synchronized together must all be operated in continuous mode.

For DDS-generated waveforms (see *Principles of Operation* in chapter 4) it is the 100 MHz signal that is distributed from master to slaves and channels can, in principle, be frequency-synchronized with any frequency combination. However, the number of cycles between the phase-referenced points will be excessively large unless the ratio is a small rational number; for example a 2 kHz signal could be synchronized usefully with 10 kHz, 50 kHz, 100 kHz, etc., but not with 2.001 kHz.

For clock synthesized waveforms it is the PLL clock of the master which is distributed from master to slaves; the clock frequency for master and slaves is therefore always the same. The number of points comprising the waveforms should also be the same to ensure that the waveforms themselves appear locked.

From the foregoing it is clear that only DDS slaves can be synchronized to a DDS master and only clock synthesized slaves can be synchronized to a clock synthesized master. In practice the constraints described are not severe as the most common use of synchronization is to provide outputs of the same waveform at the same frequency, or a harmonic of it, often with controlled phase offsets.

Master-Slave Allocation

Press the front panel **INTER CH**annel key to call up the inter-channel set-up screen.

```

mode:  indep
phase:  +000.0°
(actual: +000.0°
status: off  view

```

The `mode` soft-key can be used to select between `independent`, `master`, `master/freq` and `slave`; the default mode is `independent`. Only one `master` can be set; more than one `master` can be selected but when synchronization is turned on with the `status` soft-key the set-up will be rejected. `Master/freq` selects the master and sets frequency-tracking; for this to be operational the master and slave(s) must be set to the same frequency when synchronization is turned on. In this mode, when the frequency of the master is changed the frequency of the slaves also changes and the slaves are re-synchronized to the master.

`Master/freq` is the default mode when the waveforms are clock synthesized (`arb`, `pulse`, etc); if `master` has been set instead the mode will automatically change to `master/freq` when synchronization is turned on. The frequency of clock synthesized waveform slaves always therefore tracks the master. Finally, `slave` selects those channel(s) which are to be synchronized to the master.

At any time, pressing the `view` soft-key gives a graphical view of the master-slave set-up, for example:

```

  CH➔ 1 2 3 4
  indep - - - Y
  master Y - - -
  slave - Y Y - exit◊
```

Channel synchronization is turned on or off with the `status` soft-key. Any illegal setting combinations will result in an error message when an attempt is made to turn status on. Any of the following conditions will cause an error (see also the *Synchronizing Principles* section for a discussion of the set-up constraints):

1. More than one master channel is enabled.
2. No master channel is enabled.
3. The synchronized channels contain a mixture of DDS and PLL generated waveforms.
4. Frequency tracking is enabled (mode: `master/freq`) but the frequencies are not the same on all channels. If clock synthesized waveforms are synchronized the mode will be forced to frequency tracking.
5. A synchronized channel is not set to continuous mode.
6. An attempt is made to turn on synchronization with a frequency set too high.
7. An attempt is made to set the frequency too high with synchronization on. This error does not set synchronization to off, the system simply inhibits the setting of the incorrect frequency.

In addition to the illegal setting combinations there are further considerations which affect the phase resolution and accuracy between channels; see below.

Phase-Setting Between Channels

The inter-channel set-up screen also has a field for setting up the phase of the slaves with respect to the master:

```

mode: indep
phase: +000.0°
(actual: +000.0°
status: off view

```

Selecting the `phase` soft-key allows the phase to be set by direct keyboard entry or by rotary control. Setting the phase of a slave positive advances the waveform of the slave with respect to the master; setting it negative delays the slave with respect to the master. The phase of each slave channel can be set independently. The phase of the master can also be set, although this is intended primarily for use in phase-synchronization between two generators. If both the master and the slaves are set to $+90^\circ$, say, on the same generator then the waveforms will all be in phase again; if the master is set to $+90^\circ$ and the slaves set to -90° the master and slave waveforms will be 180° out of phase.

DDS-generated waveforms can be synchronized with 0.1° resolution up to their maximum available frequency.

The phase-locking resolution of arbitrary waveforms will be less than 0.1° for waveforms of less than 3600 points. The phase is fixed at 0° for pulses, pulse-trains and sequences.

Below is a summary of the phase control and frequency range for different waveforms.

Waveform	Max waveform frequency	Phase control range, resolution
Sine, cosine, haversine, havercosine	40 MHz	$\pm 360^\circ$, 0.1°
Square	50 MHz	$\pm 360^\circ$, 180°
Triangle	500 kHz	$\pm 360^\circ$, 0.1°
Ramp	500 kHz	$\pm 360^\circ$, 0.1°
Sin(x)/x	500 kHz	$\pm 360^\circ$, 0.1°
Pulse & Pulse Train	40 MHz	$\pm 360^\circ$, $360^\circ \div \text{length}$ or 0.1°
Arbitrary	100 MS/s clock	$\pm 360^\circ$, $360^\circ \div \text{length}$ or 0.1°
Sequence	100 MS/s clock	0° only

Other Synchronizing Considerations

The *Master-Slave Allocation* and *Phase-Setting* sections contain tables of specific limitations on the selection of frequency, waveform type and phase-setting range and resolution. The following further points should also be considered.

- The waveform filters introduce a frequency-dependent delay above about 1 MHz; this will affect the accuracy of the phase between synchronized waveforms at different frequencies, e.g. 500 kHz and 5 MHz.
- Square waves, which are 2-point clock synthesized waveforms will not reliably synchronize to other clock synthesized waveforms.

- Pulse and pulse train waveforms will synchronize to other pulse and pulse-train waveforms (and with each other) but should be built with equal periods.
- Arb waveforms should be the same length (although this is not forced and does not create an error message).

When synchronization is turned on with the status soft-key the slaves are re-synchronized automatically after every phase or frequency setting change. This re-synchronization may, depending on the type of waveforms used, cause an interruption of the waveforms as the phases are established. The following show the different possibilities when a frequency is changed.

DDS waveforms with master mode set

There will always be an interruption but this is the only condition which allows the frequencies of the waveform to be different.

DDS waveforms with master/freq mode set.

The frequencies of the waveforms will be the same and there will be no interruption.

Clock synthesized waveforms

Master/freq mode will be set automatically and there will always be an interruption when the frequency is changed.

Clock synthesized waveforms with external arb clock selected

This is the recommended method for synchronizing arbs and pulses. The channels must have external arb clock selected before they are synchronized. The ext arb clock may be provided by an external signal at the **ARB CLOCK IN/OUT** socket or by the system clock.

Synchronizing two generators

Two generators can be synchronized together following the procedure outlined below. It is possible to link more than two generators in this way but results are not guaranteed.

Frequency synchronization is achieved by using the clock output from the master generator to drive the clock input of a slave. The additional connection of an initializing **SYNC** signal permits the slave to be synchronized such that the phase relationship between master and slave outputs is that specified on the slave generator's inter-channel set-up screen.

Synchronization is only possible between generators when the ratio of the master and slave frequencies is rational, e.g. 3 kHz can be synchronized with 2 kHz but not with 7 kHz. Special considerations arise with waveforms generated by clock synthesis mode (square wave, arbitrary, pulse, pulse train and sequence) because of the relatively poor precision with which the frequency is actually derived in the hardware. With these waveforms, frequencies with an apparently rational relationship, say, for example 3:1, may be individually synthesized such that the ratio is not close enough to 3:1 to maintain synchronization over a period of time; the only ratios guaranteed to be realized precisely are integer powers of 2 because the division stages in clock synthesis mode are binary.

A further complication arises with arb waveforms because waveform frequency depends on both waveform size and clock frequency (waveform frequency = clock frequency divided by waveform size). The important relationship with arbs is the ratio of **clock** frequencies and the above considerations on precision apply to them. The most practical use of synchronization will be to provide outputs at the same frequency, or maybe harmonics, but with phase differences.

Connections for Synchronization

The clock connection arrangement is for the rear panel **REF CLOCK IN/OUT** of the master (which will be set to `master`) to be connected directly to the **REF CLOCK IN/OUT** socket of the slave (which will be set to `slave`).

Similarly the synchronizing connection is from any **SYNC OUT** of the master, which all default to `phase lock`, to the **TRIG IN** input of the slave.

Generator Set-Ups

Each generator can have its main parameters set to any value, with the exception that the ratio of frequencies between master and slave must be rational and each generator can be set to any waveform, subject to the limitations described above. Best results will be achieved if the constraints forced on inter-channel synchronization, described in the previous chapter, are adopted for inter-generator synchronization.

The master has its **REF CLOCK IN/OUT** set to `master` on the **REF/SYS CLOCK** menu called by the `sys/ref` soft-key on the **UTILITY** screen. (Refer to chapter 15, *System Operations from the Utility Menu*.)

```
REF/SYS CLOCK:
↑sys clk: off
◇freq: 10.000000kHz
◇ref clk master
```

Repeated presses of the `ref clk` soft-key toggle between the possibilities

The slave is set to `slave`. Setting the master generator to `master` forces the mode to continuous and defaults the **SYNC OUT** output to `phase lock`. Only one of the **SYNC OUT**s is needed for inter-generator synchronization; the others may be reset to other functions if required. The phase relationship between the slave and the master is set on the inter-channel set-up screen of the slave, accessed by pressing the **INTER CH**annel key.

```
↑mode: indep
◇phase: +000.0°
  (actual: +000.0°
◇status: off view◇
```

The phase of the **slave** generator is set by adjusting the phase of the **master channel** on the slave generator's inter-channel set-up screen exactly as described under *Phase-Setting Between Channels* above. The phase(s) of slave channel(s) on the slave generator are set up with respect to the master in the way described in that same section.

When a single-channel generator (which has no inter-channel set-up key or screen) is the slave, its phase is set using the **TRIGGER/GATE SETUP** screen. The *Trigger Phase* section of chapter 7, *Triggered Burst and Gate* covers this process.

The convention adopted for the phase relationship between generators is that a positive phase setting advances the slave generator with respect to the master and a negative setting delays the slave generator. The status of the slave generator on the inter-channel set-up screen must be set to `on` (this is automatic on the single channel instrument).

Hardware delays become increasingly significant as frequency increases, causing additional phase delay between the master and slave. However, these delays can be largely nulled out by 'backing off' the phase settings of the slave.

Typically these hardware delays are as follows:

DDS waveforms: <± 25 ns <1 ° to 100 kHz

Clock synthesized waveforms: <300 ns <1 ° to 10 kHz.

Clearly a multi-channel generator gives much closer inter-channel synchronization and is the recommended method for up to 4 channels.

Synchronizing

Having made the connections and set up the generators as described in the preceding paragraphs, synchronization is achieved by pressing the **MAN TRIG** key of the slave. Once synchronized any change to the set-up will require resynchronization with the **MAN TRIG** key again.

It is also possible to use an external arb clock when synchronizing two generators. The generators are set up as described for internal clock but all channels are set to external clock. The same external clock should be applied to both generators.

Chapter 14

Memory Card

Title	Page
Introduction.....	14-2
Card Sizes and Formats	14-2
Formatting.....	14-3
Saving Files to a Memory Card	14-3
Avoiding Long Filenames	14-3
Storing and Recalling Set-Ups.....	14-3
Sorting Files.....	14-5

Introduction

Pressing the **UTILITY** key calls a list of menus which give access to various system operations including storing/recalling set-ups from a memory card, error messages, power on settings and calibration.

The instrument uses compact flash memory cards, i.e. cards that comply with the Compact Flash Association standard. A compatible memory card and a USB card reader/writer are supplied with the instrument. The card reader/writer may be connected to a PC to allow waveform files created on the PC to be written directly to a memory card. The memory card may then be transferred to the instrument and the waveform played back immediately. Similarly waveforms created or modified on the instrument may be transferred to the PC.

To install the card reader/writer follow the instructions supplied with it. For Windows ME, 2000, XP and later simply plug the device in to a spare USB port and Windows should detect it; for Windows 98 and 98SE the manufacturer's supplied driver must be installed from the CD-ROM.

Plug the memory card into the memory card slot. On single-channel instruments this is on the rear panel; 2- and 4-channel versions have the card slot on the front panel. Ensure that the pointer on the card aligns with the pointer on the card slot. Push the card gently until it is fully engaged in the connector. The card may be inserted with the power on or off.

When a card is inserted in a powered instrument the message

Opening memory card

will appear on the bottom line of the screen, the **MEMORY CARD ACTIVE** lamp will light and a short beep will sound. The card is then ready for use as described later in this chapter.

To remove the memory card, ensure that the **MEMORY CARD ACTIVE** lamp is off and pull the card straight out of the card slot.



Caution

To avoid the risk of malfunction, card data corruption or firmware lock-up, never remove the memory card when the MEMORY CARD ACTIVE lamp is lit.

Card Sizes and Formats

The instrument is compatible with cards ranging in capacity from 32 MB to 1 GB. From new these cards are formatted with the FAT16 file system. Cards with lower capacity will be formatted with the FAT12 file system which is not readable by the instrument. However, it is possible to reformat these smaller cards with the FAT16 file system in the instrument, from the MEMORY CARD screen, accessed by pressing the memory card... soft-key on the UTILITY MENU.

Take care when formatting memory cards in a PC as cards with capacities less than 32 MB will by default be formatted as FAT12. Furthermore, Windows XP formats larger capacity cards FAT32 which is not readable by the instrument. It is also usual to lose a small amount of capacity when formatting using a PC; this is because the PC treats the card as a removable hard disk and leaves the first 'cylinder' blank. Any card formatted FAT16 by the instrument should work in a PC.

When a new or newly formatted card is inserted in the instrument for the first time it will be prepared for use by adding two directories to the root. These are \WAVES.ARB,

where waveforms are stored, and \SETUP.ARB, where instrument set-ups are stored. The instrument will use these directories exclusively for its files. Each directory may hold up to 510 files, disk capacity permitting. If more than 510 files are stored in these directories some will be invisible to the instrument because its directory cache buffers are a finite size.

Formatting

Pressing the `memory card...` soft-key calls the MEMORY CARD screen:

```
MEMORY CARD 61.0MB
label: TESTARB3
free: 59.6MB
◇format...  sort dir...◇
```

The screen displays the memory card size, its name and the unused capacity. If either the WAVES or SETUP directories are full the screen will show `free: 0.0MB`.

The instrument requires cards formatted with the FAT16 file system (see above). This is the standard format for new card with capacities from 32 MB to 1 GB but previously used cards may have been reformatted elsewhere.

To reformat as FAT16 press the `format...` soft-key followed by `ok` on the subsequent screen. The instrument will warn that re-formatting will cause any data on the card to be lost.

Saving Files to a Memory Card

When creating files the instrument uses the 8.3 file naming format where the 8 is the 8 character filename and 3 is the file extension. The user chooses the filename and the instrument adds the extension. The instrument does not create Windows long filenames. If long filenames exist on the memory card they are ignored by the instrument and the 8.3 alias name is used instead and will appear on the LCD screen.

Avoiding Long Filenames

If long filenames are allowed to get into the directories that the instrument uses they consume directory space and will reduce the maximum number of files that can be seen by the instrument. Unfortunately it is very easy to inadvertently create long filename entries when using the card reader/writer; simply saving a waveform as `wave.wfm` will create a long filename entry and an alias. This is because Windows takes the filename literally as it is entered and, as 8.3 filenames do not allow lower case, any lower case letter in a filename will produce a long filename. To avoid the problem in the above example it is necessary to save the file as `WAVE.WFM`.

The *Waveform Manager* application supplied will ensure that all filenames are short provided that the *download to memory* card function is used to transfer waveforms to the card reader/writer.

Storing and Recalling Set-Ups

Complete set-ups can be stored to or recalled from the memory card using the screens called by the **STORE** and **RECALL** keys. On the single-channel instrument the store function is only available by means of the `store...` soft key on the **UTILITY** menu.

Pressing **STORE** (or `store...`) calls the screen:

```

Save to store:
      "SETUP22 "
execute
  
```

A unique store name must be entered using the left and right cursor keys and the rotary control. The left and right keys step the edit cursor through the eight possible character positions of the name and the rotary control is used to scroll through all possible character choices.

Once the unique name has been entered, the current instrument set-up is saved to that store name by pressing the `execute` soft-key.

If the name already exists, the display changes to give the option to overwrite (`ok`) or `cancel`:

```

File SETUP22
exists,
overwrite?
ok          cancel
  
```

Up to 510 named stores can be accommodated on a memory card subject only to waveform length and card capacity.

Pressing **RECALL** calls the `RECALL` screen:

```

RECALL:      execute
TESTWAVE     delete
SETUP6
SETUP22     default
  
```

The complete list of the set-ups stored on the memory card can be scrolled through the display using the rotary control. To make it easier to find a particular set-up in a long list it is recommended that the set-ups on the card are first sorted into alphabetical order using the sort facility on the `MEMORY CARD` screen, described later in this section.

The required set-up is selected with its corresponding soft-key and the recall is actioned with the `execute` soft-key. The factory defaults (see appendix D) can be recalled using the `default` soft key. Note that loading the defaults does not change any arbitrary waveforms or set-ups stored on the memory card or the RS232/GPIB/USB interface settings. The selected set-up can also be deleted from the memory card using the `delete` soft-key.

Sorting Files

To make it easier to find a particular set-up in a long list it is recommended that the set-ups on the card are first sorted into alphabetical order using the `sort dir...` soft key on the MEMORY CARD screen:

```
DIRECTORY SORT
◇sort waveforms
◇sort setups
◇cancel
```

Press the appropriate soft-key to sort the directory; pressing either `sort`, or `cancel` returns the display to the MEMORY CARD screen.

Chapter 15

System Operations from the Utility Menu

Title	Page
Introduction.....	15-2
Channel Waveform Information.....	15-2
Warnings and Error Messages	15-2
Remote Interface Set-Up.....	15-2
SYS/REF Clock In/Out and System Clock Setting	15-2
Power On Setting	15-3
System Information.....	15-3
Calibration	15-4
Copying Channel Set-Ups	15-4

Introduction

Pressing the **UTILITY** key calls a list of menus which give access to various system operations including storing/recalling set-ups from a memory card, error messages, power on settings and calibration.

Each of the following operations is accessed by pressing the appropriate soft key on the **UTILITY MENU**. Press **UTILITY** again at any time to return to the main utility menu.

Channel Waveform Information

Pressing `chan wfm info...` calls the CHANNEL WFM INFO screen:

```

CHANNEL WFM INFO:
waveforms: 3
free mem: 142146
           exit◇
  
```

This screen shows the number of arbitrary waveforms currently resident in the instrument's high speed memory and the number of free points for further waveforms. This is useful when constructing a large sequence of many waveforms as a guide to the spare memory remaining.

Warnings and Error Messages

The default set-up is for all warning and error messages to be displayed and for a beep to sound with each message. This set-up can be changed on the `error...` menu:

```

◇error beep: ON
◇error message: ON
◆warn beep: ON
◇warn message: ON
  
```

Each feature can be turned **ON** or **OFF** with alternate presses of the appropriate soft-key.

The last two error messages can be viewed by pressing the `last error...` soft-key. Each message has a number and the full list appears in the appendix. See also *Warnings and Error Messages* in chapter 5, *Standard Waveforms*.

Remote Interface Set-Up

Pressing `remote...` calls the **REMOTE** set-up screen which permits RS232, GPIB and USB choice and the selection of address and Baud rate. Full details are given in chapter 17, *Remote operation*.

SYS/REF Clock In/Out and System Clock Setting

This screen allows the system clock frequencies to be set and the **ARB CLOCK IN/OUT** socket to be set to input or output. There is no system clock on a single channel instrument.

The **ARB CLOCK IN/OUT** socket is set to input by setting `sys clk` to `off` and to an output by setting it to `on`. When `sys clk` is on (set to `output`) it is also used as the external clock when a channel is set to use an external arb clock.

The system clock `freq` may be set by numeric entry or rotary control.

Note that the system clock frequency also controls the frequency of the aux sine output on the rear panel.

```
REF/SYS CLOCK:
◆sys clk: off
◆freq: 10.000000kHz
◆ref clk: input
```

The function of the rear panel **REF CLOCK IN/OUT** socket is set on the `SYS/REF CLOCK` screen, called by pressing the `ref/sys clock` soft key.

The default setting is for the socket to be set to `input`, i.e. an input for an external 10 MHz reference clock. When set to `input` the system is automatically switched over to the external reference when an adequate signal level (TTL/CMOS threshold) is detected at **REF CLOCK IN/OUT** but will continue to run from the internal clock in the absence of such a signal.

With the clock set to `output` a buffered version of the internal 10 MHz clock is made available at the socket.

With `master` or `slave` selected the socket can be set to be a master or slave when used for synchronizing multiple generators. Chapter 13, *Synchronizing* provides full details.

Power On Setting

Pressing the `power on...` soft key calls the `POWER ON SETTING` screen:

```
POWER ON SETTING
◆default values
◆restore last setup
◆recall SETUP22
```

The setting loaded at power on can be selected with the appropriate soft key to be `default values` (the default setting), `restore last set-up` (i.e. the settings at power down are restored at power up) or any of the settings stored on the memory card. The complete list of set-ups stored on the card can be scrolled through with further presses of the `recall` soft-key, the cursor keys or the rotary control. `default values` restores the factory default settings (see appendix D).

System Information

The `system info...` soft key calls the `SYSTEM INFO` screen which shows the instrument's name and firmware revision. When `system info...` is pressed a checksum is also made of the firmware code and the result displayed; this can be used when a firmware fault is suspected, to check that the code has not become corrupted.

Calibration

Pressing `calibration` calls the calibration routine, as described in chapter 16, *Calibration*.

Copying Channel Set-Ups

An easy way of copying complete channel set-ups (waveform, frequency, amplitude, etc.) is accessed by pressing the **COPY CHannel** key:

```
copy channel: 1
↕to channel: 2
↕execute
```

The first line of the screen shows which channel is currently selected with the channel **SETUP** keys. Pressing the `to channel:` soft-key steps the channel number through all the other channels of the instrument.

Select the channel to be changed and make the copy by pressing the `execute` soft-key.

Chapter 16

Calibration

Title	Page
Introduction.....	16-2
Equipment Required	16-2
Calibration Procedure	16-2
Setting the Password.....	16-2
Password Access to Calibration	16-3
Changing the Password	16-3
Calibration Routine.....	16-3
Remote Calibration	16-6

Introduction

All parameters can be calibrated without opening the instrument case; the generator offers 'closed-box' calibration. All adjustments are made digitally with calibration constants stored in EEPROM. The calibration routine requires only a digital voltmeter (DVM) and a frequency counter and takes no more than a few minutes.

The crystal in the timebase is pre-aged but a further ageing of up to ± 5 ppm can occur in the first year. Since the ageing rate decreases exponentially with time it is an advantage to recalibrate after the first six month's use. Apart from this it is unlikely that any other parameters will need adjustment.

Calibration should be carried out only after the generator has been operating for at least 30 minutes in normal ambient conditions.

Equipment Required

1. 3½ digit DVM with 0.25 % dc accuracy and 0.5 % ac accuracy at 1 kHz.
2. Frequency counter capable of measuring 10.00000 MHz.

The DVM is connected to the **MAIN OUT** of each channel in turn and the counter to any **SYNC OUT**.

Frequency meter accuracy will determine the accuracy of the generator's clock setting and should ideally be ± 1 ppm.

Calibration Procedure

The calibration procedure is accessed by pressing the `calibration...` soft-key on the UTILITY screen.

```

CALIBRATION SELECTED
  Are you sure ?
◇password...  tests...◇
◇exit        continue◇
  
```

The software provides for a 4-digit password in the range 0000 to 9999. The password is used to protect against accidental or unauthorized access to the calibration procedure. If the password is left at the factory default of 0000 no messages are shown and calibration can proceed as described below; only if a non-zero password has been set will the user be prompted to enter the password.

Setting the Password

On opening the calibration screen press the `password...` soft-key to show the password screen:

```

ENTER NEW PASSWORD
  -----
  
```

Enter a 4-digit password from the keyboard; the display will show the message NEW PASSWORD STORED! for two seconds and then revert to the UTILITY menu. If any keys other than the numeric keys 0 to 9 are pressed while entering the password the message ILLEGAL PASSWORD! will be shown.

The password is held in EEPROM and will not be lost when the memory battery back-up is lost. In the event of the password being forgotten, contact the manufacturer for help in resetting the instrument.

Password Access to Calibration

With the password set, pressing calibration... on the UTILITY screen will now show:



When the correct password has been entered from the keyboard the display changes to the opening screen of the calibration routine and calibration can proceed as described below. If an incorrect password is entered the message INCORRECT PASSWORD! is shown for two seconds before the display reverts to the UTILITY menu.

Changing the Password

With the opening screen of the calibration routine displayed after correctly entering the password, the password can be changed by pressing the password... soft-key and following the procedure described above. If the password is set back to the factory default value 0000, password protection is removed.

Calibration Routine

The calibration procedure is entered by pressing continue on the opening calibration screen; pressing exit returns the display to the UTILITY menu.

Pressing tests... calls a menu of basic hardware checks used at production test; these are largely self-explanatory but details can be found in the *Service Manual* if required. At each step the display changes to prompt the user to adjust the rotary control or cursor keys, until the reading on the specified instrument is at the value given. The cursor keys provide coarse adjustment, and the rotary control fine adjustment.

Pressing next increments the procedure to the next step; pressing CE decrements back to the previous step. Alternatively, pressing exit returns the display to the last calibration screen at which the user can choose to either save new values, recall old values or calibrate again.

The first two displays (CAL 00 and CAL 01) specify the connections and adjustment method. The next display (CAL 02) allows the starting channel to be chosen; this allows quick access to any particular channel. To calibrate the complete instrument choose the default setting of CH1. The subsequent displays, CAL 03 to CAL 115, permit all adjustable parameters to be calibrated.

The full procedure (for the 4-channel instrument) is as follows:

CAL 03	CH1 DC offset zero.	Adjust for 0 V \pm 5 mV
CAL 04	CH1 DC offset at + full scale.	Adjust for +10 V \pm 10 mV
CAL 05	CH1 DC offset at – full scale.	Check for –10 V \pm 3 %
CAL 06	CH1 Multiplier zero.	Adjust for minimum volts ac
CAL 07	CH1 Multiplier offset.	Adjust for 0 V \pm 5 mV
CAL 08	CH1 Waveform offset.	Adjust for 0 V \pm 5 mV
CAL 09	CH1 Output level at full scale	Adjust for 10 V \pm 10 mV
CAL 10	CH1 20 dB attenuator	Adjust for 1 V \pm 1 mV
CAL 11	CH1 40 dB attenuator	Adjust for 0.1 V \pm 1 mV
CAL 12	CH1 10 dB attenuator	Adjust for 2.236 V ac \pm 10 mV
CAL 13	CH1 Not used.	
CAL 14	CH1 Not used.	
CAL 15	CH1 Not used.	
CAL 16	CH1 Level 0.1 MHz	Note reading
CAL 17	CH1 Level 33 MHz	Check reading
CAL 18	CH1 Level 1 MHz	Adjust for same reading
CAL 19	CH1 Level 2 MHz	Adjust for same reading
CAL 20	CH1 Level 4 MHz	Adjust for same reading
CAL 21	CH1 Level 5 MHz	Adjust for same reading
CAL 22	CH1 Level 10 MHz	Adjust for same reading
CAL 23	CH1 Level 15 MHz	Adjust for same reading
CAL 24	CH1 Level 20 MHz	Adjust for same reading
CAL 25	CH1 Level 25 MHz	Adjust for same reading
CAL 26	CH1 Level 30 MHz	Adjust for same reading
CAL 27	CH1 Level 32.5 MHz	Adjust for same reading
CAL 28	CH1 Level 35 MHz	Adjust for same reading
CAL 29	CH1 Level 37.5 MHz	Adjust for same reading
CAL 30	CH1 Level 40 MHz	Adjust for same reading
CAL 31	CH2 DC offset zero.	Adjust for 0 V \pm 5 mV
CAL 32	CH2 DC offset at + full scale.	Adjust for +10 V \pm 10 mV
CAL 33	CH2 DC offset at – full scale.	Check for –10 V \pm 3 %
CAL 34	CH2 Multiplier zero.	Adjust for minimum volts ac
CAL 35	CH2 Multiplier offset.	Adjust for 0 V \pm 5 mV
CAL 36	CH2 Waveform offset.	Adjust for 0 V \pm 5 mV
CAL 37	CH2 Output level at full scale	Adjust for 10 V \pm 10 mV
CAL 38	CH2 20 dB attenuator	Adjust for 1 V \pm 1 mV
CAL 39	CH2 40 dB attenuator	Adjust for 0.1 V \pm 1 mV
CAL 40	CH2 10 dB attenuator	Adjust for 2.236 V ac \pm 10 mV
CAL 41	CH2 Sum offset	Adjust for 0 V \pm 5 mV
CAL 42	CH2 SCM level at full-scale	Adjust for 5 V \pm 5 mV
CAL 43	CH2 AM level at full-scale	Adjust for 10 V \pm 10 mV
CAL 44	CH2 Level 0.1 MHz	Note reading
CAL 45	CH2 Level 33 MHz	Check reading
CAL 46	CH2 Level 1 MHz	Adjust for same reading
CAL 47	CH2 Level 2 MHz	Adjust for same reading
CAL 48	CH2 Level 4 MHz	Adjust for same reading
CAL 49	CH2 Level 5 MHz	Adjust for same reading
CAL 50	CH2 Level 10 MHz	Adjust for same reading
CAL 51	CH2 Level 15 MHz	Adjust for same reading
CAL 52	CH2 Level 20 MHz	Adjust for same reading
CAL 53	CH2 Level 25 MHz	Adjust for same reading
CAL 54	CH2 Level 30 MHz	Adjust for same reading
CAL 55	CH2 Level 32.5 MHz	Adjust for same reading

CAL 56	CH2 Level 35 MHz	Adjust for same reading
CAL 57	CH2 Level 37.5 MHz	Adjust for same reading
CAL 58	CH2 Level 40 MHz	Adjust for same reading
CAL 59	CH3 DC offset zero.	Adjust for 0 V \pm 5 mV
CAL 60	CH3 DC offset at + full scale.	Adjust for +10 V \pm 10 mV
CAL 61	CH3 DC offset at – full scale.	Check for –10 V \pm 3 %
CAL 62	CH3 Multiplier zero.	Adjust for minimum volts ac
CAL 63	CH3 Multiplier offset.	Adjust for 0 V \pm 5 mV
CAL 64	CH3 Waveform offset.	Adjust for 0 V \pm 5 mV
CAL 65	CH3 Output level at full scale	Adjust for 10 V \pm 10 mV
CAL 66	CH3 20 dB attenuator	Adjust for 1 V \pm 1 mV
CAL 67	CH3 40 dB attenuator	Adjust for 0.1 V \pm 1 mV
CAL 68	CH3 10 dB attenuator	Adjust for 2.236 V ac \pm 10 mV
CAL 69	CH3 Sum offset	Adjust for 0 V \pm 5 mV
CAL 70	CH3 SCM level at full-scale	Adjust for 5 V \pm 5 mV
CAL 71	CH3 AM level at full-scale	Adjust for 10 V \pm 10 mV
CAL 72	CH3 Level 0.1 MHz	Note reading
CAL 73	CH3 Level 33 MHz	Check reading
CAL 74	CH3 Level 1 MHz	Adjust for same reading
CAL 75	CH3 Level 2 MHz	Adjust for same reading
CAL 76	CH3 Level 4 MHz	Adjust for same reading
CAL 77	CH3 Level 5 MHz	Adjust for same reading
CAL 78	CH3 Level 10 MHz	Adjust for same reading
CAL 79	CH3 Level 15 MHz	Adjust for same reading
CAL 80	CH3 Level 20 MHz	Adjust for same reading
CAL 81	CH3 Level 25 MHz	Adjust for same reading
CAL 82	CH3 Level 30 MHz	Adjust for same reading
CAL 83	CH3 Level 32.5 MHz	Adjust for same reading
CAL 84	CH3 Level 35 MHz	Adjust for same reading
CAL 85	CH3 Level 37.5 MHz	Adjust for same reading
CAL 86	CH3 Level 40 MHz	Adjust for same reading
CAL 87	CH4 DC offset zero.	Adjust for 0 V \pm 5 mV
CAL 88	CH4 DC offset at + full scale.	Adjust for +10 V \pm 10 mV
CAL 89	CH4 DC offset at – full scale.	Check for –10 V \pm 3 %
CAL 90	CH4 Multiplier zero.	Adjust for minimum volts ac
CAL 91	CH4 Multiplier offset.	Adjust for 0 V \pm 5 mV
CAL 92	CH4 Waveform offset.	Adjust for 0 V \pm 5 mV
CAL 93	CH4 Output level at full scale	Adjust for 10 V \pm 10 mV
CAL 94	CH4 20 dB attenuator	Adjust for 1 V \pm 1 mV
CAL 95	CH4 40 dB attenuator	Adjust for 0.1 V \pm 1 mV
CAL 96	CH4 10 dB attenuator	Adjust for 2.236 V ac \pm 10 mV
CAL 97	CH4 Sum offset	Adjust for 0 V \pm 5 mV
CAL 98	CH4 SCM level at full-scale	Adjust for 5 V \pm 5 mV
CAL 99	CH4 AM level at full-scale	Adjust for 10 V \pm 10 mV
CAL 100	CH4 Level 0.1 MHz	Note reading
CAL 101	CH4 Level 33 MHz	Check reading
CAL 102	CH4 Level 1 MHz	Adjust for same reading
CAL 103	CH4 Level 2 MHz	Adjust for same reading
CAL 104	CH4 Level 4 MHz	Adjust for same reading
CAL 105	CH4 Level 5 MHz	Adjust for same reading
CAL 106	CH4 Level 10 MHz	Adjust for same reading
CAL 107	CH4 Level 15 MHz	Adjust for same reading
CAL 108	CH4 Level 20 MHz	Adjust for same reading
CAL 109	CH4 Level 25 MHz	Adjust for same reading
CAL 110	CH4 Level 30 MHz	Adjust for same reading

CAL 111	CH4 Level 32.5 MHz	Adjust for same reading
CAL 112	CH4 Level 35 MHz	Adjust for same reading
CAL 113	CH4 Level 37.5 MHz	Adjust for same reading
CAL 114	CH4 Level 40 MHz	Adjust for same reading
CAL 115	Clock calibrate	Adjust for 10.00000 MHz at SYNC OUT

Remote Calibration

Calibration of the instrument may be performed over the RS232 or GPIB interface. To completely automate the process the DVM and frequency meter will also need to be remote controlled and the controller will need to run a calibration program unique to this instrument.

The remote calibration commands allow a simplified version of manual calibration to be performed by issuing commands from the controller. The controller must send the CALADJ command repeatedly and read the DVM or frequency meter until the required result for the selected calibration step is achieved. The CALSTEP command is then issued to accept the new value and move to the next step.

While in remote calibration mode very little error checking is performed and it is the controller's responsibility to ensure that everything progresses correctly. Only the following commands should be used during calibration.

Important note

Using any other commands while in calibration mode may give unpredictable results and could cause the instrument to lock up, requiring the power to be cycled to regain control.

CALIBRATION <cpd> [,nrf]	The calibration control command. <cpd> can be one of three sub-commands:
START	Enter calibration mode; this command must be issued before any other calibration commands will be recognized.
SAVE	Finish calibration, save the new values and exit calibration mode.
ABORT	Finish calibration, do not save the new values and exit calibration mode.
	<nrf> represents the calibration password. The password is only required with CALIBRATION START and then only if a non-zero password has been set from the instrument's keyboard. The password will be ignored, and will give no errors, at all other times. It is not possible to set or change the password using remote commands.
CALADJ <nrf>	Adjust the selected calibration value by <nrf>. The value must be in the range -100 to +100. Once an adjustment has been completed and the new value is as required the CALSTEP command must be issued for the new value to be accepted.
CALSTEP	Step to the next calibration point.

For general information on remote operation and remote command formats, refer to the following chapter.

Chapter 17

Remote Operation

Title	Page
Introduction.....	17-2
Address and Baud Rate Selection.....	17-2
Remote/Local Operation.....	17-2
RS232 interface.....	17-3
Single Instrument RS232 Connections.....	17-3
Addressable RS232 Connections.....	17-3
RS232 Character Set.....	17-4
Addressable RS232 Interface Control Codes	17-4
Full List of Addressable RS232 Interface Control Codes	17-6
USB Interface	17-6
GPIB Interface	17-6
GPIB Subsets.....	17-7
GPIB IEEE Std. 488.2 Error Handling.....	17-7
GPIB Parallel Poll	17-7
Status Reporting.....	17-8
Standard Event Status and Standard Event Status Enable Registers	17-8
Status Byte Register and Service Request Enable Register.....	17-9
Power-On Settings.....	17-10
Remote commands.....	17-10
RS232 Remote Command Formats	17-10
GPIB Remote Command Formats.....	17-11
Command List	17-11
Channel Selection.....	17-12
Frequency and Period.....	17-12
Amplitude and DC Offset	17-12
Waveform Selection.....	17-13
Arbitrary Waveform Create and Delete	17-13
Arbitrary Waveform Editing	17-15
Waveform Sequence Control	17-17
Mode Commands	17-18
Input/Output Control.....	17-18
Modulation Commands.....	17-19
Synchronizing Commands	17-19
Status Commands.....	17-19
Miscellaneous Commands	17-21
Remote Command Summary.....	17-22

Introduction

The instrument can be remotely controlled via its RS232, USB or GPIB interfaces. When using RS232 it can either be the only instrument connected to the controller or it can be part of an addressable RS232 system which permits up to 32 instruments to be addressed from one RS232 port.

Some of the following sections are general and apply to all 4 modes (single instrument RS232, addressable RS232, USB and GPIB); others are clearly only relevant to a particular interface or mode. It is only necessary to read the general sections plus those specific to the intended remote control mode.

Address and Baud Rate Selection

For successful operation, each instrument connected to the GPIB or addressable RS232 system must be assigned a unique address and, in the case of addressable RS232, all must be set to the same Baud rate.

The instrument's remote address for operation on both the RS232 and GPIB interfaces is set via the `remote` menu on the **UTILITY** screen.

```

REMOTE:
♦interface: RS232
♦address: 05
♦baud rate: 9600

```

With `interface` selected with the `interface` soft-key, the selection can be stepped between RS232, USB and GPIB with successive presses of the soft-key, the cursor keys or by using the rotary control.

With `address` selected, the soft-key, cursor keys or rotary control can be used to set the address; the address setting is ignored in USB mode.

With `baud rate` selected, the soft-key, cursor keys or rotary control can be used to set the baud rate for the RS232 interface.

When operating on the GPIB all device operations are performed through a single primary address; no secondary addressing is used. Note also that GPIB address 31 is not allowed by the IEEE 488 standards but it is possible to select it as an RS232 address.

Remote/Local Operation

At power-on the instrument will be in the local state with the **REMOTE** lamp off. In this state all keyboard operations are possible. When the instrument is addressed to listen and a command is received the remote state will be entered and the **REMOTE** lamp will illuminate. In this state the keyboard is locked out and only remote commands will be processed. The instrument may be returned to the local state by pressing the **LOCAL** key; however, the effect of this action will remain only until the instrument is addressed again or receives another character from the interface, when the remote state will once again be entered.

RS232 interface

The 9-way D-type serial interface connector is located on the instrument rear panel. The pin connections are as shown in chapter 3, *Connections*.

Single Instrument RS232 Connections

For single instrument remote control only pins 2, 3 and 5 are connected to the PC. However, for correct operation links must be made in the connector at the PC end between pins 1, 4 and 6 and between pins 7 and 8; see diagram. Pins 7 and 8 of the instrument must **not** be connected to the PC, i.e. do not use a fully wired 9-way cable.

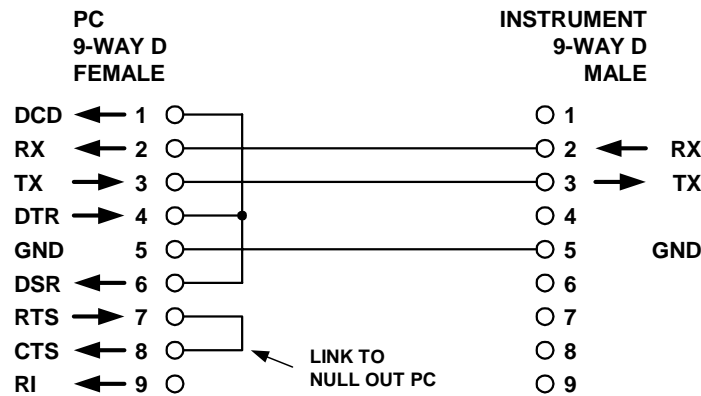

Figure 17-1. Single Instrument RS232 Connections

shc0010f.emf

Baud Rate is set as described above in *Address and Baud rate selection*; the other parameters are fixed as follows:

Start Bits: 1
Data Bits: 8
Parity: None
Stop Bits: 1

Addressable RS232 Connections

For addressable RS232 operation pins 7, 8 and 9 of the instrument connector are also used. Using a simple cable assembly, a 'daisy chain' connection system between any number of instruments, up to the maximum of 32 can be made, as shown below:

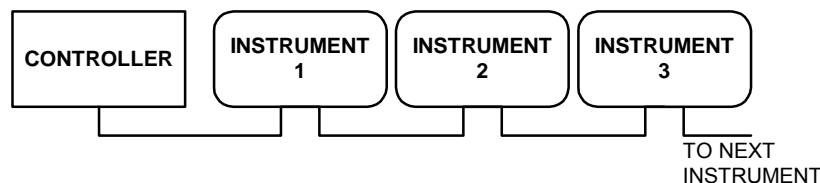

Figure 17-2. RS232 Daisy-Chain Instruments

shc0011f.emf

The daisy chain consists of the transmit data (TXD), receive data (RXD) and signal ground lines only. There are no control/handshake lines. This makes XON/XOFF protocol essential and allows the interconnection between instruments to contain just 3 wires. The wiring of the adaptor cable is shown below:

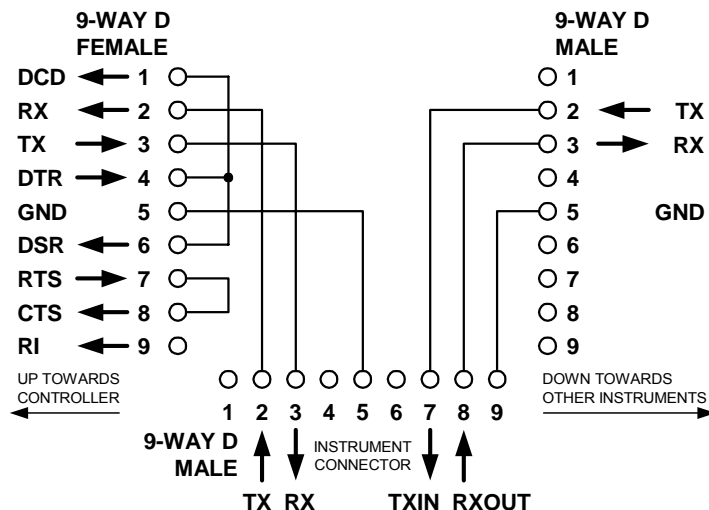

Figure 17-3. RS232 Daisy-Chain Connector Wiring

shc0012f.emf

All instruments on the interface must be set to the same baud rate and all must be powered on, otherwise instruments further down the daisy chain will not receive any data or commands.

The other parameters are fixed as follows:

- Start Bits: 1
- Data Bits: 8
- Parity: None
- Stop Bits: 1

RS232 Character Set

Because of the need for XON/XOFF handshake it is possible to send ASCII coded data only; binary blocks are not allowed. Bit 7 of ASCII codes is ignored, i.e. assumed to be low. No distinction is made between upper and lower case characters in command mnemonics and they may be freely mixed. The ASCII codes below 20H (space) are reserved for addressable RS232 interface control. In this manual 20H, etc. means 20 in hexadecimal

Addressable RS232 Interface Control Codes

All instruments intended for use on the addressable RS232 bus use the following set of interface control codes. Codes between 00H and 1FH which are not listed here as having a particular meaning are reserved for future use and will be ignored. Mixing interface control codes inside instrument commands is not allowed except as stated below for CR and LF codes and XON and XOFF codes.

When an instrument is first powered on it will automatically enter the non-addressable mode. In this mode the instrument is not addressable and will not respond to any address commands. This allows the instrument to function as a normal RS232 controllable device. This mode may be locked by sending the Lock Non-Addressable mode control code, 04H. The controller and instrument can now freely use all 8 bit codes and binary blocks but all interface control codes are ignored. To return to addressable mode the instrument must be powered off.

To enable addressable mode after an instrument has been powered on the Set Addressable Mode control code, 02H, must be sent. This will then enable all instruments connected to the addressable RS232 bus to respond to all interface control codes. To

return to non-addressable mode the Lock Non-Addressable mode control code must be sent which will disable addressable mode until the instruments are powered off.

Before an instrument is sent a command it must be addressed to listen by sending the Listen Address control code, 12H, followed by a single character which has the lower 5 bits corresponding to the unique address of the required instrument, e.g. the codes A-Z or a-z give the addresses 1–26 inclusive while @ is address 0 and so on. Once addressed to listen the instrument will read and act upon any commands sent until the listen mode is cancelled.

Because of the asynchronous nature of the interface it is necessary for the controller to be informed that an instrument has accepted the listen address sequence and is ready to receive commands. The controller will therefore wait for Acknowledge code, 06H, before sending any commands. The addressed instrument will provide this Acknowledge code. The controller should time out and try again if no Acknowledge code is received within 5 seconds.

Listen mode will be cancelled by any of the following interface control codes being received:

- 12H Listen Address followed by an address not belonging to this instrument.
- 14H Talk Address for any instrument.
- 03H Universal unaddress control code.
- 04H Lock Non-Addressable mode control code.
- 18H Universal Device Clear.

Before a response can be read from an instrument it must be addressed to talk by sending the Talk Address control code, 14H, followed by a single character which has the lower 5 bits corresponding to the unique address of the required instrument, as for the listen address control code above. Once addressed to talk the instrument will send the response message it has available, if any, and then exit the talk addressed state. Only one response message will be sent each time the instrument is addressed to talk.

Talk mode will be cancelled by any of the following interface control codes being received:

- 12H Listen Address for any instrument.
- 14H Talk Address followed by an address not belonging to this instrument.
- 03H Universal Unaddress control code.
- 04H Lock Non-Addressable mode control code.
- 18H Universal Device Clear.

Talk mode will also be cancelled when the instrument has completed sending a response message or has nothing to say.

The interface code 0AH (LF) is the universal command and response terminator; it must be the last code sent in all commands and will be the last code sent in all responses.

The interface code 0DH (CR) may be used as required to aid the formatting of commands; it will be ignored by all instruments. Most instruments will terminate responses with CR followed by LF.

The interface code 13H (XOFF) may be sent at any time by a listener (instrument or controller) to suspend the output of a talker. The listener must send 11H (XON) before the talker will resume sending. This is the only form of handshake control supported by the addressable RS232 mode.

Full List of Addressable RS232 Interface Control Codes

02H	Set Addressable Mode.
03H	Universal Unaddress control code.
04H	Lock Non-Addressable mode control code.
06H	Acknowledge that listen address received.
0AH	Line Feed (LF); used as the universal command and response terminator.
0DH	Carriage Return (CR); formatting code, otherwise ignored.
11H	Restart transmission (XON).
12H	Listen Address – must be followed by an address belonging to the required instrument.
13H	Stop transmission (XOFF).
14H	Talk Address – must be followed by an address belonging to the required instrument.
18H	Universal Device Clear.

USB Interface

The USB interface allows the instrument to be controlled via a PC's USB port. The instrument is supplied with a CD-ROM containing drivers for various versions of Windows, including Win98 and 2000. Any driver updates are available via the Fluke . The CD-ROM also contains a .pdf file with information and details of the software installation procedure.

Installation of the driver is achieved by connecting the instrument to a PC via a standard USB cable. The Windows' plug and play functions should automatically recognize the addition of new hardware attached to the USB interface and if this is the first time the connection has been made, prompt for the location of a suitable driver. Provided that the standard Windows prompts are followed correctly Windows will install the appropriate driver. The driver will remain installed on the PC and should be called automatically each time the instrument is connected to the PC via USB in the future.

When the instrument is connected to a PC, with the correct driver installed, there will be an exchange of information between PC and instrument called the Enumeration process; this 'connects' the two together. It is possible to connect several instruments of the same type at the same time and the PC will be able to communicate with each one individually. To make it easy for an application program to direct commands to the required instrument the driver interrogates each instrument as it is connected to get its address. The application program can then access the instruments individually by that address.

The waveform design software supplied with this generator has been enhanced to permit downloads to the instrument using USB. For users wishing to write their own application software for USB communication with the generator, the relevant information is supplied on the CD-ROM containing the drivers themselves.

GPIB Interface

The 24-way GPIB connector is located on the instrument rear panel. The pin connections are as specified in IEEE Std. 488.1–1987 and the instrument complies with IEEE Std. 488.1–1987 and IEEE Std. 488.2–1987.

GPIB Subsets

This instrument contains the following IEEE 488.1 subsets:

Source Handshake	SH1
Acceptor Handshake	AH1
Talker	T6
Listener	L4
Service Request	SR1
Remote Local	RL1
Parallel Poll	PP1
Device Clear	DC1
Device Trigger	DT1
Controller	C0
Electrical Interface	E2

GPIB IEEE Std. 488.2 Error Handling

The IEEE 488.2 UNTERMINATED error (addressed to talk with nothing to say) is handled as follows. If the instrument is addressed to talk and the response formatter is inactive and the input queue is empty then the UNTERMINATED error is generated. This will cause the Query Error bit to be set in the Standard Event Status Register, a value of 3 to be placed in the Query Error Register and the parser to be reset .

The IEEE 488.2 INTERRUPTED error is handled as follows. If the response formatter is waiting to send a response message and a <PROGRAM MESSAGE TERMINATOR> has been read by the parser or the input queue contains more than one END message then the instrument has been INTERRUPTED and an error is generated. This will cause the Query Error bit to be set in the Standard Event Status Register, a value of 1 to be placed in the Query Error Register and the response formatter to be reset thus clearing the output queue. The parser will then start parsing the next <PROGRAM MESSAGE UNIT> from the input queue.

The IEEE 488.2 DEADLOCK error is handled as follows. If the response formatter is waiting to send a response message and the input queue becomes full then the instrument enters the DEADLOCK state and an error is generated. This will cause the Query Error bit to be set in the Standard Event Status Register, a value of 2 to be placed in the Query Error Register and the response formatter to be reset thus clearing the output queue. The parser will then start parsing the next <PROGRAM MESSAGE UNIT> from the input queue.

The section below on *Status Reporting* provides further information on these three error handling processes.

GPIB Parallel Poll

Complete parallel poll capabilities are offered on this generator. The Parallel Poll Enable Register is set to specify which bits in the Status Byte Register are to be used to form the *ist* local message. The Parallel Poll Enable Register is set by the *PRE <nrf> command and read by the *PRE? command. The value in the Parallel Poll Enable Register is ANDed with the Status Byte Register; if the result is zero then the value of *ist* is 0; otherwise the value of *ist* is 1.

The instrument must also be configured so that the value of *ist* can be returned to the controller during a parallel poll operation. The instrument is configured by the controller sending a Parallel Poll Configure command (PPC) followed by a Parallel Poll Enable command (PPE).

The bits in the PPE command are as follows:

bit 7 =	x	don't care
bit 6 =	1	parallel poll enable
bit 5 =	1	
bit 4 =	0	
bit 3 =	sense	sense of the response bit; 0 = low, 1 = high
bit 2 =	?	bit position of the response
bit 1 =	?	
bit 0 =	?	

For example: to return the RQS bit (bit 6 of the Status Byte Register) as a 1 when true and a 0 when false in bit position 1 in response to a parallel poll operation, send the following commands:

*PRE 64<pmt>, then PPC followed by 69H (PPE)

The parallel poll response from the generator will then be 00H if RQS is 0 and 01H if RQS is 1.

During parallel poll response the DIO interface lines are resistively terminated (passive termination). This allows multiple devices to share the same response bit position in either wired-AND or wired-OR configuration, see IEEE 488.1 for more information.

Status Reporting

This section describes the complete status model of the instrument. Note that some registers are specific to the GPIB section of the instrument and are of limited use in an RS232 environment.

Standard Event Status and Standard Event Status Enable Registers

These two registers are implemented as required by the IEEE std. 488.2.

Any bits set in the Standard Event Status Register which correspond to bits set in the Standard Event Status Enable Register will cause the ESB bit to be set in the Status Byte Register.

The Standard Event Status Register is read and cleared by the *ESR? command. The Standard Event Status Enable register is set by the *ESE <nrf> command and read by the *ESE? command.

- Bit 7 Power On. Set when power is first applied to the instrument.
- Bit 6 Not used.
- Bit 5 Command Error. Set when a syntax type error is detected in a command from the bus. The parser is reset and parsing continues at the next byte in the input stream.
- Bit 4 Execution Error. Set when an error is encountered while attempting to execute a completely parsed command. The appropriate error number will be reported in the Execution Error Register.
- Bit 3 Not used.
- Bit 2 Query Error. Set when a query error occurs. The appropriate error number will be reported in the Query Error Register as listed below.
 1. Interrupted error
 2. Deadlock error
 3. Unterminated error
- Bit 1 Not used.
- Bit 0 Operation Complete. Set in response to the *OPC command.

Status Byte Register and Service Request Enable Register

These two registers are implemented as required by the IEEE std. 488.2.

Any bits set in the Status Byte Register which correspond to bits set in the Service Request Enable Register will cause the RQS/MSS bit to be set in the Status Byte Register, thus generating a Service Request on the bus.

The Status Byte Register is read either by the *STB? command, which will return MSS in bit 6, or by a Serial Poll which will return RQS in bit 6. The Service Request Enable register is set by the *SRE <nrf> command and read by the *SRE? command.

- Bit 7 Not used.
- Bit 6 RQS/MSS. This bit, as defined by IEEE Std. 488.2, contains both the Requesting Service message and the Master Status Summary message.
RQS is returned in response to a Serial Poll and MSS is returned in response to the *STB? command.
- Bit 5 ESB. The Event Status Bit. This bit is set if any bits set in the Standard Event Status Register correspond to bits set in the Standard Event Status Enable Register.
- Bit 4 MAV. The Message Available Bit. This will be set when the instrument has a response message formatted and ready to send to the controller. The bit will be cleared after the Response Message Terminator has been sent.
- Bit 3 Not used.
- Bit 2 Not used.
- Bit 1 Not used.
- Bit 0 Not used.

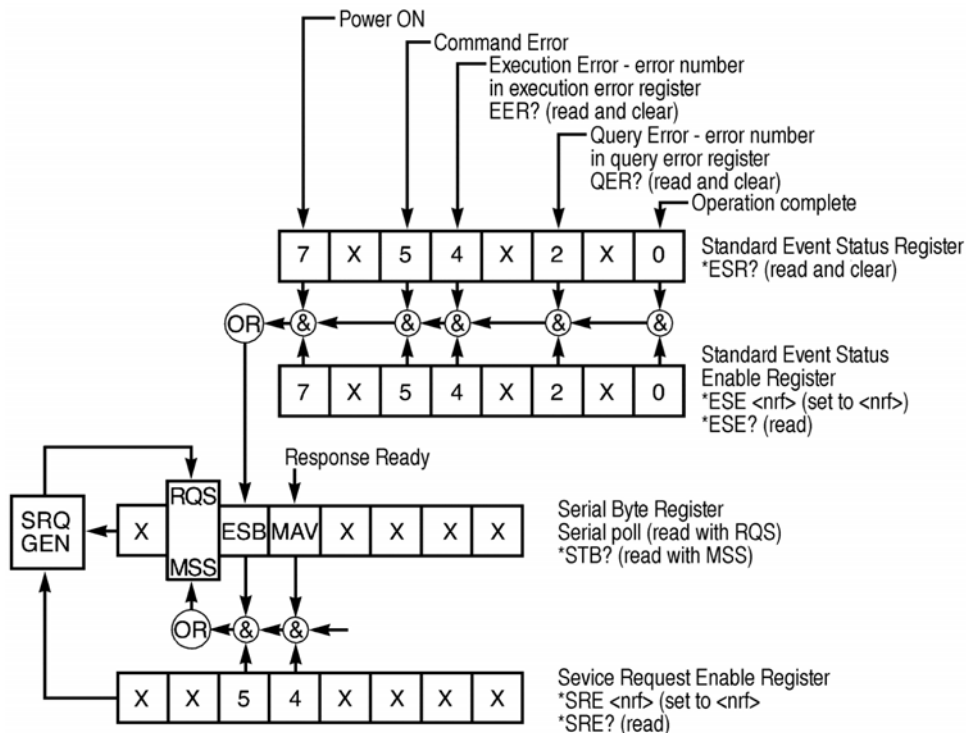

Figure 17-4. Status Model

shc0013f.gif

Power-On Settings

The following instrument status values are set at power-on:

Status Byte Register	= 0
Service Request Enable Register †	= 0
Standard Event Status Register	= 128 (pon bit set)
Standard Event Status Enable Register †	= 0
Execution Error Register	= 0
Query Error Register	= 0
Parallel Poll Enable Register †	= 0

† Registers marked thus are specific to the GPIB section of the instrument and are of limited use in an RS232 environment.

The instrument will be in local state with the keyboard active.

The instrument parameters at power on are determined on the `POWER ON SETTING` screen accessed from the `UTILITY` menu. If `restore last setup` or `recall store no. nn` has been set and a defined state is required by the controller at start up then the command `*RST` should be used to load the system defaults.

If for any reason an error is detected at power up in the nonvolatile ram a warning will be issued and all settings will be returned to their default states as for a `*RST` command.

Remote commands

RS232 Remote Command Formats

Serial input to the instrument is buffered in a 256 byte input queue which is filled, under interrupt, in a manner transparent to all other instrument operations. The instrument will send `XOFF` when approximately 200 characters are in the queue. `XON` will be sent when approximately 100 free spaces become available in the queue after `XOFF` was sent. This queue contains raw (un-parsed) data which is parsed as it is required. Commands and queries are executed in order and the parser will not start a new command until any previous command or query is complete.

In non-addressable RS232 mode responses to commands or queries are sent immediately; there is no output queue. In addressable mode the response formatter will wait, indefinitely if necessary, until the instrument is addressed to talk and the complete response message has been sent, before allowing the parser to start the next command in the input queue.

Commands must be sent as specified in the commands list and must be terminated with the command terminator code `0AH` (Line Feed, LF). Commands may be sent in groups with individual commands separated from each other by the code `3BH` (semicolon). The group must be terminated with command terminator `0AH` (Line Feed, LF).

Responses from the instrument to the controller are sent as specified in the commands list. Each response is terminated by `0DH` (Carriage Return, CR) followed by `0AH` (Line Feed, LF).

<WHITE SPACE> is defined as character codes `00H` to `20H` inclusive with the exception of those which are specified as addressable RS232 control codes.

<WHITE SPACE> is ignored except in command identifiers (thus, for example, `*C LS` is not equivalent to `*CLS`).

The high bit of all characters is ignored.

The commands are not case-sensitive.

GPIB Remote Command Formats

GPIB input to the instrument is buffered in a 256 byte input queue which is filled, under interrupt, in a manner transparent to all other instrument operations. The queue contains raw (un-parsed) data which is taken by the parser as required. Commands (and queries) are executed in order and the parser will not start a new command until any previous command or query is complete. There is no output queue which means that the response formatter will wait, indefinitely if necessary, until the instrument is addressed to talk and the complete response message has been sent, before the parser is allowed to start the next command in the input queue.

Commands are sent as <PROGRAM MESSAGES> by the controller, each message consisting of zero or more <PROGRAM MESSAGE UNIT> elements separated by <PROGRAM MESSAGE UNIT SEPARATOR> elements.

A <PROGRAM MESSAGE UNIT> is any of the commands in the remote commands list.

A <PROGRAM MESSAGE UNIT SEPARATOR> is the semi-colon character ';' (3BH).

<PROGRAM MESSAGES> are separated by <PROGRAM MESSAGE TERMINATOR> elements which may be any of the following:

NL The new line character (0AH)

NL^END The new line character with the END message

^END The END message with the last character of the message

Responses from the instrument to the controller are sent as <RESPONSE MESSAGES>.

A <RESPONSE MESSAGE> consists of one <RESPONSE MESSAGE UNIT> elements followed by a <RESPONSE MESSAGE TERMINATOR> element.

A <RESPONSE MESSAGE TERMINATOR> is the new line character with the END message NL^END.

Each query produces a specific <RESPONSE MESSAGE> which is listed along with the command in the remote commands list.

<WHITE SPACE> is ignored except in command identifiers (thus, for example, *C LS is not equivalent to *CLS).

<WHITE SPACE> is defined as character codes 00H to 20H inclusive with the exception of the NL character (0AH).

The high bit of all characters is ignored.

The commands are not case-sensitive.

Command List

This section lists all commands and queries implemented in this instrument. The commands are listed in alphabetical order within the function groups.

Note that there are no dependent parameters, coupled parameters, overlapping commands, expression program data elements or compound command program headers; each command is completely executed before the next command is started. All commands are sequential and the operation complete message is generated immediately after execution in all cases.

The following nomenclature is used:

- <rmt> <RESPONSE MESSAGE TERMINATOR>
- <cpd> <CHARACTER PROGRAM DATA>: a short mnemonic or string such as ON or OFF.
- <nrf> A number in any format. For example, 12, 12.00, 1.2 e 1 and 120 e-1 are all accepted as the number 12.
Any number, when received, is converted to the required precision consistent with the use, then rounded up to obtain the value of the command.
- <nr1> A number with no fractional part, i.e. an integer.
- [...] Any item(s) enclosed in these brackets are optional parameters.
If more than one item is enclosed then all or none of the items are required.

The commands which begin with an asterisk (*) are those specified by IEEE Std. 488.2 as Common Commands. All will function when used on the RS232 interface but some have little applicability here.

Channel Selection

Most commands act on a particular channel of the generator. The following command is used to select the required channel. Subsequent commands will change only the specified parameter on the selected channel.

- SETUPCH <nrf> Select channel <nrf> as the destination for subsequent commands.
The value of <nrf> ranges from 1 to the highest channel number in the instrument.

Frequency and Period

These commands set the frequency or period of the generator main output and are equivalent to pressing the **FREQ** key and editing that screen.

- WAVFREQ <nrf> Set the waveform frequency to <nrf> Hz.
- WAVPER <nrf> Set the waveform period to <nrf> sec.
- CLKFREQ <nrf> Set the arbitrary sample clock freq to <nrf> Hz.
- CLKPER <nrf> Set the arbitrary sample clock period to <nrf> sec.
- WFMCLKSRC <cpd> Set the playback clock source of the selected waveform to <INT> or <EXT>.

Amplitude and DC Offset

- AMPL <nrf> Set the amplitude to <nrf> in the units as specified by the AMPUNIT command.
- AMPUNIT <cpd> Set the amplitude units to <VPP>, <VRMS> or <DBM>.
- ZLOAD <cpd> Set the output load, which the generator is to assume for amplitude and dc offset entries, to <50> (50Ω), <600> (600Ω) or <OPEN>.
- DCOFFS <nrf> Set the dc offset to <nrf> Volts.

Waveform Selection

WAVE <cpd>	Select the output waveform as <SINE>, <SQUARE>, <TRIANG>, <DC>, <POSRMP>, <NEGRMP>, <COSINE>, <HAVSIN>, <HAVCOS>, <SINC>, <PULSE>, <PULSTRN>, <ARB> or <SEQ>.
PULSPER <nrf>	Set the pulse period to <nrf> sec.
PULSWID <nrf>	Set the pulse width to <nrf> sec.
PULSDLY <nrf>	Set the pulse delay to <nrf> sec.
PULTRNLEN <nrf>	Set the number of pulses in the pulse-train to <nrf>.
PULTRNPER <nrf>	Set the pulse-train period to <nrf> sec.
PULTRNBASE <nrf>	Set the pulse-train base line to <nrf> Volts.
PULTRNLEV <nrf1>, <nrf2>	Set the level of pulse-train pulse number <nrf1> to <nrf2> Volts.
PULTRNWID <nrf1>, <nrf2>	Set the width of pulse-train pulse number <nrf1> to <nrf2> sec.
PULTRNDLY <nrf1>, <nrf2>	Set the delay of pulse-train pulse number <nrf1> to <nrf2> sec.
PULTRNMAKE	Makes the pulse-train and runs it - similar to the WAVE PULSTRN command.
ARB <cpd>	Select an arbitrary waveform for output. <cpd> must be the name of an existing arbitrary waveform. Backup memory is always used as the source of the arb. The arb will be copied to the channel memory if necessary.
ARBLIST?	Returns a list of all arbitrary waveforms on the memory card. Each will return a name and length in the following form <cpd>, <nr1>. The list will end with <rmt>.
CF?	Interrogates the memory card. Returns available space in MB, e.g. 21.5MB. Returns 0.0MB if either WAVES or SETUP directories are full; returns -1 if no memory card is found.
CFSIZE?	Returns the formatted capacity of the memory card in MBytes.
CFLABEL?	Returns the volume label of the memory card.

Arbitrary Waveform Create and Delete

Care should be take to ensure that all channels in the instrument are running in CONTINUOUS mode before using commands from this section. Failure to observe this restriction may give unexpected results.

ARBDELETE <cpd>	Delete the arbitrary waveform <cpd> from backup memory.
-----------------	---

ARBCLR <cpd>	Delete the arb <cpd> from channel memory. The backup memory is not changed.
ARBCREATE <cpd>,<nrf>	Create a new, blank arbitrary waveform with name <cpd> and length <nrf> points.
ARBDEFCSV <cpd>,<nrf>,<csv ascii data>	<p>Define a new or existing arbitrary waveform with name <cpd> and length <nrf> and load with the data in <csv ascii data>. If the arbitrary waveform does not exist it will be created. If it does exist the length will be checked against that specified and a warning will be issued if they are different. The edit limits will be set to the extremes of the waveform.</p> <p>The data consists of ascii coded values, in the range -2048 to +2047, for each point. The values are separated by a comma character and the data ends with <pmt>. If less data is sent than the number of points in the waveform the old data is retained from the point where the new data ends. If more data is sent the surplus is discarded.</p>
ARBDEF <cpd>,<nrf>,<bin data block>	<p>Define a new or existing arbitrary waveform with name <cpd> and length <nrf> and load with the data in <bin data block>. If the arbitrary waveform does not exist it will be created. If it does exist the length will be checked against that specified and a warning will be issued if they are different. The edit limits will be set to the extremes of the waveform.</p> <p>The data consists of two bytes per point with no characters between bytes or points. The point data is sent high byte first. The data block has a header which consists of the # character followed by several ascii-coded numeric characters. The first of these defines the number of ascii characters to follow and the following characters define the length of the binary data in bytes. If less data is sent than the number of points in the waveform the old data is retained from the point where the new data ends. If more data is sent the surplus is discarded.</p> <p>This command cannot be used over the RS232 interface since it contains a binary data block.</p>

Arbitrary Waveform Editing

Care should be taken to ensure that all channels in the instrument are running in CONTINUOUS mode before using commands from this section. Failure to observe this restriction may give unexpected results.

<code>ARBEDLMTS <nrf1>,<nrf2></code>	<p>Set the limits for the arbitrary waveform editing functions to start at <code><nrf1></code> and stop at <code><nrf2></code>.</p> <p>If both values are set to 0 the commands which use them will automatically place them at the start and end points of the relevant waveform. This automatic mode will remain in effect until the <code>ARBEDLMTS</code> command is issued again with non zero values. The automatic mode is always selected at power up.</p>
<code>ARBDATACSV <cpd>, <csv ascii data></code>	<p>Load data to an existing arbitrary waveform. <code><cpd></code> must be the name of an existing arbitrary waveform.</p> <p>The data consists of ascii coded values, in the range -2048 to +2047, for each point. The values are separated by a comma character and the data ends with <code><pmt></code>. The data is entered into the arbitrary waveform between the points specified by the <code>ARBEDLMTS</code> command. If less data is sent than the number of points between the limits the old data is retained from the point where the new data ends. If more data is sent the surplus is discarded.</p>
<code>ARBADATA <cpd>, <bin data block></code>	<p>Load data to an existing arbitrary waveform. <code><cpd></code> must be the name of an existing arbitrary waveform.</p> <p>The data consists of two bytes per point with no characters between bytes or points. The point data is sent high byte first. The data block has a header which consists of the <code>#</code> character followed by several ascii coded numeric characters. The first of these defines the number of ascii characters to follow and these following characters define the length of the binary data in bytes.</p> <p>The data is entered into the arbitrary waveform between the points specified by the <code>ARBEDLMTS</code> command. If less data is sent than the number of points between the limits the old data is retained from the point where the new data ends. If more data is sent the surplus is discarded.</p> <p>This command cannot be used over the RS232 interface since it contains a binary data block.</p>

ARBDATACSV? <cpd>	<p>Returns the data from an existing arbitrary waveform.</p> <p><cpd> must be the name of an existing arbitrary waveform.</p> <p>The data consists of ascii coded values as specified for the ARBDATACSV command. The data is sent from the arbitrary waveform between the points specified by the ARBEDLMTS command.</p>
ARBDATA? <cpd>	<p>Returns the data from an existing arbitrary waveform.</p> <p><cpd> must be the name of an existing arbitrary waveform.</p> <p>The data consists of binary coded values as specified for the ARBDATA command. The data is sent from the arbitrary waveform between the points specified by the ARBEDLMTS command.</p> <p>This command cannot be used over the RS232 interface since it contains a binary data block.</p>
ARBRESIZE <cpd>, <nrf>	Change the size of arbitrary waveform <cpd> to <nrf>.
ARBRENAME <cpd1>, <cpd2>	Change the name of arbitrary waveform <cpd1> to <cpd2>.
ARBPOINT <cpd>, <nrf1>, <nrf2>	Set the waveform point at address <nrf1> in arbitrary waveform <cpd> to <nrf2>.
ARBLINE <cpd>, <nrf1>, <nrf2>, <nrf3>, <nrf4>	Draw a line in arbitrary waveform <cpd> from start address and data <nrf1> and <nrf2> to stop address and data <nrf3> and <nrf4>.
ARBINSSTD <cpd1>, <cpd2>, <nrf1>, <nrf2>	<p>Insert the standard waveform <cpd2> into the arbitrary waveform <cpd1> from start address <nrf1> to stop address <nrf2>.</p> <p><cpd2> must be one of <SINE>, <SQUARE>, <TRIANG>, <DC>, <POSRMP>, <NEGRMP>, <COSINE>, <HAVSIN>, <HAVCOS>, or <SINC> and <cpd1> must be an existing arbitrary waveform.</p>
ARBINSARB <cpd1>, <cpd2>, <nrf1>, <nrf2>	<p>Insert the arbitrary waveform <cpd2> into arbitrary waveform <cpd1>.</p> <p>Use that part of <cpd2> specified by the ARBEDLMTS command and insert from start address <nrf1> to the stop address <nrf2>.</p> <p><cpd1> and <cpd2> must both be existing arbitrary waveforms but they cannot be the same waveform.</p>

ARBCOPY <cpd>, <nrf1>, <nrf2>, <nrf3>	Block copy in arbitrary waveform <cpd> the data from start address <nrf1> to stop address <nrf2> to destination address <nrf3>.
ARBAMPL <cpd>, <nrf1>, <nrf2>, <nrf3>	Adjust the amplitude of arbitrary waveform <cpd> in the address range <nrf1> to <nrf2> by the factor <nrf3>.
ARBOFFSET <cpd>, <nrf1>, <nrf2>, <nrf3>	Move the data in arbitrary waveform <cpd> in the address range <nrf1> to <nrf2> by the offset <nrf3>.
ARBINVERT <cpd>, <nrf1>, <nrf2>	Invert arbitrary waveform <cpd> in the address range <nrf1> to <nrf2>.
ARBLEN? <cpd>	Returns the length, in points, of the arbitrary waveform <cpd>. If the waveform does not exist the return value will be 0.
POSNMKRCLR <cpd>	Clear all position markers from arbitrary waveform <cpd>.
POSNMKRSET <cpd>, <nrf>	Set the position marker at address <nrf> in arbitrary waveform <cpd> to 1 (high).
POSNMKRRES <cpd>, <nrf>	Clear the position marker at address <nrf> in arbitrary waveform <cpd> to 0 (low).
POSNMKRPAT <cpd1>, <nrf1>, <nrf2>, <cpd2>	Put the pattern <cpd2> into the arbitrary waveform <cpd1> from start address <nrf1> to stop address <nrf2>. The pattern may contain up to 16 entries of '1' or '0'; no other characters are allowed.

Waveform Sequence Control

SEQWFM <nrf>, <cpd>	Set the 'waveform' parameter for sequence segment <nrf> to <cpd>. <cpd> must be the name of an existing arbitrary waveform.
SEQSTEP <nrf>, <cpd>	Set the 'step on' parameter for sequence segment <nrf> to <COUNT>, <TRGEDGE> or <TRGLEV>.
SEQCNT <nrf1>, <nrf2>	Set count for sequence segment <nrf1> to <nrf2>.
SEQSEG <nrf>, <cpd>	Set the status of sequence segment <nrf> to <ON> or <OFF>.

Mode Commands

MODE <cpd>	Set the mode to <CONT>, <GATE>, <TRIG>, <SWEEP> or <TONE>.
BSTCNT <nrf>	Set the burst count to <nrf>.
PHASE <nrf>	Set the generator phase to <nrf> degrees. This parameter is used for setting the trigger/gate mode start/stop phase and the phase difference when synchronizing channels.
TONEEND <nrf>	Delete tone frequency number <nrf> thus defining the end of the list.
TONEFREQ <nrf1>, <nrf2>, <nrf3>	Set tone frequency number <nrf1> to <nrf2> Hz. The third parameter sets the tone type; 1 will give Trig, 2 will give FSK, any other value gives Gate type.
SWPSTARTFRQ <nrf>	Set the sweep start frequency to <nrf> Hz.
SWPSTOPFRQ <nrf>	Set the sweep stop frequency to <nrf> Hz.
SWPCENTFRQ <nrf>	Set the sweep centre frequency to <nrf> Hz.
SWPSPAN <nrf>	Set the sweep frequency span to <nrf> Hz.
SWPTIME <nrf>	Set the sweep time to <nrf> sec.
SWPTYPE <cpd>	Set the sweep type to <CONT>, <TRIG> or <THLDRST>.
SWPDIRN <cpd>	Set the sweep direction to <UP>, <DOWN>, <UPDN> or <DNUP>.
SWPSYNC <cpd>	Set the sweep sync <ON> or <OFF>.
SWPSPACING <cpd>	Set the sweep spacing to <LIN> or <LOG>.
SWPMKR <nrf>	Set the sweep marker to <nrf> Hz.

Input/Output Control

OUTPUT <cpd>	Set the main output <ON>, <OFF>, <NORMAL> or <INVERT>.
SYNCOUT <cpd>	Set the sync output <ON>, <OFF>, <AUTO>, <WFMSYNC>, <POSNMKR>, <BSTDONE>, <SEQSYNC>, <TRIGGER>, <SWPSYNC> or <PHASLOC>.
TRIGOUT <cpd>	Set the trig output to <AUTO>, <WFMEEND>, <POSNMKR>, <SEQSYNC> or <BSTDONE>.
TRIGIN <cpd>	Set the trig input to <INT>, <EXT>, <MAN>, <PREV>, <NEXT>, <POS> or <NEG>.
TRIGLEV <nrf>	Set the trigger threshold level to <nrf> volts.
TRIGPER <nrf>	Set the internal trigger generator period to <nrf> sec.

FORCETRIG Force a trigger to the selected channel.
Will function with any trigger source except MANUAL specified.

Modulation Commands

MOD <cpd> Set the modulation source to <OFF>, <EXT> or <PREV>.

MODTYPE <cpd> Set the modulation type to <AM> or <SCM>.

AMDEPTH <nrf> Set the depth for amplitude modulation to <nrf> %.

SCMLEVEL <nrf> Set the level for SCM to <nrf> volts.

SUM <cpd> Set the sum source to <OFF>, <EXT> or <PREV>.

SUMRATIO <nrf> Set the sum ratio to <nrf>.

Synchronizing Commands

REFCLK <cpd> Set the **REF CLK IN/OUT** to <IN>, <OUT>, <MASTER> or <SLAVE>.

ABORT Aborts an external phase synchronizing operation.

PHASE <nrf> Set the generator phase to <nrf> degrees. This parameter is used for setting the trigger/gate mode start/stop phase and the phase difference when synchronizing channels.

LOCKMODE <cpd> Set the channel lock mode to <INDEP>, <MASTER>, <FTRACK> or <SLAVE>.

LOCKSTAT <cpd> Set the inter-channel synchronization status to <ON> or <OFF>.

Status Commands

*CLS Clear status. Clears the Standard Event Status Register, Query Error Register and Execution Error Register. This indirectly clears the Status Byte Register.

*ESE <nrf> Set the Standard Event Status Enable Register to the value of <nrf>.

*ESE? Returns the value in the Standard Event Status Enable Register in <nr1> numeric format. The syntax of the response is <nr1><rmt>.

*ESR? Returns the value in the Standard Event Status Register in <nr1> numeric format. The register is then cleared. The syntax of the response is <nr1><rmt>.

*IDN?	Returns the instrument identification. The exact response is determined by the instrument configuration and is of the form <NAME>, <model>, 0, <version><rmt> where <NAME> is the manufacturer's name, <MODEL> defines the type of instrument and <VERSION> is the revision level of the software installed.
*IST?	Returns <code>ist</code> local message as defined by IEEE Std. 488.2. The syntax of the response is 0<rmt>, if the local message is false or 1<rmt>, if the local message is true.
*OPC	Sets the Operation Complete bit (bit 0) in the Standard Event Status Register. This will happen immediately the command is executed because of the sequential nature of all operations.
*OPC?	Query operation complete status. The syntax of the response is 1<rmt>. The response will be available immediately the command is executed because of the sequential nature of all operations.
*PRE <nrf>	Set the Parallel Poll Enable Register to the value <nrf>.
*PRE?	Returns the value in the Parallel Poll Enable Register in <nr1> numeric format. The syntax of the response is <nr1><rmt>.
*SRE <nrf>	Set the Service Request Enable Register to <nrf>.
*SRE?	Returns the value of the Service Request Enable Register in <nr1> numeric format. The Syntax of the response is <nr1><rmt>.
*STB?	Returns the value of the Status Byte Register in <nr1> numeric format. The syntax of the response is <nr1><rmt>.
*WAI	Wait for operation complete true. As all commands are completely executed before the next is started this command takes no additional action.
*TST?	The generator has no self-test capability and the response is always 0<rmt>.
EER?	Query and clear execution error number register. The response format is nr1<rmt>.
QER?	Query and clear query the error number register. The response format is nr1<rmt>.

Miscellaneous Commands

*LRN?	Returns the complete set up of the instrument as a hexadecimal character data block. To re-install the set up the block should be returned to the instrument exactly as it is received. The syntax of the response is LRN <Character data><rmt>. The settings in the instrument are not affected by execution of the *LRN? command.
LRN <character data>	Install data for a previous *LRN? command.
*RST	Resets the instrument parameters to their default values (see Appendix).
*RCL <cpd>	Recalls the instrument set up contained in store <cpd>. There must be a memory card containing a set-up file named <cpd> in the instrument. Recalling store named "?" sets all parameters to the default settings (see Appendix).
*SAV <cpd>	Saves the complete instrument set up to the set-up file named <cpd>. There must be a memory card with space for the set-up file in the instrument.
*TRG	This command is the same as pressing the MAN TRIG key. Its effect will depend on the context in which it is asserted. The interface command Group Execute Trigger (GET) will perform the same action as *TRG.
COPYCHAN <nrf>	Copy the parameters from the current set-up channel to channel <nrf>.
HOLD <cpd>	Set hold mode <ON>, <OFF>, <ENAB> or <DISAB>. The ON or OFF forms are the same as pressing the MAN HOLD key. The ENAB and DISAB forms are channel specific and enable or disable the action of the MAN HOLD key or HOLD input.
FILTER <cpd>	Set the output filter to <AUTO>, <ELIP>, <BESS> or <NONE>.
SYSCLKFRQ <nrf>	Set the frequency of the system clock to <nrf> Hz
SYSCLKSRC <cpd>	Set the source of the system clock to <INT> or <EXT>.
BEEPMODE <cpd>	Set beep mode to <ON>, <OFF>, <WARN>, or <ERROR>.
BEEP	Sound one beep.

LOCAL	Returns the instrument to local operation and unlocks the keyboard. Will not function if LLO is in force.
UCBID?	Returns the instrument's address.

Refer to chapter 16, *Calibration*, for remote calibration commands.

Remote Command Summary

Table 17-1. Remote Command Summary

*CLS	Clear status.
*ESE <nrf>	Set the Standard Event Status Enable Register to the value of <nrf>.
*ESE?	Returns the value in the Standard Event Status Enable Register in <nr1> numeric format.
*ESR?	Returns the value in the Standard Event Status Register in <nr1> numeric format.
*IDN?	Returns the instrument identification.
*IST?	Returns ist local message as defined by IEEE Std. 488.2.
*LRN?	Returns the complete set up of the instrument as a hexadecimal character data block approximately 842 bytes long.
*OPC	Sets the Operation Complete bit (bit 0) in the Standard Event Status Register.
*OPC?	Query operation complete status.
*PRE <nrf>	Set the Parallel Poll Enable Register to the value <nrf>.
*PRE?	Returns the value in the Parallel Poll Enable Register in <nr1> numeric format.
*RCL <cpd>	Recalls the instrument set up contained in store <cpd>.
*RST	Resets the instrument parameters to their default values.
*SAV <cpd>	Saves the complete instrument set up to the set-up file named <cpd>.
*SRE <nrf>	Set the Service Request Enable Register to <nrf>.
*SRE?	Returns the value of the Service Request Enable Register in <nr1> numeric format.
*STB?	Returns the value of the Status Byte Register in <nr1> numeric format.
*TRG	This command is the same as pressing the MAN TRIG key.

*TST?	The generator has no self-test capability and the response is always 0<rmt>.
*WAI	Wait for operation complete true. executed before the next is started
ABORT	Aborts a phase locking operation.
AMDEPTH <nrf>	Set the depth for amplitude modulation to <nrf> %.
AMPL <nrf>	Set the amplitude to <nrf> in the units as specified by the AMPUNIT command.
AMPUNIT <cpd>	Set the amplitude units to <VPP>, <VRMS> or <DBM>.
ARB <cpd>	Select an arbitrary waveform for output.
ARBAMPL <cpd>,<nrf1>,<nrf2>,<nrf3>	Adjust the amplitude of arbitrary waveform <cpd> from start address <nrf1> to stop address <nrf2> by the factor <nrf3>.
ARBCOPY <cpd>,<nrf1>,<nrf2>,<nrf3>	Block copy in arbitrary waveform <cpd> the data from start address <nrf1> to stop address <nrf2> to destination address <nrf3>.
ARBCREATE <cpd>,<nrf>	Create a new, blank arbitrary waveform with name <cpd> and length <nrf> points.
ARBDATA <cpd>,<bin data block>	Load data to an existing arbitrary waveform.
ARBDATA? <cpd>	Returns the data from an existing arbitrary waveform.
ARBDATACSV <cpd>,<csv ascii data>	Load data to an existing arbitrary waveform.
ARBDATACSV? <cpd>	Returns the data from an existing arbitrary waveform.
ARBDEF <cpd>,<nrf>,<bin data block>	Define a new or existing arbitrary waveform with name <cpd> and length <nrf> and load with the data in <bin data block>.
ARBDEFCSV <cpd>,<nrf>,<csv ascii data>	Define a new or existing arbitrary waveform with name <cpd> and length <nrf> and load with the data in <csv ascii data>.
ARBDELETE <cpd>	Delete the arbitrary waveform <cpd> from memory card.
ARBEDLMTS <nrf1>,<nrf2>	Set the limits for the arbitrary waveform editing functions to start at <nrf1> and stop at <nrf2>.
ARBINSARB <cpd1>,<cpd2>,<nrf1>,<nrf2>	Insert the arbitrary waveform <cpd2> into arbitrary waveform <cpd1>. Use that part of <cpd2> specified by the ARBLIMITS command and insert from start address <nrf1> to stop address <nrf2>.

ARBINSSTD <cpd1>, <cpd2>, <nrf1>, <nrf2>	Insert the standard waveform <cpd2> into the arbitrary waveform <cpd1> from start address <nrf1> to stop address <nrf2>.
ARBINVERT <cpd>, <nrf1>, <nrf2>	Invert arbitrary waveform <cpd> between start address <nrf1> and stop address <nrf2>.
ARBLEN? <cpd>	Returns the length, in points, of the arbitrary waveform <cpd>.
ARBLINE <cpd>, <nrf1>, <nrf2>, <nrf3>, <nrf4>	Draw a line in arbitrary waveform <cpd> from start address/data <nrf1>/<nrf2> to stop address/data <nrf3>/<nrf4>.
ARBLIST?	Returns a list of all arbitrary waveforms on the memory card, each will return a name and length in the following form <cpd>, <nrf1>. The list will end with <rmt>.
ARBOFFSET <cpd>, <nrf1>, <nrf2>, <nrf3>	Move the data in arbitrary waveform <cpd> from start address <nrf1> to stop address <nrf2> by the offset <nrf3>.
ARBPOINT <cpd>, <nrf1>, <nrf2>	Set the waveform point at address <nrf1> in arbitrary waveform <cpd> to <nrf2>.
ARBRENAME <cpd1>, <cpd2>	Change the name of arbitrary waveform <cpd1> to <cpd2>.
ARBRESIZE <cpd>, <nrf>	Change the size of arbitrary waveform <cpd> to <nrf>.
BEEP	Set beep mode to <ON>, <OFF>, <WARN>, or <ERROR>.
BEEPMODE <cpd>	Sound one beep.
BSTCNT <nrf>	Set the burst count to <nrf>.
CF?	Returns available Compact Flash memory capacity (-1 for no card).
CFSIZE?	Returns the formatted capacity of the memory card in MBytes.
CFLABEL?	Returns the volume label of the memory card.
CLKFREQ <nrf>	Set the arbitrary sample clock freq to <nrf> Hz.
CLKPER <nrf>	Set the arbitrary sample clock period to <nrf> sec.
COPYCHAN <nrf>	Copy the parameters from the current setup chan to channel <nrf>.
DCOFFS <nrf>	Set the dc offset to <nrf> volts.
EER?	Query and clear execution error number register.
FILTER <cpd>	Set the output filter to <AUTO>, <ELIP>, <BESS> or <NONE>.

FORCETRIG	Force a trigger to the selected channel.
HOLD <cpd>	Set hold mode <ON>, <OFF>, <ENAB> or <DISAB>.
LOCKMODE <cpd>	Set the channel synchronization mode to <INDEP>, <MASTER>, <FTRACK> or <SLAVE>.
LOCKSTAT <cpd>	Set the channel synchronization status to <ON> or <OFF>.
LOCAL	Returns the instrument to local operation and unlocks the keyboard. Will not function if LLO is in force.
LRN <character data>	Install data for a previous *LRN? command.
MOD <cpd>	Set the modulation source to <OFF>, <EXT> or <PREV>.
MODE <cpd>	Set the mode to <CONT>, <GATE>, <TRIG>, <SWEEP> or <TONE>.
MODTYPE <cpd>	Set the modulation type to <AM> or <SCM>.
OUTPUT <cpd>	Set the main output <ON>, <OFF>, <NORMAL> or <INVERT>.
PHASE <nrf>	Set the slave generator phase to <nrf> degrees.
POSNMKRCLR <cpd>	Clear all position markers from arbitrary waveform <cpd>.
POSNMKRPAT <cpd1>, <nrf1> <nrf2>, <cpd2>	Put the pattern <cpd2> into the arbitrary waveform <cpd1> from start address <nrf1> to stop address <nrf2>.
POSNMKRRES <cpd>, <nrf>	Clear the position marker at address <nrf> in arbitrary waveform <cpd> to 0 (low).
POSNMKRSET <cpd>, <nrf>	Set the position marker at address <nrf> in arbitrary waveform <cpd> to 1 (high).
PULSDLY <nrf>	Set the pulse delay to <nrf> sec.
PULSPER <nrf>	Set the pulse period to <nrf> sec.
PULSWID <nrf>	Set the pulse width to <nrf> sec.
PULTRNBASE <nrf>	Set the pulse–train base line to <nrf> volts.
PULTRNDLY <nrf1>, <nrf2>	Set the delay of pulse–train pulse number <nrf1> to <nrf2> sec.
PULTRNLEN <nrf>	Set the number of pulses in the pulse–train to <nrf>.
PULTRNLEV <nrf1>, <nrf2>	Set the level of pulse–train pulse number <nrf1> to <nrf2> volts.
PULTRNMAKE	Makes the pulse–train and runs it – similar to the WAVE PULSTRN command.
PULTRNPER <nrf>	Set the pulse–train period to <nrf> sec.

PULTRNWID <nrf1>, <nrf2>	Set the width of pulse–train pulse number <nrf1> to <nrf2> sec.
QER?	Query and clear query error number register.
REFCLK <cpd>	Set the REF CLOCK IN/OUT to <IN>, <OUT>, <MASTER> or <SLAVE>.
SCMLEVEL <nrf>	Set the level for SCM to <nrf> Volts.
SETUPCH <nrf>	Select channel <nrf>
SEQCNT <nrf1>, <nrf2>	Set count for sequence segment <nrf1> to <nrf2>.
SEQSEG <nrf>, <cpd>	Set the status of sequence segment <nrf> to <ON> or <OFF>.
SEQSTEP <nrf>, <cpd>	Set the ‘step on’ parameter for sequence segment <nrf> to <COUNT>, <TRGEDGE> or <TRGLEV>.
SEQWFM <nrf>, <cpd>	Set the ‘waveform’ parameter for sequence segment <nrf> to <cpd>.
SUM <cpd>	Set the sum source to <OFF>, <EXT> or <PREV>.
SUMRATIO <nrf>	Set the sum ratio to <nrf>.
SWPCENTFRQ <nrf>	Set the sweep centre frequency to <nrf> Hz.
SWPDIRN <cpd>	Set the sweep direction to <UP>, <DOWN>, <DNUP> or <UPDN>.
SWPMKR <nrf>	Set the sweep marker to <nrf> Hz.
SWPSPACING <cpd>	Set the sweep spacing to <LIN> or <LOG>.
SWPSPAN <nrf>	Set the sweep frequency span to <nrf> Hz.
SWPSTARTFRQ <nrf>	Set the sweep start frequency to <nrf> Hz.
SWPSTOPFRQ <nrf>	Set the sweep stop frequency to <nrf> Hz.
SWPSYNC <cpd>	Set the sweep sync <ON> or <OFF>.
SWPTIME <nrf>	Set the sweep time to <nrf> sec.
SWPTYPE <cpd>	Set the sweep type to <CONT>, <TRIG> or <THLDRST> .
SYNCOUT <cpd>	Set the sync output <ON>, <OFF>, <AUTO>, <WFMSYNC>, <POSNMKR>, <BSTDONE>, <SEQSYNC>, <TRIGGER>, <SWPSYNC> or <PHASLOC>.
SYSCLKFRQ <nrf>	Set the frequency of the system clock to <nrf> Hz.
SYSCLKSRC <cpd>	Set the source of the system clock to <INT> or <EXT>.
ONEEND <nrf>	Delete tone frequency number <nrf> thus defining the end of the list.

TONEFREQ <nrf1>, <nrf2>, <nrf3>	Set tone frequency number <nrf1> to <nrf2> Hz. The third parameter sets the tone type; 1 will give trig, 2 will give FSK, any other value gives gate type.
TRIGIN <cpd>	Set the trig input to <INT>, <EXT>, <MAN>, <PREV>, <NEXT>, <POS> or <NEG>.
TRIGLEV <nrf>	Set the trigger threshold level to <nrf> volts.
TRIGOUT <cpd>	Set the trig output to <AUTO>, <WFMEND>, <POSNMKR>, <SEQSYNC> or <BSTDONE>.
TRIGPER <nrf>	Set the internal trigger generator period to <nrf> sec.
USBID?	Returns the instruments address.
VCAIN <cpd>	Set the vca/sum input to <VCA>, <SUM> or <OFF>.
WAVE <cpd>	Select the output waveform as <SINE>, <SQUARE>, <TRIANG>, <DC>, <POSRMP>, <NEGRMP>, <COSINE>, <HAVSIN>, <HAVCOS>, <SINC>, <PULSE>, <PULSTRN>, <NOISE> or <SEQ>.
WAVFREQ <nrf>	Set the waveform frequency to <nrf> Hz.
WAVPER <nrf>	Set the waveform period to <nrf> sec.
WFMCLKSRC <cpd>	Set the playback clock source of the selected waveform to <INT> or <EXT>.
ZLOAD <cpd>	Set the output load, which the generator is to assume for amplitude and dc offset entries, to <50> (50Ω), <600> (600Ω) or <OPEN>.

Chapter 18

Maintenance

Introduction..... 18-2
Cleaning 18-2

Introduction

The manufacturers or their agents overseas will provide a repair service for any unit developing a fault.

Where owners wish to undertake their own maintenance work, this should only be done by skilled personnel in conjunction with the service manual.

Cleaning

If the instrument requires cleaning use a cloth that is only lightly dampened with water or a mild detergent.



To avoid the possibility of electric shock or damage to the instrument, never allow water to get inside the case.



To avoid possible damage to the instrument, never use a solvent to clean it.

Appendices

Appendix	Title	Page
A	AC Supply Voltage	A-1
B	Warning and Error Messages	B-1
C	SYNC OUT Automatic Settings	C-1
D	Factory System Defaults	D-1
E	Waveform Manager Plus.....	E-1
F	Block Diagrams.....	F-1
G	Front and Rear Panel Drawings	G-1

Appendix A

AC Supply Voltage

Introduction

Before connecting the instrument to an ac outlet, check that the instrument operating voltage marked on the rear panel is correct for the local supply.



To avoid the possibility of electric shock, always ensure the instrument is disconnected from the ac supply before opening the case.

Changing the Supply Voltage Setting

If it is necessary to change the operating voltage, proceed as follows:

Single channel instrument model 291

1. Disconnect the instrument from all voltage sources.
2. Remove the screws which retain the top cover and lift off the cover.
3. Change the transformer connections following the diagram below.

To change the connection, cut the brown wire from the switch at the switch end of the crimped butt connector; make safe the exposed end of the connector.

Strip 6mm of insulation from the end of the cut brown wire; fit into the connector for the new supply voltage and crimp.

Check that the connection is mechanically secure and that there are no loose strands.

for **230V** operation connect the **brown** transformer wire to the brown wire from the switch

for **115V** operation connect the **red** transformer wire to the brown wire from the switch

for **100V** operation connect the **black** transformer wire to the brown wire from the switch

4. Refit the cover and the secure it with the screws.

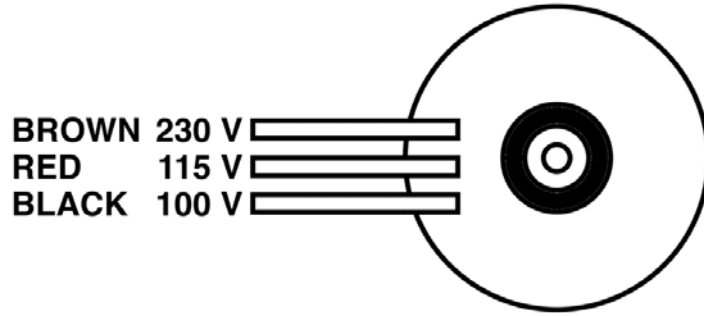

Figure 1-1. Mains transformer connections

shc0003f.gif

5. To comply with safety standard requirements the operating voltage marked on the rear panel must be changed to clearly show the new voltage setting.
6. Change the fuse to one of the correct rating; see below.

2- and 4-channel instruments models 292 and 294

These instruments have a universal input range and will operate from a nominal 100 V, 115 V or 230 V mains supply without adjustment. Check that the local supply meets the AC input requirement given in the specification.

Fuse

Ensure that the correct mains fuse is fitted for the set operating voltage. The correct mains fuse types are:

	230V operation:	100V or 115V operation:
single-channel instrument:	500 mA (T) 250 V HRC	1 A (T) 250 V HRC
2- and 4-channel instruments:	2 A (T) 250 V HRC	2 A (T) 250 V HRC

To replace the fuse, disconnect the mains lead from the inlet socket and withdraw the fuse drawer below the socket pins. Change the fuse and replace the drawer.

The use of makeshift fuses or short-circuiting of the fuse holder is prohibited.

Mains Lead

When a three core mains lead with bare ends is provided it should be connected as follows:

Brown	Mains Live
Blue	Mains Neutral
Green / Yellow	Mains Earth



To avoid the possibility of electric shock:

This instrument must be earthed.

Any interruption of the mains earth conductor inside or outside the instrument will make the instrument dangerous. Intentional interruption is prohibited. The protective action must not be negated by the use of an extension cord without a protective conductor.

Appendix B

Warning and Error Messages

Introduction

Warning messages are given when a setting may not give the expected result, e.g. dc offset attenuated by the output attenuator when a small amplitude is set; the setting is, however, implemented.

Error messages are given when an illegal setting is attempted; the previous setting is retained.

The last two warning or error messages can be reviewed by selecting `LAST ERROR` from the `UTILITY` screen. The latest is reported first.

Warning and error messages are reported with a number on the display; only the number is reported via the remote control interfaces.

The following is a complete list of messages as they appear on the display.

Warning Messages

- 00 No errors or warnings have been reported
- 13 DC offset changed by amplitude
- 14 Offset + Sum + level may cause clipping
- 16 Undoing unsaved amplitude or offset edit for <waveform name>
- 23 Offset will clip the waveform
- 24 Instrument not calibrated
- 26 Wrong channel count found <count1>, require <count2>. Issued when an attempt is made to recall a set-up file with a different channel count to that of the current instrument. The option is given to continue or cancel.
- 30 Amplitude will clip the waveform
- 42 Trigger source is fixed to external in SLAVE mode
- 59 Trigger slope is fixed to positive in SLAVE mode
- 81 The programmed mod depth cannot be set
- 83 Numeric value too large - switching to sample period

Error Messages

- 101 Frequency out of range for the selected waveform
- 102 Sample clock frequency required exceeds 100 MHz
- 103 Sample clock frequency required is less than 0.1 Hz
- 104 Pulse/pulse-train period out of range for current set-up
- 105 Pulse width cannot be greater than the period
- 106 Absolute value of pulse delay must be < period
- 107 Pulse width cannot be less than 10 ns
- 108 Maximum output level exceeded
- 109 Minimum output level exceeded
- 110 Minimum dc offset value exceeded
- 111 Maximum dc offset value exceeded
- 112 The value entered is out of range
- 115 There are no arb waveforms defined. Use WAVEFORM CREATE
- 117 Arb name exists, names must be unique
- 118 Arb waveform length exceeds available memory
- 119 Arb waveform length cannot be less than eight points
- 121 Start address error: must be in the range $0 \leq n \leq \text{stop addr}$
- 122 Stop address error: must be in the range $\text{start} \leq n \leq \text{waveform length}$
- 125 No GPIB available
- 126 File has no legal set-up for this instrument
- 127 System ram error battery fault or firmware updated
- 128 Point value error: must be in the range $-2048 \leq n \leq +2047$
- 129 Wave offset error: must be in the range $-4096 \leq n \leq +4095$
- 131 Wave amplitude error must be in the range $0 \leq n \leq 100$
- 132 Block dest error: must be in the range $0 \leq n \leq \text{waveform length}$
- 133 Sequence count value exceeds the maximum of 32,768
- 134 Sequence count value cannot be less than 1
- 135 Trigger generator maximum period is 200 s
- 136 Trigger generator minimum period is 10 μs
- 137 Waveform is not available with ext clock
- 138 Burst count value exceeds the maximum of 1,048,575
- 139 Burst count value cannot be less than 1
- 140 Trig/Gate freq too high. Max=2.5 MHz. Continuous mode set
- 141 Selected function is illegal in tone mode TONE MODE CANCELLED!
- 144 Selected combination of function and mode is illegal
- 145 Locked master/slave is available with continuous mode only
- 147 Current set-up requires an arb waveform which does not exist
- 148 Trig/gate mode and seq step value cause a trigger conflict
- 149 Seq step value can't mix edge and level between segments
- 150 Number of pulses in train must be between 1 and 10
- 151 Pulse train base level must be $>-5.0 \text{ V}$ and $<+5.0 \text{ V}$
- 152 Pulse level must be $>-5.0 \text{ V}$ and $<+5.0 \text{ V}$
- 153 Pulse number must be between 1 and 10
- 154 Sweep frequency values must be 1 mHz to 40 MHz
- 155 Sweep start freq must be less than stop freq
- 156 Sweep stop freq must be greater than start freq
- 157 Sweep time value is out of range $0.001 \text{ s} < n < 999 \text{ s}$
- 158 Sweep marker value is out of range $0.001 \text{ Hz} < n < 40 \text{ MHz}$
- 160 Not locked. This error indicates that a phase locking operation has failed.
- 161 Illegal phase value
- 178 Sum ratio is not possible within level constraints
- 179 Sum and internal modulation cannot be active together
- 180 Modulation depth or SCM level is out of range

- 182 Waveform is too long for the available channel memory
- 184 Sum or modulation conflict
- 186 Inter channel lock not possible. Lock status is off.
This error may occur for several reasons. In each case there is a conflict of the synchronization settings. In most cases the status of the synchronization is set to off. Any of the following conditions will cause this error:
 1. More than one master channel is enabled.
 2. No master channel is enabled.
 3. The locked channels contain a mixture of DDS and PLL generated waveforms.
 4. Frequency tracking is enabled (mode: master/freq) but the frequencies are not the same on all channels. If clock synthesized waveforms are locked the mode will be forced to frequency tracking.
 5. A synchronized channel is not set to continuous mode.
 6. An attempt is made to turn on synchronization with a frequency set too high.
 7. An attempt is made to set the frequency too high during synchronization. This error does not set synchronization to off, the system simply inhibits the setting of the incorrect frequency.
- 187 External clock independent channel is illegal with synchronization.
- 188 Maximum trigger level is +5.0 V
- 189 Minimum trigger level is -5.0 V
- 192 Unable to open memory card - try reinserting.
- 193 Memory card is wrong format or is not formatted
- 194 Memory card is full. Cannot create WAVES or SETUP directory
- 195 Sequence segment number out of range min 1, max 1024
- 196 System clock frequency out of range.
- 197 File <filename> not found load sts <waveform>
- 198 Memory card is full. Cannot create Set-up or Waveform file
- 199 Cannot format memory card. It must have 512 bytes per sector
- 200 Remove signal from external reference clock before editing reference clock

Remote Warnings

- 72 Length is different to that in the ARBDEF (CSV) command

Remote Errors

- 120 Waveform limit value out of range
- 126 Illegal store number requested
- 143 External clock not possible for current waveform
- 146 Remote command is illegal with external clock
- 162 Byte value outside the range 0 to 255
- 163 Specified arb name does not exist
- 164 Command illegal in sweep or tone mode
- 165 Cannot set waveform frequency or period for a sequence
- 166 Cannot set sample frequency or period for std waveforms
- 167 dBm output units assume a 50 Ohm termination
- 168 Specified units illegal for the selected waveform
- 169 Command not available for RS232
- 170 Length value error in binary block
- 171 Illegal value in arbitrary data
- 173 Illegal tone number
- 174 Illegal sequence segment number
- 175 Cannot insert arb into itself
- 176 Pattern value is illegal or pattern too long
- 177 Illegal remote calibration command.
- 185 Command not available while sweeping.

- 190 Memory card missing. Waveform <filename> not loaded
- 191 Set-up file <filename> not found. Loading defaults
OR
Waveform <filename> not found

Critical Stop Errors

These errors have no obvious recovery path and require user intervention. Some can be bypassed by a key press, some offer a choice of action. Possible hardware failures may be firmware induced and recover by cycling the power. Firmware errors all require a power cycle to recover.

Any of these errors may indicate an imminent system failure or a firmware bug.

- | | | |
|-----|--|---------------------------------|
| 201 | CRITICAL STOP! Fault in clock circuit of channel <chan>. | possible hardware failure |
| 202 | CRITICAL STOP! Fault in calibration flash memory block. | flash write fault |
| 203 | CRITICAL STOP! Memory card removed while active. | user error |
| 204 | CRITICAL STOP! Memory card file not found: <filename>. | possible unexpected card change |
| 205 | CRITICAL STOP! Stack Overflow. | firmware error |
| 206 | CRITICAL STOP! Stack Underflow. | firmware error |
| 207 | CRITICAL STOP! Illegal instruction. | firmware error |
| 208 | CRITICAL STOP! Illegal NMI. | firmware error |
| 209 | CRITICAL STOP! Heap overflow. | firmware error |

Appendix C

SYNC OUT Automatic Settings

Introduction

The following automatic source (src) settings are made when auto mode is selected on the SYNC OUT screen.

MODE	WAVEFORM	Waveform Sync	Position Marker	Burst Done	Sequence Sync	Trigger	Sweep Trigger	Phase Lock
Continuous	Standard	✓						
	Arbitrary	✓						
	Sequence				✓			
Gate/Trig	All					✓		
Sweep	All						✓	
Tone	All					✓		
Ext. Phase Lock Master	Sequence				✓			
	All others							✓

Appendix D

Factory System Defaults

Introduction

The factory system defaults are listed in full below. They can be recalled by pressing **RECALL** followed by set defaults or by the remote command *RST. All channels will receive the same set-up. All channels default to the same settings.

Main Parameters:

Std. wave:	Sine
Frequency:	10 kHz
Output:	+2.0 V p-p; output off
DC offset:	0 V
Zout:	HiZ

Gate/Trigger Parameters:

Source:	Internal
Period:	1 ms
Slope:	Positive
Burst count:	1
Phase	0 deg

Modulation Parameters:

Source:	Off
Type:	VCA

Sum:	Off
------	-----

Sweep Parameters:

Begin frequency: 100 kHz
End frequency: 40 MHz
Marker frequency: 10 MHz
Direction: Up
Spacing: Log
Sweep time: 10 ms
Type: Continuous

Filter Auto

Sync out Auto

Sequence all segments set as follows:

Status: Off except seg 1.
Wfm: None selected
Step on Count
Count: 1

Arbitrary All unaffected by reset or *RST.

Appendix E

Waveform Manager Plus

Waveform Manager Plus

Arbitrary Waveform Creation and Management Software

The Waveform Manager Plus program allows construction, editing, exchange, translation and storage of many types of waveform data. It is compatible with many popular DSOs and many waveform generation products.

Waveforms may be generated by equation entry, freehand drawing, combining existing waveforms or any combinations of these methods.

Data upload and download are possible via RS232 (COM1 to 4), USB or GPIB subject to a compatible GPIB card being correctly installed and configured in your PC.

Files can also be uploaded and downloaded to and from the memory card using the USB-connected card reader/writer supplied and the card then used directly with the instrument.

Both upload and download of waveform data are possible and, where applicable, data exchange via 3.5 in floppy disks in the Tektronix *.ISF format is available.

Text data may be read from the Windows clipboard and used to create a waveform. The text data format is very free and will allow most lists of numbers, with or without intervening text, to be read as waveform data points. Waveform data may also be pasted to the clipboard for insertion into other programs.

Waveforms are displayed in fully scaleable windows and may be manipulated graphically. Any number of waveforms in any of the supported types may be displayed simultaneously.

On-line help is available in three ways.

1. The help menu contains a contents option from which you can go to any section of the on-line help file or browse particular areas or the whole file. It is also possible to use the Index and Find operations of the Windows help system to search for items which are not listed directly in the contents section.

2. Some dialog boxes have a Help button which, when clicked, will open the on-line help file at the section containing the description of that dialog box.
3. From most windows and dialogues the F1 key will open the help file at the relevant section.

Waveform Manager allows you to keep waveforms for different projects separate from each other on your hard drive. A project may be placed anywhere, in any directory (folder) and all waveform files for that project will be stored in a structure below that directory. A project is identified by a user defined name. Each project maintains its own library of expressions.

Appendix F Block Diagrams

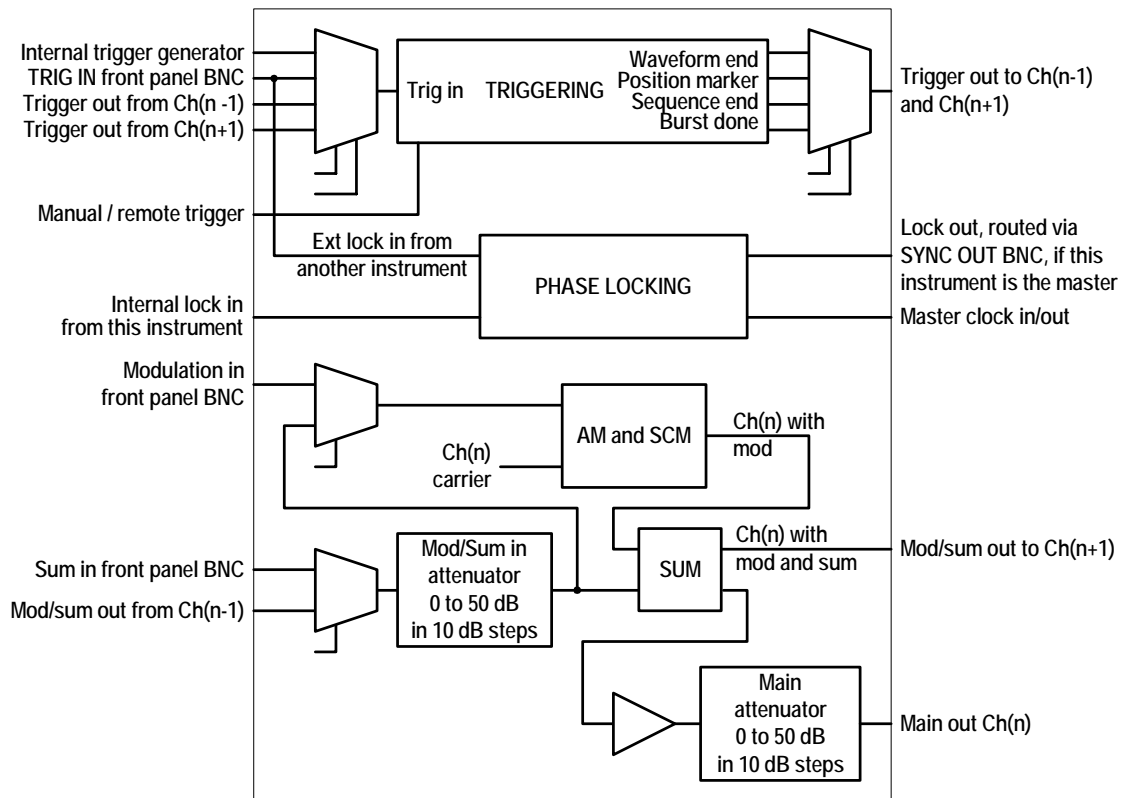

shc0008f.emf

Figure F-1. Block Diagram: Single Channel

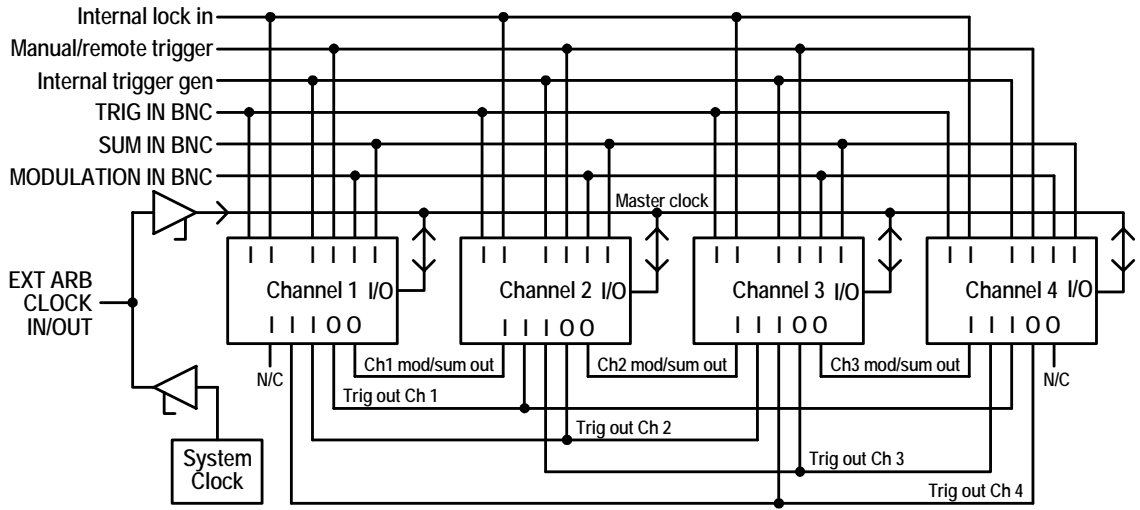

Figure F-2. Inter-Channel Block Diagram

shc0009f.emf

Appendix G

Front and Rear Panel Drawings

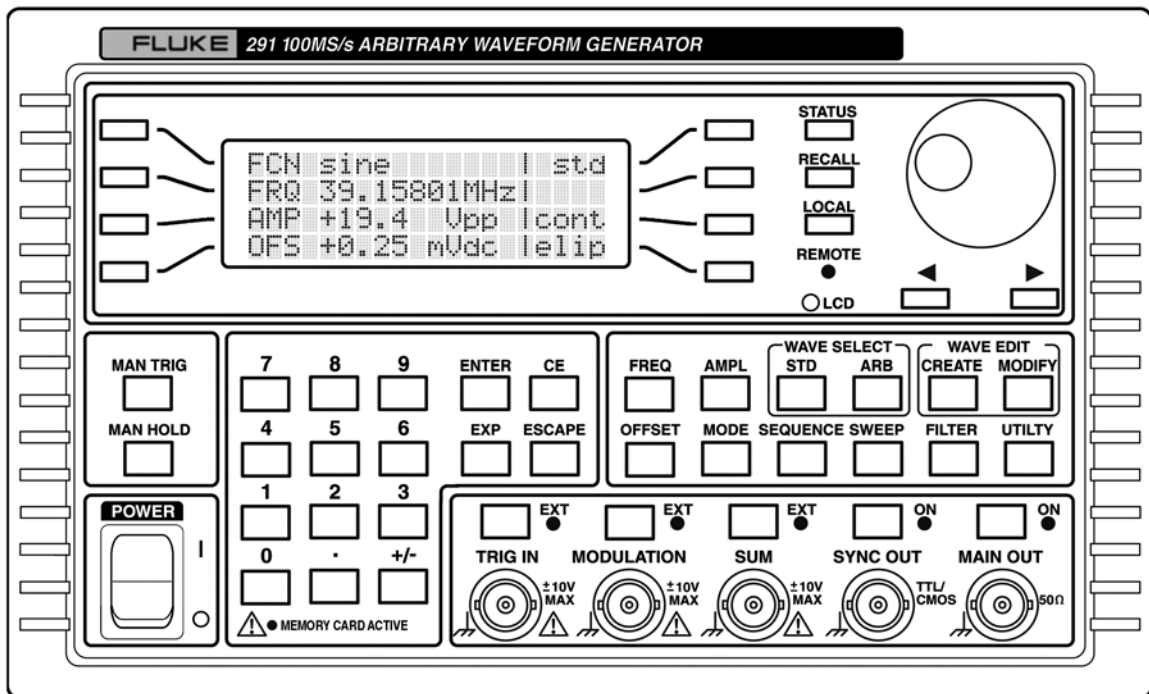

Figure G-1. Model 291 Front Panel

shc0014f.gif

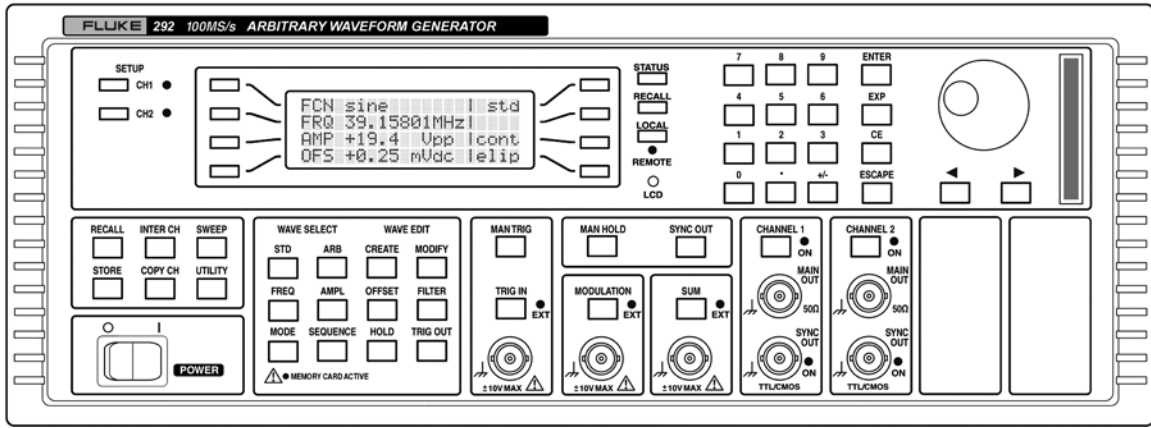

Figure G-2. Model 292 Front Panel

shc0015f.gif

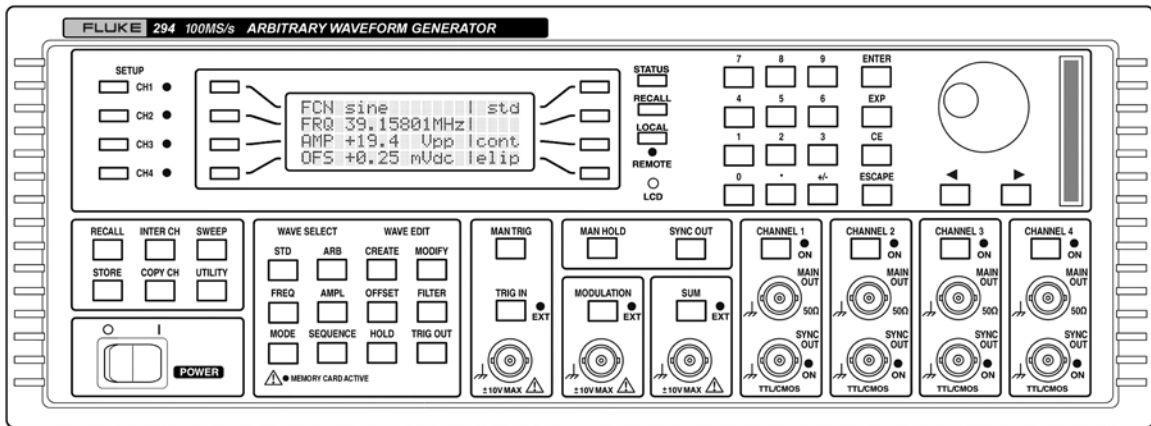

Figure G-3. Model 294 Front Panel

shc0016f.gif

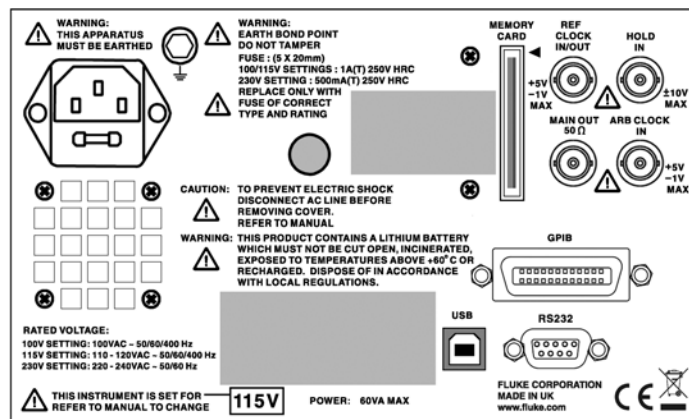
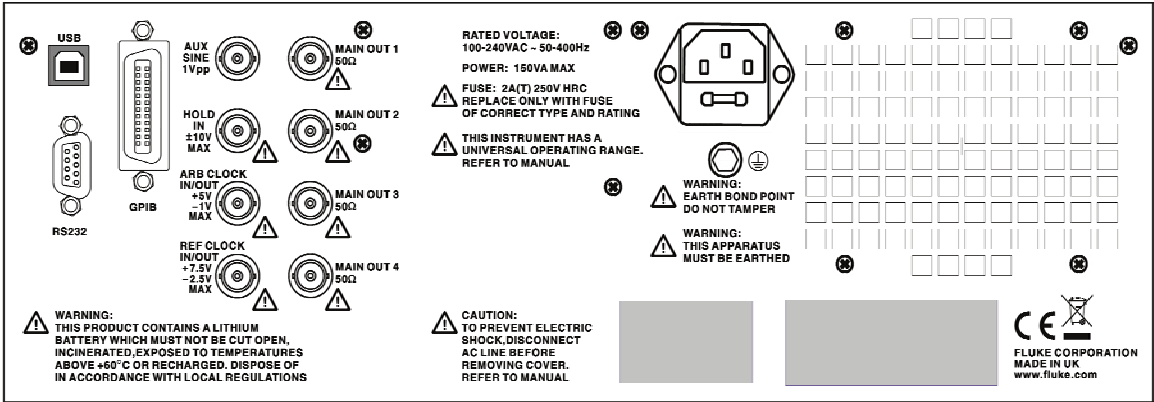

Figure G-4. Model 291 Rear Panel

shc0017f.gif



shc0018f.gif

Figure G-5. Model 294 Rear Panel

Index

—A—

- AC supply, 2-2
- adding waveforms, 12-2
- address, remote, 17-2
- addressable RS232, 17-3, 17-4
- adjacent channel trigger, 7-3
- amplitude modulation, 1-9
- arb clock in, 1-9, 3-4
- arb clock out, 1-9
- arb waveforms, 9-2
 - amplitude, 9-9, 9-15
 - block copy, 9-8
 - copying, 9-4, 9-8
 - creating, 9-4
 - editing, 9-7
 - external clock, 9-13
 - frequency, 9-13
 - hold, 9-15
 - information, 9-6
 - insert wave, 9-8
 - inversion, 9-10
 - markers, 9-10
 - modifying, 9-5
 - offset, 9-10
 - principles, 9-2
 - renaming, 9-6
 - selecting, 9-3
 - sequence, 9-11
 - sync out, 9-15
 - terms used, 9-2
 - wave insert, 9-8
- attenuator, 5-4
- auxiliary sine out, 1-8

—B—

- Baud rate selection, 17-2
- beep, 5-6, 15-2

burst

- count, 7-4
- done, 3-2, 5-6
- mode, 7-3
- start phase, 7-5

—C—

- calibration, 16-2
 - remote, 16-6
- card reader, 14-2
- character set
 - RS232, 17-4
- cleaning, 18-2
- clipping, 12-2
- clock synthesis, 4-5
- clock, external, 9-13, 10-3
- command list, 17-11
- commands
 - amplitude, 17-12
 - arb create/delete, 17-13
 - arb edit, 17-15
 - channel selection, 17-12
 - dc offset, 17-12
 - frequency, 17-12
 - input/output, 17-18
 - miscellaneous, 17-21
 - mode, 17-18
 - modulation, 17-19
 - period, 17-12
 - remote, 17-10
 - sequence, 17-17
 - status, 17-19
 - summary, 17-22
 - synchronizing, 17-19
 - waveform selection, 17-13
- compact flash, 14-2
- connections
 - sweep, 6-2
 - synchronization, 13-6

connector
 GPIB, 17-6
 RS232, 17-3
 USB, 17-6
copy channel, 15-4

—D—

daisy chain, 1-11, 17-3
data entry, 4-3
dc offset
 attenuation, 5-4
DDS mode, 4-6
delays
 hardware, 13-7
direct digital synthesis, 4-5, 4-6
display, 4-2
DTMF, 1-7, 8-3, 12-2
dual tone multi-frequency, 1-7

—E—

editing
 principles of, 4-3
error messages, 5-5, 15-2
external clock, 9-13, 10-3, 10-7
external trigger, 7-2

—F—

features, 1-2
filter, 1-5, 9-16
flash card reader, 14-2
forced trigger, 7-5
formatting memory card, 14-3
frequency
 sequence, 9-14
frequency shift keying, 8-3
frequency synchronizing, 13-2
fuse, 2-2

—G—

gate
 polarity, 7-6
 source, 7-6
gated mode, 1-6
GPIB, 1-11, 3-5
 error handling, 17-7
 interface, 17-6
 parallel poll, 17-7
 remote commands, 17-11
 status reporting, 17-8

—H—

hold, 10-8
 arb waveforms, 9-15
 manual, 10-8
hold in, 1-9, 3-3

—I—

IEEE-488, 1-11, 3-5
initial operation, 4-2
input
 arb clock, 1-9, 3-4
 hold, 1-9, 3-3
 modulation, 1-8, 3-3
 ref clock, 1-9, 3-3
 sum, 1-9, 3-3, 12-2
 trig, 3-3
 trigger, 1-8
inputs, 1-8
inter-channel
 modulation, 1-9
 operation, 1-9
 sum, 1-10
 synchronization, 1-10
 triggering, 1-10
interface
 GPIB, 17-6
 remote, 1-11
 USB, 17-6
internal trigger generator, 1-7, 7-2

—K—

key
 ampl, 4-3, 5-3
 copy ch, 4-3, 15-4
 data entry, 4-3
 filter, 9-16
 freq, 4-3, 5-2
 inter ch, 4-3
 local, 17-2
 man hold, 4-3, 10-8
 man trig, 4-3
 mode, 4-3
 modulation, 4-3
 numeric, 4-3
 offset, 4-3, 5-4
 sequence, 4-3
 setup, 4-2, 4-3
 soft, 4-3
 status, 4-2, 4-3
 std, 5-2
 sum, 4-3
 sweep, 4-3
 sync out, 4-3, 5-6
 trig in, 4-3, 7-2
 utility, 4-3, 14-2, 15-2
 wave edit, 4-2
 wave select, 4-2

—M—

main out, 3-2
 rear panel, 3-4
maintenance, 18-2

manual hold, 10-8
 marker patterns, 9-11
 master-slave, 13-2
 memory card, 9-3
 directories, 14-2
 format, 14-2
 formatting, 14-3
 saving files, 14-3
 slot, 3-5
 sorting files, 14-5
 menu
 utility, 15-2
 message
 reviewing, 5-6
 settings, 5-6
 messages
 errors and warnings, 5-5, 15-2
 remote, B-3
 mode
 clock synthesis, 4-5
 DDS, 4-6
 gated, 1-6, 7-6
 pulse, 10-2
 sweep, 1-6
 tone, 8-2
 tone switching, 1-7
 triggered burst, 1-6
 modes
 of operation, 1-6
 modulation
 internal, 11-3
 SCM, 11-3
 VCA, 11-2
 modulation in, 1-8, 3-3
 mounting, 2-2

—N—

noise, 1-5

—O—

operation
 principles of, 4-5
 output
 arb clock, 1-9
 output
 arb clock, 3-4
 main, 1-7
 ref clock, 1-9, 3-3
 sync, 1-8
 output filter, 9-16
 output impedance, 1-7
 outputs, 1-7
 main, 3-2
 sync, 3-2, 5-6

—P—

password
 calibration, 16-3
 phase lock, 3-2, 5-6
 phase locking, 13-4
 phase resolution, 7-5, 7-7
 position marker, 3-2, 5-6, 9-10
 power-on setting, 15-3, 17-10
 power-up, 4-2
 pulse
 delay, 10-2
 period, 10-2
 width, 10-2
 pulse train, 10-4
 baseline, 10-5
 delay, 10-6
 level, 10-6
 period, 10-6
 width, 10-6

—R—

rear panel main out, 3-4
 ref clock in/out, 1-9, 3-3
 remote command summary, 17-22
 remote/local operation, 17-2
 repair service, 18-2
 resolution
 pulse, 10-3
 RS232, 1-11, 17-3
 connector, 3-4
 remote commands, 17-10

—S—

screen
 AMPLITUDE, 5-3, 9-15
 ARB HOLD, 9-15
 CALIBRATION, 16-2
 DC OFFSET, 5-4
 ERROR SETTINGS, 15-2
 FILTER, 9-16
 REMOTE, 17-2
 STANDARD FREQUENCY, 5-2
 STANDARD WAVEFORMS, 5-2
 SUM, 12-2
 SYNC OUT, 5-6
 TRIGGER OUT, 7-3
 sequence, 1-5, 9-11
 frequency, 9-14
 sync, 3-2, 5-6
 settings
 automatic sync, C-1
 errors and warnings, 15-2
 power-on, 17-2, 17-10
 soft-keys, 4-3
 specifications, 1-4
 start phase, 7-5, 7-6

- status model, 17-9
- step on criterion, 9-12
- sum, 12-2
- sum in, 1-9, 3-3
- supply cable, 2-2
- supply voltage, 2-2
- suppressed carrier modulation, 1-9
- sweep
 - connections, 6-2
 - duration, 6-4
 - marker, 6-5
 - mode, 1-6
 - principles, 6-2
 - spacing, 6-5
 - span, 6-3
 - sync, 3-2, 5-6
 - time, 6-3
 - type, 6-4
- sync out, 3-2
 - arb waveforms, 9-15
- sync out key, 5-6
- synchronization, 1-10, 13-2
 - between instruments, 13-5
 - connections:, 13-6
 - within instruments, 13-2
- synchronize, 13-3
- SYS/REF Clock, 15-2
- system clock, 1-8
- System Clock Setting, 15-2
- system information, 15-3

—T—

- tone
 - mode, 8-2
 - switching source, 8-3
 - type, 8-2
- tone switching mode, 1-7
- trig in, 3-3
- trigger, 3-2, 5-6
 - adjacent channel, 7-3
 - edge, 7-4
 - external, 7-2
 - force, 7-5
 - generator, 1-7, 7-2
 - in, 1-8
 - slope, 7-4
- triggered burst mode, 1-6, 7-3
- triggering
 - inter-channel, 1-10

—U—

- USB connector, 3-5
- USB interface, 17-6

—V—

- ventilation, 2-2

—W—

- warning messages, 5-5, 15-2
- waveform
 - arbitrary, 1-5
 - cosine, 1-4
 - havercosine, 1-4
 - haversine, 1-4
 - information, 15-2
 - noise, 1-5
 - phase, 13-4
 - pulse, 1-5
 - pulse-train, 1-5
 - ramp, 1-4
 - sequence, 1-5
 - sin(x)/x, 1-4
 - sine, 1-4
 - square, 1-4
 - standard, 1-4
 - sum, 12-2
 - triangle, 1-4
- waveform hold, 10-8
- waveform sync, 3-2, 5-6