

USER MANUAL

DIGITAL REFRIGERANTS MANIFOLDS

Si-RM350 / Si-RM450

Find Quality Products Online at:

www.GlobalTestSupply.com

sales@GlobalTestSupply.com

Table of contents

1. Safety instructions	5
1.1 General warnings about the device	5
1.2 Warnings about the manifolds	5
1.3 Environment protection	6
1.4 Symbols used	6
2. Conformity and standard	7
2.1 FCC rules	7
2.2 Canadian standard	7
3. Introduction	8
3.1 Description of the device	8
3.1.1 Si-RM350 Overall description.....	8
3.1.2 Si-RM450 Overall description.....	8
3.1.3 Screen description	9
3.2 Connections description	9
3.3 Keys description	10
4. Features	11
4.1 General features.....	11
4.2 Features of the housing	11
4.3 Dimensions	11
4.4 Parameters features.....	12
4.4.1 Pressure	12
4.4.2 Temperature	12
4.5 List of refrigerant gases	13
4.6 Gliding refrigerants.....	14
5. Start with the manifold	15
5.1 Power supply.....	15
5.2 First start-up	15
6. Connect a probe and the scale	16
6.1 Wired probe	16
6.2 Wireless probe.....	16
6.2.1 Scan a probe	16
6.2.2 Information about probes	17
6.3 Scale.....	17
6.3.1 Scan the scale	17
6.3.2 Information about the scale	18
7. Set the device	19
7.1 Set the language	19
7.2 Set the date format	19
7.3 Set the time format	19
7.4 Set the timezone	19
7.5 Set the autopower off.....	19
7.6 Set the backlight	19
7.7 Select the display mode	20
8. Set the measurement parameters	21
8.1 Set the units.....	21
8.2 Set the temperature compensation	21
8.3 Set the pressure type	21
8.4 Set the atmospheric pressure	21
9. Perform a refrigeration test	22
10. Evacuation function	24
11. Perform a pressure test	25

12. Filling / Recovery function	26
12.1 Filling mode	26
12.2 Recovery mode.....	28
13. Perform a refrigeration one-way test	30
14. Calculate the target superheat	32
15. Perform a delta T measurement	33
16. Perform a compressor test.....	34
17. Calculate the efficiency of the installation	35
17.1 Coefficient of performance	35
17.2 Energy Efficiency Ratio.....	35
18. Data recording	36
18.1 Set data recording features.....	36
18.1.1 Select measure to save	36
18.1.2 Set the measurement interval	36
18.1.3 Set the recording duration	36
18.2 Launch the data recording	36
18.3 Erase data stored in the manifold	37
19. Device information.....	38
19.1 Information about memory	38
19.1.1 Erase memory.....	38
19.2 Reset instrument from factory settings	38
20. Maintenance and precautions for use	40
20.1 Maintenance	40
20.2 Cleaning	40
20.3 Precautions for use.....	40
21. Overview of the manifold range.....	41
21.1 Overview.....	41
21.2 Accessories.....	41

1. Safety instructions

Before using the device, please read carefully this user manual. It delivers important information about the device operations, maintenance and storage.

1.1 General warnings about the device

- Interior and exterior use.
- Respect the measuring ranges of the probes and hoses connected to the device.
- This device has been developed and produced to be sold exclusively to trained and qualified HVACR technicians and engineers. Appropriate training might be necessary in order to ensure safe use of this instrument. Sauermann is not responsible for any possible accident during its use.
- Please always use the device in accordance with its intended use and within parameters described in the technical features in order not to compromise the protection ensured by the device.
- When using the device, the safety of the system integrating the device is the responsibility of the system assembler.
- This device can pose a risk for pacemaker wearers. Respect a distance of at least 10 cm (4") between the device and the wearer.
- Respect a safety distance with other electronic devices like computers, credit cards or TV screens which could be damaged by the magnetic field of the device.
- Only the accessories provided with the device or available as an option must be used.
- Do not use the device if it is damaged or if it operates abnormally. Inspect the device before every use. In case of doubt, please contact Sauermann's After-sales service.
- In case of contact with battery/accumulator fluid: Rinse the affected areas thoroughly with water and, if necessary, consult a doctor.
- Do not authorize pressures beyond the device limits. Please refer to the technical features described in this user manual.
- The device must not be exposed to rain or any other humid environments (> 85 %RH) without using a proper protection.
- Do not use the device next to explosive and corrosives gases, vapours or dust.
- Do not place your fingers in movable zones of the device (articulations).
- The device must not be used in ATEX zones according to applicable standards.
- Do not store the device with solvents. Do not use desiccants. Do not use isopropanol.
- During use, keep inspecting the device and accessories for effective operation and your own safety.
- Do not give this product to a child.
- If the device falls or in case of similar inconveniences, or if an irregular malfunction appears, please send back the device to Sauermann's After-sales service for a technical check and to ensure your own safety.

1.2 Warnings about the manifolds

- A1 / A2L / A2 / A3 refrigerants compatible.
- Compatible with some B1 refrigerants, see list of refrigerants for details on which refrigerants are compatible. The device must not be used with ammoniac refrigerant (NH₃ / R717).
- During maintenance and repair work on refrigeration systems with flammable refrigerants (e.g. category A2L, A2 and A3 of ISO 817), a hazardous atmosphere must always be expected in the immediate vicinity of the system. This product may only be operated outside the hazardous zone.
- The manifold should be used in a well ventilated area.
- Respect the pressure measuring range (-1 to 60 bar / -14 to 870 psi), especially for systems with refrigerant R744, as these are often operated at higher pressures.
- Maximum overload pressure: 65 bar (943 psi).
- Open and close valves on the manifold in the correct sequence to avoid any leakage of refrigerant from the system throughout the commissioning, maintenance and repair period.
- This device has been developed to measure simultaneous parameters including pressure, vacuum and temperature measurements. It must not be used in any other purpose.
- Always use the hook to attach the manifold to prevent it from falling (risk of breakage) before applying pressure.
- Before each measurement, check that the refrigerant hoses are intact and correctly connected. Do not use any tools to connect the hoses, only hand-tighten the hoses.
- The user must avoid electrostatic charging by being grounded.
- The user of the manifold shall be protected against electrostatic discharges and discharge from static electricity from its body by being in contact with grounded metallic object or by using an anti-ESD equipment.
- Always wear protective glasses and gloves when using the device in order to protect your eyes and skin when operating with refrigerant gases. The vapours of refrigerant gases are extremely cold. Do not expose your skin to these vapours.



1.3 Environment protection

Send back the device at its end of working life for waste collection center of electrical and electronic components (according to local regulations), or send it back to Sauermann to ensure a required waste collection in the respect of the environment.

Refrigerant gases can harm the environment. Please comply with current legislation on refrigerant gases about environment protection.

1.4 Symbols used

For your safety and in order to avoid any damage of the device, please follow the procedure described in this user manual and read carefully the notes preceded by the following symbol:



The following symbol will also be used in this user manual:
Please read carefully the information notes indicated after this symbol.

2. Conformity and standard

The manifold complies with 2015/863 EU (RoHS 3). Document available on request.

Hereby, Sauermann Industrie SAS declares that the radio equipment types Si-RM350 and Si-RM450 is in compliance with Directive 2014/53/EU. The full text of the EU declaration of conformity is available at the following internet address: sauermanngroup.com.

2.1 FCC rules

This equipment has been tested and found to comply with the limits for a Class B digital device, pursuant to part 15 of the FCC Rules. These limits are designed to provide reasonable protection against harmful interference in a residential installation. This equipment generates, uses and can radiate radio frequency energy and, if not installed and used in accordance with the instructions, may cause harmful interference to radio communications. However, there is no guarantee that interference will not occur in a particular installation. If this equipment does cause harmful interference to radio or television reception, which can be determined by turning the equipment off and on, the user is encouraged to try to correct the interference's by one or more of the following measures:

- Reorient or relocate the receiving antenna.
- Increase the separation between the equipment and receiver.
- Connect the equipment into an outlet on a circuit different from that to which the receiver is connected
- Consult the dealer or an experienced radio/TV technician for help.

Changes or modifications not expressly approved by Sauermann could voice the user's authority to operate the equipment.

This device complies with part 15 of the FCC Rules.

Operation is subject to the following two conditions:

1. This device may not cause interference, and
2. This device must accept any interference received, including interference that may cause undesired operation.

2.2 Canadian standard

This device contains licence-exempt transmitter(s)/receiver(s) that comply with innovation, Science and Economic Development Canada's licence-exempt RSS(s). Operation is subject to the following two conditions:

1. This device may not cause interference.
2. This device must accept any interference, including interference that may cause undesired operation of the device.

3. Introduction

3.1 Description of the device

3.1.1 Si-RM350 Overall description

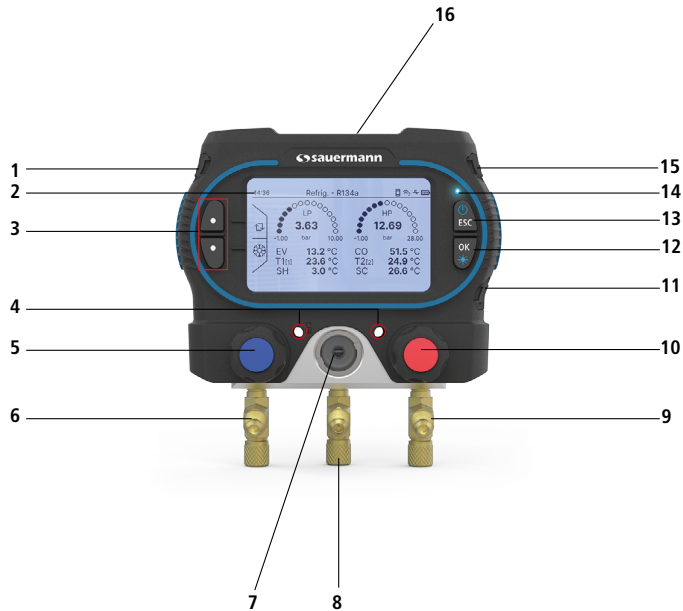

- 01. T1 port / Suction Line temperature (SLT) port
- 02. Screen
- 03. Selection buttons
- 04. Anti-theft device slot
- 05. Low pressure valve
- 06. Y connector 1/8 NPT 1/4 SAE
- 07. Sight glass for refrigerant flow
- 08. Y connector 1/8 NPT 1/4 SAE with Schrader® valve
- 09. Y connector 1/8 NPT 1/4 SAE
- 10. High pressure valve
- 11. USB-C port
- 12. OK/Backlight button
- 13. On/Off/Esc button
- 14. LED
- 15. T2 port / Liquid Line temperature (LLT) port
- 16. Fixing hook

3.1.2 Si-RM450 Overall description

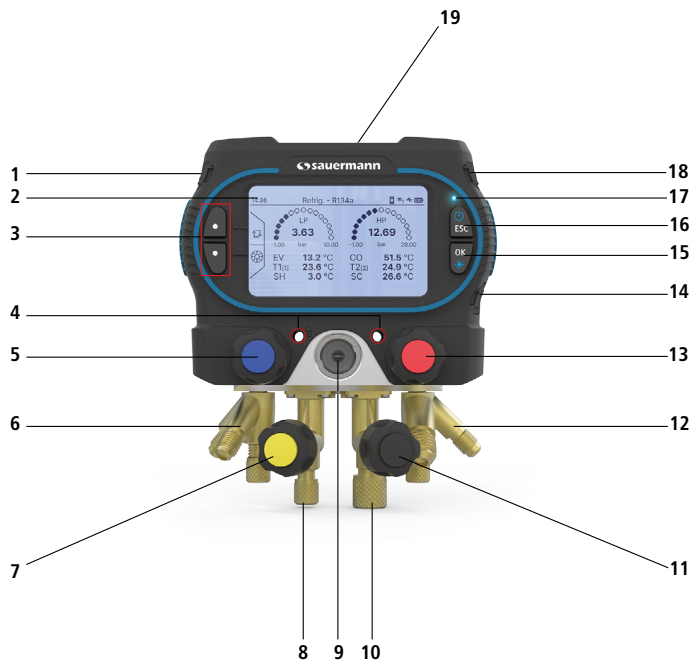

- 01. T1 port / Suction Line temperature (SLT) port
- 02. Screen
- 03. Selection buttons
- 04. Anti-theft device slot
- 05. Low pressure valve
- 06. Pressure hose connector 1/4 SAE
- 07. Refrigerant valve
- 08. Hose connector 1/4 SAE
- 09. Sight glass for refrigerant flow
- 10. Hose connector 3/8 SAE
- 11. Vacuum valve
- 12. Pressure hose support 1/4 SAE
- 13. High pressure valve
- 14. USB-C port
- 15. OK/Backlight button
- 16. On/Off/Esc button
- 17. LED
- 18. T2 port / Liquid Line temperature (LLT) port
- 19. Fixing hook

3.1.3 Screen description

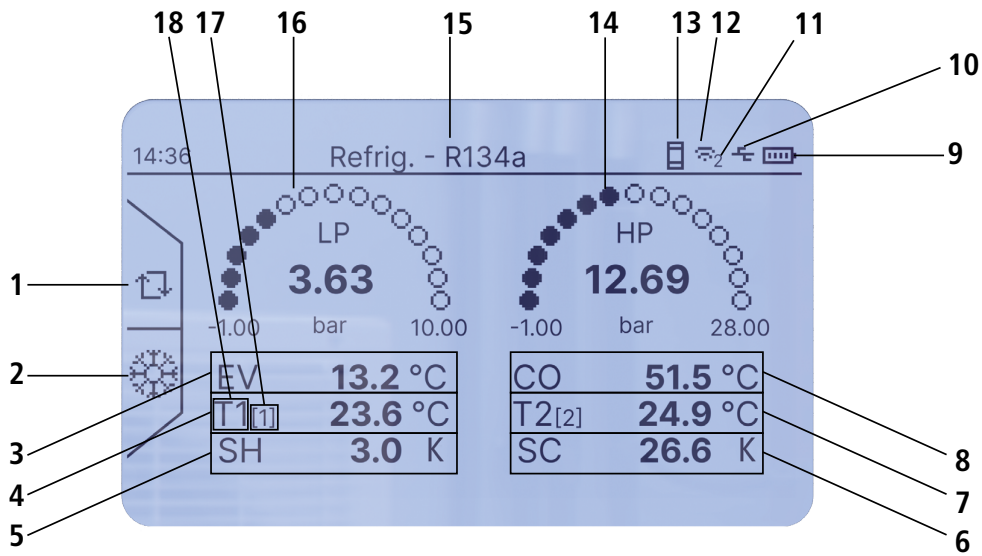





- | | |
|-----------------------------|---------------------------------------------------|
| 01. Autozero | 10. USB connection |
| 02. Refrigerant selection | 11. Number of connected wireless probes |
| 03. Evaporator temperature | 12. Wireless communication |
| 04. T1 Temperature | 13. Smartphone connection |
| 05. Superheat temperature | 14. High pressure measured |
| 06. Subcooling temperature | 15. Current refrigerant used |
| 07. T2 temperature | 16. Low pressure measured |
| 08. Condensator temperature | 17. Last 3 digits of the wireless connected probe |
| 09. Battery level | 18. Probe assignment |

3.2 Connections description



- (1) Port for wired temperature probe T1
- (2) Port for wired temperature probe T2
- (3) USB-C port as alternative power source to batteries

3.3 Keys description

	Navigation key. Can also be used to access other manifold functions (autozero, stop, alarm config)
	Navigation key. Can also be used to access other manifold functions (refrigerant list, start)
	Long press (3 seconds): Switch On/Off the manifold. Short press: Back to previous menu.
	Short press: Validate selection. Long press (3 seconds): On/Off backlight.

4. Features

4.1 General features

Power supply	4 × LR6 or AA 1.5 V batteries. Alternative power supply: USB-C
Battery life	300 hours*
Memory	Up to 600 000 points and 9 days of recording
Display	Graphic screen; 240 x 128 px
Languages	English UK (United Kingdom), English US (United States), French, Spanish, Italian, German, Chinese, Portuguese, Romanian, Hungarian, Polish, Dutch
Pressure connectors	Si-RM350: 3x 1/4 MFL male Si-RM450: 3x 1/4 MFL male + 1x 3/8 MFL male
Temperature connectors	2x wired jack (NTC)
Wireless frequency	Range frequency from 2402 MHz to 2480 MHz with a transmission power of 8 dBm.
Wireless range	Range between manifold and wireless probes up to 100 m (328 ft). App connection: depends on smartphone radio strength, range up to 100 m (328 ft).
Compatibility	Smartphone minimum required versions: Android 11.0, iOS 15, BLE 5.0**
Port	USB-C
Superheat and subcooling	Automatically calculated by the device
Environmental conditions of use	In non-condensing condition Altitude: from 0 to 2000 m (0 to 6561 ft) Non-corrosive gases
Operating temperature	From -20 to 50°C (-4 to 122°F)
Storage temperature	-20 to 50°C (-4 to 122°F)
European directives	2014/53/EU (RED) - 2015/863 EU (RoHS 3) - 2012/19/EU WEEE

*At 20°C without backlight and wireless communication. ** Can work with BLE4.0 but the wireless range will be downgraded

4.2 Features of the housing

Control	4 keys (Up / Down / OK / Esc)
Hook	High strength aluminum
Material	Plastic parts in polyamide reinforced with 30% of glass fiber (PA 6.6 + 30 GF)
Protection	IP54, suitable for A2L and A3 refrigerants
Weight	Si-RM350: 0.980 Kg (2.16 lb) Si-RM450: 1.330 Kg (2.93 lb)

4.3 Dimensions

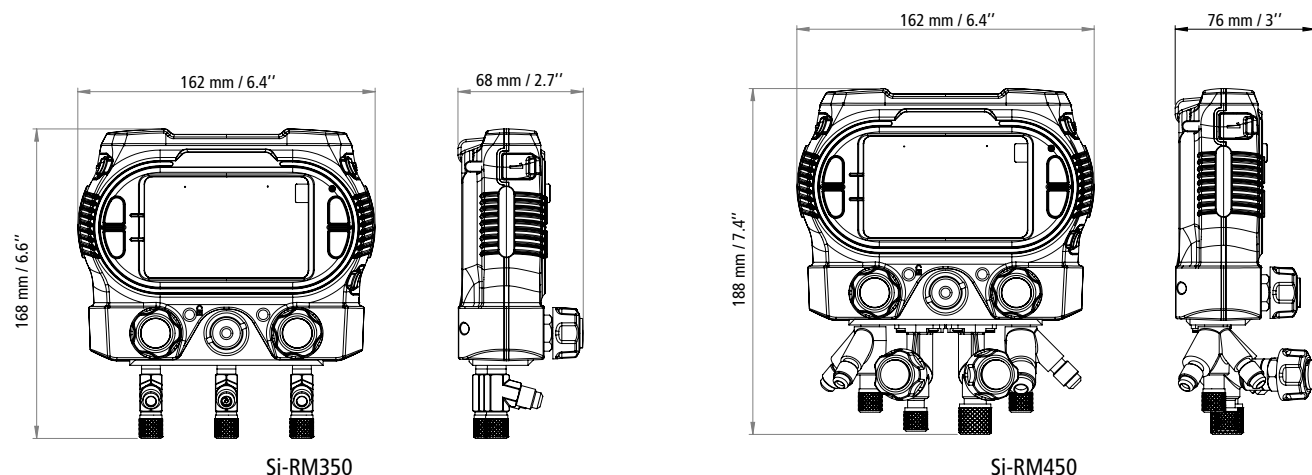

4.4 Parameters features

4.4.1 Pressure

Pressure is measured by flexible hoses connected to the Si-RM350 or the Si-RM450.

Pressure valves	3 valves (Si-RM350) / 4 valves (Si-RM450)
Measuring range	From -1 to 60 bar (-14 to 870 psi)
Pressure sensing accuracy*	±0.50% of full scale
Available units	bar, psi, kPa, MPa
Resolution	0.01 bar / 0.1 psi / 1 kPa / 0.001 MPa
Overload	65 bar (943 psi)
Burst pressure	150 bar (2175 psi)
Max pressure hose	55 bar (800 psi)

4.4.2 Temperature

Pipe temperature can be measured by wired temperature clamp (Si-RT2), wireless temperature clamp (Si-RT7) or wired self-gripping probe (Si-RT5).

- **Si-RT2 probe**

Temperature sensors	NTC
Temperature sensor range	-50 to 120°C (-58 to 248°F)
Temperature accuracy*	From -20 to 85°C (-4 to 185°F): ±1°C (±1.8°F)
Maximum operating temperatures	Jaws: 150°C (302°F) - Handle: 90°C (194°F)
Available units	°C, °F
Resolution	0.1°C, 0.1°F
Pipes diameter	6 to 42 mm (0.2" to 1.7")
Cable	2 m (6 ft) length with strengthened 3-point jack connector, Ø3.2 mm, in PVC, max. temperature 105°C (221°F)
Storage temperature	From -20 to 50°C (-4 to 122°F)

- **Si-RT5 probe**

Temperature sensors	NTC
Temperature sensor range	-20 to 85°C (-4 to 185°F)
Temperature accuracy*	-20°C to 70°C (-4 to 158°F): ±0.3°C (±0.6°F) 70°C to 85°C (158 to 185°F): ±0.5°C (±0.9°F)
Available units	°C, °F
Resolution	0.1°C, 0.1°F
Pipes diameter	max 100 mm (max. 3.9")
Cable	2 m (6 ft) length with strengthened 3-point jack connector, Ø3.2 mm, in PVC, max. temperature 105°C (221°F)
Storage temperature	From -20 to 50°C (-4 to 122°F)

- **Si-RT7 probe**

Temperature	
Temperature sensors	NTC
Temperature sensor range	-20 to 85°C (-4 to 185°F)
Temperature accuracy*	±1°C (±1.8°F)

Maximum operating temperatures	Jaws: 85°C (185°F) - Handle: 50°C (122°F)
Available units	°C, °F
Resolution	0.1°C, 0.1°F
Pipes diameter	6 to 42 mm (0.2" to 1.7")
Device	
Power supply	3x LR03 AAA 1.5 V alkaline batteries
Battery life	150 h @ 20°C / 68°F
Wireless frequency	Range frequency from 2402 MHz to 2480 MHz with a transmission power of 8 dBm.
Wireless range	Range between manifold and wireless probes up to 100 m (328 ft). App connection: depends on smartphone radio strength, range up to 100 m (328 ft).
Compatibility	Smartphone minimum required versions: Android 11.0, iOS 15, BLE 5.0**
Connections	1x 1/4 FFL female
Storage temperature	From -20 to 50°C (-4 to 122°F)
Environmental conditions of use	In non-condensing condition Altitude: from 0 to 2000 m (0 to 6561') Non-corrosive gases
European directives	2015/863 EU (RoHS 3); 2012/19/EU WEEE; 2014/53/EU RED

*All accuracies specified in this document were conducted under laboratory conditions and can be guaranteed for measurement carried out in the same conditions, or carried out with calibration compensation. **Can work with BLE4.0 but the wireless range will be downgraded.

4.5 List of refrigerant gases

The following refrigerants are currently supported in the Si-RM350 and Si-RM450 manifolds. As more refrigerants are made available they can easily be added in the manifold internal memory with a firmware update using the Sauermann Pilot APP.

R11	R161	R407A	R419B	R444A	R503
R113	R170	R407B	R420A	R444B	R504
R114	R218	R407C	R421A	R445A	R507A
R115	R22	R407D	R421B	R446A	R508A
R1150	R227	R407E	R422A	R447A	R508B
R116	R23	R407F	R422B	R448A	R509A
R12	R236ea	R407H	R422C	R449A	R511A
R123	R236fa	R408A	R422D	R450A	R513A
R1233zd(E)	R245ca	R409A	R422E	R452A	R600
R1234yf	R245fa	R409B	R423A	R452B	R600a
R1234zeE	R290	R410A	R424A	R453A	R601
R1234zeZ	R32	R410B	R425A	R454A	R601a
R124	R41	R411A	R426A	R454B	R718
R125	R401A	R411B	R427A	R454C	R744
R1270	R401B	R412A	R428A	R455A	R744a
R13	R401C	R414A	R434A	R456A	
R134a	R402A	R414B	R437A	R458A	
R13b1	R402B	R416A	R438A	R466A	
R14	R403A	R417A	R439A	R469A	

R141b	R403B	R417B	R440A	R50
R142b	R404A	R417C	R441A	R500
R143a	R405A	R418A	R442A	R501
R152a	R406A	R419A	R443A	R502

The refrigerants are available by pressing  from the Refrigeration, Filling / Recovery, One-Way Refrigeration, Target Superheat and Compressor tests.

The last 10 refrigerants used automatically show up on the top of the list. Below the dynamic top 10 list the additional refrigerants available (total 130+) are listed in numerical order.

4.6 Gliding refrigerants

The Si-RM350 and Si-RM450 automatically take bubble point and dew point into account for gliding refrigerants.

The gliding of refrigerants refers to a thermodynamic phenomenon affecting non-azeotropic refrigerant mixtures. During evaporation or condensation, the components of the mixture change phase at different temperatures, leading to a distinction between bubble point and dew point temperatures.

Evaporator values displayed on the manifold are calculated using the refrigerant's dew-point temperature, derived from pressure measurement.

Condenser values displayed on the manifold are calculated using the refrigerant's bubble-point temperature, derived from pressure measurement.

5. Start with the manifold

5.1 Power supply

Before starting-up the manifold, please insert the batteries.

- Open the battery cover.
- Insert the 4 LR6 AA 1.5 V batteries.



Respect the polarity.



For long term measurements, it is possible to power the manifold via the USB-C connector. This does not charge batteries.

5.2 First start-up

- Starts the device pressing , parameters of the manifold must be set.

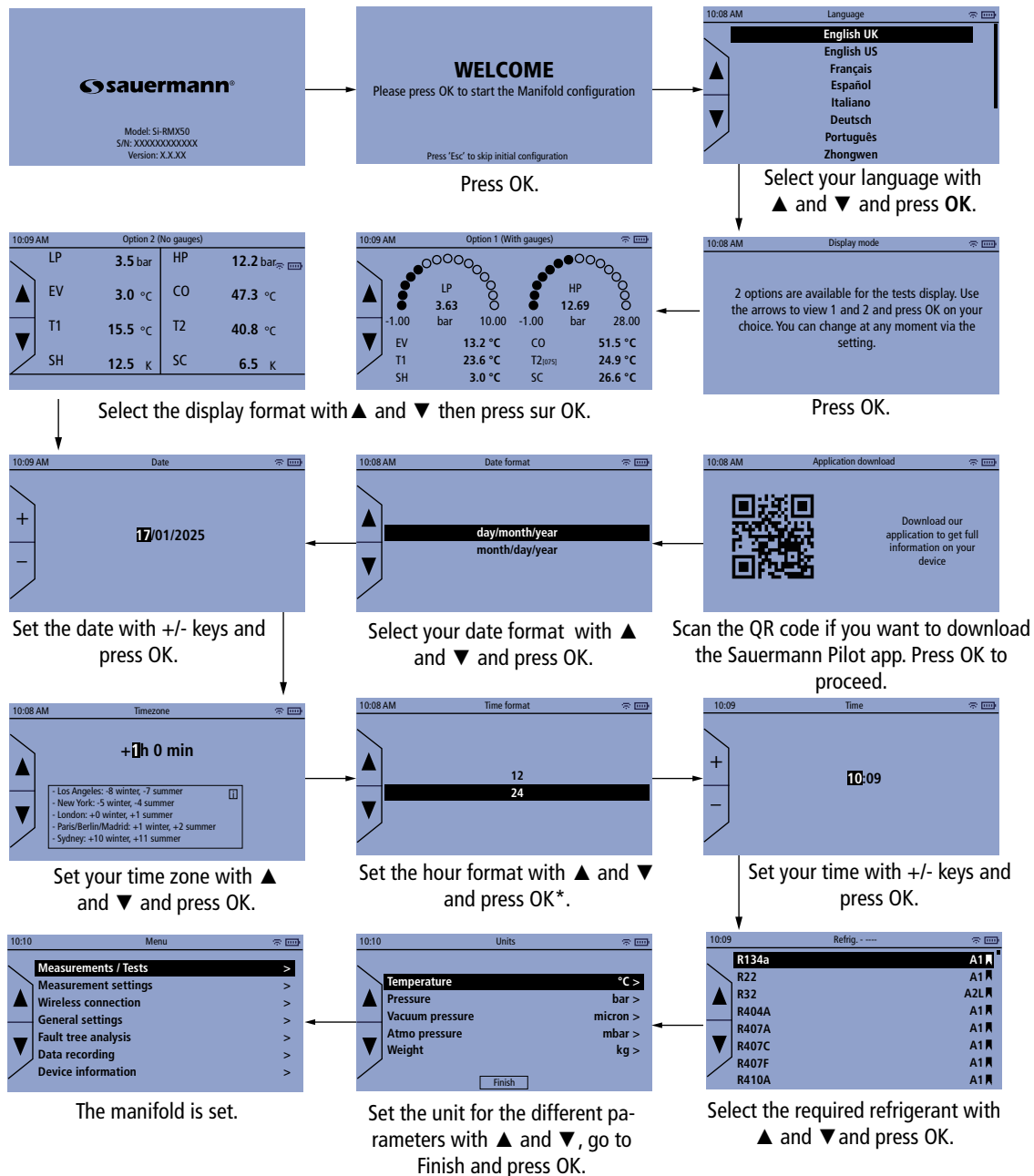

*if "12" is selected, the "PM" or "AM" selection screen will be displayed.



Once set, the next time you restart, the manifold will display the test selection screen. Press Esc to return to the main screen.

6. Connect a probe and the scale

6.1 Wired probe

The device has two inputs allowing the connection of wired temperature probes:

- Si-RT2 temperature clamp
- Si-RT5 temperature probe with hook-and-loop fastener

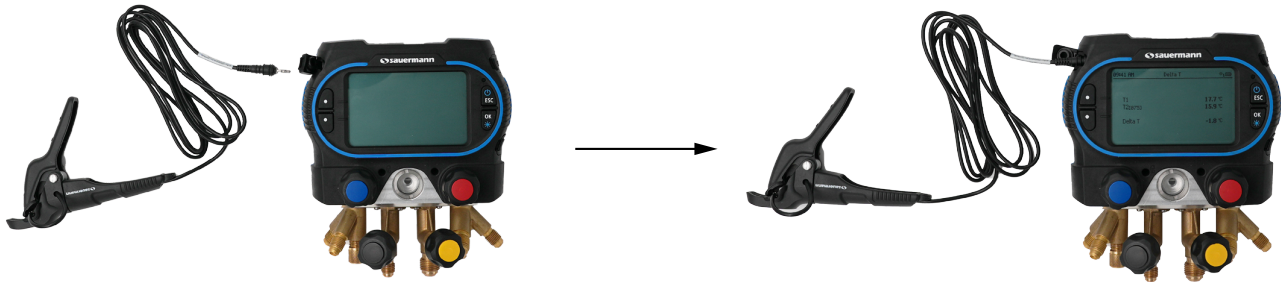

6.2 Wireless probe

The following wireless probes are available:

- Si-RT7 temperature clamp
- Si-TH4 temperature and humidity (psychrometer) probe
- Si-RV4 vacuum probe

When using a wireless probe for the first time, you must scan the probe before using it.

6.2.1 Scan a probe

The main menu is displayed.

- Turn on the wireless probe.

LED turns on and is fixed.

- Make sure wireless communication is activated.
- Press OK on "**Wireless connection**" line.
- Press OK on "**Scan devices**" line.

The probe name (e.g. Si-RT7) and its serial number are displayed.

- Press OK.

The connection is in progress then the probe is connected:

- *the LED on the probe blinks.*
- *probe name, type of probe, serial number, address and firmware version of the probe are displayed.*
- Press OK.
- For Si-RT7 probes only: select the usage for this probe: press OK on T1, T2 or T3.
- For Si-TH4 probes only: select the usage for this probe: press OK on WB or DB temperatures.
- Press ESC to back to main menu.



Once a probe is paired to the manifold, you can perform your measurements.

You can turn off the probe then turn it on. It will be recognized by the manifold, there's no need to scan it again.

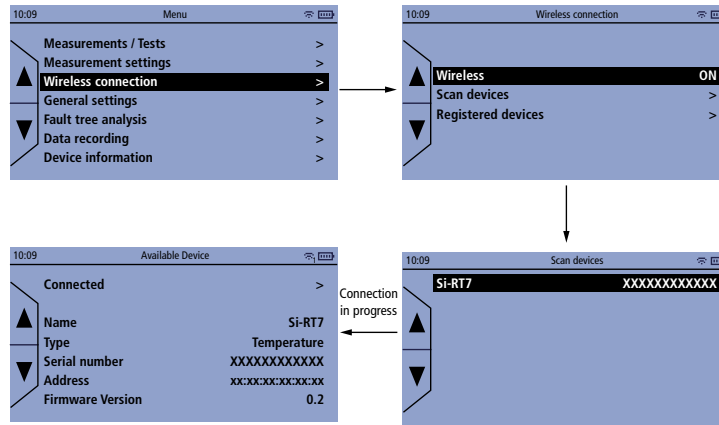

6.2.2 Information about probes

Once a probe is paired, it is registered in the manifold with its features.

"Wireless connection" menu is displayed.

- Press OK on "Registered devices" line.

Probes registered in the manifold are displayed.

- Press OK on the line of the required probe.

Probe name, type of probe, serial number, address, firmware version and usage of the probe are displayed.



In case of trouble with your probe and when contacting the after-sale service or the hotline, this information will be useful.

For Si-TH4 and Si-RT7 probes, from this screen, it is possible to modify the assignment:

- Go to "Usage" and press OK.
- Press OK on T1, T2 or T3.

From this screen, it is also possible to delete the probe:

- Go to "Remove" and press OK.

6.3 Scale

The Si-RS1 scale can be connected to the manifold through wireless.

6.3.1 Scan the scale

The main menu is displayed.

- Turn on the Si-RS1 scale.
- Make sure wireless communication is activated.
- Press OK on "Wireless connection" line.
- Press OK on "Scan devices" line.

The scale name "Si-RS1" is displayed.

- Press OK.

The connection is in progress then the scale is connected.



Once a scale is paired to the manifold, you can perform your measurements.

You can turn off the scale then turn it on. It will be recognized by the manifold, there's no need to scan it again

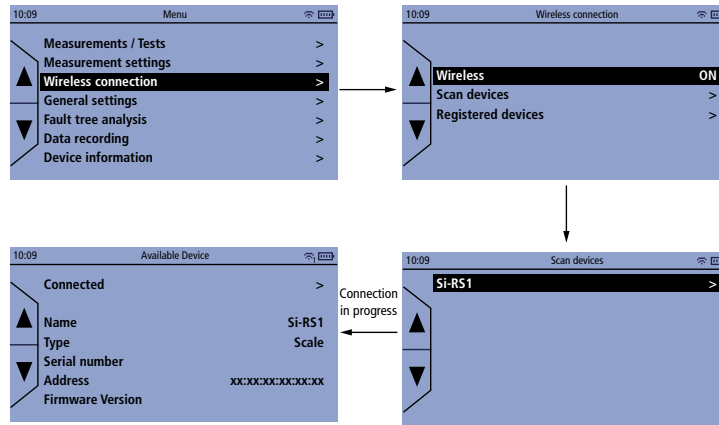

6.3.2 Information about the scale

Once a scale is paired, it is registered in the manifold with its features.

"Wireless connection" menu is displayed.

- Press OK on "**Registered devices**" line.
Scale registered in the manifold is displayed.
- Press OK on the line of the scale.
Features of the scale are displayed

From this screen, it is possible to delete the probe:

- Press OK twice to remove it.

7. Set the device

"General Settings" menu allows to set the following items for the manifold:

- Language
- Date
- Time
- Timezone
- Autopower off
- Backlight
- Display mode

To access this menu:

- From the main menu, go to "General settings" and press OK.

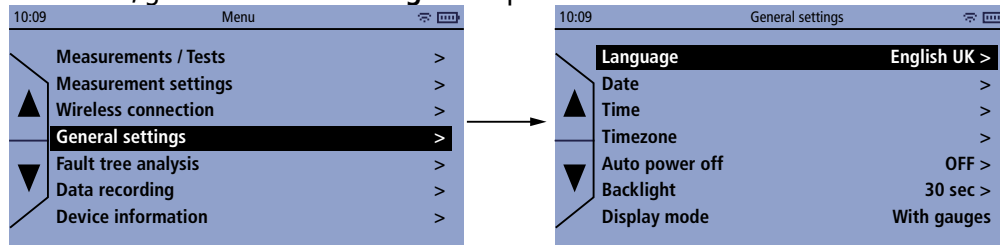

7.1 Set the language

"General settings" menu is displayed.

- Press OK on "Language" line.
- Press OK on the requested language line.

 Available languages: English UK (United Kingdom), English US (United States), French, Spanish, Italian, German, Portuguese, Chinese, Dutch, Hungarian, Polish and Romanian.

7.2 Set the date format

"General settings" menu is displayed.

- Press OK on "Date" line.
- Select the date format: day/month/year or month/day/year with ▲ and ▼ and press OK.

7.3 Set the time format

"General settings" menu is displayed.

- Press OK on "Time" line.
- Select the time format: 12 or 24 with ▲ and ▼ and press OK.

7.4 Set the timezone

"General settings" menu is displayed.

- Press OK on "Timezone" line.
- Adjust the timezone with ▲ and ▼ and press OK.

7.5 Set the autopower off

- Press OK on "Autopower off" line.
- Press OK to enable: ON or disable: OFF the autopower off.
- If ON is selected: press OK on "Value" line to set the duration in minutes: 5/10/15/30/45/60 min.

7.6 Set the backlight

- Press OK on "Backlight" line.

- Select the duration of the backlight: 30 sec / 60 sec / 10 min or always with ▲ and ▼ and press OK.

7.7 Select the display mode

"General settings" menu is displayed.

- Press OK on "**Display mode**" line.
- Press on OK on the screen explaining the two available display options.
- Press ▲ and ▼ to select the display mode: with gauges or without gauges.

8. Set the measurement parameters

"**Measurement settings**" menu allows to set units, temperature compensation, pressure type and atmospheric pressure.

To access this menu:

- From the main menu, go to "**Measurement settings**" and press OK.

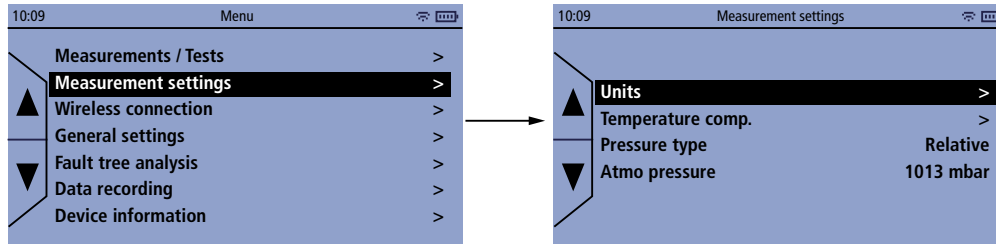

8.1 Set the units

The following units can be set for these different parameters:

- Temperature: °C, °F
- Pressure: bar, psi, MPa, kPa
- Vacuum pressure: micron, Pa, hPa, mbar, mTorr, mmHg, inH₂O, inHg, Torr
- Atmospheric pressure: mbar, hPa, inHg, bar, psi
- Weight: kg, lb, oz

"**Measurement settings**" menu is displayed.

- Press OK on "**Units**" line.
- Press OK on the required parameter line.
The list of available units is displayed.
- Select the unit with with ▲ and ▼ and press OK.

8.2 Set the temperature compensation

A temperature compensation factor has been set in the instrument to reduce the errors when measuring pipe temperature in the main field of applications. This reduces measuring errors for Si-RT2, Si-RT5 and Si-RT7 when measuring surface temperature.

For measuring contact temperature, the compensation must be turned on and for measuring surface temperature, the compensation must be turned off.

When doing calibration with temperature sensor in a bath the temperature compensation should be turned off.

"**Measurement settings**" menu is displayed.

- Press OK on "**Temperature comp.**" line.
- Press OK on "**Temperature compensation**" line to switch between ON and OFF.
- Select the type of probe to be used for the temperature compensation:
 - Press OK on "**Wired Port 1**" or "**Wired Port 2**".
 - Press OK on "**Velcro**" or "**Clamp**".

8.3 Set the pressure type

"**Measurement settings**" menu is displayed.

- Press OK on "**Pressure type**" line to switch between "**Relative**" and "**Absolute**".

8.4 Set the atmospheric pressure

"**Measurement settings**" menu is displayed.

- Press OK on "**Atmo pressure**" line.
- Define the atmospheric pressure value with + and - and press OK.



The atmospheric pressure value must be between 400 and 1200 mbar.

9. Perform a refrigeration test

The refrigeration test allows to measure and calculate the following parameters:

- Low pressure / High pressure
- Refrigerant evaporator temperature
- Pipes temperatures
- Superheating temperature
- Subcooling temperature
- Refrigerant condenser temperature

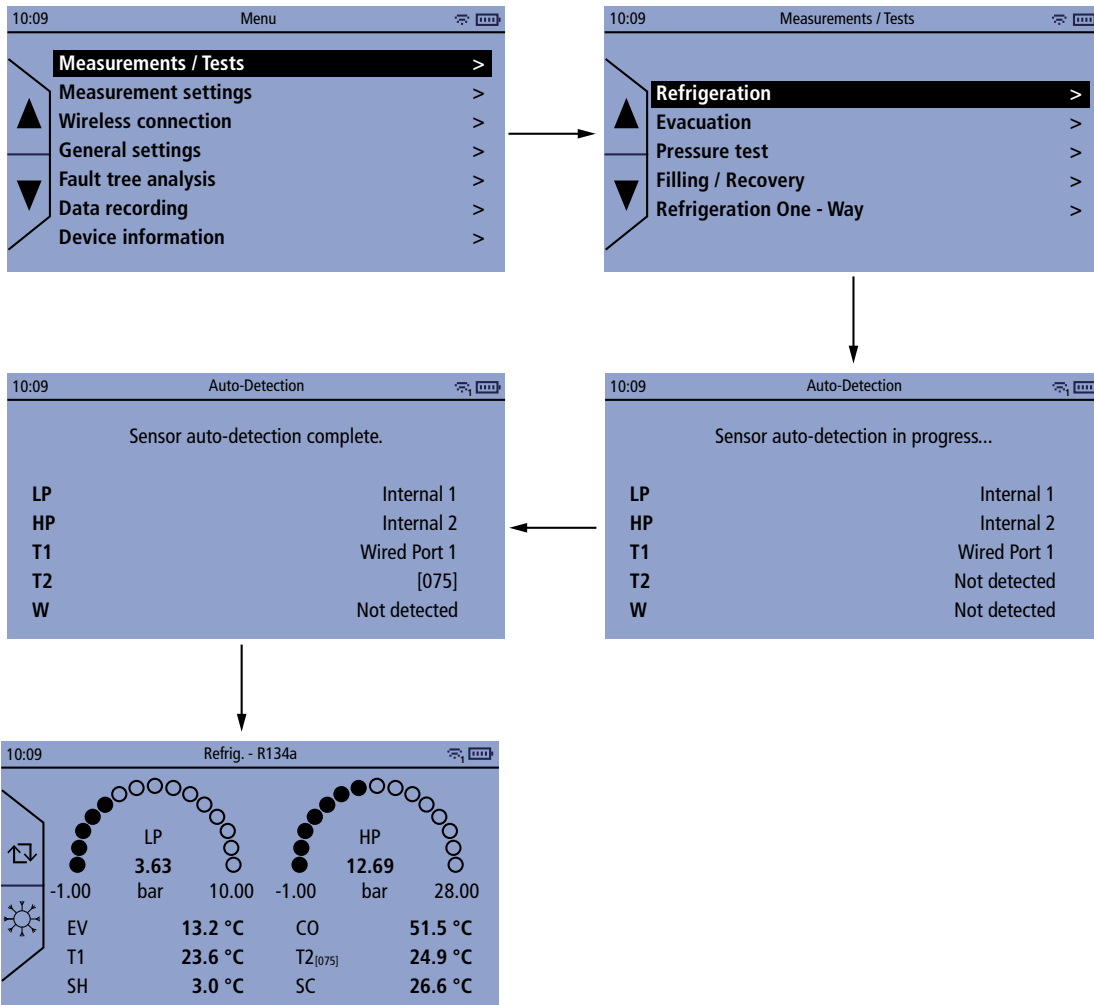

Before each test it is recommended to zero the pressure sensors in ambient pressure, before connecting hoses.

It is only possible to zero pressure with less than 0.9 bar pressure measured, to avoid accidental zero.

- Perform an autozero by pressing  for 3 seconds.
- Connect the pressure hoses to the manifold and to the installation.
- Connect the required probes (wired or wireless).
- Press OK on "Measurements/Tests" line.
- Press OK on "Refrigeration" line.

Once the auto-detection is complete:

- Select the required refrigerant by pressing  .

Reversible systems:

If working on a reversible system you can use the manifold refrigeration test first in cooling mode on the installation. Once you switch to heating mode on the installation and the manifold detects that the pressure sensor

on the left detects higher pressure than the pressure sensor on the right you will get a notification and a possibility to switch the measurements. Switching the measurements means that the pressure sensor on the left will be used for HP pressure, the temperature probe previously associated with T1 will be used to measure T2 (for example wired port 1 will measure T2), and Subcooling will be calculated based on the pressure sensor on the left and associated temperature. Likewise the Left side moves to the Right.

10. Evacuation function

The Evacuation test (pulling deep vacuum) allows you to measure the level of vacuum, to help you to ensure that all gases and humidity have been eliminated from the refrigeration circuit.

 The Si-RV4 vacuum probe is required to perform this measurement.

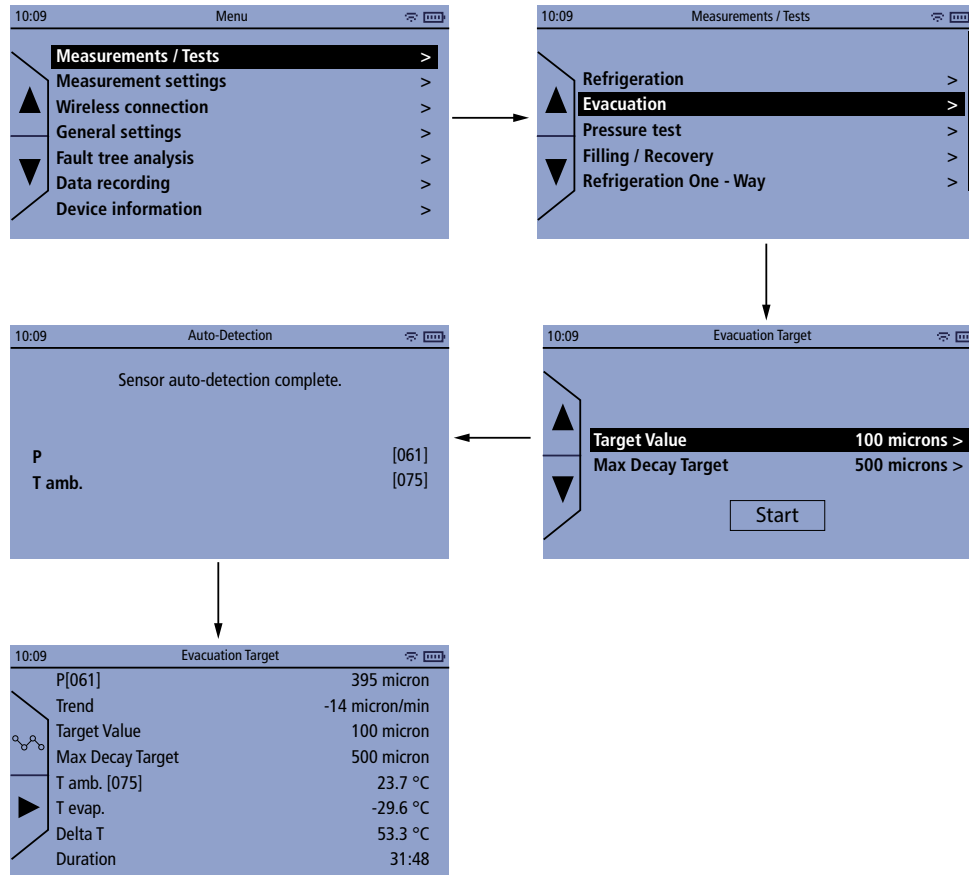

"Measurements / Tests" menu is displayed.

- Press OK on "**Evacuation**" line.
- Set the target value.
- Set the max decay target.
- Press OK on "**Start**" button.
- *The manifold displays various parameters corresponding to evacuation:*
 - *Actual pressure*
 - *Trend*
 - *Target and max decay target values*
 - *Ambient and evaporation temperature*
 - *Delta T*
- Connect the required evacuation material (Si-RV4 vacuum probe and Si-RVPx vacuum pump) to the manifold and to the installation.
- Press ► to start the evacuation test:
Measurements and duration are displayed.
- Press  to display the target and max decay target values as graph.
- Once the required duration for the evacuation is reached, press ■.

11. Perform a pressure test

The pressure test allows to check if there are any leaks in the system. To perform this test, the system pressure will be measured over a period of time.

For a temperature compensated test the ambient temperature can be taken into account. This allows the manifold to compensate measured pressure based on NO2 pressure at different temperatures.

To measure the ambient temperature a Si-TH4 is preferred. If a Si-RT2, Si-RT5 or Si-RT7 is used ensure the Temperature compensation is turned off (chapter 8.2).

 Pressure test always uses the pressure sensor on the right of the manifold (typically the HP sensor).

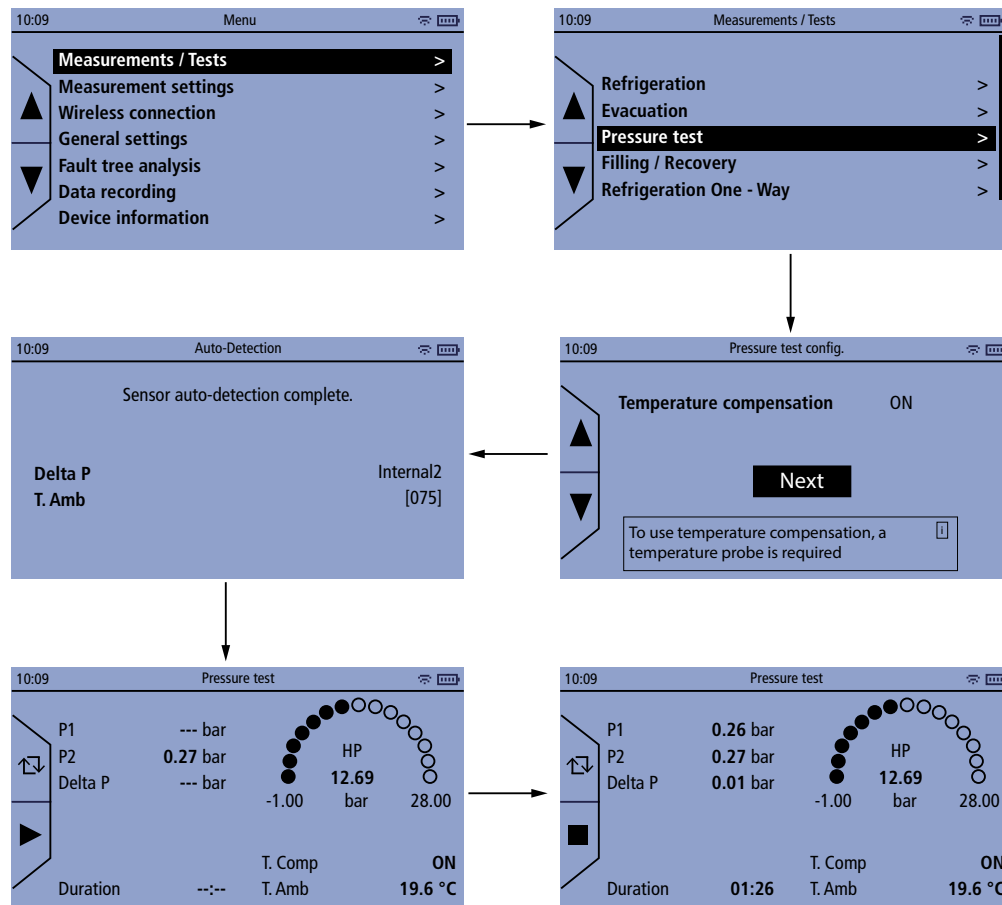



 Before each test it is recommended to zero the pressure sensors in ambient pressure, before connecting hoses.

It is only possible to zero pressure with less than 0.3 bar pressure measured, to avoid accidental zero.

- Perform an autozero by pressing  for 3 seconds.
- Connect a pressure hose to the manifold and to the installation.
- Connect a temperature probe (wired or wireless).
- Press OK on "Measurements/Tests" line.
- Press OK on "Pressure test" line.
- Press OK on Next button.

Once the auto-detection is complete:

- Press  to start the pressure test.
- Press  once the required duration is reached.

12. Filling / Recovery function

 For the filling / recovery function, a Si-RS1 digital refrigerant scale is needed.

12.1 Filling mode

 This function enables a refrigerant circuit to be charged manually via weight using the Sauer mann Si-RS1 digital refrigerant scale in combination with the Si-RM350, Si-RM450 or Pilot App. The test shows how much refrigerant is charged while also displaying pressures and temperature like Superheat and Subcooling. A target weight to charge can be set. By manually opening and closing the refrigerant bottle valve, the system is charged.

 The system must be supervised by a competent person throughout the entire process.

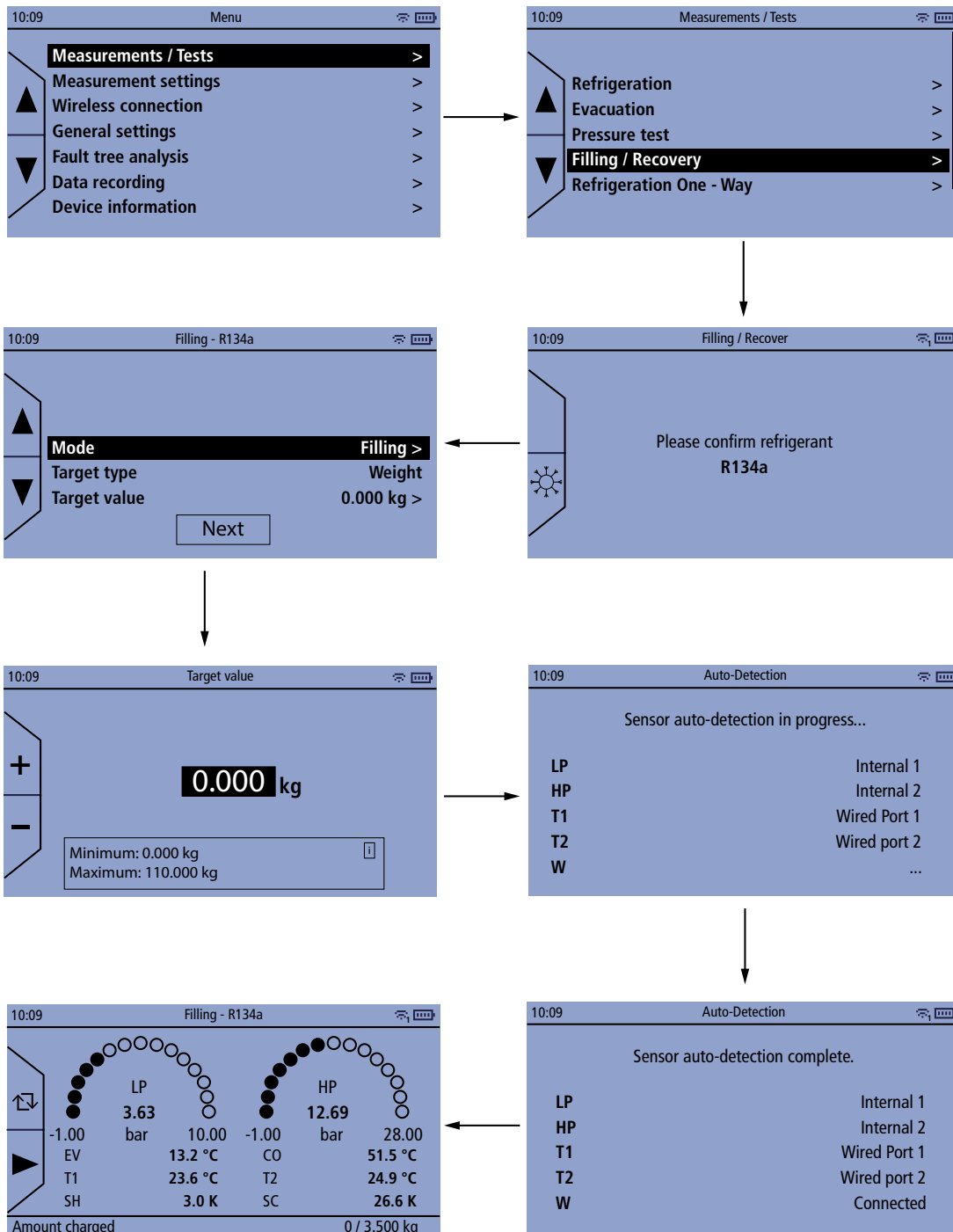

"Measurements / Tests" menu is displayed.

- Press OK on "**Filling / Recovery**" line.
- Press OK to confirm the refrigerant used or select the required one by pressing 
- Press OK on "**Mode**" line and select "**Filling**" mode.
- Enter the target value on "**Target Value**" line between 0 and 110 kg.
- Press OK on Next.
- Turn on the Si-RS1 scale.
- Connect two wired temperature probes or use wireless probes.
- Press OK once the manifold has complete the auto-detection.
Value are displayed on the manifold screen.
- Press "**Play**" before opening the valve on the bottle. After pressing "**Play**" the test automatically tracks the delta weight on the Si-RS1, so you can easily see how much refrigerant has been added to the system.
- To change bottle press "**Pause**". When the new bottle is ready press "**Play**" again and the test continues to track total delta weight (combining first and second bottle).
- When finishing the test, press "**Stop**" then "**Save**" to save the type of refrigerant, time, and amount of refrigerant charged in the manifold memory.

12.2 Recovery mode



This function allows you to track how much refrigerant has been recovered using the Sauer mann Si-RS1 digital refrigerant scale in combination with the Si-RM350, Si-RM450 or Pilot App. The test shows how much refrigerant is recovered while also displaying pressures and temperature like Superheat and Subcooling.

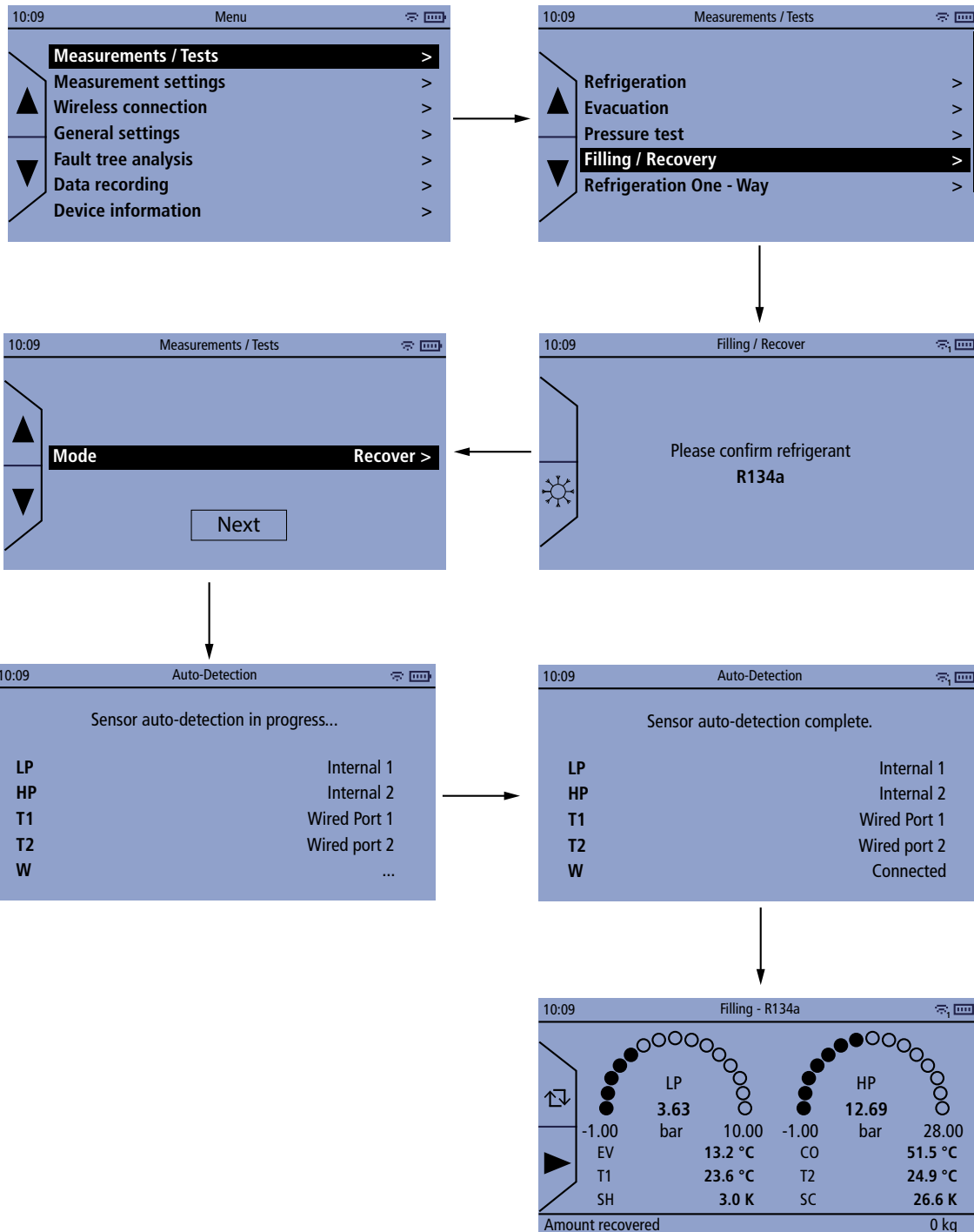

"Measurements / Tests" menu is displayed.

- Press OK on "Filling / Recovery" line.
- Press OK to confirm the refrigerant used or select the required one by pressing .
- Press OK on "Mode" line and select "Recover" mode.
- Press OK on Next.
- Turn on the Si-RS1 scale.
- Connect two wired temperature probes or turn on wireless probes.
- Press OK once the manifold has complete the auto-detection.
Value are displayed on the manifold screen.
- Press "Play" before opening the valve on the bottle. After pressing "Play" the test automatically tracks the

delta weight on the Si-RS1, so you can easily see how much refrigerant has been recovered.

- When finishing the test, press "**Stop**" then "**Save**" to save the type of refrigerant, time, and amount of refrigerant recovered in the manifold memory.

13. Perform a refrigeration one-way test

Refrigeration one-way test is useful for a quick test when you do not wish to connect both Low pressure and High pressure, but only one pressure and you want to control if you are measuring Subcooling or Superheat especially for gliding refrigerants. The one-way refrigeration test allows to measure and calculate the following parameters:

- High pressure OR Low pressure
- Refrigerant condensor temperature OR Refrigerant evaporator temperature
- Pipes temperatures
- Subcooling temperature OR Superheating temperature

i Refrigeration one-way test always uses the pressure sensor on the right of the manifold (typically the HP sensor) and input for T2 temperature probe. If you switch to LP measurement it is still using the pressure sensor on the right, and the T2 probe input. Calculations are updated for gliding refrigerants to ensure pressure is correctly converted to temperature depending on if you measure HP or LP.

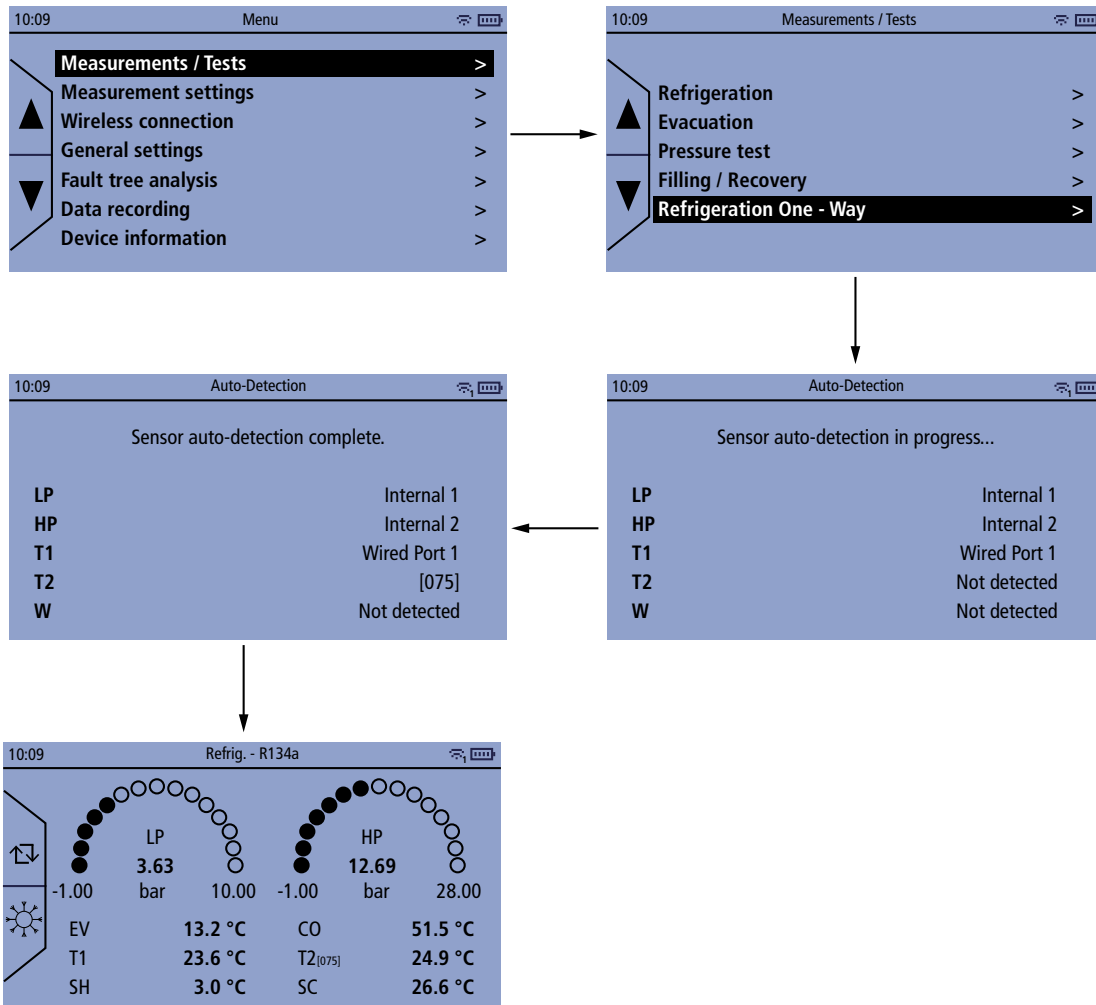

i Before each test it is recommended to zero the pressure sensors in ambient pressure, before connecting hoses.

It is only possible to zero pressure with less than 0.9 bar pressure measured, to avoid accidental zero.

- Perform an autozero by pressing  for 3 seconds.
- Connect the pressure hoses to the manifold and to the installation.
- Connect the required probes (wired or wireless).
- Press OK on "Measurements/Tests" line.
- Press OK on "Refrigeration One - Way" line.

Once the auto-detection is complete:

- Select the required refrigerant by pressing  .

14. Calculate the target superheat

The manifold allows to calculate the target superheat. This test can only be used for split air conditioning systems/ heat pumps with a fixed expansion valve. The target superheat value appears on the display as a result of the outdoor dry bulb temperature (DB) and return air wet bulb temperature (WB).

 To calculate this value, outdoor dry bulb temperature (DB) and return air wet bulb temperature (WB) can be manually entered or measured by temperature probes.

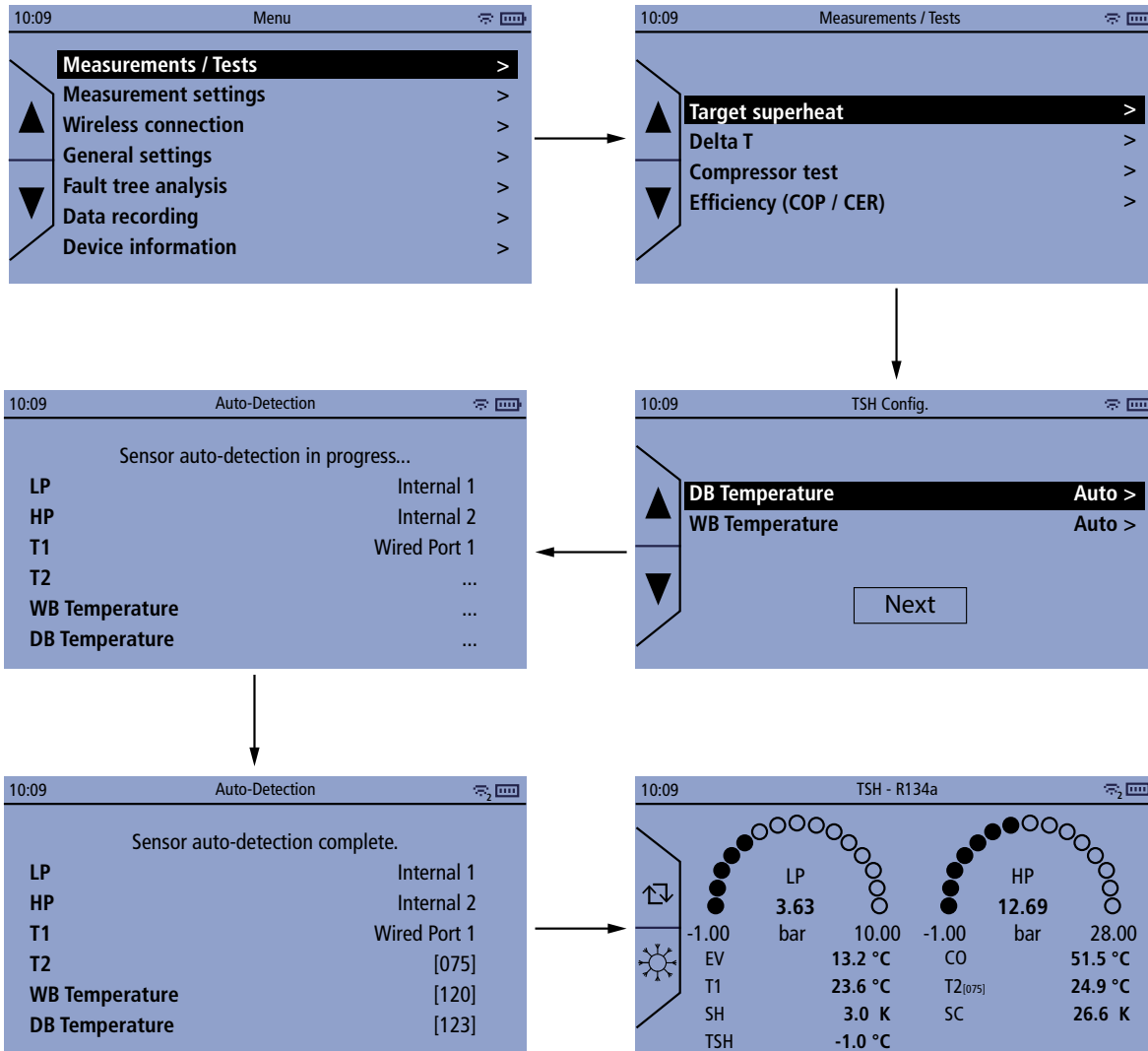

 Before each test it is recommended to zero the pressure sensors in ambient pressure, before connecting hoses.
It is only possible to zero pressure with less than 0.3 bar pressure measured, to avoid accidental zero.

"Measurements / Tests" menu is displayed.

- Press OK on "**Target superheat**" line.
DB temperature and WB temperatures lines are displayed.
- Press OK to select "**Auto**" or to enter manually the value.
- Press OK on "**NEXT**".
- Press OK once the manifold has complete the auto-detection.
- Perform an autozero by pressing  for 3 seconds.
Results are displayed on the manifold screen.

15. Perform a delta T measurement

The delta T measurement allows to measure the temperature difference between T1 and T2.



Two temperature probes are needed to perform this measurement. We recommend using Si-RT2, Si-RT5 and/ or Si-RT7 temperature probes.

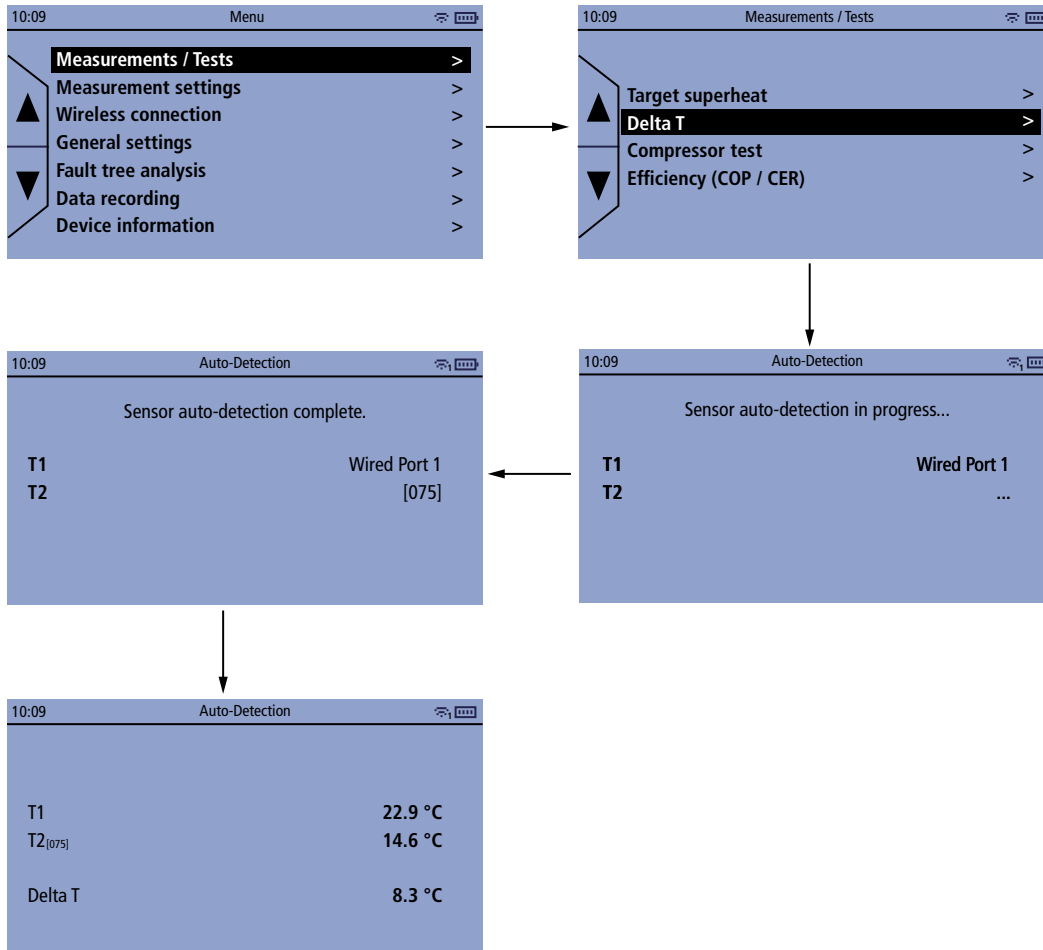

"Measurements / Tests" menu is displayed.

- Press OK on "**Delta T**" line.
- Press OK once the manifold has complete the auto-detection.
- Temperatures are displayed:
 - T1 temperature
 - T2 temperature
 - Delta T: T2 - T1

16. Perform a compressor test

The compressor test function allows to check that the compressor of the refrigeration system is operating correctly (depending on the inlet and outlet temperatures).

 Three temperature probes are needed to perform this measurement. Minimum one Si-RT7 will be necessary. T3 is the discharge line temperature (DLT).

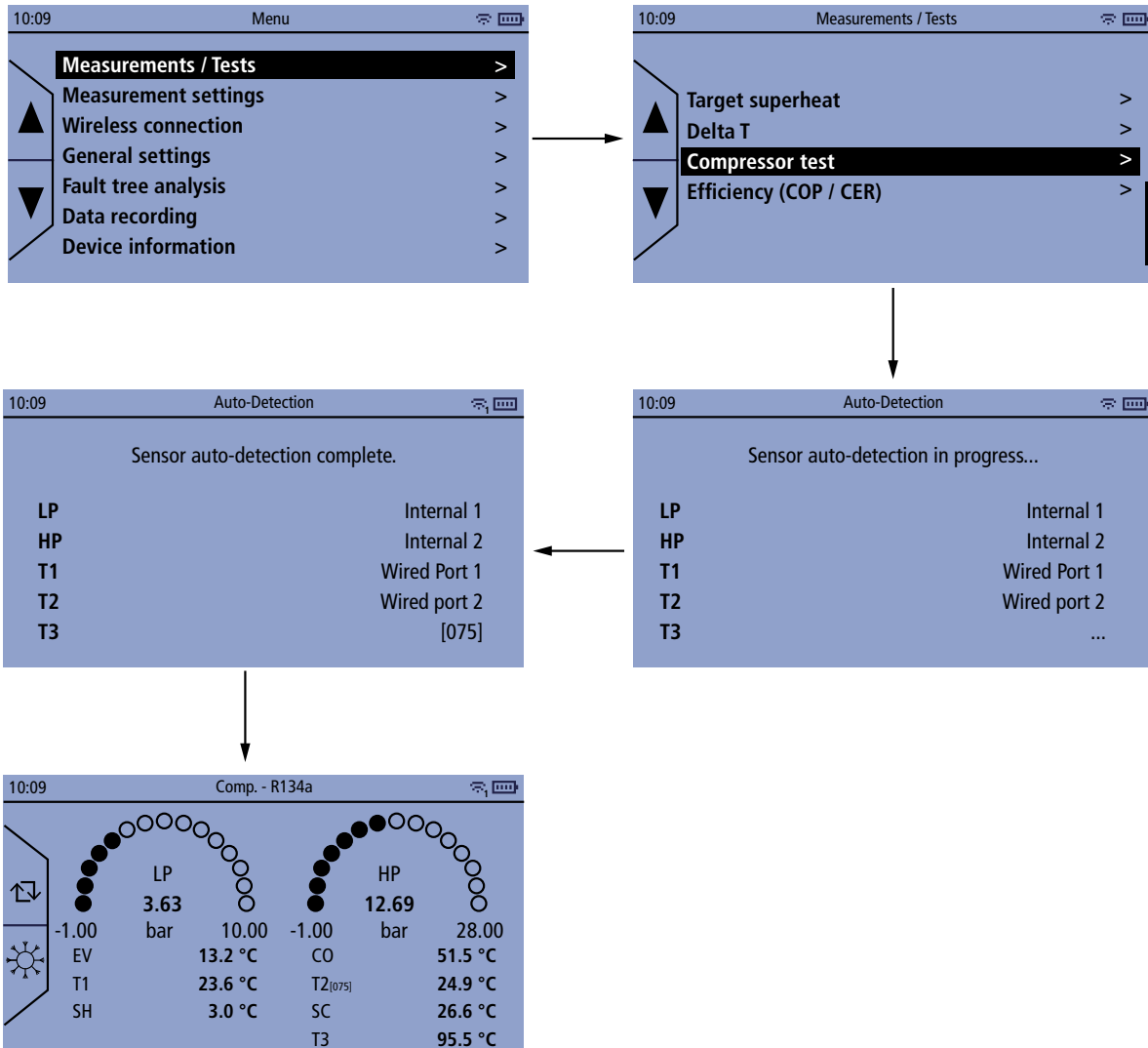

 Before each test it is recommended to zero the pressure sensors in ambient pressure, before connecting hoses.

It is only possible to zero pressure with less than 0.3 bar pressure measured, to avoid accidental zero.

"Measurements / Tests" menu is displayed.

- Press OK on "Compressor test" line.
- Press OK once the manifold has complete the auto-detection.
- Perform an autozero by pressing  for 3 seconds.
Results are displayed on the manifold screen.

17. Calculate the efficiency of the installation

The manifold allows to calculate the COP (coefficient of performance) for an installation using water or air and the EER (Energy Efficiency Ratio).

17.1 Coefficient of performance

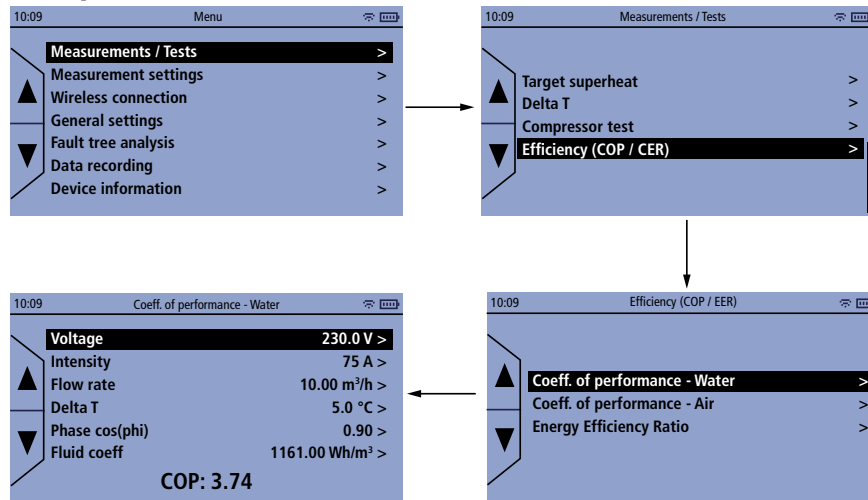

"Measurements / Tests" menu is displayed.

- Press OK on "Efficiency (COP / EER)" line.
- Press OK on "Coeff. of performance - Water" or "Coeff. of performance - Air" line according to your need.
- Enter manually the following parameters to calculate the COP:
 - Voltage: between 0 and 1000 V
 - Intensity: between 0 and 1000 A
 - Flow rate: between 0 and 1000 m³/h
 - Delta T: between -200 and 200 °C (-328 to 392 °F)
 - Phase cos(phi): between 0 and 1
 - Fluid coeff in Wh/m³

17.2 Energy Efficiency Ratio

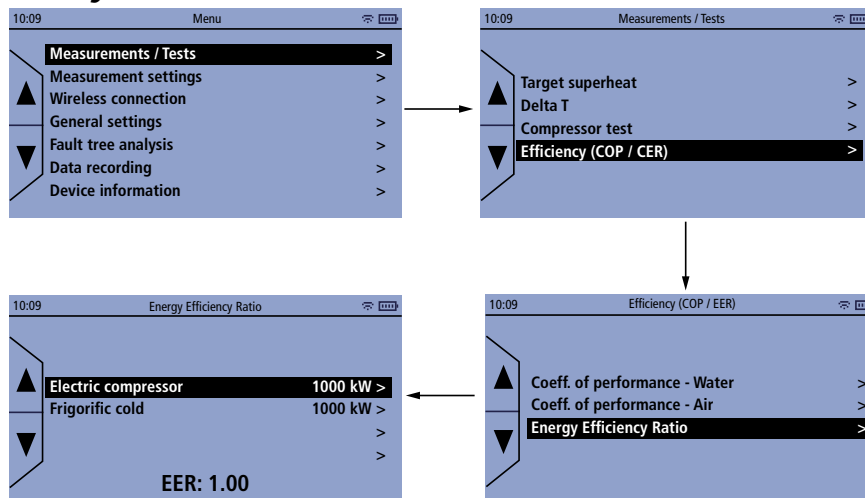

"Measurements / Tests" menu is displayed.

- Press OK on "Efficiency (COP / EER)" line.
- Press OK on "Energy Efficiency Ratio" line.
- Enter manually the following parameters to calculate the EER:
 - Electric compressor: between 0 and 10000 kW
 - Frigorific cold: between 0 and 10000 kW

18. Data recording

The manifold allows to save measured data in its internal memory. Before starting a data recording features of this recording must be set:

- Selected measures: parameters to be recorded
- Interval: time interval between which the values will be recorded
- Duration: duration of the data recording

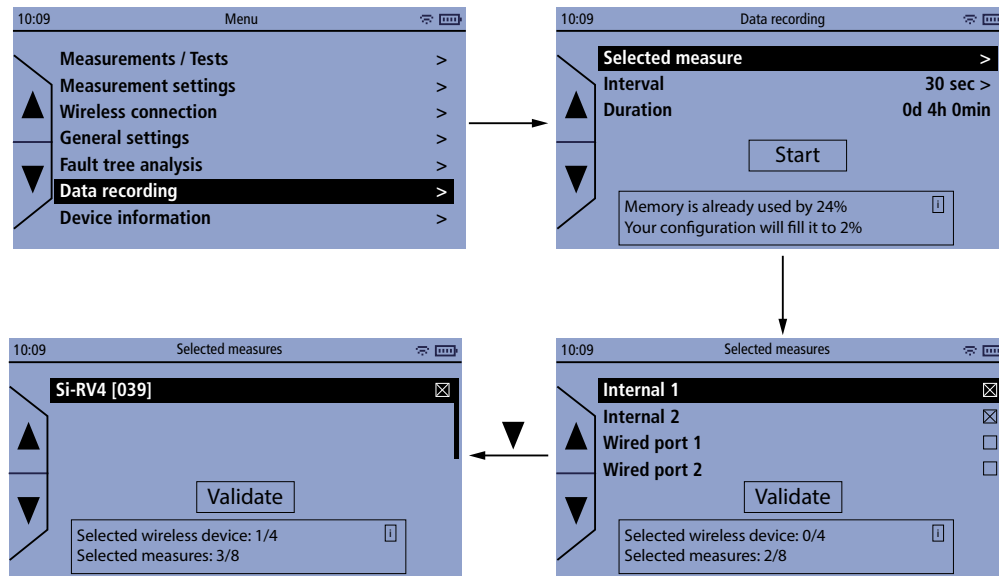

18.1 Set data recording features

18.1.1 Select measure to save

"Data recording" menu is displayed.

- Press OK on "Selected measure" line.
- Press OK to tick or untick the box corresponding to the channel to save.
- Press OK on "Validate".

18.1.2 Set the measurement interval

"Data recording" menu is displayed.

- Press OK on "Interval" line.
- Set the measurement interval between 10 s and 3600 s with + and - and press OK.

18.1.3 Set the recording duration

"Data recording" menu is displayed.

- Press OK on "Duration" line.
- Set the recording duration in day/hour/minute with + and - and press OK.

18.2 Launch the data recording

Once data recording features have been set, it is possible to launch the recording.

"Data recording" menu is displayed.

- Press OK on "Start".
The manifold displays the auto-detection screen.
- Press OK.

Data recording starts. Measured and saved values are displayed. At the end of the recording, the manifold displays a message indicating the end of the recording.

 Saved data can be imported in the Sauermann Pilot app and then exported. Please see the Sauerman Pilot app user manual for further details.

 Data recording can be stopped at any time by pressing Esc key.

 The time duration that the test has run is displayed in minutes (it will take 60 seconds before you see the time moving).

18.3 Erase data stored in the manifold

After transferring data to the Sauermann Pilot app, it is possible to delete them from the manifold.

From the main menu:

- Press OK on "**Device information**" line.
- Press OK on "**Memory used**" line.
The percentage of memory used and the date of last synchronisation are displayed.
- Press OK twice on "**Delete**".
- Press OK to confirm the deletion.



Erased data can not be recovered.

19. Device information

The device information menu allows to access various information about the manifold:

- Serial number
- Firmware version
- PCB version
- Wireless module version
- Memory used
- Factory reset

To access this menu:

- From the main menu, go to **"Device information"** and press OK.

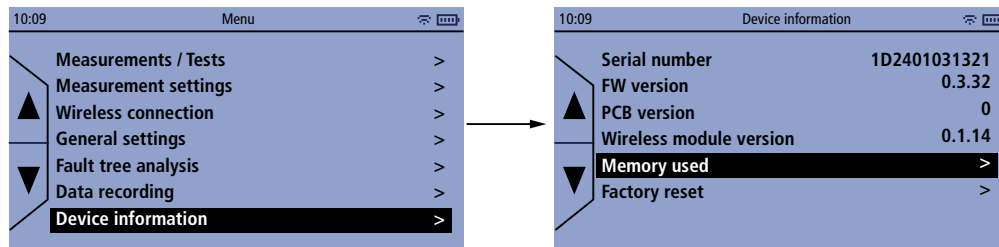

 In case of a trouble with your device and when contacting the after-sale service or the hotline, serial number, firmware version, PCB version and wireless module version will be useful.

19.1 Information about memory

"Device information" menu is displayed.

- Press OK on **"Memory used"** line.
Memory usage and date of last synchronization are displayed.

19.1.1 Erase memory

"Device information" menu is displayed.

- Press OK on **"Memory used"** line.
- Press OK twice.
The manifold displays a confirmation message.
- Press OK to confirm or Esc to cancel.



Erased data can not be recovered!

19.2 Reset instrument from factory settings

It is possible to reset the manifold to factory parameters.

"Device information" menu is displayed.

- Press OK on **"Factory reset"** line.
The manifold displays a confirmation message.
- Press OK to confirm or Esc to cancel.



The manifold will be reset to original delivery settings. All your configurations will be deleted.

Default settings (Factory):

Feature	Default value
Language	English
Temperature compensation	Activated

Ambient temperature compensation T1	Clamp
Ambient temperature compensation T2	Clamp
Date format	day/month/year
Time format	AM/PM
Wireless communication	Activated
Auto-power off	30 minutes
Backlight	OFF

20. Maintenance and precautions for use

20.1 Maintenance

Please avoid any aggressive solvents. Please protect the manifold, its connections and the hoses from any cleaning product containing formalin, that may be used for cleaning rooms or ducts.

20.2 Cleaning

- If the manifold housing is dirty, use a damp cloth to clean it.
- The connections must be clean and free of grease and other residues. If needed, use a damp cloth to clean them.
- Check regularly that the valve inlets are not blocked by oil/fluid residues. If needed, remove these residues before using the manifold.

20.3 Precautions for use

Please always use the device in accordance with its intended use and within parameters described in the user manual in order not to compromise the protection ensured by the device.

21. Overview of the manifold range

21.1 Overview

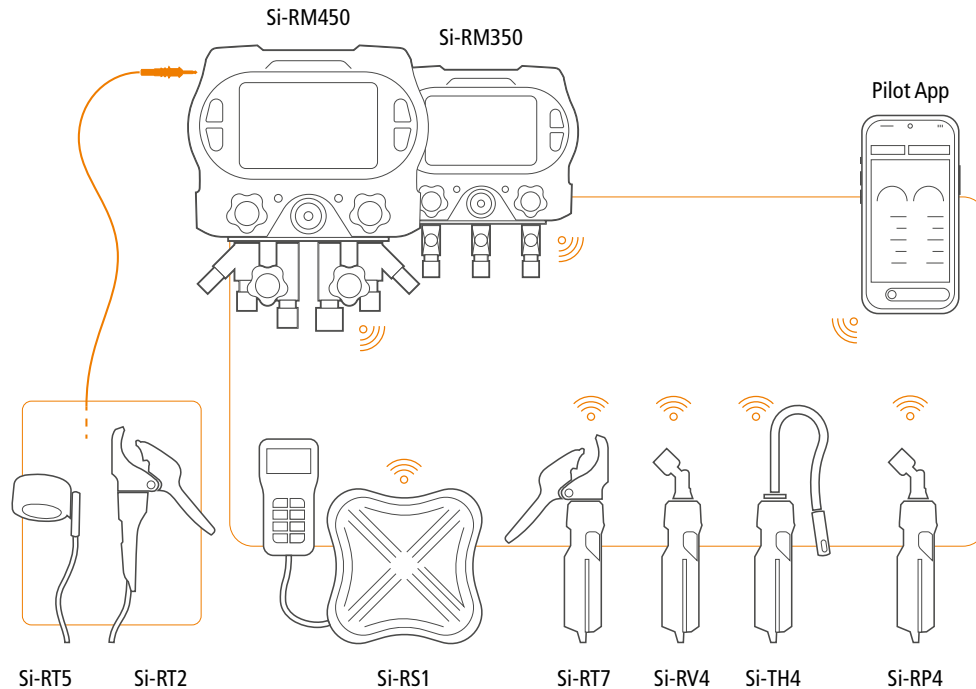

21.2 Accessories

Designation	Sales reference	Description
ACC25830	25830	2x connectors for system with R410 and R32. 1/4" MFL to 5/16" FFL
Si-RM6	26141	Extension cable 5 meters length for temp clamp.
Si-RS1	28153	Scale. Measurement range up to 110 kg (243 lbs). Wired remote with display. Wireless connection to manifold. Supplied in hard plastic case.
Si-RVP1-220V	28154	220 V, 85 l/min vacuum pump. 2-stage. Refrigerants: A2L. Ultimate vacuum: 15 microns.
Si-RVP3-220V	28156	220 V, 170 l/min vacuum pump. 2-stage. Refrigerants: A2L & A3. Ultimate vacuum: 15 microns.
Si-RVP1-110V	28155	110 V, 3 CFM vacuum pump. 2-stage. A2L refrigerants. Ultimate vacuum: 15 microns.
Si-RVP2-110V	28157	110 V, 6 CFM vacuum pump. 2-stage. Suitable for A2L. Ultimate vacuum: 15 microns.