

▪ CLAMP-ON METER

203



ENGLISH

User Manual

AEMC[®]
INSTRUMENTS
CHAUVIN ARNOUX GROUP

Statement of Compliance

Chauvin Arnoux[®], Inc. d.b.a. AEMC[®] Instruments certifies that this instrument has been calibrated using standards and instruments traceable to international standards.

We guarantee that at the time of shipping your instrument has met its published specifications.

An N.I.S.T. traceable certificate may be requested at the time of purchase, or obtained by returning the instrument to our repair and calibration facility, for a nominal charge.

The recommended calibration interval for this instrument is 12 months and begins on the date of receipt by the customer. For recalibration, please use our calibration services. Refer to our repair and calibration section at www.aemc.com.

Serial #: _____

Catalog #: #2139.12 _____

Model #: 203 _____

Please fill in the appropriate date as indicated:









Date Received: _____

Date Calibration Due: _____



Chauvin Arnoux[®], Inc.
d.b.a AEMC[®] Instruments
www.aemc.com

CONTENTS











RECEIVING YOUR SHIPMENT	7
ORDERING INFORMATION	7
1 PRESENTATION	8
1.1 ROTARY SWITCH	9
1.2 FUNCTION BUTTONS	10
1.3 DISPLAY	11
1.3.1 Display Symbols	11
1.3.2 Measurement Capacity Exceeded (OL)	12
1.4 TERMINALS	12
2 BUTTONS	13
2.1  HOLD BUTTON	13
2.2  (YELLOW) BUTTON (SECOND FUNCTION)	14
2.3  ☆ BUTTON	14
2.4  MAX/MIN BUTTON	15
2.4.1 Normal Mode	15
2.4.2 The MAX/MIN Mode + Activation of the HOLD Mode	16
2.4.3 Access to the True Inrush® Mode ( set switch to )	16
2.5  Hz BUTTON	17
2.5.1 Normal Mode	17
2.5.2 The Hz Function + Activation of the HOLD Mode	17
2.6  REL BUTTON	18
3 USE	19
3.1 INSTALLING THE BATTERY	19
3.2 TURNING THE CLAMP-ON METER ON	19
3.3 TURNING THE CLAMP-ON METER OFF	19
3.4 CONFIGURATION	20
3.4.1 Configuring the Maximum Resistance for Continuity	20
3.4.2 Auto Power OFF	20
3.4.3 Configuring the Current Threshold for True InRush® Measurement	20
3.4.4 Changing the Default Temperature Unit	21
3.4.5 Configuring the Adapter Function Scale Factor	21
3.4.6 Default Configuration	22
3.5 VOLTAGE MEASUREMENT (V)	22
3.6 CONTINUITY TEST (•••)	23
3.6.1 Lead Resistance Compensation	23
3.7 RESISTANCE MEASUREMENT	24
3.8 DIODE TEST 	24
3.9 CURRENT MEASUREMENT (A)	25
3.9.1 AC Measurement	25
3.9.2 DC Measurement	26

3.10	STARTING CURRENT OR OVERCURRENT (TRUE INRUSH®) MEASUREMENT	27
3.11	FREQUENCY MEASUREMENT (Hz).....	27
3.11.1	Frequency Measurement (V)	27
3.11.2	Frequency Measurement (A)	28
3.12	TEMPERATURE MEASUREMENT.....	29
3.12.1	Measurement without External Sensor	29
3.12.2	Measurement with External Sensor	29
3.13	ADAPTER FUNCTION MEASUREMENT	30
4	SPECIFICATIONS	31
4.1	REFERENCE CONDITIONS.....	31
4.2	SPECIFICATIONS UNDER THE REFERENCE CONDITIONS.....	31
4.2.1	DC Voltage Measurement.....	31
4.2.2	AC Voltage Measurement	32
4.2.3	DC Current Measurement	32
4.2.4	AC Current Measurement	33
4.2.5	True Inrush® Measurement.....	33
4.2.6	Continuity Measurement	33
4.2.7	Resistance Measurement	34
4.2.8	Diode test.....	34
4.2.9	Frequency Measurements	34
4.2.10	Temperature Measurement.....	35
4.2.11	Adapter Function Measurement.....	36
4.3	ENVIRONMENTAL CONDITIONS	37
4.4	MECHANICAL SPECIFICATIONS	37
4.5	POWER SUPPLY.....	37
4.6	COMPLIANCE WITH INTERNATIONAL STANDARDS.....	37
4.7	ENVIRONMENTAL VARIATIONS	38
5	MAINTENANCE.....	39
5.1	WARNING	39
5.2	CLEANING	39
5.3	REPLACEMENT OF THE BATTERY.....	39
6	REPAIR AND CALIBRATION	40
7	TECHNICAL AND SALES ASSISTANCE.....	40
8	LIMITED WARRANTY	41
9	WARRANTY REPAIRS	41

Thank you for purchasing a **Model 203 Clamp-on Meter**.

For best results from your instrument and for your safety, read the enclosed operating instructions carefully and comply with the precautions for use. These products must be only used by qualified and trained users.

Meanings of the symbols used on the device

	CAUTION - Risk of Danger! Indicates a WARNING and that the operator must refer to the user manual for instructions before operating the instrument in all cases where this symbol is marked.
	Risk of electric shock. The voltage at the parts marked with this symbol may be dangerous.
	Refers to a type A current sensor. This symbol signifies that application around and removal from HAZARDOUS LIVE conductors is permitted.
	9V battery
	The CE marking indicates compliance with European directives
	Double insulation or reinforced insulation
	In the European Union, this product is subject to a separate collection system for recycling electrical and electronic components In accordance with directive WEEE 2002/96/EC
	AC – Alternating current
	AC and DC – Alternating and direct current
	Ground/Earth

PRECAUTIONS FOR USE

This device complies with safety standards IEC-61010-1 and 61010-2-032 for voltages of 1000V in category IV at an altitude of less than 2000m, indoors, with a degree of pollution not exceeding 2. These safety instructions are intended to ensure the safety of persons and proper operation of the device.

- The operator and/or the responsible authority must carefully read and clearly understand the various precautions to be taken in use.
- If this instrument is used other than as specified, the protection it provides may be compromised, thereby endangering you.
- Do not use the instrument in an explosive atmosphere or in the presence of flammable gases or fumes.
- Do not use the instrument on networks of which the voltage or category exceeds those mentioned.
- Do not exceed the rated maximum voltages and currents between terminals or with respect to earth.
- Do not use the instrument if it appears to be damaged, incomplete, or not properly closed.
- Before each use, check the condition of the insulation on the leads, housing, and accessories. Any element of which the insulation is deteriorated (even partially) must be set aside for repair or scrapped.
- Use leads and accessories rated for voltages and categories at least equal to those of the instrument. If not, an accessory of a lower category lowers the category of the combined Clamp + accessory to that of the accessory.
- Observe the environmental conditions of use.
- Do not modify the instrument and only use factory replacement parts. Repairs and adjustments must be done by approved qualified personnel.
- Replace the batteries as soon as the  symbol appears on the display of the unit. Disconnect all leads before opening the battery compartment cover.
- Use personal protective equipment when conditions require.
- Keep your hands away from the unused terminals of the instrument.
- When handling the test probes, alligator clips, and clamp ammeters, keep your fingers behind the physical guard.
- As a safety measure, and to avoid repeated overloads on the inputs of the device, configuration operations should only be performed when the device is disconnected from all dangerous voltages.

MEASUREMENT CATEGORIES

Definitions of the measurement categories :

CAT IV: Circuits supplying the low-voltage installation of the building.
Example: power lines, meters, and protection devices.

CAT III: Power supply circuits in the installation of the building.
Example: distribution panel, circuit-breakers, fixed industrial machines or devices.

CAT II: Circuits directly connected to the low-voltage installation.
Example: power supply to household electrical appliances and portable tools.

RECEIVING YOUR SHIPMENT

Upon receiving your shipment, make sure that the contents are consistent with the packing list. Notify your distributor of any missing items. If the equipment appears to be damaged, file a claim immediately with the carrier and notify your distributor at once, giving a detailed description of any damage. Save the damaged packing container to substantiate your claim.

ORDERING INFORMATION

Clamp-on Meter Model 203 **Cat. #2139.12**
Includes set of 2, 5 ft. (1.5m) needle tip color-coded leads with 4mm right angle plug, K-thermocouple with 4mm integrated adapter, soft carrying case, 1x9V battery and user manual.

Replacement Parts:

Soft Carrying Case **Cat. #2118.65**
K-thermocouple with 4mm integrated adapter **Cat. #2139.71**
Set of 2, 5 ft. (1.5m) Needle Tip Color-coded (Rd/Bk) Leads w/4mm Right-angle Plug (600V CAT IV w/shield on Needle Tip, 1000V CAT II w/o shield) **Cat. #2154.74**

Accessories:

Set of 2, Color-coded (Rd/Bk) Leads, Test Probes & Alligator **Cat #2152.05**

1 PRESENTATION

The Clamp-on Meter Model 203 is a 6000-count professional electrical measuring instrument that combines the following functions:

- Current measurement
- Measurement of InRush current / overcurrent (True InRush®)
- Voltage measurement
- Frequency measurement
- Continuity test with buzzer
- Resistance measurement
- Diode test
- Temperature measurement
- Adapter function (for use with external transducers/measurement devices)



Item	Designation	See §
1	Jaws with centering marks (see connection principles)	3.5 to 3.12
2	Physical Guard	-
3	Rotary Function Switch	1.1
4	Function Buttons	2
5	Backlit Display	1.3
6	Input Terminals	1.4
7	Trigger	-

Figure 1: Clamp-on Meter Model 203

1.1 ROTARY SWITCH

The rotary switch has six positions. To access the V_{\sim} , Ω , A_{\sim} , °C/°F , Adp_{\sim} functions, set the switch to the desired function. The functions are described in the table below.

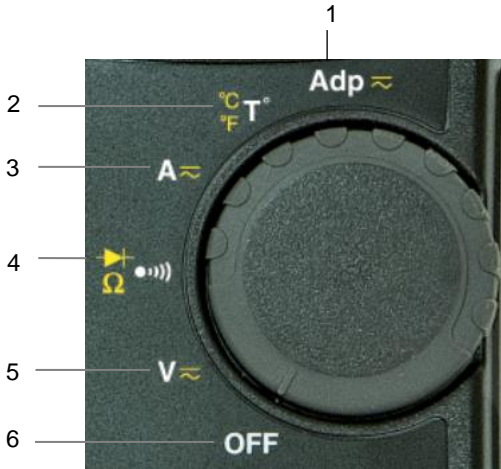

Figure 2: Function Rotary Switch

Item	Function	See §
1	Adapter function	3.13
2	Temperature measurement (°C/°F)	3.12
3	AC, DC current measurement (A)	3.9
4	Continuity test $\bullet\text{---}\text{ }$)	3.6
	Resistance measurement Ω	3.7
	Diode test $\blacktriangleright\text{---}\text{ }$	3.8
5	AC, DC voltage measurement (V)	3.5
6	OFF mode – Turns the clamp-on meter off	3.3

1.2 FUNCTION BUTTONS

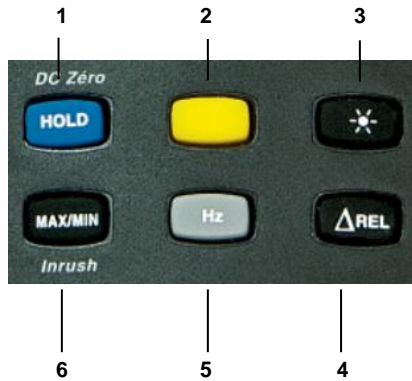

Figure 3: Function Buttons

Item	Function	See §
1	Holds the last value on the display Zero correction A_{DC} Lead resistance compensation in the continuity and ohmmeter functions	2.1 3.9.2 3.6.1
2	Selects the type of measurement and configuration functions (AC, DC)	2.2
3	Enables/disables display backlighting	2.3
4	Activation of Δ REL mode – Displays differential and relative values	2.6
5	Performs Frequency measurements (Hz)	2.5
6	Enables/disables the MAX/MIN mode Enables/disables the True InRush® mode	2.4

1.3 DISPLAY

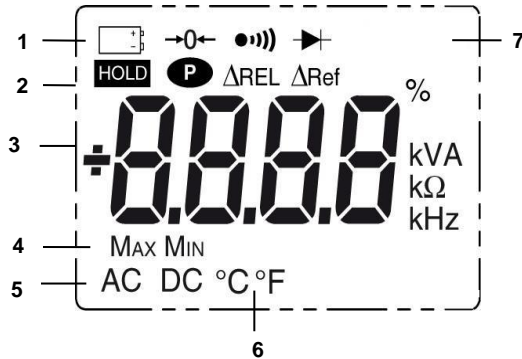



Figure 4: Display

Item	Function	See §
1	Low battery indication	5.3
2	Mode selection display	2
3	Active measurement value and unit display	3.5 to 3.12
4	Display of the MAX/MIN modes	2.4
5	Type of measurement (AC or DC)	2.2
6	Temperature unit display	3.4.4
7	Selected resistance measurement display	1.1

1.3.1 Display Symbols

Symbol	Designation
AC	Alternating current or voltage
DC	Direct current or voltage
ΔREL	Relative value, with respect to a reference
ΔRef	Reference value
HOLD	Storage of the values and display hold
Max	Maximum DC or RMS value
Min	Minimum DC or RMS value
V	Volt
Hz	Hertz

A	Ampere
°C/°F	Temperature unit Celsius or Fahrenheit
%	Percentage
Ω	Ohm
m	Milli- prefix
k	Kilo- prefix
→0←	Lead resistance compensation
•)))	Continuity test
▶ 	Diode test
P	Auto Power Off disabled
	Low battery indicator

1.3.2 Measurement Capacity Exceeded (OL)

The **OL** (Over Load) symbol is displayed when the display capacity is exceeded.

1.4 TERMINALS

The terminals are used as follows:





Figure 5: Terminals

Item	Function
1	COM (black) Input Terminal Jack
2	+ Positive (red) Input Terminal Jack

2 BUTTONS

The buttons respond differently to short, long, and sustained presses.

The ,  and  keys provide additional functions as well as the detection and acquisition of parameters complementary to the basic measurements.









- Each of these buttons can be used independently of the others or in conjunction with each other. This makes navigation simple and intuitive when reviewing measurement results.
- It is possible, for example, to either look up in turn sequence the MAX, MIN, etc. values of the RMS voltage alone, then display relative values in parallel



In this section, the  icon represents the possible positions of the switch for the button's functionality.

2.1 BUTTON

This button is used to:

- Store and look up the last values acquired specific to each function (V, A, Ω, T°, Adp) according to the specific modes previously activated (MAX/MIN, Hz, ΔREL). The present display is then maintained while the detection and acquisition of new values continues.
- Perform automatic lead resistance compensation (see § 3.6.1).
- Perform automatic zero correction in ADC (see § 3.9.2).

Successive presses on 		Function
	    	First press: Holds the display of the last value displayed Second press: Returns to normal display mode (the value of each new measurement is displayed)
long (> 2 sec)	ADC	Performs automatic zero correction (see 3.9.2) NOTE: This mode operates if the MAX/MIN or HOLD modes (short press) are first de activated
long (> 2 sec)		Performs automatic lead resistance compensation (see 3.6.1)











See § 2.4.2 and § 2.5.2 for the  button functionality in combination with the  and  buttons.

2.2 (YELLOW) BUTTON (SECOND FUNCTION)







This button is used to select the type of measurement (AC, DC) and the second functions marked in yellow next to the relevant positions of the switch.

It can also be used to modify the default values in the configuration mode (see § 3.4).

NOTE: This button is invalid in the MAX/MIN, HOLD and Δ REL modes.

Successive presses on 		Function
	  	- Selects AC or DC. Depending on your choice, the screen displays AC or DC
		- Cycles through the continuity ) , Ω and diode test  modes and returns to the continuity test 
		- Selects °C or °F as the temperature unit

2.3 BUTTON

Successive presses on 		Function
	    	- Enables/disables the backlighting of the display











NOTE: The backlighting is automatically disabled at the end of 2 minutes.

2.4 BUTTON

2.4.1 Normal Mode









This button activates the detection of the MAX and MIN values of the measurements made. Max and Min are the extreme mean values in DC and the extreme RMS values in AC.

NOTE: In this mode, the Auto Power Off function of the device is automatically disabled. The  symbol is displayed on the screen.

Successive presses on 		Function
short	   	<p>First press: Activates detection of the MAX/MIN values</p> <p>Second press: Displays the MAX or MIN value successively</p> <p>Third press: Returns to the display of the present measurement without exiting from the mode (the values already detected are not erased)</p> <p>NOTE: The MAX and MIN symbols are both displayed, but only the symbol of the measurement selected blinks.</p> <p>Example: If MIN has been selected, MIN blinks and MAX is lit steadily.</p>
long (> 2 sec)	    	<p>- Exits the MAX/MIN mode. The values previously recorded are then erased.</p> <p>NOTE: If the HOLD function is activated, it is not possible to exit from the MAX/MIN mode. The HOLD function must first be disabled first.</p>

NOTE : ΔREL function can be used with the functions of the MAX/MIN mode.





2.4.2 The MAX/MIN Mode + Activation of the HOLD Mode

Successive presses on 		Function
short	    	<ul style="list-style-type: none"> - Displays the MAX/MIN values detected before the  button was pressed. - When the  button is pressed, the last value is held on the display.

NOTE: The HOLD function does not interrupt the acquisition of new MAX, MIN values

2.4.3 Access to the True Inrush® Mode (set switch to)

This button allows measurement of the True Inrush® current (starting current, or overcurrent in steady-state operation) for AC or DC current.





Successive presses on 		Function
long (>2 sec)		<ul style="list-style-type: none"> - First press: Enters the True InRush® mode - "Inrh" is displayed for 3s (the backlighting blinks) - The triggering threshold is displayed for 5s (the backlighting is steady) - "-----" is displayed and the "A" symbol flashes (backlighting turns off) - After detection and acquisition, the InRush current measurement is displayed, after the calculations stage "-- ----" (backlighting off) <p>NOTE: The A symbol flashes to indicate "surveillance" of the signal.</p> <ul style="list-style-type: none"> - Second press: Exits the True InRush® mode (returns to simple current measurement).
short (<2 sec) Note: A short press is functional only if a True InRush value has been detected.		<ul style="list-style-type: none"> - Displays the PEAK+ value of the current - Displays the PEAK- value of the current - Displays the RMS True InRush® current <p>NOTE: The A, AC and PEAK values flash during this sequence.</p>

2.5 BUTTON





This button is used to display the frequency measurements of a signal.

NOTE: This button is not functional in the DC mode.

2.5.1 Normal Mode













Successive presses on 		Function
	 	Displays: <ul style="list-style-type: none">- The frequency of the signal measured- The present voltage (V) or current (A) measurement

2.5.2 The Hz Function + Activation of the HOLD Mode

Successive presses on 		Function
	 	<ul style="list-style-type: none">- Holds the last frequency reading- Successively displays the last held frequency, then the voltage or the current- NOTE: Pressing the  button a second time returns to realtime measurement updates.

2.6 BUTTON

This button is used to display and store the reference value in the unit of magnitude measured, or to display the differential and relative values, in %.

Successive presses on 		Function
short	    	Enters the ΔREL mode, to store, then display the reference value. The ΔRef symbol is displayed. <ul style="list-style-type: none"> - Displays the differential value: (current value – reference (Δ)) The ΔREL symbol is displayed. - Displays the relative value in % (current value – reference (Δ)) The ΔREL and % symbols are displayed. - Displays the reference. The ΔRef symbol is displayed - Displays the current value. The ΔRef symbol blinks.
long (>2 sec)	    	<ul style="list-style-type: none"> - Exits from the ΔREL mode

NOTE: The “Relative mode ΔREL” function can also be used with the functions of the MAX/MIN mode.

3 USE

3.1 INSTALLING THE BATTERY

Insert the battery supplied with the device as follows:

1. Using a screwdriver, unscrew the battery compartment cover (item 1) from the back of the housing.
2. Insert the 9V battery supplied (item 2), observing polarities.
3. Close the battery compartment cover and screw it onto the housing.

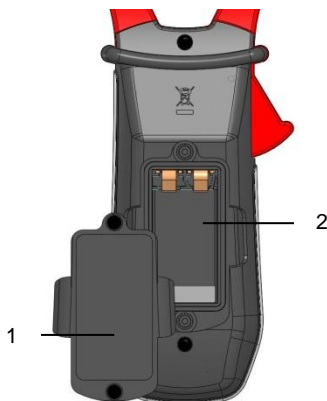

Figure 6 : Battery Compartment

3.2 TURNING THE CLAMP-ON METER ON

- With the rotary switch set in the OFF position, turn the switch to the desired function. The display lights (all symbols) for a few seconds (see §1.3), then the screen of the function chosen is displayed.
- The clamp-on meter is now ready to make measurements.

3.3 TURNING THE CLAMP-ON METER OFF

The clamp-on meter can be turned off in two ways:







- Manually - Turn the switch to the OFF position.
- Automatically - After ten minutes with no activity, the instrument will turn OFF. Thirty (30) seconds before the device is switched off, an audible signal sounds intermittently. To re-activate the device, press any button or turn the rotary switch.

3.4 CONFIGURATION

As a safety measure, and to avoid repeated overloads on the inputs of the device, configuration operations should only be performed when the device is disconnected from all dangerous voltages.

3.4.1 Configuring the Maximum Resistance for Continuity





To configure the maximum resistance allowed for a continuity:

1. With the switch in the OFF position, hold the  (yellow) button down while turning the switch to  until the "full screen" display ends and a beep is emitted. The display will indicate the value below which the buzzer is activated and the  symbol is displayed. The value stored by default is 40Ω. The possible values range between 1Ω and 999Ω.
2. To change the threshold, press the  (yellow) button. The right-hand digit flashes; each press on the  (yellow) button increments it. To shift to the next digit, apply a long press (>2s) to the  (yellow) button.

When the desired value is displayed, turn the switch to another setting. The detection threshold chosen is stored and a double beep is emitted.

3.4.2 Auto Power OFF

The Auto Power OFF feature is enabled by default. To disable it, perform the following:



1. In the OFF position, hold the  button down while turning the switch to  until the "full screen" display ends and a beep is emitted. The  symbol is displayed.
2. When the  button is released, the device is in the voltmeter function in the normal mode.
3. To return to Auto Power OFF, turn the clamp-on meter OFF and then back ON again.

3.4.3 Configuring the Current Threshold for True InRush® Measurement

To configure the triggering current threshold of the True InRush® measurement:

1. In the OFF position, hold the  button down while turning the switch to  until the "full screen" display ends and a beep is emitted. The display will indicate the percentage overshoot to apply to the measured current to determine the measurement triggering threshold.

The value stored by default is 10%, representing 110% of the established current measured. The possible values are 5%, 10%, 20%, 50%, 70%, 100%, 150%, and 200%.



2. To change the threshold, press the  (yellow) button. The value flashes; each press on the  (yellow) button displays the next value. To record the chosen threshold, apply a long press (>2s) on the  (yellow) button. A confirmation beep is emitted.

When the desired value is displayed, turn the switch to another setting. The chosen threshold is stored and a double beep is emitted.

NOTE: The starting (InRush) current measurement triggering threshold is fixed at 1% of the least sensitive range. This value is 1% of 99.99A or 1A. This threshold is not adjustable.

3.4.4 Changing the Default Temperature Unit

To change the measurement unit, °C or °F:





1. In the OFF position, hold the  (yellow) button down while turning the switch to  until the "full screen" display ends and a beep is emitted. The display will indicate the currently assigned unit (°C or °F). The default unit is °C.
2. Pressing the  (yellow) button toggles between °C and °F.

When the desired unit is displayed, turn the switch to another setting. The unit chosen is stored and a double beep is emitted.

NOTE: Pressing the  (yellow) button during an active temperature measurement will toggle between °C and °F.

3.4.5 Configuring the Adapter Function Scale Factor



To configure the Adapter function scale factor :

1. From the OFF position, hold the  (yellow) button down while turning the switch to  until the "full screen" display ends and a beep is emitted, to enter configuration mode. The display unit indicates the stored scale factor value. The default stored value is 10. The possible values are, in order: 1, 10k, 100k, 100m, 10m, 1m, 100, 10. (see §3.13)
2. To change the value of the scale factor, press the  (yellow) button. The currently active scale factor is displayed. Each press of the  (yellow) button displays the next value in the list above.

Once the scale factor displayed has been chosen, turn the switch to another position. The value chosen is stored and a double beep is emitted.

3.4.6 Default Configuration

To reset the clamp-on meter to its default parameters (factory configuration):

1. In the OFF position, hold the  (yellow) button down while turning the switch to **A~**, until the "full screen" display ends and a beep is emitted. The "rSt" symbol is displayed.
2. After 2 s, the clamp-on meter emits a double beep, then all of the digital symbols of the screen are displayed until the  (yellow) button is released. The default parameters are then restored:
 - Continuity detection threshold = 40Ω
 - True InRush triggering threshold = 10%
 - Temperature measurement unit = $^{\circ}\text{C}$
 - Adapter function scale factor = 1

3.5 VOLTAGE MEASUREMENT (V)

To measure voltage, proceed as follows:

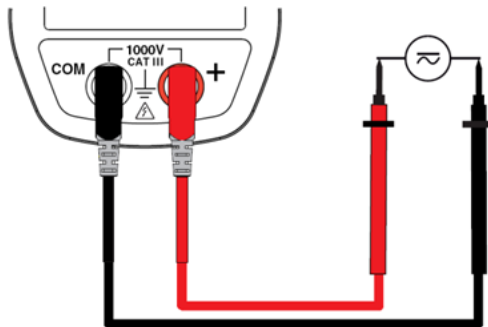

1. Set the switch to **V~**.
2. Connect the black lead to the **COM** terminal and the red lead to the **+** terminal.
3. Connect the test probes or the alligator clips to the circuit to be measured. The device selects AC or DC automatically according to which measured value is larger. The AC or DC symbol displays blinking in auto detect mode.
4. To select AC or DC manually, press the  (yellow) button to toggle between them. The symbol corresponding to the choice will then display.



The measured value is displayed on the screen.

3.6 CONTINUITY TEST

Warning: Before performing the test, make sure that the circuit is off and all capacitors have been discharged.

1. Set the switch to ; the  symbol is displayed.
2. Connect the black lead to the **COM** terminal and the red lead to the **"+"** terminal.
3. Connect the test probes or the alligator clips to the circuit or component to be measured.

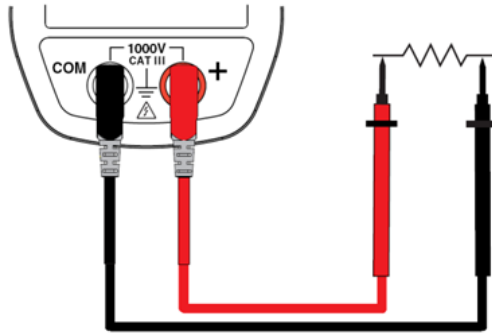



An audible signal is emitted if there is continuity (resistance value is below the maximum threshold, see § 3.4.1) and the measured value is displayed on the screen.

3.6.1 Lead Resistance Compensation

Warning: Before the compensation is executed, the MAX/MIN and HOLD modes must be de-activated.



To perform automatic compensation of the test lead resistance, proceed as follows:

1. Short-circuit the leads connected to the meter.
2. Hold the  button down until the display unit indicates the lowest value. The device measures the resistance of the leads.
3. Release the  button. The correction and the $\rightarrow 0 \leftarrow$ symbol are displayed. The value displayed is stored.

NOTE: The correction value is stored only if it is $\leq 2\Omega$. Above 2Ω , the value displayed blinks and is not stored.

3.7 RESISTANCE MEASUREMENT Ω

Warning: Before making a resistance measurement, make sure that the circuit is off and all capacitors have been discharged.

1. Set the switch to  and press the  (yellow) button. The Ω symbol is displayed.
2. Connect the black lead to the **COM** terminal and the red lead to the "+" terminal.
3. Connect the test probes or the alligator clips to the circuit or component to be measured.

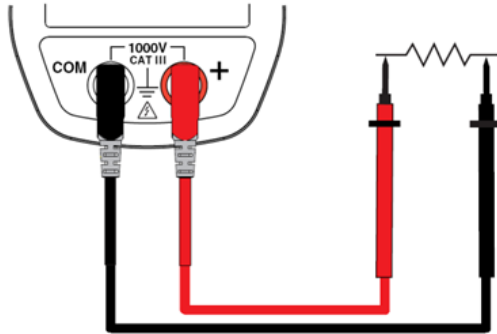



The measured value is displayed on the screen.

NOTE: To measure low resistance values, first perform lead resistance compensation (see § 3.6.1).

3.8 DIODE TEST $\rightarrow|+$

Warning: Before performing the diode test, make sure that the circuit is off and all capacitors have been discharged.

1. Set the switch to  and press the  (yellow) button twice. The $\rightarrow|+$ symbol is displayed.
2. Connect the black lead to the **COM** terminal and the red lead to the "+" terminal.
3. Connect the test probes or the alligator clips to the component to be tested.

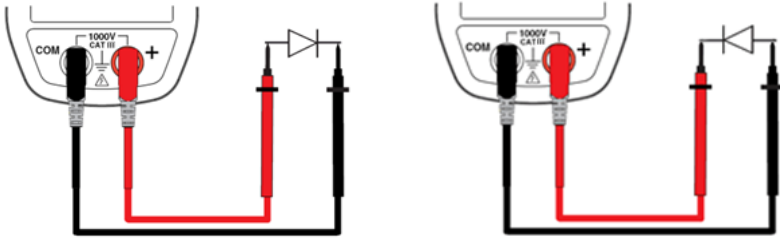

The measured value is displayed on the screen.

- Reverse the leads on the diode and repeat the test.

3.9 CURRENT MEASUREMENT (A)



The jaws are opened by pressing the trigger on the body of the meter. The arrow on the jaws of the clamp-on meter (see the diagram below) should point in the presumed direction of current flow, from the generator to the load. Make sure that the jaws have closed correctly after clamping around the conductor.

NOTE: The measurement results are optimal when the conductor is centered in the jaws (aligned with the centering marks).

The device selects AC or DC automatically according to which measured value is larger. The AC or DC symbol displays blinking in auto detect mode.

3.9.1 AC Measurement

For an AC current measurement, proceed as follows:

- Set the switch to  and select AC by pressing the  (yellow button). The AC symbol is displayed.
- Clamp the jaws around the conductor to be measured. The device selects AC or DC automatically.

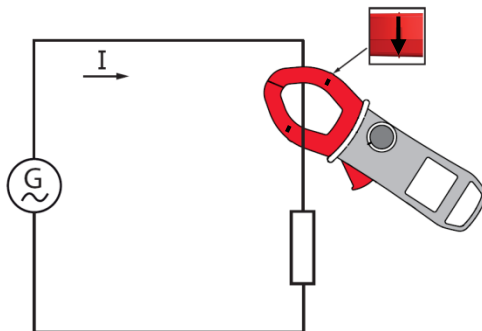

The measured value is displayed on the screen.

3.9.2 DC Measurement

Set the switch to **A \approx** and select DC if the display does not indicate "0"; the DC zero must be corrected first.

Step 1: Correction of DC Zero

Important: The clamp must not be closed on the conductor during the DC zero correction. Hold the clamp in the same position during the whole procedure so that the correction value will be exact.

Press the **HOLD** button until the device emits a double beep and displays a value near "0". The correction value is stored until the clamp is powered down.

NOTE: The correction is effected only if the value displayed is $< \pm 10A$, otherwise the value displayed blinks and is not stored. The clamp must be recalibrated (see § 5.3).

Step 2 : Make a Measurement

1. The switch is set to **A \approx** . Select DC by pressing the **■** (yellow) button until the desired choice is reached.
2. Clamp the jaws around the conductor to be measured.

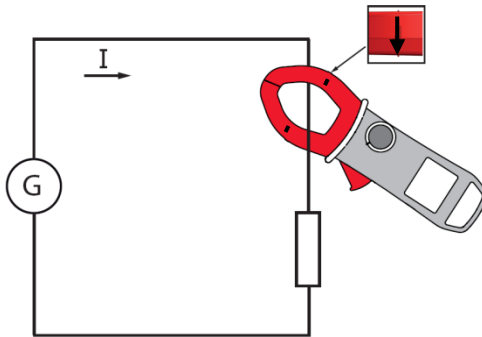

The measured value is displayed on the screen.

3.10 STARTING CURRENT OR OVERCURRENT (True InRush®) MEASUREMENT

To measure a starting current or overcurrent, proceed as follows:

1. Set the switch to **A** , correct the DC zero (see §3.9.2), then clamp the jaws around the conductor to be measured.
2. Perform a long press on the **MAX/MIN** button. The **InRh** symbol is displayed, along with the triggering threshold. The clamp then awaits detection of the True InRush® current. "-----" is displayed and the A symbol flashes.
3. After detection and acquisition for 100 ms, the RMS value of the True InRush® current is displayed. Pressing the **MAX/MIN** button will display the PEAK+/PEAK- values subsequently.
4. A long press on the **MAX/MIN** button or a change of function on the rotary switch will exit the True InRush® mode.



NOTE: The triggering threshold in A is 10A if the initial current is zero (starting of installation). For an established current (overload in an installation) see §3.4.3.

3.11 FREQUENCY MEASUREMENT (HZ)

The frequency measurement is available in V and A for AC measurements. The measurement is based on a count of zero crossings (positive-going edges).

3.11.1 Frequency Measurement (V)

To measure the frequency in voltage, proceed as follows:

1. Set the switch to **V**  and press the **Hz** button. The **Hz** symbol is displayed.
2. Select AC by pressing the  (yellow) button until the desired choice is reached.
3. Connect the black lead to the **COM** terminal and the red lead to the **+** terminal.
4. Connect the test probes or the alligator clips to the circuit to be measured.

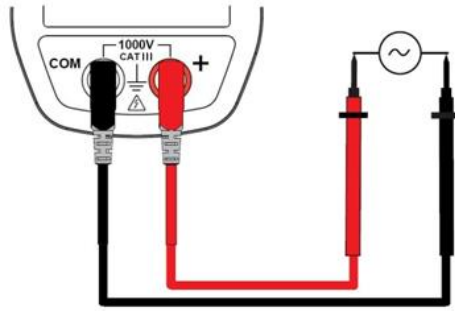

The measured value is displayed on the screen.

3.11.2 Frequency Measurement (A)

1. Set the switch to **A** and press the **Hz** button. The **Hz** symbol is displayed.
2. Select AC by pressing the **AC** (yellow) button until desired choice is reached.
3. Clamp the jaws around the conductor to be measured.

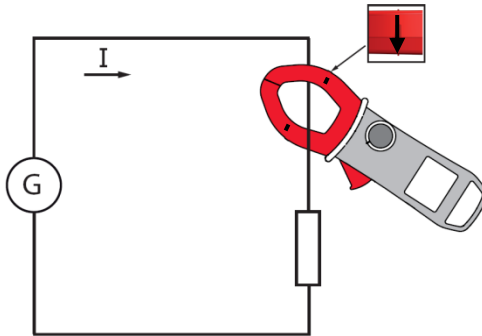

The measured value is displayed on the screen.

3.12 TEMPERATURE MEASUREMENT

3.12.1 Measurement without External Sensor

1. Set the switch to .

The temperature (blinking) displayed is the internal temperature of the device. It will be equal to the ambient temperature after a sufficiently long thermal stabilization time (at least one hour).

3.12.2 Measurement with External Sensor

The device measures the temperature using a K-thermocouple.

1. Connect the K-thermocouple to the **COM** and “+” input terminals of the device observing the red and black banana plug polarity.
2. Set the switch to .
3. Place the K-thermocouple on the element or environment to be measured. It must not be at a dangerous voltage.

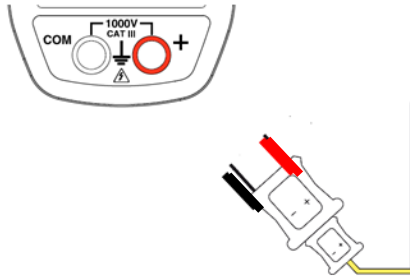

The temperature will be displayed on the screen.

To change the unit to either °F or °C, press the  (yellow) button.

NOTE:

- If the external sensor is defective, the temperature displayed blinks.
- If there are large variations of the initial temperature environment of the meter and the measurement environment, the measurement must be preceded by a stabilization time.

3.13 ADAPTER FUNCTION MEASUREMENT

This function makes it possible to connect any adapter or sensor that converts a measured electrical or physical quantity into a voltage (either DC or AC). A direct, immediate reading is obtained without applying a conversion factor.

The measurement mode, AC or DC (the default), must be chosen manually using the yellow button.

The scale factor for the adapter or sensor must be chosen in advance in the instrument's set-up (§3.4.5). The table below indicates the various adapter/sensor sensitivities that allow a direct reading once the scale factor has been chosen.

Adapter/Sensor Sensitivity	Scale Factor to be Programmed
10 mV/kX (0.01 mV/X)	10 k
100 mV/kX (0.1 mV/X)	100 k
1 mV/X	1
10 mV/X	10
100 mV/X	100
1000 mV/X (1 mV/mX)	1 m
10 mV/mX	10 m
100 mV/mX	100 m

NOTE: The value represented as (X) is valid for any quantity: humidity (%RH), illumination (lux), speed (m/s), flow, (GPM) etc.

1. Connect the black lead to the **COM** terminal and the red lead to the "+" terminal.
2. Set the switch to **Adp** .
3. Select the AC or DC mode.
4. Connect the adapter according to its directions for use.

4 SPECIFICATIONS

4.1 REFERENCE CONDITIONS

Quantities of Influence	Reference Conditions
Temperature:	23°C ±2°C
Relative humidity:	45% to 75%
Supply voltage:	9.0V ±0.5V
Frequency range of the applied signal:	45 to 65Hz
Sine wave:	pure
Peak factor of the applied alternating signal:	√2
Position of the conductor in the clamp:	centered
Adjacent conductors:	none
Alternating magnetic field:	none
Electric field:	none

4.2 SPECIFICATIONS UNDER THE REFERENCE CONDITIONS

Accuracy is expressed in ± (x% of the reading (R) + y counts (ct)).

4.2.1 DC Voltage Measurement

Measurement range	0.00 to 59.99V	60.0 to 599.9V	600 to 1000V ⁽¹⁾
Specified measurement range	0 to 100% of the measurement range		
Accuracy	from 0.00V to 5.99V ±(1% R + 10cts) from 6.00V to 59.99V ±(1% R + 3cts)	±(1% R + 3cts)	
Resolution	0.01V	0.1V	1V
Input impedance	10MΩ		

Note (1) The display indicates "+OL" above + 2000V and "-OL" below - 2000V, in REL mode. The "-" and "+" signs are managed. Above 1000V, a repetitive beep indicates that the voltage being measured is greater than the safety voltage for which the device is guaranteed. The display indicates "OL."

4.2.2 AC Voltage Measurement

Measurement range	0.15 to 59.99V	60.0 to 599.9V	600 to 1000V RMS 1400V peak (1)
Specified measurement range (2)	0 to 100% of the measurement range		
Accuracy	0.15 to 5.99V $\pm (1\% R + 10\text{cts})$ 6.00 to 59.99V $\pm (1\% R + 3\text{cts})$	$\pm (1\% R + 3\text{cts})$	
Resolution	0.01V	0.1V	1V
Input impedance	10M Ω		

Note (1) Above 1000V (RMS), a repetitive beep indicates that the voltage being measured is greater than the safety voltage for which the device is guaranteed. The display indicates "OL".
- Bandwidth in AC = 3 kHz

Note (2) Any value between zero and the min. threshold of the measurement range (0.15V) is forced to show "----" on the display.

Specific Specifications in MAX/MIN mode (from 10Hz to 1kHz, and from 0.30V in AC):

- Accuracy: add 1% R to the values of the table above.
- Capture of the extreme: approximately 100ms.

4.2.3 DC Current Measurement

Measurement Range (2)	0.00 to 59.99A	60.0 to 599.9A	600 to 900A (1)
Specified measurement range	0 to 100% of the measurement range		
Accuracy (2) (zero corrected)	$\pm (1\% R + 10\text{cts})$	$\pm (1\% R + 3\text{cts})$	
Resolution	0.01A	0.1A	1A

Note (1) The display indicates "+OL" above 1800A and "-OL" below -1800A in REL mode. The "-" and "+" signs are displayed.

Note (2) The residual current at zero depends on the remanence. It can be corrected by the "DC zero" function of the HOLD button.

4.2.4 AC Current Measurement

Measurement Range	0.25 to 59.99A	60.0 to 599.9A	600A ⁽¹⁾
Specified Measurement Range ⁽²⁾	0 to 100% of the measurement range		
Accuracy	± (1% R + 10cts)	± (1% R + 3cts)	
Resolution	0.01A	0.1A	1A

Note (1) Bandwidth in AC = 3kHz

Note (2) In AC, any value between zero and the min. threshold of the measurement range (0.25A) is forced to show "----" on the display. Residual current at zero <250mA.

Specific Specifications in MAX/MIN mode (from 10Hz to 1kHz, and from 0.30A in AC):

- Accuracy (with zero corrected): add 1% R to the values of the table above.
- Capture of the extreme: approximately 100ms.

4.2.5 True Inrush[®] Measurement

Measurement Range	6 to 600AAC	6 to 900Adc
Specified Measurement Range	0 to 100% of the measurement range	
Accuracy	± (5% R + 5cts)	
Resolution	1A	

Specific Specifications in PEAK mode in True InRush[®] (from 10Hz to 1kHz):

- Accuracy: add ± (1.5% R + 0.5A) to the values in the table above.
- PEAK capture time: 1ms min. to 1.5ms max.

4.2.6 Continuity Measurement

Measurement Range	0.0 to 599.9Ω
Open-circuit Voltage	≤ 3.6V
Measurement Current	550μA
Accuracy	± (1% R + 5cts)
Buzzer Triggering Threshold	Adjustable from 1 to 599Ω (40Ω is the default)

4.2.7 Resistance Measurement

Measurement Range ⁽¹⁾	0.0 to 599.9Ω	600 to 5999Ω	6.00 to 59.99kΩ
Specified Measurement Range	1 to 100% of the measurement range	0 to 100% of the measurement range	
Accuracy	± (1% R +5cts)		
Resolution	0.1Ω	1Ω	10Ω
Open-circuit Voltage	≤ 3.6V		
Measurement Current	550μA	100μA	10μA

Note (1) Above the maximum display value, the display unit indicates "OL".
The "-" and "+" signs are not managed.

Specific Specifications in MAX/MIN mode:

- Accuracy: add 1% R to the values of the table above.
- Capture of the extreme: approximately 100ms.

4.2.8 Diode test

Measurement Range	0.000 to 3.199VDC
Specified Measurement Range	1 to 100% of the measurement range
Accuracy	± (1% R + 10cts)
Resolution	0.001V
Measurement Current	0.55mA
Indication: junction reversed or open-circuit	"OL" is displayed when the measured voltage >3.199V

 **Note:** The "-" sign is disabled for the diode test function.

4.2.9 Frequency Measurements

4.2.9.1 Voltage

Measurement Range ⁽¹⁾	5.0 to 599.9Hz	600 to 5999Hz	6.00 to 19.99kHz
Specified Measurement Range	1 to 100% of the measurement range	0 to 100% of the measurement range	
Accuracy	± (0.4% R + 1ct)		
Resolution	0.1Hz	1Hz	10Hz

4.2.9.2 Current

Measurement Range (1)	5.0 to 599.9Hz	600 to 2999Hz
Specified Measurement Range	1 to 100% of the measurement range	0 to 100% of the measurement range
Accuracy	$\pm (0.4\% R + 1ct)$	
Resolution	0.1Hz	1Hz

Note (1) In MAX/MIN mode, the operating range is limited to 1kHz.
If the level of the signal is too low (<10% of the range, or $V < 3V$ or $I < 3A$) or if the frequency is less than 5Hz, the device cannot determine the frequency and displays "----".

Specific Specifications in MAX/MIN mode (from 10Hz to 1kHz):

- Accuracy: add 1% R to the values of the table above.
- Capture of the extreme: approximately 100ms.

4.2.10 Temperature Measurement

Function	External temperature	
Type of Sensor	K-thermocouple	
Measurement Range	-60.0° to +599.9°C -76.0° to +1111.8°F	+600° to +1200°C +1112° to +2192°F
Specified Measurement Range	1 to 100% of the measurement range	0 to 100% of the measurement range
Accuracy (1)	1% R $\pm 3^\circ\text{C}$ 1% R $\pm 5.4^\circ\text{F}$	1% R $\pm 3^\circ\text{C}$ 1% R $\pm 5.4^\circ\text{F}$
Resolution	0.1°C 0.1°F	1°C 1°F

Note (1) The stated external temperature measurement accuracy does not take the accuracy of the K-thermocouple into account.

Note 2 Use of the thermal time constant (0.7min/°C):
If there is a sudden variation of the temperature of the clamp, by 10°C for example, the clamp will be at 99% (cnst = 5) of the final temperature after 0.7min/°C x 10°C x 5 = 35 min (the time constant of the external sensor must be added to this value).

Specific Specifications in MAX/MIN mode:

- Accuracy: add 1% R to the values of the table above.
- Capture of the extreme: approximately 100ms.

4.2.11 Adapter Function Measurement

4.2.11.1 In DC mode

Measurement Range (1)	0.0 to 599.9mV	0.60 to 5.999V
Specified Measurement Range (2)	0 to 100% of the measurement range	
Accuracy	1% R \pm 3cts	
Resolution	0.1mV	1mV
Input Impedance	10M Ω	

4.2.11.2 In AC mode

Measurement Range (1)	5.0 to 599.9mV	0.600 to 5.999V
Specified Measurement Range (2)	1 to 100% of the measurement range	0 to 100% of the measurement range
Accuracy	5.0 to 59.9mV \pm (1% R + 10cts) 60.0 to 599.9mV \pm (1% R +3cts)	1% R \pm 3cts
Resolution	0.1mV	1mV
Input Impedance	10M Ω	

Note (1) The basic display is 6000 counts. The position of the decimal count and the display of multiples (m and k) depend on the programming of the scale factor.

- In DC, the display indicates "+OL" above +5999 counts and "-OL" below -5999 counts. The "-" and "+" signs are managed (polarity).
- In AC, the display indicates "OL" above 5999 counts.

Note (2) - The max. bandwidth is 1kHz.

Specific specifications in MAX/MIN mode (from 10Hz to 1kHz):

- Accuracy: add 1% R to the values of the table above.
- Capture of the extreme: approximately 100ms.

4.3 ENVIRONMENTAL CONDITIONS

Conditions	Operating	Storage
Temperature	-4° to +131°F (-20° to +55°C)	-40° to +158°F (-40° to +70°C)
Relative Humidity (RH)	≤90% up to 131°F (55°C)	≤90% up to 158°F (70°C)

4.4 MECHANICAL SPECIFICATIONS

Housing	Rigid polycarbonate shell with molded elastomer covering
Jaws	Polycarbonate Opening: 1.34" (34mm) Clamping diameter: 1.34" (34mm)
Screen	LCD display unit Blue backlighting Dimension: 1.1 x 1.7" (28 x 43.5mm)
Dimension	8.7 x 3.1 x 1.65" (222 x 78 x 42mm)
Weight	12 oz (340g) with the battery

4.5 POWER SUPPLY

Battery	1x9V LF22
Battery life	>130 hours (without backlighting)
Auto Power Off	After 10 minutes with no switch and/or button activity

4.6 COMPLIANCE WITH INTERNATIONAL STANDARDS

Electric Safety	Compliant with standards IEC-61010-1, IEC-61010-2-30, and IEC-61010-2-32: 1000V CAT III or 600V CAT IV
Electromagnetic Compatibility	Compliant with standard EN-61326-1 Classification: residential environment
Mechanical strength	Free fall: 2m (in accordance with standard IEC-68-2-32)
Level of Protection	Housing: IP40 (per standard IEC-60529) Jaws: IP40

4.7 ENVIRONMENTAL VARIATIONS

Condition of Influence	Range of Influence	Measurement Influenced	Influence	
			Typical	MAX
Temperature	-4° to +131°F (-20° to +55°C)	VAC VDC A T°C Ω  Hz	- 0.1% R/10°C 1% R/10°C (0.2% R + 1°C)/10°C 0.1% R/10°C + 2ct	0.1% R/10°C 0.5% R/10°C + 2ct 1.5% R/10°C + 2ct (0.3% R + 2°C)/10°C 0.1% R/10°C + 3ct
Humidity	10 to 90% RH	V A	0.1% R	0.1% R + 1ct
Frequency	10Hz to 1kHz 1kHz to 3kHz 10Hz to 400Hz 400Hz to 3kHz	V A	1% R 8% R 1% R 4% R	1% R + 1ct 9% R + 1ct 1% R + 1ct 5% R + 1ct
Position of the conductor in the jaws (f≤400Hz)	Any position on the internal perimeter of the jaws	A	2% R	4% R + 1ct
Adjacent conductor carrying a current of 150ADC or RMS	Conductor touching the external perimeter of the jaws	A	42dB	35dB
Conductor enclosed by the clamp	0 to 500ARMS	V	< 1ct	1ct
Application of a voltage on the clamp	0 to 1000VDC or RMS	A	< 1ct	3% R + 1ct
Peak factor	1.4 to 3.5, limited to 1500A peak 1400V peak	A (AC) V (AC)	1% R 1% R	3% R + 1ct

5 MAINTENANCE

5.1 WARNING

- Remove the test leads on any input before opening the case.
- Do not operate the clamp-on meter without a battery case cover.
- To avoid electrical shock, do not attempt to perform any servicing unless you are qualified to do so.
- To avoid electrical shock and/or damage to the instrument, do not get water or other foreign agents into the probe.

5.2 CLEANING

- Disconnect everything connected to the device and set the switch to OFF.
- Use a soft cloth moistened with soapy water. Rinse with a damp cloth and dry quickly using a dry cloth or forced air.
- Dry completely before putting back into use.

5.3 REPLACEMENT OF THE BATTERY

The  symbol indicates that the battery is low. When this symbol appears on the display unit, the battery must be replaced. The measurements and specifications are no longer guaranteed.

To replace the battery, proceed as follows:

1. Disconnect the measurement leads from the input terminals.
2. Set the switch to OFF.
3. Using a screwdriver, unscrew the battery compartment cover from the back of the housing (see §3.1).
4. Remove the used battery and replace it with a 9V LF22 battery, observing the polarities.
5. Close the battery compartment cover and screw it onto the housing.

6 REPAIR AND CALIBRATION

To ensure that your instrument meets factory specifications, we recommend that it be submitted to our factory Service Center at one-year intervals for recalibration, or as required by other standards or internal procedures.

For instrument repair and calibration:

You must contact our Service Center for a Customer Service Authorization number (CSA#). This will ensure that when your instrument arrives, it will be tracked and processed promptly. Please write the CSA# on the outside of the shipping container. If the instrument is returned for calibration, we need to know if you want a standard calibration, or a calibration traceable to N.I.S.T. (includes calibration certificate plus recorded calibration data).

Chauvin Arnoux[®], Inc. d.b.a. AEMC[®] Instruments
15 Faraday Drive
Dover, NH 03820 USA
Tel: (800) 945-2362 (Ext. 360)
(603) 749-6434 (Ext. 360)
Fax: (603) 742-2346 or (603) 749-6309
repair@aemc.com

(Or contact your authorized distributor)

Costs for repair, standard calibration, and calibration traceable to N.I.S.T. are available.

NOTE: All customers must obtain a CSA# before returning any instrument.

7 TECHNICAL AND SALES ASSISTANCE

If you are experiencing any technical problems, or require any assistance with the proper operation or application of your instrument, please call, mail, fax or e-mail our technical support hotline:

Chauvin Arnoux[®], Inc. d.b.a. AEMC[®] Instruments
200 Foxborough Boulevard
Foxborough, MA 02035, USA
Phone: (800) 343-1391
(508) 698-2115
Fax: (508) 698-2118
techsupport@aemc.com
www.aemc.com

NOTE: Do not ship instruments to our Foxborough, MA address.

8 LIMITED WARRANTY

The Model 203 is warranted to the owner for a period of three years from the date of original purchase against defects in manufacture. This limited warranty is given by AEMC® Instruments, not by the distributor from whom it was purchased. This warranty is void if the unit has been tampered with, abused or if the defect is related to service not performed by AEMC® Instruments.

Full warranty coverage and product registration is available on our website at www.aemc.com/warranty.html.

Please print the online Warranty Coverage Information for your records.

If a malfunction occurs within the three-year period, you may return the instrument to us for repair, provided we have your warranty registration information on file or a proof of purchase. AEMC® Instruments will, at its option, repair or replace the faulty material.

REGISTER ONLINE AT: www.aemc.com

9 WARRANTY REPAIRS

What you must do to return an Instrument for Warranty Repair:

First, request a Customer Service Authorization Number (CSA#) by phone or by fax from our Service Department (see address below), then return the instrument along with the signed CSA Form. Please write the CSA# on the outside of the shipping container. Return the instrument, postage or shipment pre-paid to:

Chauvin Arnoux®, Inc. d.b.a. AEMC® Instruments
15 Faraday Drive • Dover, NH 03820 USA
Tel: (800) 945-2362 (Ext. 360)
(603) 749-6434 (Ext. 360)
Fax: (603) 742-2346 or (603) 749-6309
repair@aemc.com

Caution: To protect yourself against in-transit loss, we recommend you insure your returned material.

NOTE: All customers must obtain a CSA# before returning any instrument.

NOTES:



Chauvin Arnoux[®], Inc. d.b.a AEMC[®] Instruments
15 Faraday Drive • Dover, NH 03820 USA
www.aemc.com

99-MAN 100420 v4 03/23

Quality Products Online at:

www.GlobalTestSupply.com

sales@GlobalTestSupply.com