

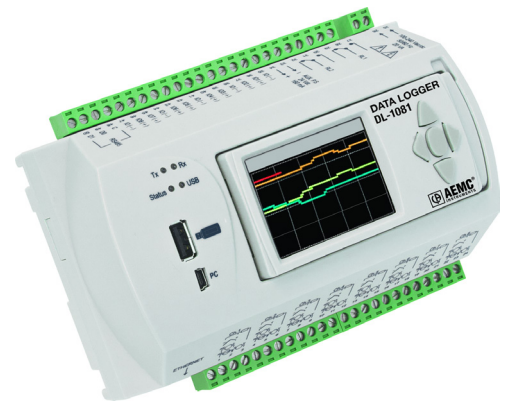

DATA LOGGER MODELS DL-1080/1081

USER MANUAL

V1.5x



INTRODUCTION.....	4
CONNECTIONS AND INSTALLATION.....	5
MECHANICAL INSTALLATION.....	5
ATTACHING AND DETACHING THE FRONT COVER	8
ATTACHING AND DETACHING THE DISPLAY	9
ELECTRICAL CONNECTIONS.....	9
SAFETY SUMMARY	9
RECOMMENDATIONS FOR INSTALLATION.....	10
POWER SUPPLY	11
DIGITAL I/O	11
RELAYS.....	11
RS485.....	11
AUXILIARY POWER SUPPLY FOR POWERING TRANSMITTERS	12
ANALOG INPUTS.....	13
CONNECTIVITY RESOURCES	14
FLAGS (LEDS).....	15
INSTALLING THE USB DRIVER	16
WINDOWS 7	16
DEFINITION AND SELECTION OF SERIAL PORT (COM) - WINDOWS.....	19
CONFIGURATION AND DATA DOWNLOAD SOFTWARE.....	20
CONFIGURATION	21
GENERAL CONFIGURATIONS	23
RS485 INTERFACE CONFIGURATION.....	24
ETHERNET INTERFACE CONFIGURATION	25
ETHERNET INTERFACE CONFIGURATION - TCP/IP	26
ETHERNET INTERFACE CONFIGURATION – FTP	27
ETHERNET INTERFACE CONFIGURATION - SMTP.....	28
ETHERNET INTERFACE CONFIGURATION - E-MAIL RECEIVERS.....	28
ETHERNET INTERFACE CONFIGURATION - SNMP	29
ETHERNET INTERFACE CONFIGURATION – HTTP	30
ETHERNET INTERFACE CONFIGURATION – MODBUS TCP	31
ANALOG CHANNELS CONFIGURATION.....	32
ANALOG CHANNELS CONFIGURATION – CUSTOM CALIBRATION.....	34
DIGITAL CHANNELS CONFIGURATION.....	35
REMOTE CHANNELS CONFIGURATION	37
VIRTUAL CHANNELS CONFIGURATION	40
ALARMS CONFIGURATION	41
LOG CONFIGURATION	45
DIAGNOSTICS.....	47
DOWNLOAD	50
DOWNLOAD DATA	51
DOWNLOAD MANAGER.....	54
USING THE STEP-BY-STEP (WIZARD)	54
NON STEP-BY-STEP	62
PREFERENCES.....	66
PASSWORD PROTECTION.....	66
COMMAND-LINE OPERATION	67
BATCH FILE	67
ACTION TYPE	67
CONNECTION MODE	67

EXPORT PARAMETERS	68
<i>DATA LOGGER OPERATION</i>	69
ANALOG INPUTS	69
DIGITAL INPUTS/OUTPUTS	70
COUNTING.....	70
OUTPUT RELAYS.....	71
RS485 INTERFACE	71
AUXILIARY RS485.....	71
REMOTE CHANNELS.....	71
VIRTUAL CHANNELS.....	72
USB INTERFACE	73
USB DEVICE	73
USB HOST.....	74
ETHERNET INTERFACE	74
MODBUS-TCP.....	74
SENDING E-MAILS - SMTP	75
WEB PAGES - HTTP.....	75
UNCHANGABLE PAGES	75
CUSTOM PAGES	77
MARKERS	77
FILE TRANSFER - FTP	79
NETWORK MANAGEMENT - SNMP	79
DATA LOGGING AND DOWNLOAD.....	81
ALARMS.....	83
<i>DATA COMMUNICATION</i>	85
<i>DISPLAY (HUMAN-MACHINE INTERFACE)</i>	86
“FAVORITES” SCREEN	88
“CHART” SCREEN.....	88
“CHANNEL LIST” SCREEN.....	88
“ALARMS” SCREEN	88
“STATUS” SCREEN	89
“CONFIGURATION” SCREEN	90
<i>EQUIPMENT SOFTWARE/FIRMWARE UPDATE</i>	91
<i>CLOCK BATTERY REPLACEMENT</i>	92
<i>SPECIFICATIONS</i>	94
REPAIR AND CALIBRATION.....	96
TECHNICAL AND SALES ASSISTANCE.....	96
LIMITED WARRANTY.....	97
WARRANTY REPAIRS	97

Statement of Compliance

Chauvin Arnoux®, Inc. d.b.a. AEMC® Instruments certifies that this instrument has been calibrated using standards and instruments traceable to international standards.

We guarantee that at the time of shipping your instrument has met its published specifications.

An NIST traceable certificate may be requested at the time of purchase, or obtained by returning the instrument to our repair and calibration facility, for a nominal charge.

The recommended calibration interval for this instrument is 12 months and begins on the date of receipt by the customer. For recalibration, please use our calibration services. Refer to our repair and calibration section at www.aemc.com.

Serial #: _____

Catalog #: 2134.61/2134.62

Model #: DL-1080/DL-1081

Please fill in the appropriate date as indicated:

Date Received: _____

Date Calibration Due: _____



Chauvin Arnoux®, Inc.
d.b.a AEMC® Instruments
www.aemc.com

INTRODUCTION

The **Data Logger Models DL-1080/1081**, hereafter, will be referred to in this document as **Data Logger**.

The **Data Logger** is a high-resolution and high-speed data acquisition and logging equipment for analog and digital signals. The result of an advanced technological development, the product is distinguished in diverse aspects, such as high-performance, high-connectivity and ease of configuration and operation. This technology is presented as the ideal solution for applications that require flexibility and functionality for diverse communication networks.

Its main features include:

- Analog inputs: 8
- Digital inputs/outputs: 8
- Relay outputs: 2
- 2 MB internal memory
- SD Card interface (up to 16 GB – not available in some models)
- RS485 interface
 - Main: Modbus RTU master and slave
 - Auxiliary (DB9 connector – not available in some models): Modbus RTU slave
- Ethernet services (not available in some models):
 - DHCP
 - HTTP (web page)
 - FTP (client and server)
 - SMTP (e-mails sending)
 - SNMP
 - Modbus TCP
- USB:
 - Host
 - Device
- DISPLAY (HMI - human-machine interface [DISPLAY] – optional)

There are four input channel types in the **Data Logger**: analog, digital, remote and virtual. Analog and digital channels are those acquired directly by **Data Logger** through their respective inputs. The remote channels are those acquired through Modbus RTU protocol, operating as master on its RS485 interface. Virtual channels are a special type of input channel where mathematical operations can be carried out, allowing the calculation of complex formulas from the measured information.

The analog input channels are configurable for reading voltage, current, thermocouples, Pt100 and Pt1000 signals. These inputs count on the precision of a 24 bit A/D converter with high acquisition speed, which can reach 1000 samples per second. The digital channels can be configured individually as inputs or outputs.

The Ethernet interface allows data download and data access of the inputs and outputs, through services that can be individually enabled and configured. Through a web browser (HTTP), one can visualize the data of the enabled channel, diagnostics and general information of the **Data Logger**. FTP client can be used for logging data downloads. **Data Logger** can identify up to 32 distinct alarm conditions, allowing the triggering of outputs, sending e-mails or SNMP traps whenever an alarm condition is detected. All the information relative to the variables, status and diagnostics of the **Data Logger** are available in Modbus registers that can be accessed through the Modbus TCP interface or the Modbus RTU interface available either through USB interface (device) or RS485 (when operating as slave).

The USB Interface *device* is used for connection to a computer for configuration, monitoring or download. Whereas the USB interface *host* is used for connection of a USB flash drive, for data downloading from the logging memory.

The data logging memory can be transferred by any of the interfaces to the configuration software, which allows the exportation for the most diverse data formats.

When the indication of the measured data from the process is necessary, an exclusive color graphical DISPLAY (Human-Machine Interface) can be attached or installed remotely (optional).

NOTE: The DISPLAY is also referred to as HMI in the software provided with the data logger.

CONNECTIONS AND INSTALLATION



When unpacking, **remove** the insulating film of the **Data Logger** battery, located below the chassis according to **Fig. 01**, before carrying through the electrical wiring and configuration.

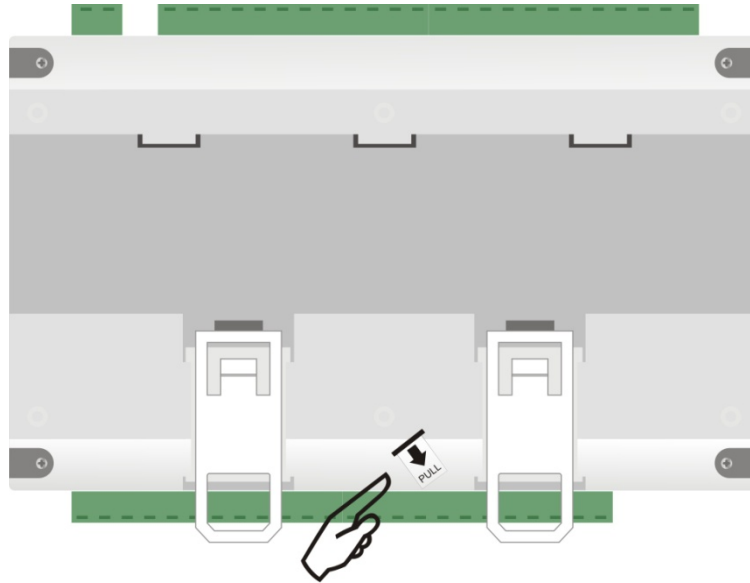

Fig. 01 – Insulating film of the battery

MECHANICAL INSTALLATION

Data Logger chassis can be installed on a 35 mm DIN rail.

For the installation on the rail, you must pull out the two clamps located right below the connections of the channels, taking care not to remove them, as per **Fig. 02**.

Note: If necessary, the connector may be removed for installation of DIN rail.

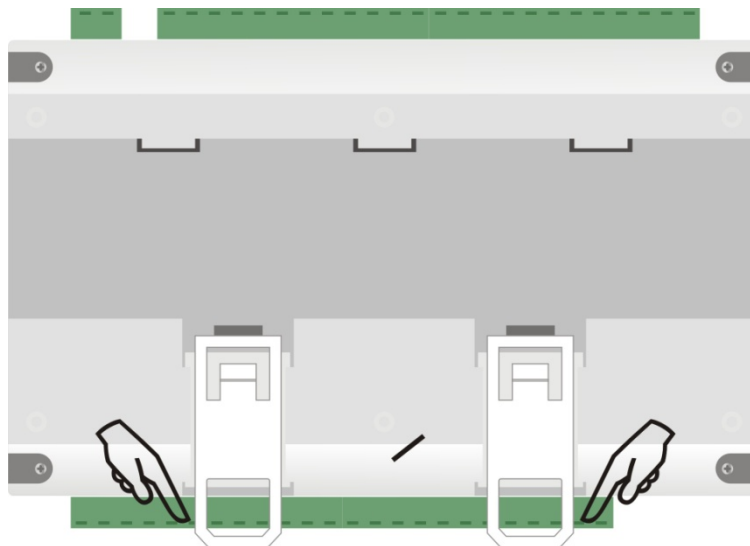

Fig. 02 - DIN rail installation

Afterwards, attach the **Data Logger** to the rail according to **Fig. 03**.

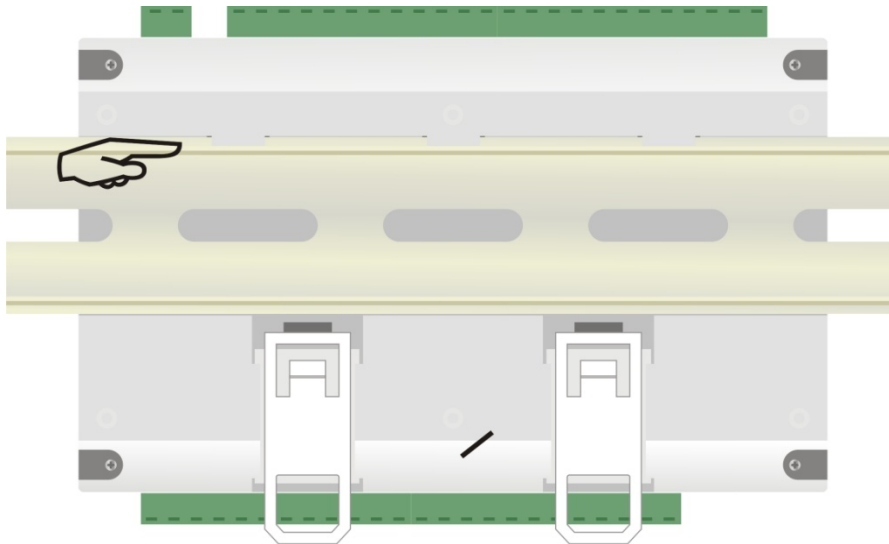

Fig. 03 - DIN rail installation

Finally, push the two clasps up until you hear a double-click to complete the installation, as shown in **Fig. 04**.

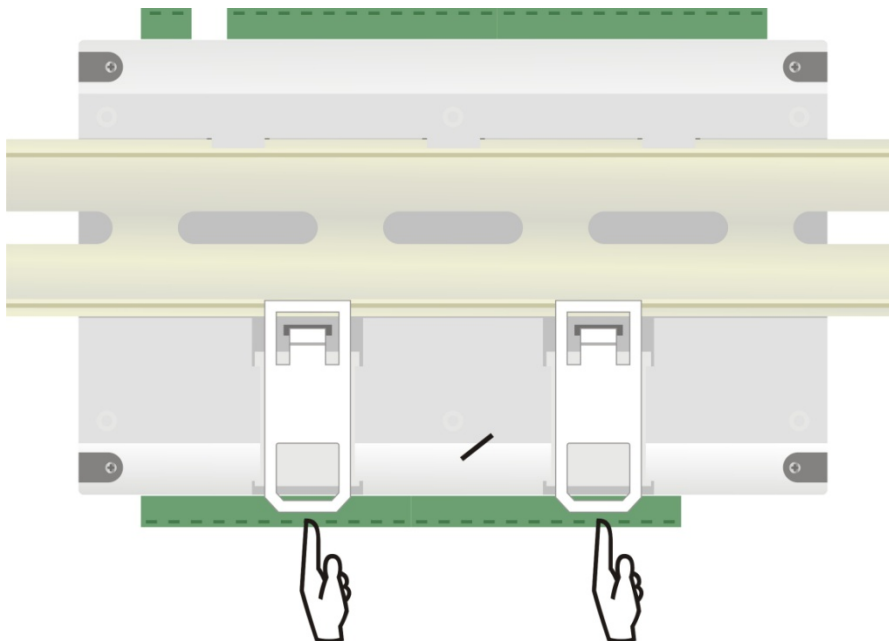

Fig. 04 - DIN rail installation

Dimensions:

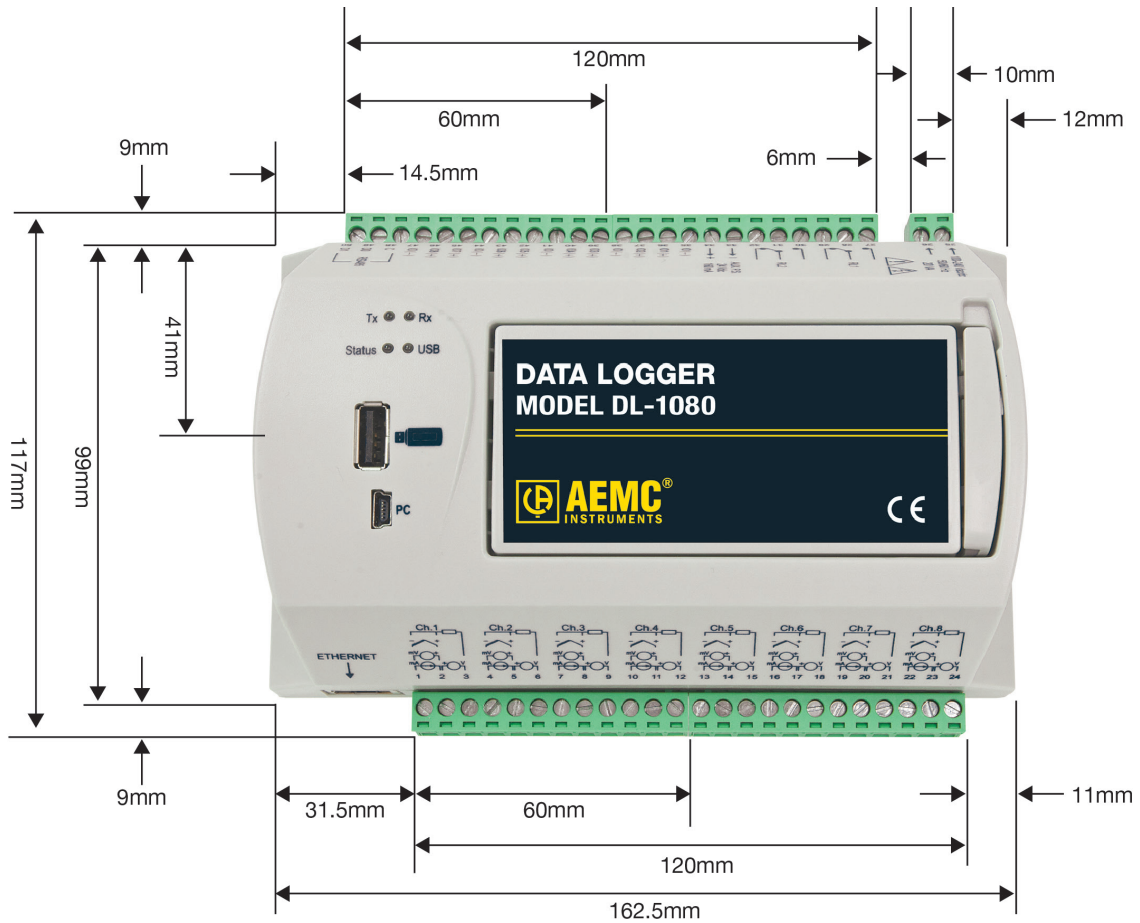

Fig. 05 – Dimensions without DISPLAY module

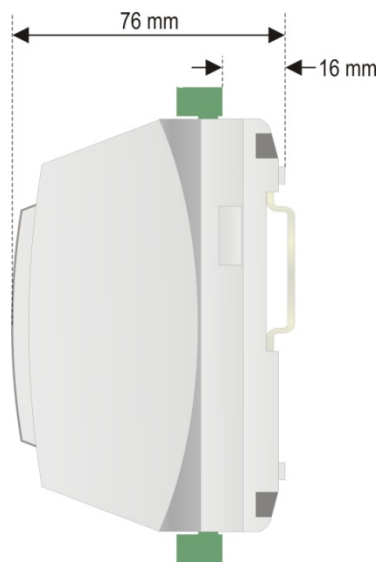
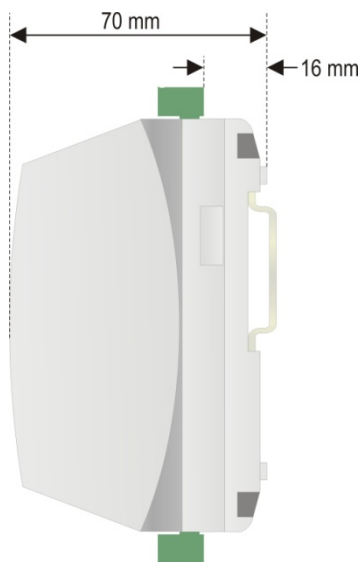

Fig. 06 – Dimensions of the side without DISPLAY module

Fig. 07 – Dimensions of the side with DISPLAY module

ATTACHING AND DETACHING THE FRONT COVER

NOTE: The DISPLAY is also referred to as **HMI** in the software provided with the data logger.

When detaching the front cover, pull the lever at the right side of the **Data Logger** up to the end.

When attaching it, insert the cover (left side first) and press its right side gently. After that, press the lever back into the chassis.



Fig. 08 – Attaching and detaching **Data Logger** front cover

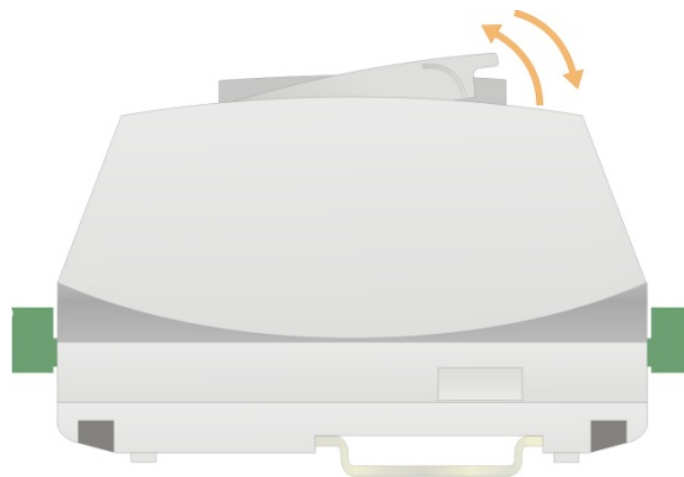

Fig. 09 – Attaching and detaching **Data Logger** front cover (side view)

ATTACHING AND DETACHING THE DISPLAY

NOTE: The DISPLAY is also referred to as **HMI** in the software provided with the data logger.

When detaching the DISPLAY, pull up the lever at the right side of the **Data Logger** up to the end.

When attaching it, insert the DISPLAY (left side first) and press its right side until DB9 connectors are firmly connected. After that, press the lever down into the chassis.



Fig. 10 – Attaching and detaching the **Data Logger** DISPLAY

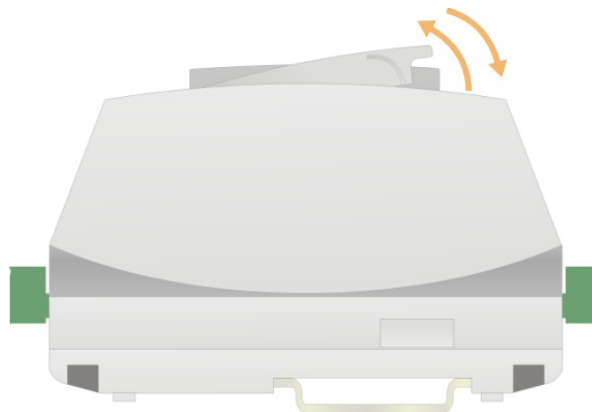





Fig. 11 – Attaching and detaching the **Data Logger** DISPLAY (side view)

ELECTRICAL CONNECTIONS

SAFETY SUMMARY

The symbols below are used on the equipment and throughout this document to draw the user’s attention to important operational and safety information.

			
<p>CAUTION or WARNING: Read complete instructions prior to installation and operation of the unit.</p>	<p>CAUTION or WARNING: Electrical Shock Hazard</p>	<p>DOUBLE INSULATION The Data Logger power supply is double insulated, represented by the above symbol printed on the equipment’s connection label.</p>	<p>POWER INPUT The Data Logger may be powered from either AC or DC power source.</p>

All safety related instructions that appear in the manual must be observed to ensure personal safety and to prevent

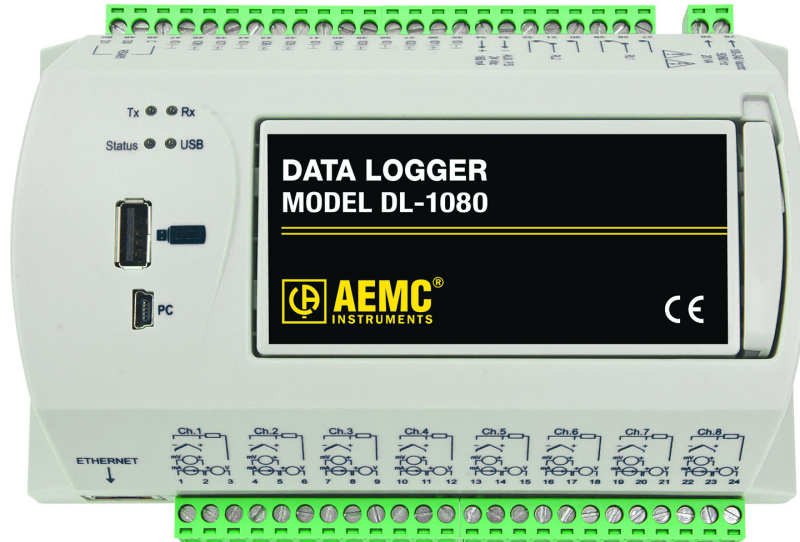

Fig. 12 - Data Logger front panel

The **Data Logger** has two rows of terminals. Among them are the following items: Ethernet, input connections, power supply, output relays, auxiliary power supply output, digital inputs and serial communication. This information is identified according to Fig. 13 and Fig. 14:

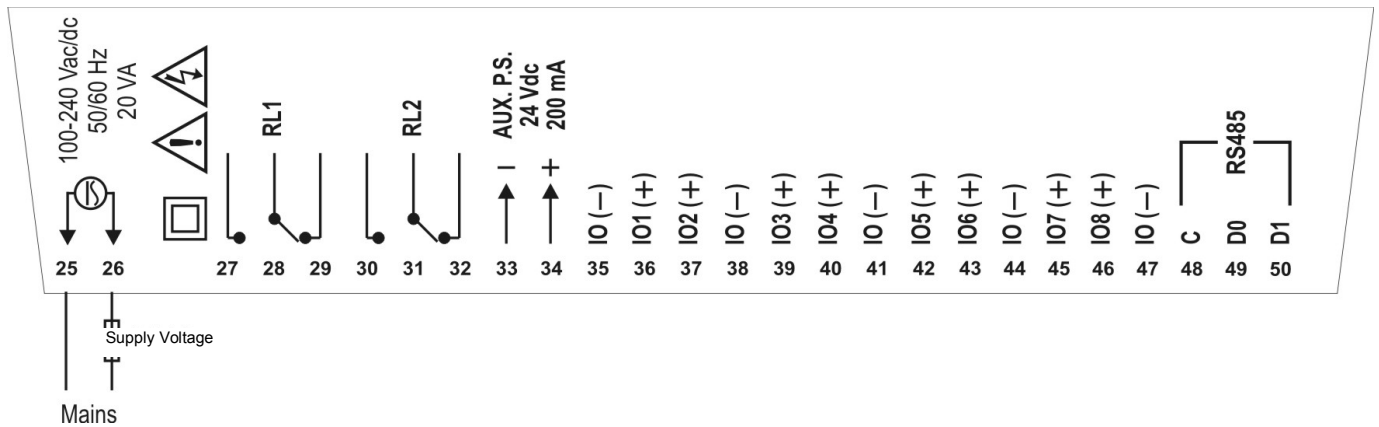

Fig. 13 - Upper side connections

- NOTES:**
- 1) An external protection device consisting of a 0.5A slow blow fuse (UL Listed) must be wired near to the **Data Logger**.
 - 2) A switch or circuit-breaker placed near to the **Data Logger** shall be used as the disconnecting device.

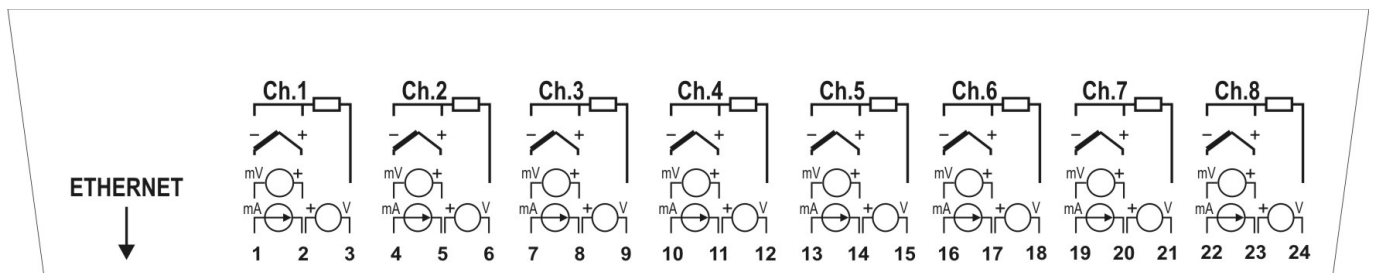

Fig. 14 - Lower side connections

RECOMMENDATIONS FOR INSTALLATION

- Input signal leads must be installed in grounded conduits and away from power or contactor wires.
- Instruments must be powered only by an exclusive power supply.
- Installing RC filters (47Ω and 100nF, serial) is strongly recommended at contactor coils or any other inductors.
- System failure should always be taken into account when designing a control panel to avoid irreversible damage to equipment or injury to people. The RL1 and RL2 output relays, used as alarms, do not warrant total protection.
- Wiring section: minimum gauge 0.14 mm².

POWER SUPPLY

The terminals 25 and 26 are used to supply power to the **Data Logger**.

DIGITAL I/O

There are eight I/O ports that can be individually configured as inputs or outputs. There is a terminal for the positive signal of each I/O, and a common negative terminal for all of them (there is no isolation between the channels).

• **Inputs:**

When configured as inputs, they may be connected to voltage outputs (please check the acceptable levels in the *Specifications* section), dry-contact outputs and NPN outputs. Care must be taken when connecting multiple outputs because there is no isolation between the **Data Logger** inputs.

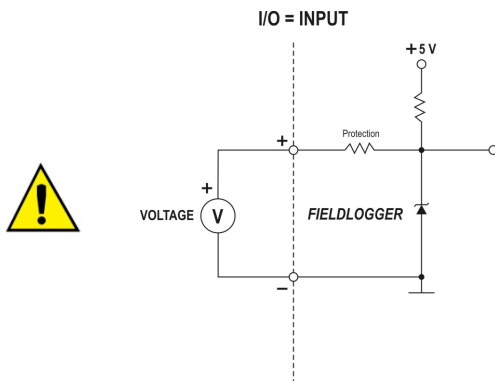

Fig. 15 - Voltage connection

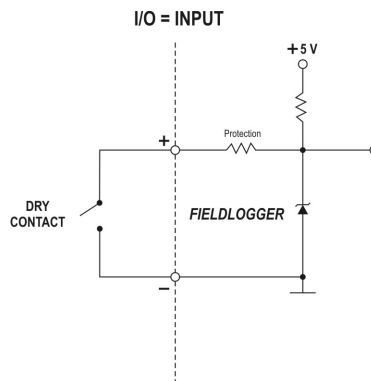

Fig. 16 - Dry-contact connection

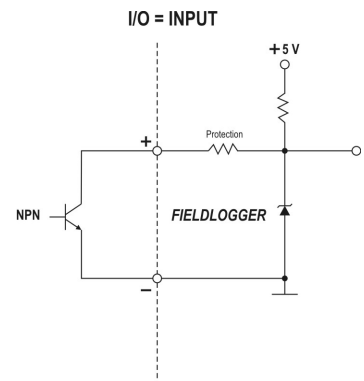

Fig. 17 - NPN Connection

• **Outputs:**

When configured as outputs, they can activate limited power loads (please check the *Specifications* section).

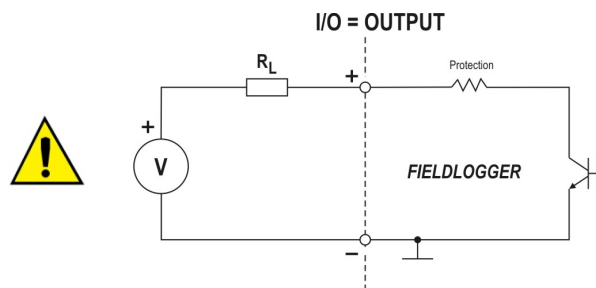

Fig. 18 - Connection of a load R_L to a digital output

RELAYS

The **Data Logger** has 2 relays that can be used in the activation of electrical loads (please check the *Specifications* section). For each relay, there is a common terminal, NC (normally closed) terminal and a NO (normally open) terminal. When deactivated, the relay common is in contact with the NC terminal. When activated, the common is in contact with the NO terminal.

RS485

The RS485 Interface of the **Data Logger** has terminals for the 3-wire communication, including the common. The connection in a Modbus network will depend if the device is configured to operate as a master or a slave.

- Master

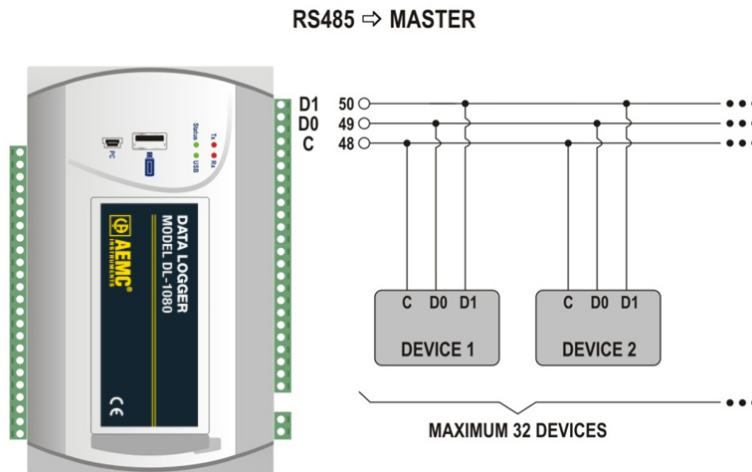

- Slave

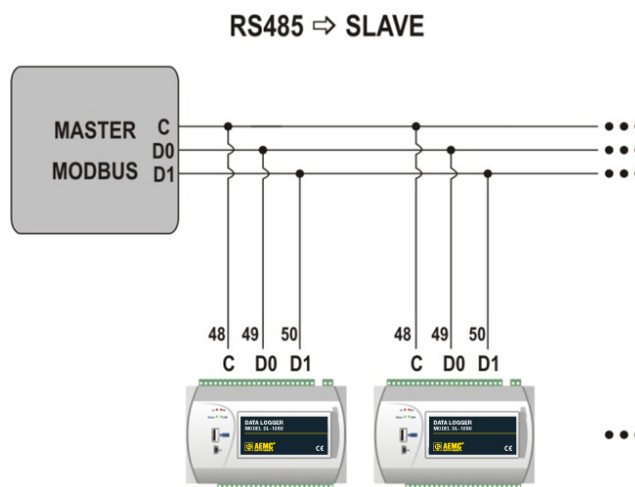

Fig. 19 – Master and Slave

AUXILIARY POWER SUPPLY FOR POWERING TRANSMITTERS

For non 24V transmitters, there is a built in 24Vdc power supply available in the **Data Logger**. This auxiliary power supply is electrically isolated from the other **Data Logger** terminals.

Below is the correct way to use the auxiliary power supply for powering 4-20mA transmitters (2-wire).

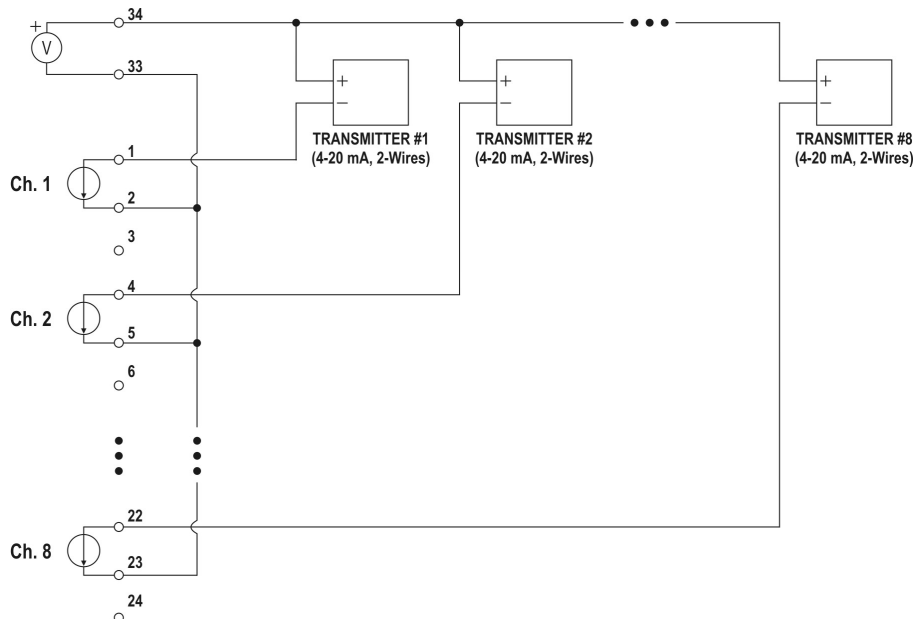
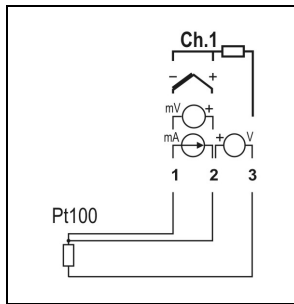

Fig. 20 – Auxiliary power supply powering 4-20mA (2-wire) transmitters

ANALOG INPUTS

Pt100/Pt1000 connection



The RTD connection for the channels is made to the terminals in accordance with the figure at the left. The 3-wire connection from the Pt100 sensing element to the **Data Logger** input guarantees the cancellation of the error caused by the lead resistance. All three wires must have the same gauge and length.
For the two-wire Pt100, interconnect terminals 1 and 2.

Thermocouple connection

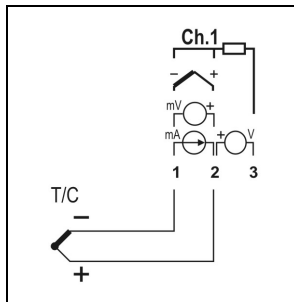

The Thermocouple connection for the channels is made to the terminals in accordance with the figure at the left. Please observe the correct connection polarity.
Cables used for connecting thermocouples must have the same thermoelectric characteristics as the thermocouple used (compensation cable or extension cable), and also must be connected with the correct polarity.
The non-use of compensation cables or the use with the incorrect polarity can cause significant measurement errors.

Voltage (mV) connection

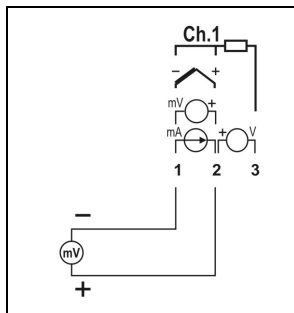

The millivolt connection for the channels is made to the terminals in accordance with the figure at the left. Please observe the correct polarity of the connection.

Voltage (V) connection

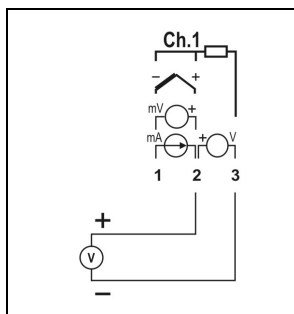

The voltage connection for the channels is made to the terminals in accordance with the figure at the left. Please observe the correct polarity of the connection.

Current (mA) connection

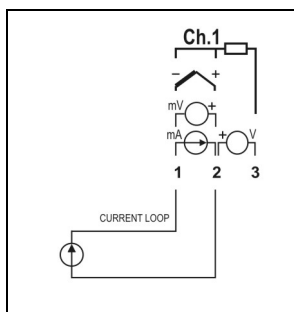

The milliamp connection for the channels is made to the terminals in accordance with the figure at the left. Please observe the correct polarity of the connection.

CONNECTIVITY RESOURCES

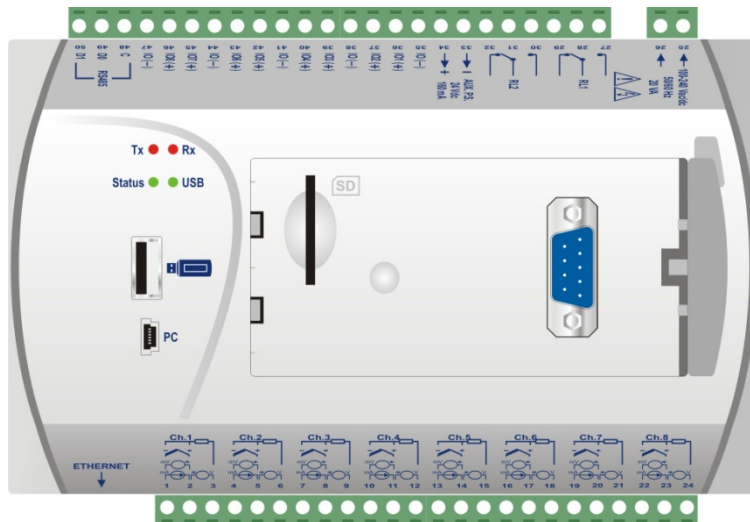
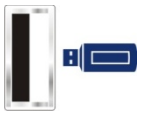



Fig. 21 - Data Logger connectivity resources

USB Connection

	<p>Interface used for a <i>USB drive</i> connection, for downloading data from the logger memory.</p>
---	---

PC Connection

	<p>Interface used for connection to a computer for configuration, monitoring or data download.</p>
---	--

SD card connection

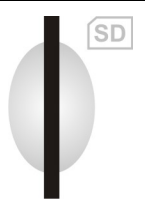
	<p>Interface used for SD card expansion. The data from the logger memory can be transferred by any of the interfaces to the configuration software, which allows exportation for a wide variety of data formats.</p>
---	--

Ethernet

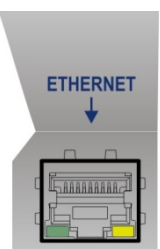
	<p>Interface used for Ethernet 10/100 communication. It is recommended to use a category 5 (or higher) cable in a RJ45 connector.</p> <p>The Ethernet connector on the Data Logger has two indicating LEDs: the green LED (on the left side) lights indicating the connection to the Ethernet network; the yellow LED (on the right side) flashes indicating that there is data traffic in the interface.</p>
---	--

DB9 connection for DISPLAY (Optional)

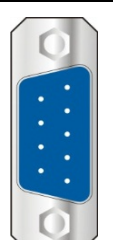
	<p>Connection for installation of the DISPLAY (Human–Machine Interface) on the Data Logger used for indicating measured signals and configuration. With firmware version 1.20 and higher, it can be used as a generic RS485/Modbus RTU (slave) port.</p>
---	---

FLAGS (LEDS)

Tx/Rx flags

	<p>These LEDs signal transmission and reception of data by the RS485/Modbus interface, regardless if it is configured to operate in master or slave mode.</p>
---	---

Status / USB flags

	<p>When connecting the equipment, both LEDs initially flash two times and then turn off until all the initialization has been completed.</p> <p>The Status flag remains ON in normal condition. When it is logging, flashes 2 times at 3 second intervals. In error conditions, this LED will be flashing 3 times at 8 second intervals.</p> <p>In the error cases, please check if the Data Logger clock has the correct date and time. If they are wrong, probably the clock battery has run down and needs to be replaced. If it is OK, try rebooting the machine by turning off its power supply and restarting it after 10 seconds. If the LED continues to indicate an error, there may be something wrong with your Data Logger requiring service.</p> <p>The USB flag remains ON only while a cable is connected to a USB device or while the USB flash drive is plugged into the USB host interface. The following exceptions are:</p> <ul style="list-style-type: none"> • Download errors via USB flash drive: flash drive with insufficient writing space, inability to write to the flash drive (write protected) or flash drive not compatible (sector different from 512 bytes, for example), the USB LED flashes while the error condition remains (typically, until the flash drive has been removed). Check the "USB Interface" section in the "Data Logger Operation" chapter for more details. • At the end of the download, if everything is correct, the USB flag remains ON until the flash drive has been removed from the equipment.
---	---

INSTALLING THE USB DRIVER

When installing the configuration software, the USB driver is automatically installed. If you need to install the driver without depending on the software, this can be done by following the procedure described below.

The following installation steps may vary from PC to PC, even for the same operating system version. The steps and screens that follow below are only for guidance purposes.

NOTE: The **Data Logger** may be referred to as the **FieldLogger** in some instances.

WINDOWS 7

1. Connect the **Data Logger** to a USB port on your computer. Windows will try to install a driver automatically and will not succeed, because the necessary driver is not in its standard library.
2. Click on "Start>Control Panel". Click on "System", then on the "Device Manager".
3. Locate the **Data Logger** (the icon with an exclamation mark next to it) and double-click on it.
4. Click on "Update Driver...".

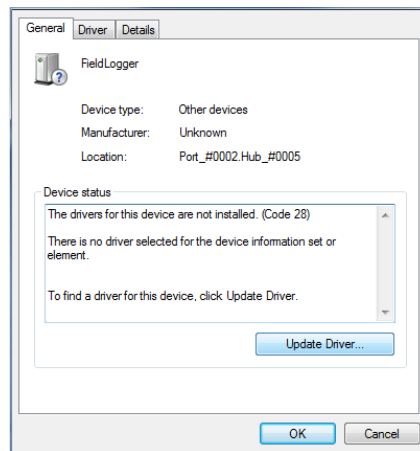

5. Ask to "Browse my computer for driver software".

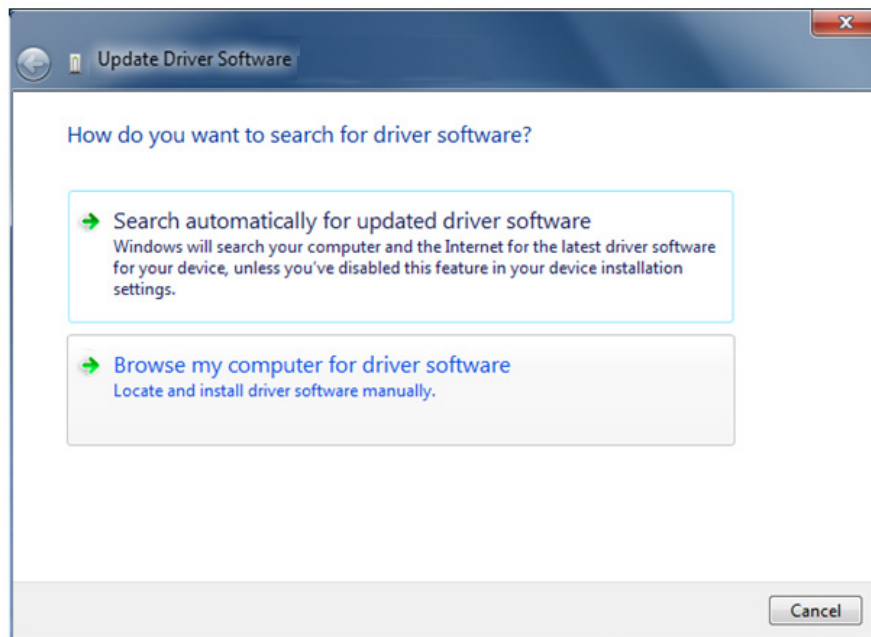

6. Enter the path for the folder where the drivers are located (the product CD or folder where you saved them when downloaded from the site).

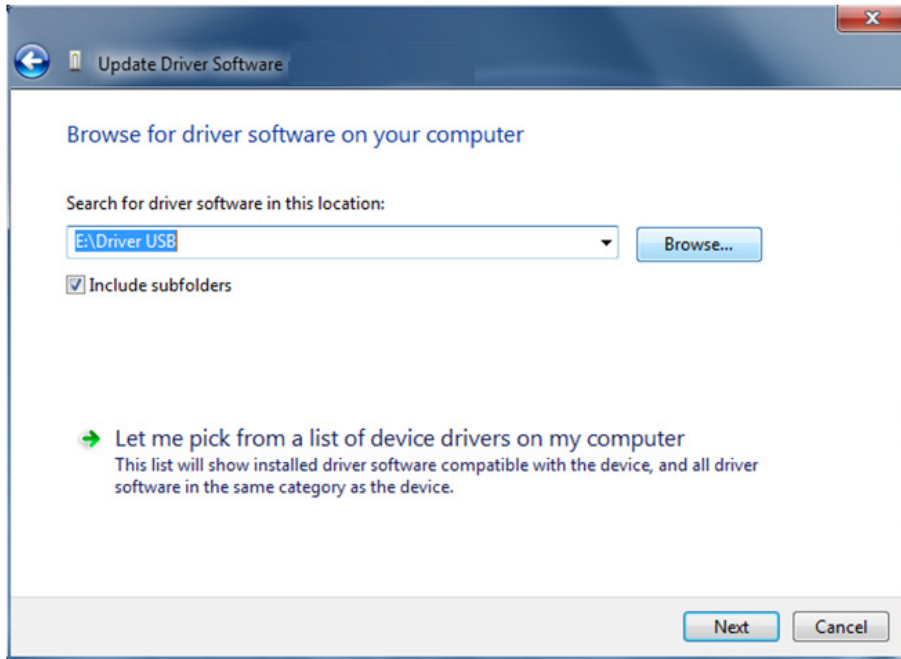

7. Wait for the installation to begin.

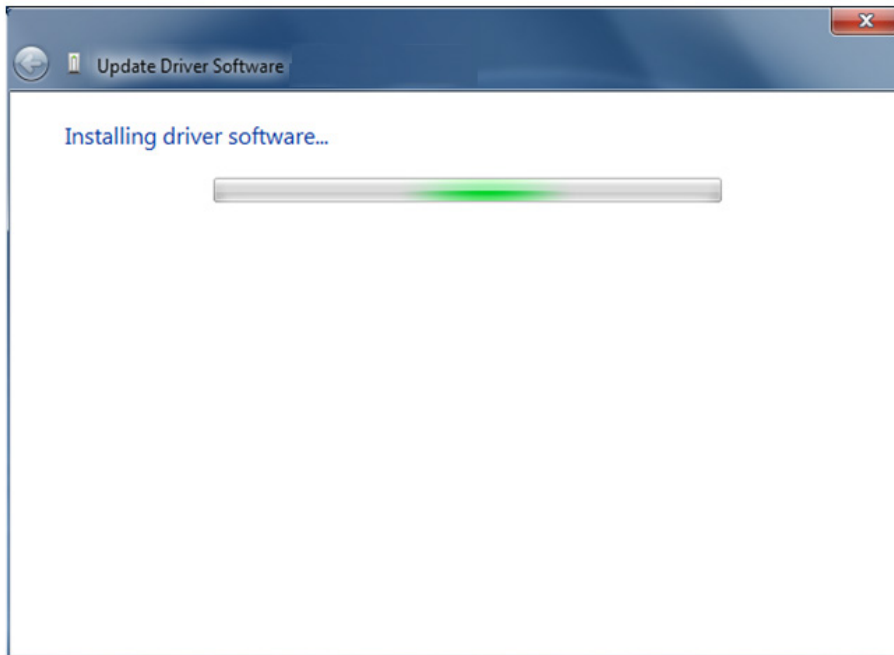

9. Windows will indicate that it cannot verify the editor of this driver. Confirm the installation anyway.

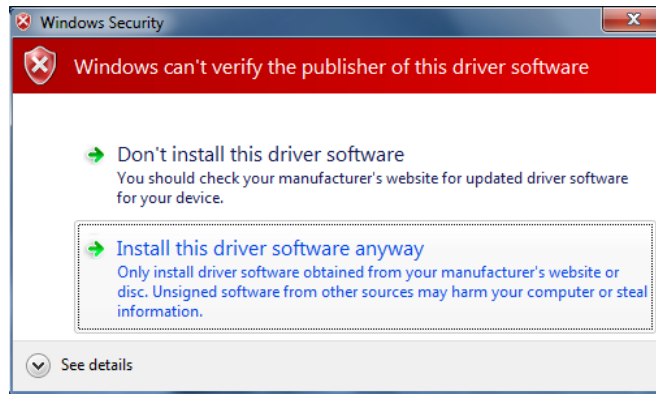

10. A message indicating successful installation will then display.

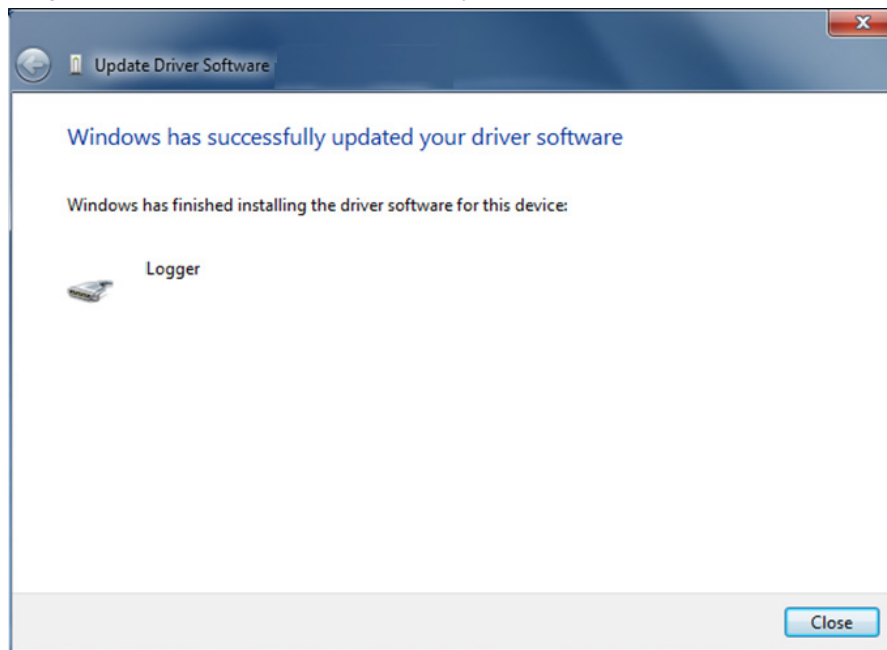

11. Returning to the Device Manager screen will allow you to check which virtual serial port is allocated to the **Data Logger**.

DEFINITION AND SELECTION OF SERIAL PORT (COM) - WINDOWS

The serial port associated to the **Data Logger** is automatically defined by the operating system right after connecting the **Data Logger**. The user can easily identify or change the COM port associated with **Data Logger**.

NOTE: The **Data Logger** may be referred to as the **FieldLogger** in some instances.

Control Panel / System / Hardware / Device Manager / COM & LPT Ports

Select the device "USB Serial Port" corresponding to the **Data Logger** and click on "Properties". Select "Port Settings" and click on "Advanced". In the "COM Port Number", select the serial port to be associated with **Data Logger**. Some serial ports can be checked while In Use. Just select one of these ports if you know that it is not being used by another peripheral device on your computer.

In some cases, the serial ports can be checked as in use even when the associated device is no longer installed on your computer. In this case it is safe to associate this port to **Data Logger**. The following figure presents the view of the device manager containing a **Data Logger**, and property screens where you can reset the associated COM port.

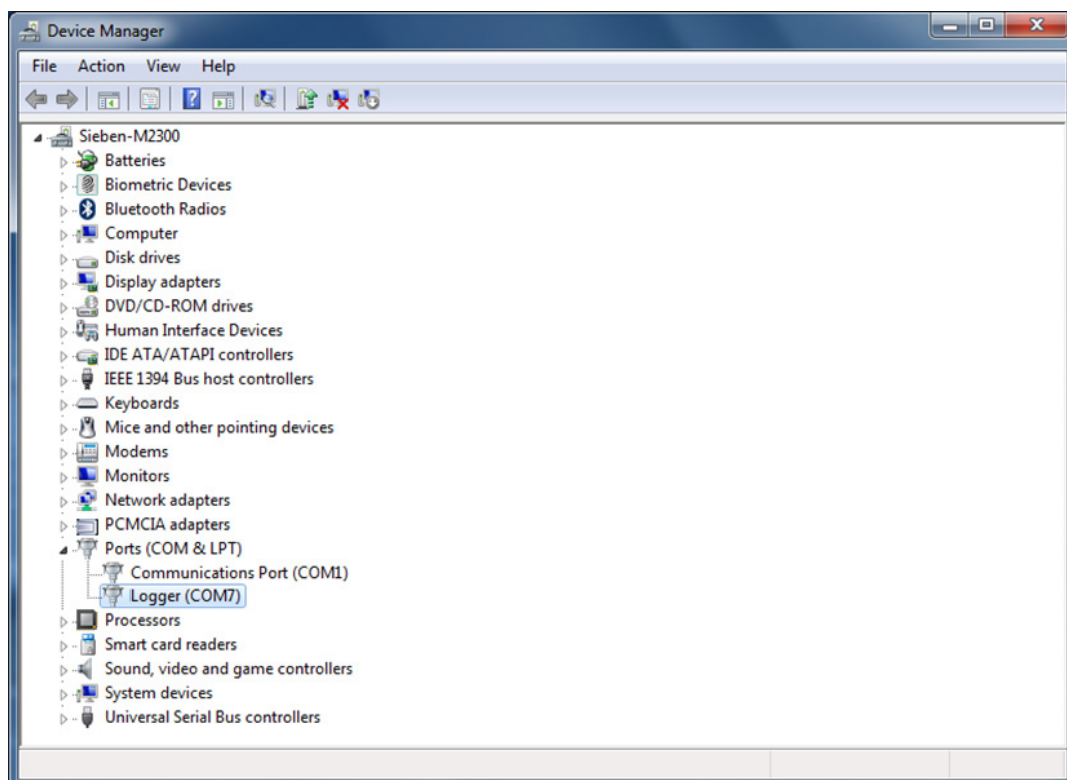

CONFIGURATION AND DATA DOWNLOAD SOFTWARE

The configuration software (Configurator) allows you to configure **Data Logger**, download and export recorded data and read input channels and status information. This chapter is intended to show and explain software usage. The use of the **Data Logger** with all its features will be detailed in the chapter "**Data Logger** Operation".

On the main screen, choose the function that you want to run from the four available:

- **Configuration:** Allows you to change the **Data Logger** configuration.
- **Diagnostics:** Allows you to read the values of the enabled channels, the status of configured alarms and general information and device status.
- **Download:** Allows you to download data from the **Data Logger** memory, view and export them in various formats.
- **Preferences:** It allows modifying some of the software options.

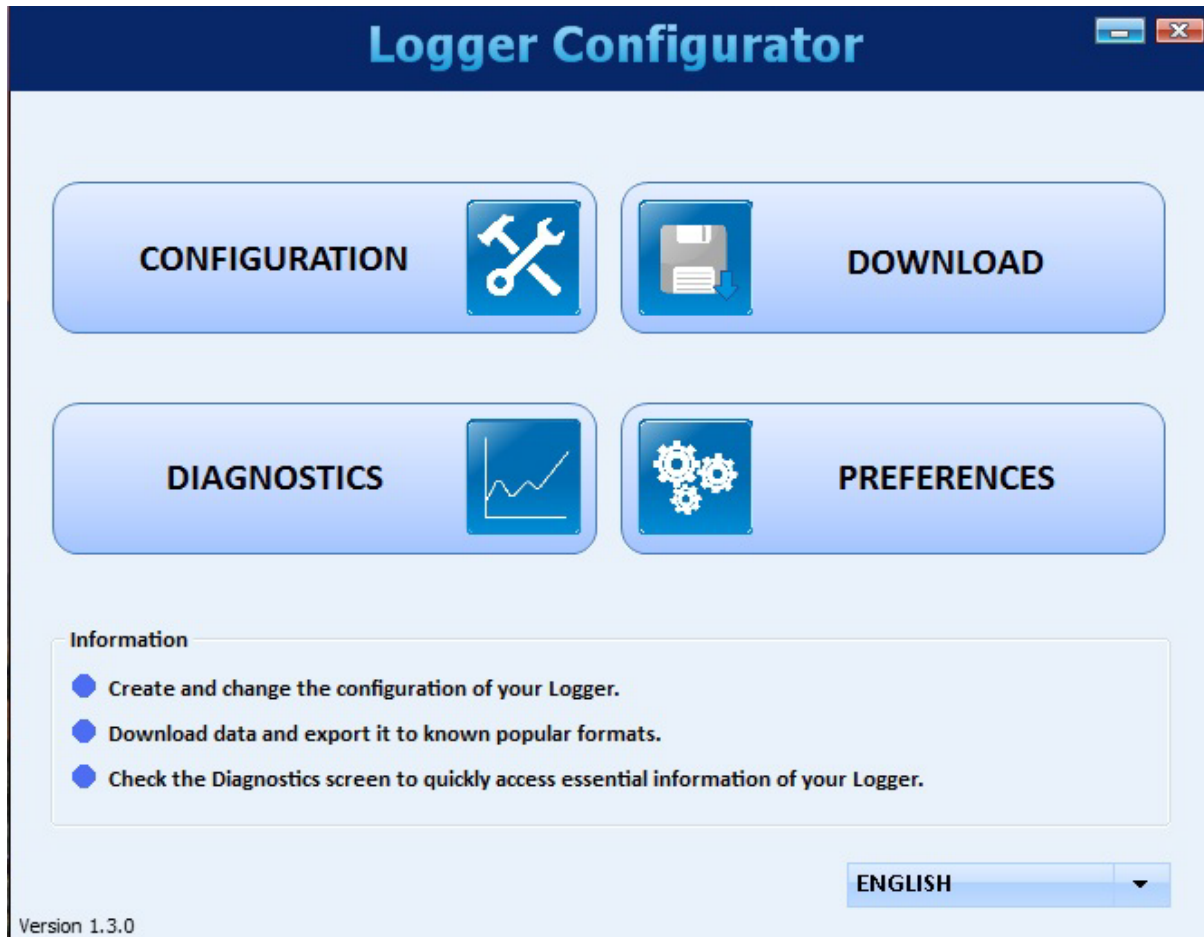

CONFIGURATION

On the configuration screen, you can select one of the following options:

- **Read Configuration:** Reads the current configuration of a *Data Logger*.
- **New Configuration:** Creates a configuration from the scratch.
- **Open Configuration:** Loads a previously configuration saved to a file on your PC.

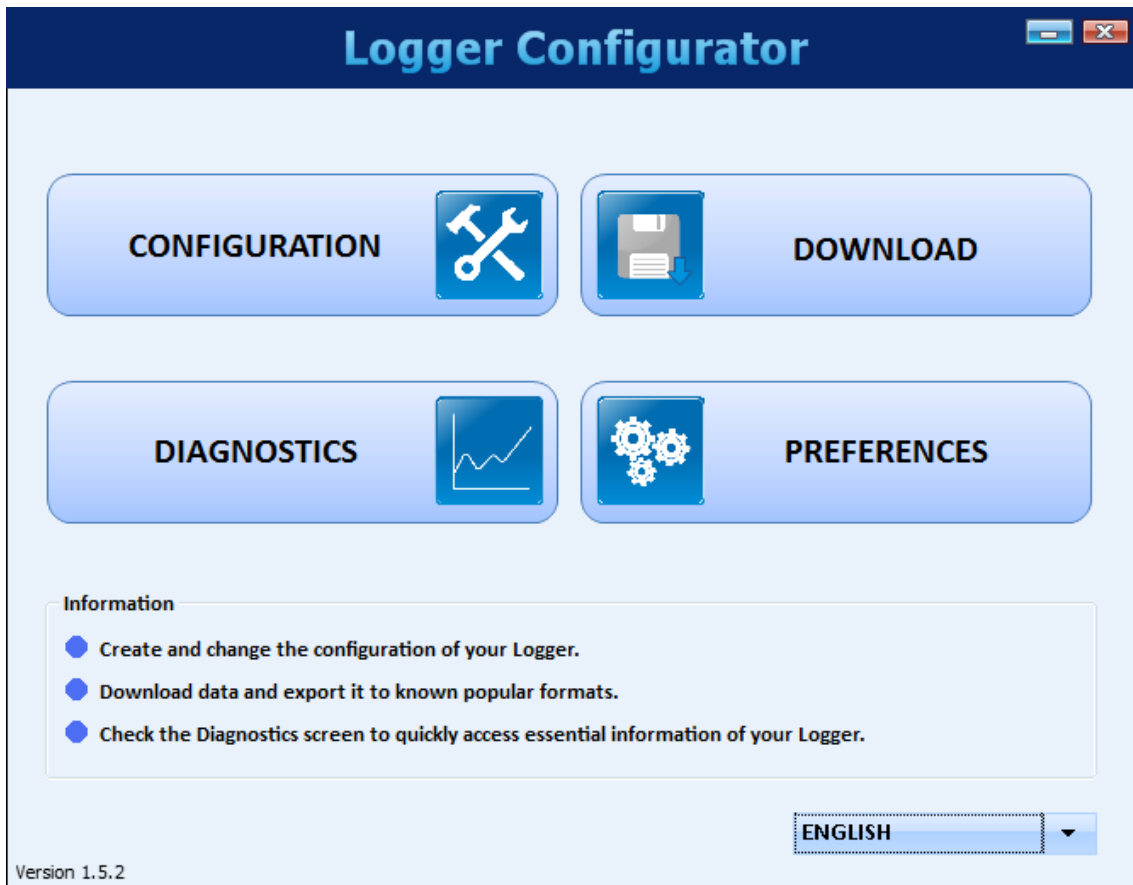

When choosing to create a new configuration, you must specify a file where this configuration will be saved.

For software version 1.40 and higher, you must select which Data Logger you are about to configure (power – normal or 24V – does not matter on this case):

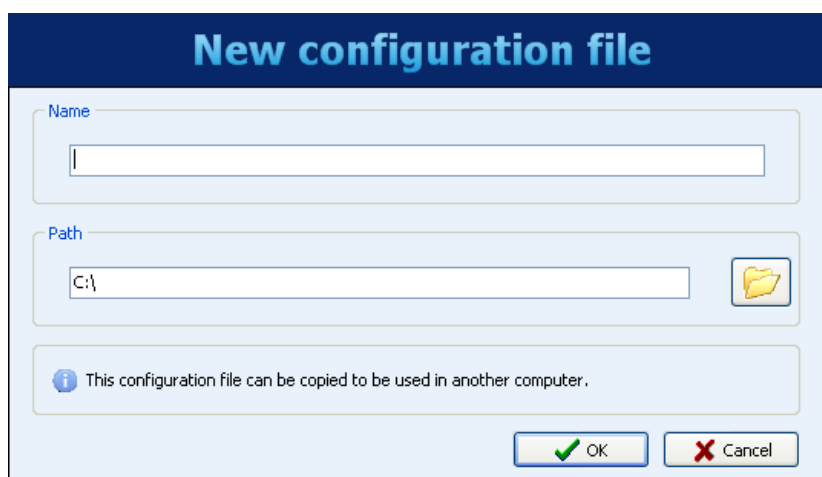

- Complete model, with Ethernet, USB, expansible memory using an SD Card and a second RS485 interface ready to accept an optional HMI.
- Model with USB but no Ethernet, non-expansible memory (internal flash only – no SD Card) and only one RS485 interface.

Once the configuration has been loaded into the software (originated from a device, a file, or simply created from scratch, according to the selected option), then you can make the desired configuration changes. There is a sequence of screens with various parameters arranged by functionality to accomplish this.

Each time you try to move onto the next screen (via the "Next" button), the configured parameters are checked. If there are problems with any parameter, an error window is displayed and the symbol "⚠" shows up next to the field that may not be consistent with other previous settings.

The icon bar at the bottom of the window has icons for the following functions:

- **Back:** Returns to the previous configuration screen.



- **Save:** Saves the current configuration to a file. If a file has not yet been associated with this configuration, it opens a dialog screen for the user to choose the name and location of the file.



- **Connection:** Allows connection to a Data Logger (opens a window for the interface selection) when it is disconnected and the disconnection when it is connected.



- **Load Screen Initial Configuration:** Undo the changes made by the user and returns to the initial configuration of the current screen.



- **Cancel:** Closes the current configuration.



- **Next:** Performs the settings check of the current configuration screen and, if everything is OK, goes to the next screen.



Icon toolbar

GENERAL CONFIGURATIONS

The first screen shows some general parameters for configuration for the **Data Logger**:

- Tag (name) to be given to the equipment (maximum of 16 characters).
- When using the DISPLAY with the **Data Logger**, you need to indicate the level of access that the operator will have:
 - **No DISPLAY access:** Prevents the use of the DISPLAY, because no parameter can be viewed by it in the **Data Logger**.
 - **Parameters reading:** The DISPLAY can be used only to view the channels and status of the **Data Logger**, no configuration changes are allowed.
 - **DISPLAY configuration and overall reading:** Full configuration of the DISPLAY is allowed, as well as viewing the channels and status of the **Data Logger**.
 - **Overall configuration and reading:** The DISPLAY can be used to configure parameters (its own and some for the **Data Logger**), in addition to viewing the channels and status of the **Data Logger**.
- Enabling data download by using a USB flash drive: it enables or disables the data download using a USB flash drive. When enabled, it also indicates the priority in case of a USB flash drive without enough space to download all requested data: more recent data or older data. In addition, you can configure the number of days (from the day of download, if the priority is the latest, or from the oldest data, if the priority is the oldest) that you want to download. Because of the fact that we do not make a copy of all data from the equipment's memory (which, in the case of SD cards, can be a lot of data), this can accelerate download time significantly.

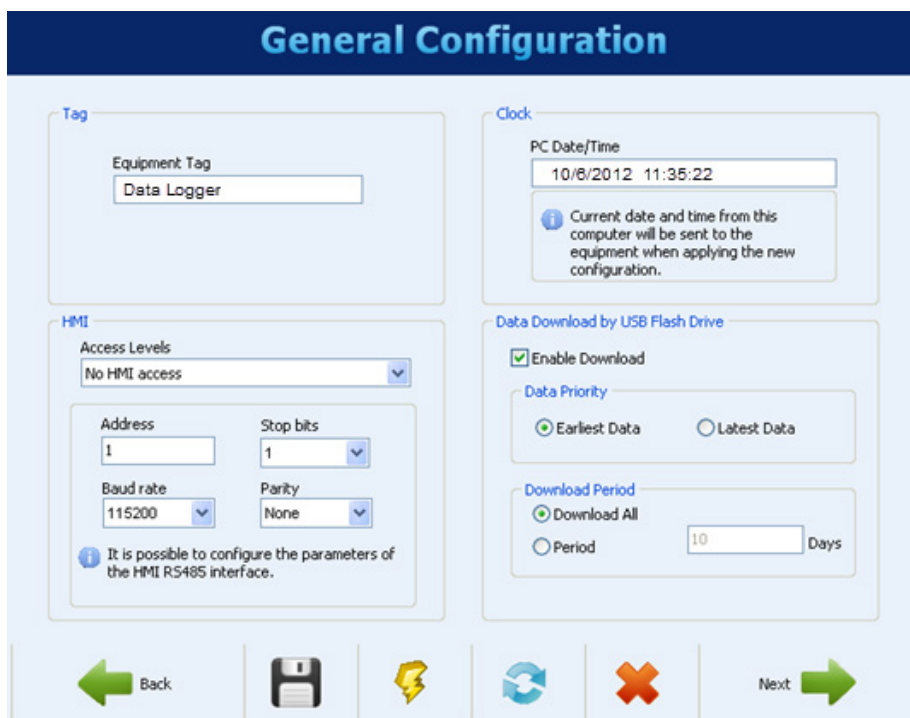

General Configurations

RS485 INTERFACE CONFIGURATION

Next configuration screen is the RS485 Interface screen. On this screen, you can choose the type of behavior for this interface: whether it will be a Modbus RTU slave, a Modbus RTU master or not be used at all. It is recommended to disable the interface if it is not used.

When it is used as a slave, you must configure your Modbus address, the baud rate, parity and number of stop bits.

When it is used as a master, it is not necessary to configure the Modbus address (only valid for the slaves). In this case, the configuration of Modbus network, where it indicates which registers are read from what slaves, will be carried through later, on the Remote Channels screen.

RS485 Interface

Mode

Disabled Master Slave

Parameters

Address: 1 Stop Bits: 2

Baud Rate: 115200 Parity: None

← Back [Floppy Disk] [Lightning Bolt] [Refresh] [X] Next →

Interface RS485

ETHERNET INTERFACE CONFIGURATION

The Ethernet interface configuration should be carried through the screen below. If it is to be used, it is recommended to disable it, as shown here.

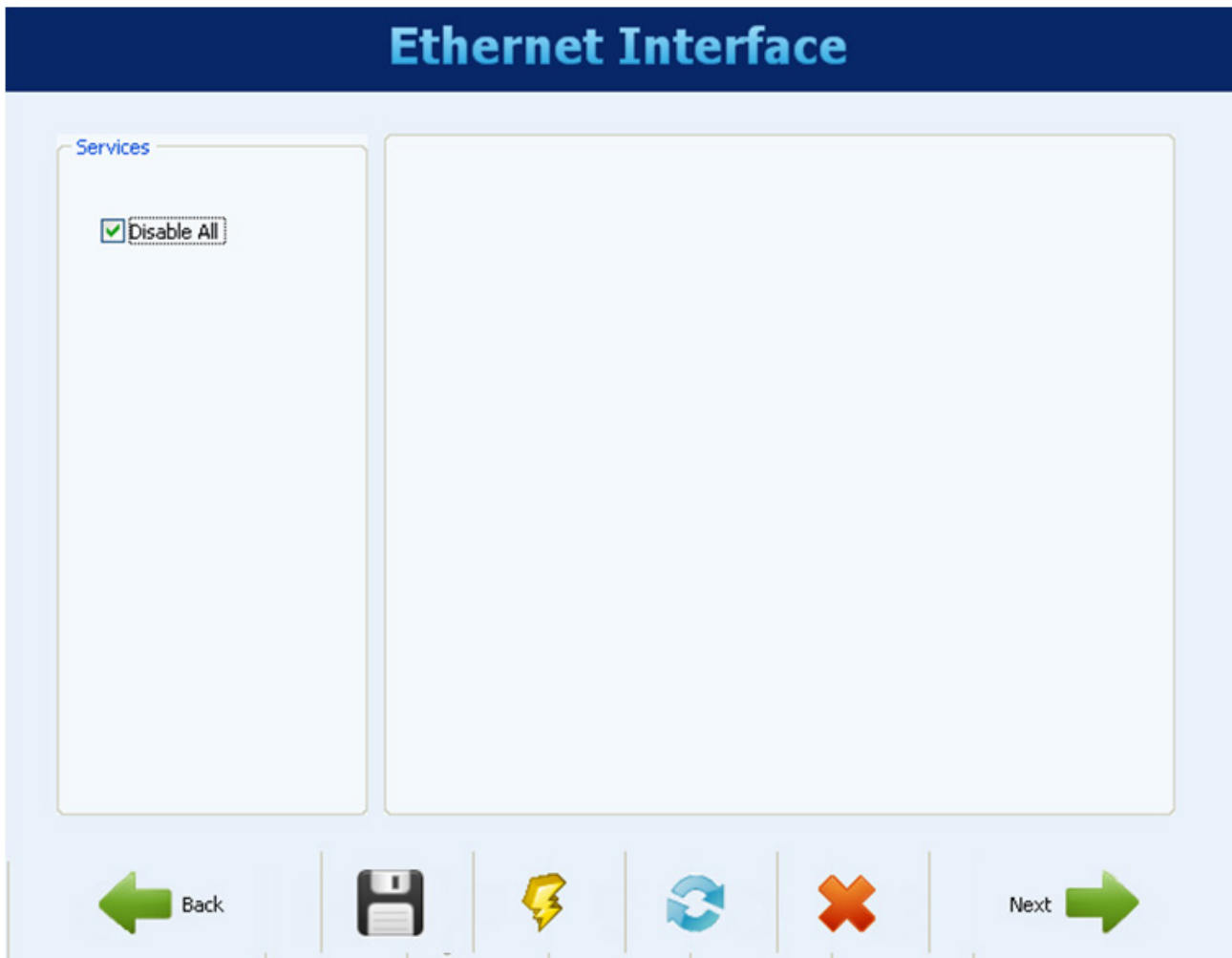

Disabled Ethernet Interface

ETHERNET INTERFACE CONFIGURATION - TCP/IP

Once the interface is enabled, the buttons on the left allow you to enable and configure each of the services offered by this interface. The icon on the right of each button shows whether the related service is enabled or not.

The first configuration to be made is the selection of fixed IP or DHCP and, in the case of fixed IP, to choose the parameters relating to it, such as **Data Logger** IP, the subnet mask and default gateway.

You must choose whether or not to use DNS, which can be used to connect to the e-mail server or FTP server (when the **Data Logger** is the FTP client for the daily download of data through this service). If so, you must configure the DNS server's IP address or, if the DHCP option has been selected, you can choose to search for the DNS server's IP from the DHCP server.

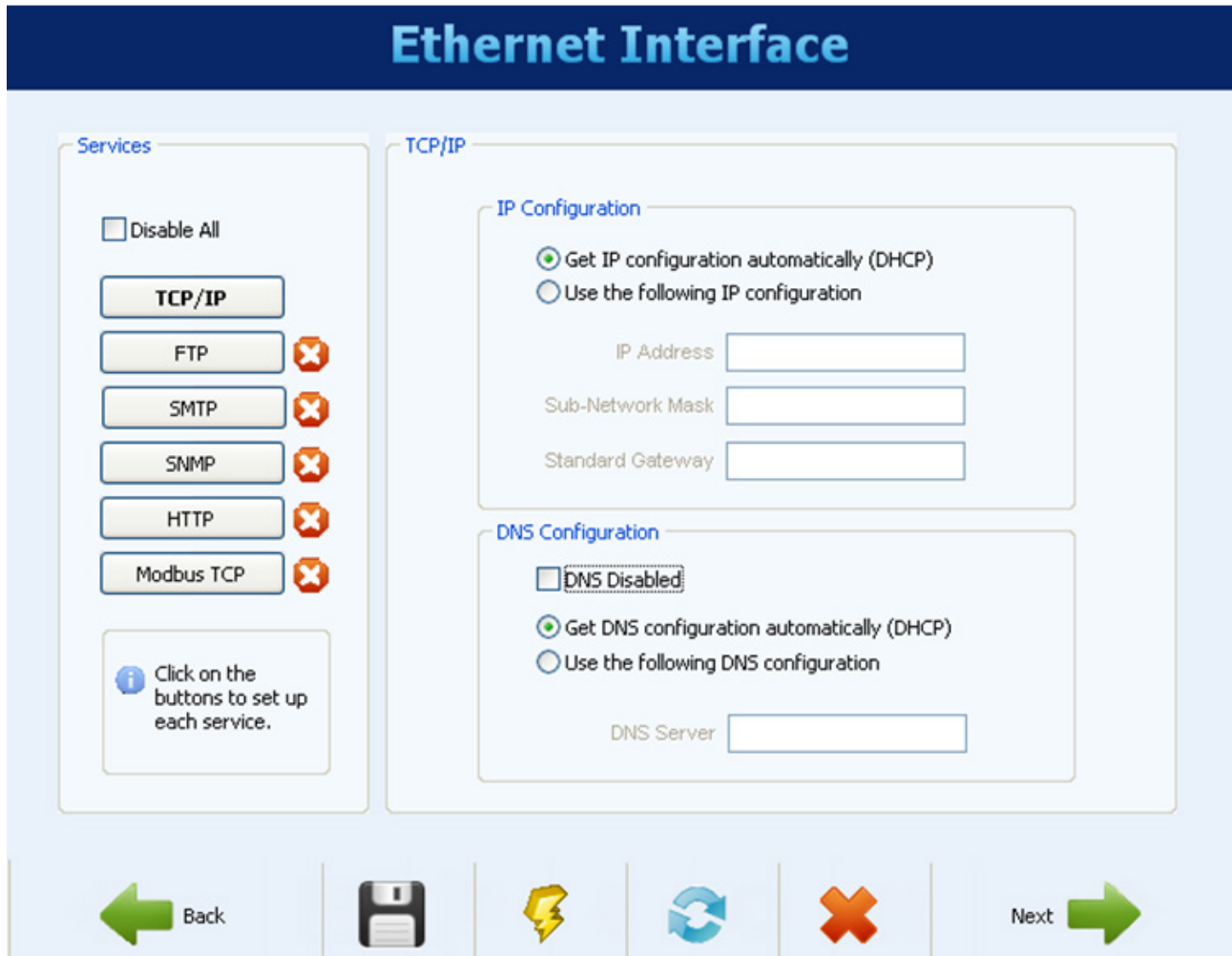

Ethernet Interface - TCP/IP Configuration

ETHERNET INTERFACE CONFIGURATION – FTP

The FTP button allows you to configure the options related to the FTP services. There are two types of FTP related functionality to choose from in the **Data Logger**: client and server.

As a server, the **Data Logger** allows for an external client to connect to it in order to download logged data, both from the SD card as well as from internal memory. You must configure the connection and access data, for user name (maximum of 10 characters), password (maximum of 10 characters) and connection port.

As a client, once a day at a set time, it will connect to a FTP server to send the data from its memory (internal or SD card). You must configure the following access parameters so the **Data Logger** will be able to access the server: user (maximum of 50 characters) and password (maximum of 10 characters), in addition to the IP address or server name (in case you enabled the DNS – name being up to 50 characters) and the server’s port.

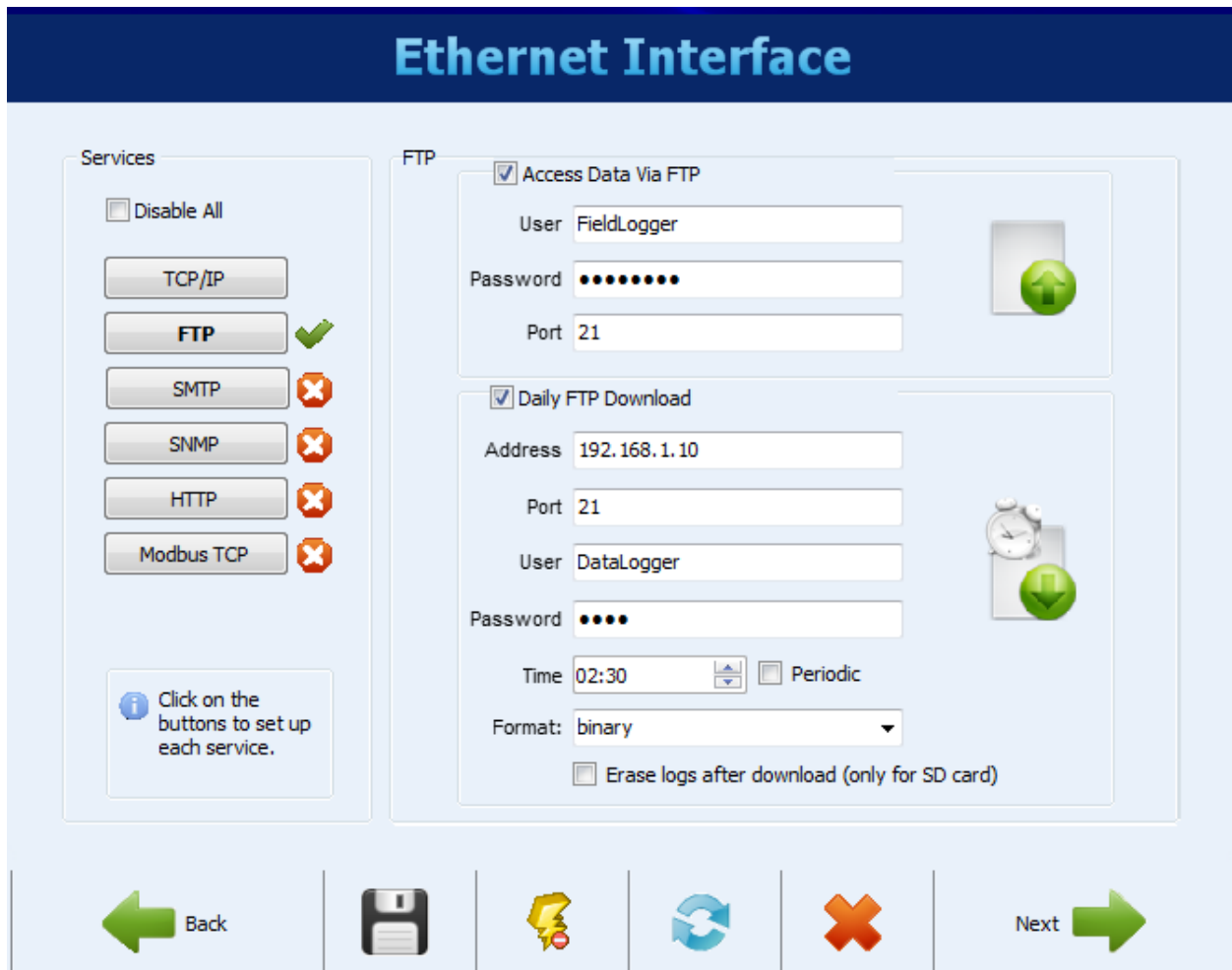

Ethernet Interface - FTP Configuration

ETHERNET INTERFACE CONFIGURATION - SMTP

The SMTP button allows access to the parameters related to sending e-mails. The **Data Logger** allows e-mails to be sent to multiple receivers when alarms or events are active. On this screen, the parameters related to the access to the e-mail server must be configured, such as its IP address or server name (in case you enabled the DNS – name being up to 50 characters), in addition to the user (maximum of 50 characters) and password (maximum of 12 characters).

Finally, you must configure the e-mail parameters to be sent in case of an alarm event. This e-mail has a subject (maximum of 32 characters) and has a part of the message body that is user defined (up to 64 characters) and it is the same for all alarms or events. The e-mail of the sender (maximum of 50 characters) and the e-mails of the receivers (maximum of 50 characters for each one) must also be configured.

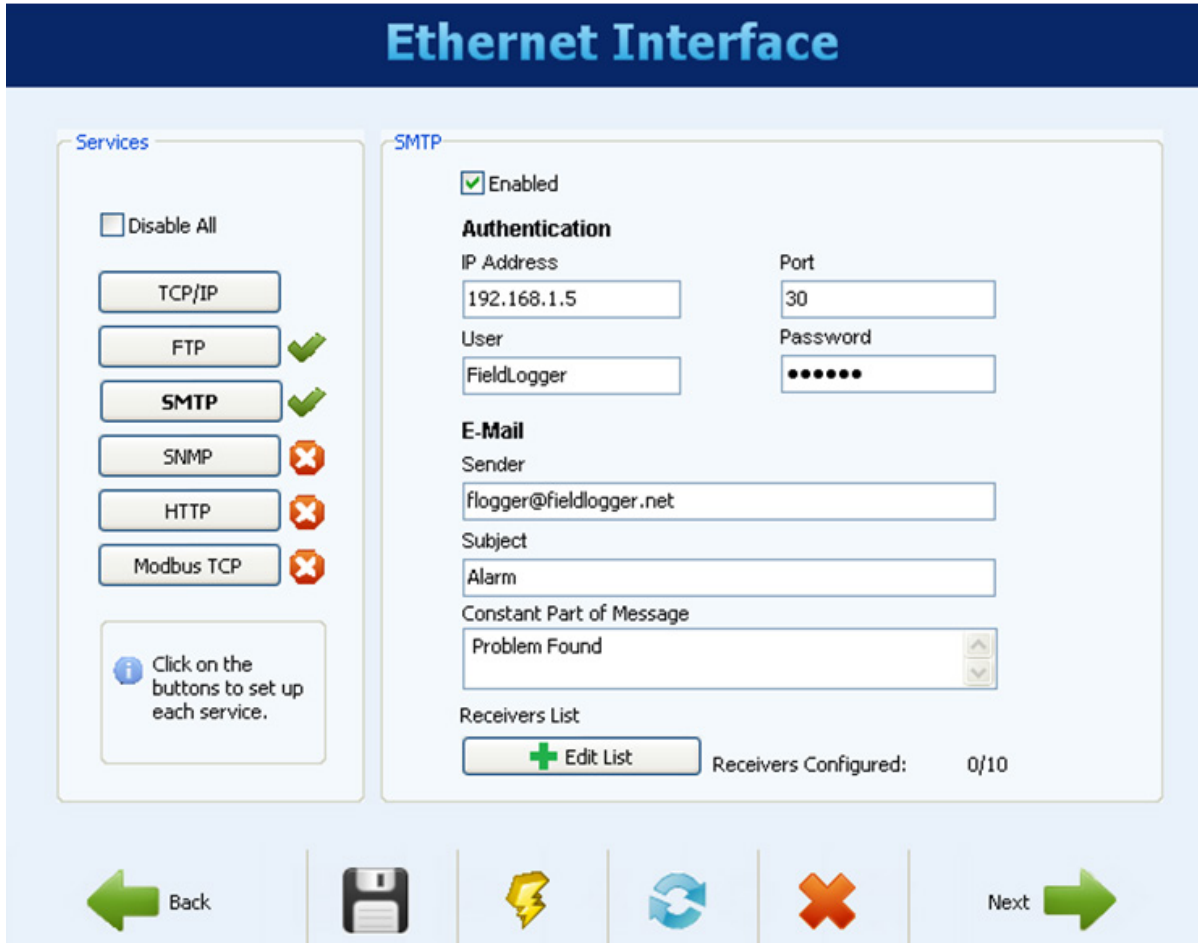

Ethernet Interface - SMTP Configuration

ETHERNET INTERFACE CONFIGURATION - E-MAIL RECEIVERS

To insert e-mail receivers, click on the "Edit List" button. A new window will open, allowing for the inclusion and removal of e-mails from the receivers list. All potential receivers of alarm or event e-mails must be included in this window. The choice of which alarms or events will be sent to which receivers will be made later, on the alarms configuration screen.

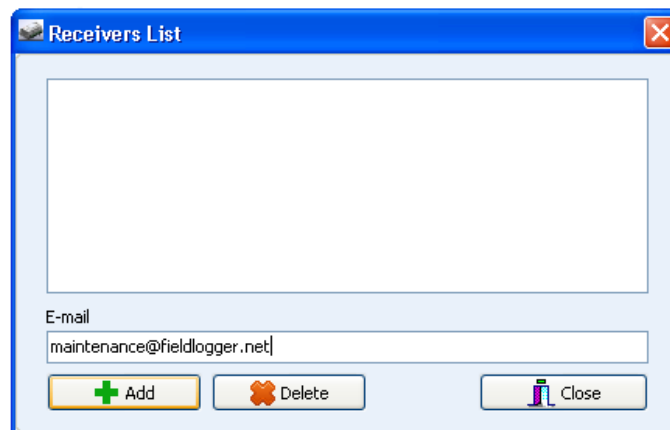

Ethernet Interface - Configuration of E-mail Receivers

ETHERNET INTERFACE CONFIGURATION - SNMP

The SNMP protocol can be enabled and configured by clicking on the SNMP button. SNMP in the **Data Logger** is read-only. Thus, you should set up the public access (maximum of 16 characters) and connection port.

For using traps, you must enable them separately. You should also set up the IP address and destination port for the traps.

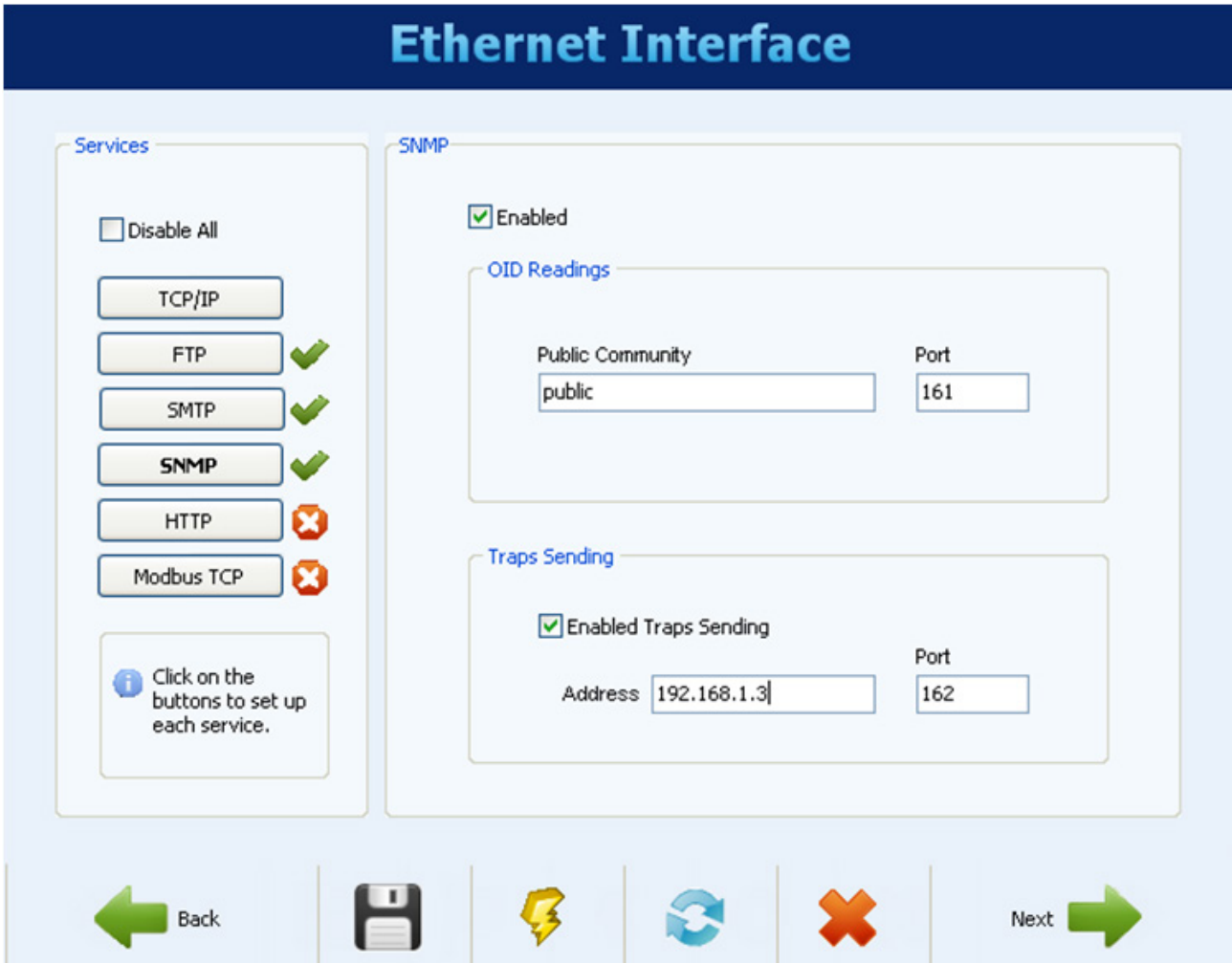

Ethernet Interface – SNMP Configuration

ETHERNET INTERFACE CONFIGURATION – HTTP

The HTTP button enables the **Data Logger** to serve a web page with some of its data. This page has an auto-refresh parameter, indicating to the browser software that the page should be reloaded with updated data from periodically. For this, the configuration needed is the connection port and the time in seconds between page updates.

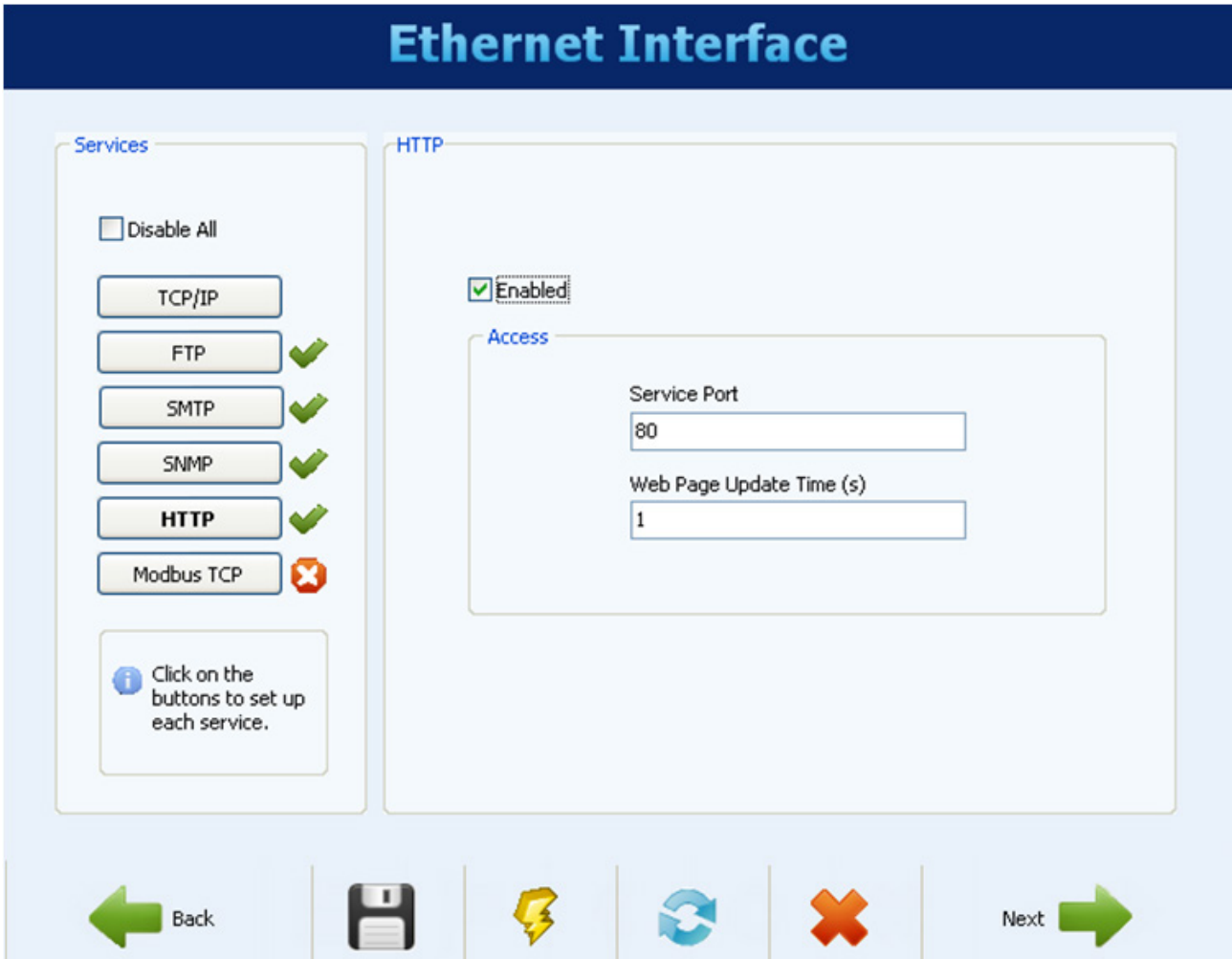

Ethernet Interface – HTTP Configuration

ETHERNET INTERFACE CONFIGURATION – MODBUS TCP

Finally, the Modbus TCP button allows you to enable the Modbus TCP communication protocol, used to read and write data to the **Data Logger**. Additionally the Configuration software itself uses this protocol to communicate with the **Data Logger** in order to read and write configuration parameters, view diagnostic data and download recorded data, when Ethernet interface has been selected. The **Data Logger** should be accessed by the “255” identification (ID). Any other ID used in a **Data Logger** Modbus-TCP access will be understood as being targeted to a RS485 slave in the RS485 network, reached through the gateway function. In this case, if this functionality is enabled, the data packet will be forwarded to the RS485 bus.

When the RS485 interface is configured as a Modbus master and Modbus TCP protocol is enabled, the gateway functions can be enabled, which allows the user to send Modbus commands using the Ethernet interface (Modbus TCP) to the slaves connected to the Modbus RTU network through **Data Logger**.



Data Logger operation as a gateway between a Modbus TCP network and a Modbus RTU network is only available from firmware version 1.10 or later.

Ethernet Interface

Services

Disable All

TCP/IP

FTP ✔

SMTP ✔

SNMP ✔

HTTP ✔

Modbus TCP ✔

i Click on the buttons to set up each service.

Modbus TCP

Enabled

Access

Service Port

Use equipment as a Modbus TCP/Modbus RTU gateway

Protocol

Modbus TCP
 Modbus RTU over TCP

 Back









Next 

Ethernet Interface - Modbus TCP Configuration

ANALOG CHANNELS CONFIGURATION

On the next screen, you must configure the analog channels that will be used. Each channel is individually configured, so you should first select which channel to be configured in the list on the left.

After the channel has been selected, you must configure its parameters on the right. For each channel, you must configure a tag (name with a maximum of 16 characters) and an input type. Depending on the selected input type, the indication limits must also be configured. For temperature sensors, you must choose whether the indication will be in Celsius or Fahrenheit, for the others, you can type a string for the unit (maximum of 10 characters).

There is also the option to enter an error value to be displayed when an error is detected on the input signal, such as an open 4-20mA loop or a Pt100 with a broken cable. It is also possible to configure a digital filter for the input channel (the higher the value, the more filtering applied to the channel, making the response more immune to noises on the input signal, but also slower to respond to variations - maximum filter value is 20).

There is also an option to use Custom Calibration. This feature allows up to 10 pairs of points to be inserted in a "correction table" (per analog input) in the device, creating segments for adjustments to the indicated value. Further details can be found in the "**Data Logger** Operation" chapter.

The number of decimal places to be displayed must also be configured. This parameter refers to the following cases:

- Reading the value of the channel via Modbus 16 bits registers (INT16 with signal). Further details can be found in "Data Logger – Modbus".
- Reading the value of the channel via DISPLAY.
- Reading the value of the channel through the HTML page generated by **Data Logger** itself (HTTP service on the Ethernet interface).
- Reading the value of the channel through the OID reading of SNMP protocol (SNMP service of Ethernet interface).
- Reading the alarm value related to the channel when receiving e-mails from the **Data Logger** (SMTP service on the Ethernet interface).

Analog Channels

Channels

- Channel 1 Enabled
- Channel 2 Enabled
- Channel 3 Enabled
- Channel 4 Enabled
- Channel 5 Enabled
- Channel 6 Enabled
- Channel 7 Enabled
- Channel 8 Enabled

Scan Interval

x 1 ms x 1 s

Parameters

Tag: Error Value:

Input Type:

Limits

Min. Max.

Unit

°C °F

Digital Filter: Decimal Places:

Configured Calibration Points: 0/10

Back Save Refresh Reset Cancel Next

Analog Channels - Configuration of a temperature channel

Analog Channels

Channels

- Channel 1 Enabled
- Channel 2 Enabled
- Channel 3 Enabled
- Channel 4 Enabled
- Channel 5 Enabled
- Channel 6 Enabled
- Channel 7 Enabled
- Channel 8 Enabled

Scan Interval

x 1 ms
 x 1 s

Parameters

Tag

Input Type

Limits
Min. Max.

Unit
 °C °F

Digital Filter

Decimal Places

Customized Calibration

Configured Calibration Points 0

Error Value

Back

Next

Analog Channels – Configuration of a linear channel

ANALOG CHANNELS CONFIGURATION – CUSTOM CALIBRATION

Using the "Custom Calibration" button, you can enter up to 10 custom calibration points for each analog channel as described below:

1. Disable the custom calibration of the channel to be adjusted, deleting all points configured for it, and apply this setting.
2. In the points to be adjusted, apply the standard value and write down the value indicated by the equipment.
3. Afterwards, insert the pairs of Custom Calibration points (source value and indicted value) and apply the configuration.

Customized Calibration

CHANNEL 6

Enabled

Values

Standard: 24 FieldLogger: 25

+ Add ✖ Delete

✖ Delete all

#	Standard indication	FieldLogger indication

✓ Apply ✖ Cancel

Analog Channels - Custom Calibration

Customized Calibration

CHANNEL 6

Enabled

Values

Standard: FieldLogger: |

+ Add ✖ Delete

✖ Delete all

#	Standard indication	FieldLogger indication
1	24.000000	25.000000

✓ Apply ✖ Cancel

Analog Channels - Custom Calibration

DIGITAL CHANNELS CONFIGURATION

After configuring the analog channels, next configure the digital channels and relays. Just as it is in the analog channels, on the list on the left, you can select which channel is to be configured.

Each channel can be configured as an input or an output. As an input, you can enable it or not. If it is disabled, it will not appear as an option in the logs, alarms, in the virtual channels or even on the DISPLAY. Once the input has been enabled, you must provide a unique tag (name - maximum of 16 characters) for this channel. You should also provide a value to be displayed when in "0" level (low voltage level or contact closed at the input) and another value to be indicated when in "1" level (high voltage level or contact open at the input). These values will be shown in the channel reading. Optionally configure a unit (maximum 10 characters) for the input.

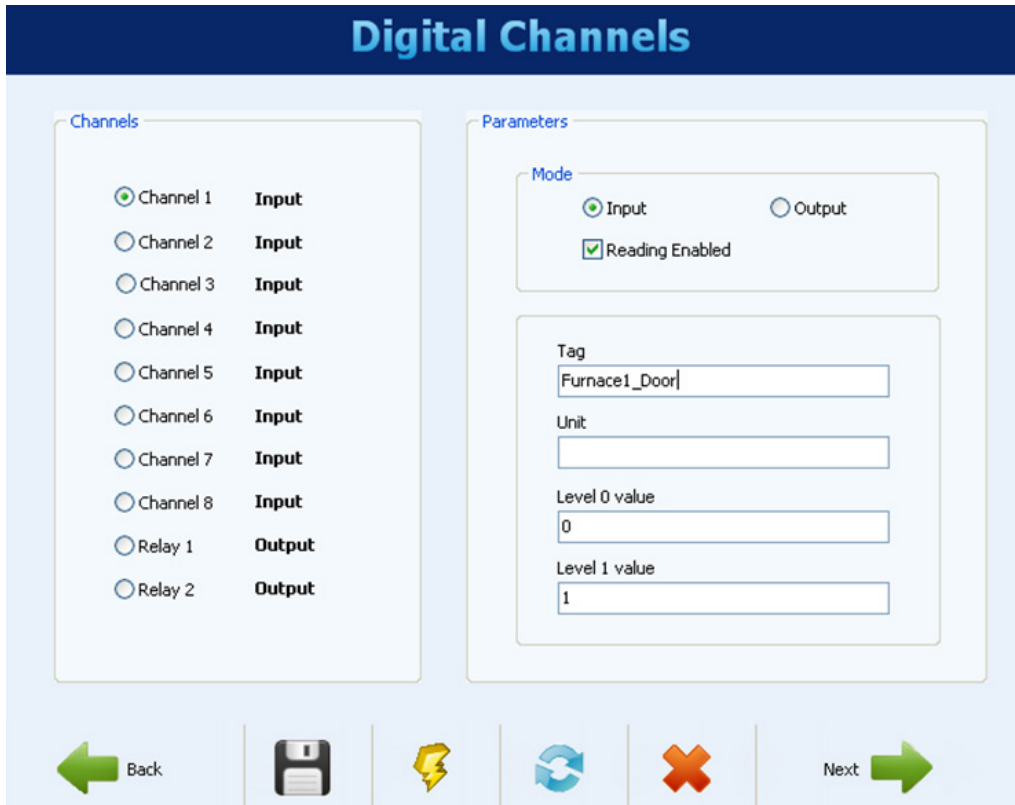

Digital channels - Configuring an input

It is possible to perform counting on the digital inputs from firmware version 1.10 or later. No special configuration is needed; just configure digital channels as inputs. The counting values can be accessed by Modbus registers (check the section on "Data Logger – Modbus") and can also be copied to a virtual channel, where it can be logged or used by the alarms, for example. When applying a new configuration in the digital channels, the all previously collected counting values are reset to zero.

When configured as an output, you should indicate whether this output may be triggered by **Data Logger** alarms & events or if it will be controlled by external Modbus commands, coming from a PLC or SCADA software, for example.

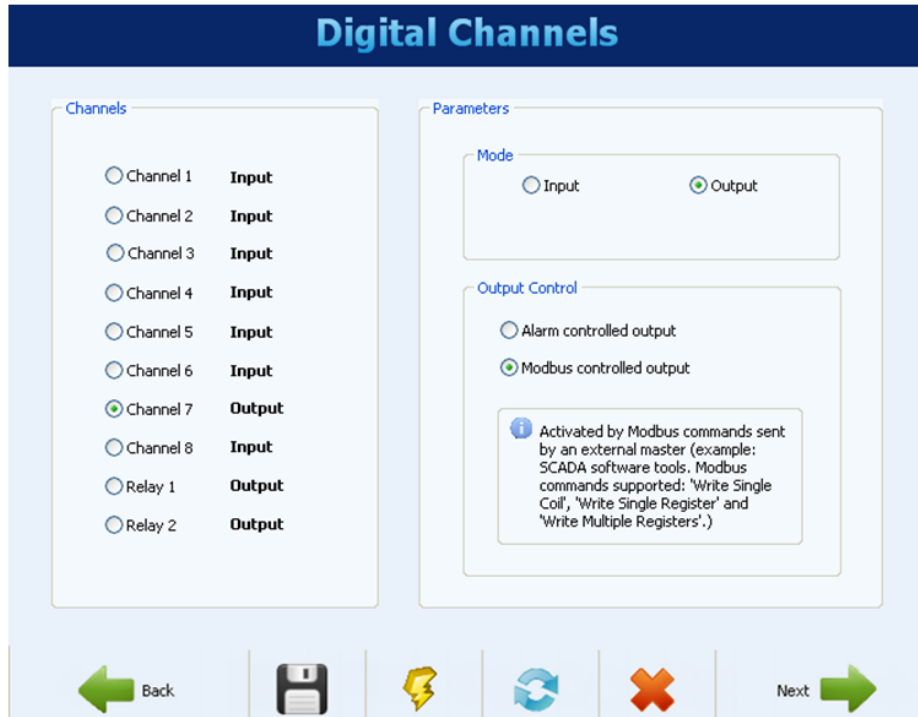

Digital channels – Configuring an output

The two **Data Logger** relays are also configured on this screen and their configuration is similar to that of other digital outputs. You must indicate whether they are triggered by internal alarms or external Modbus commands.

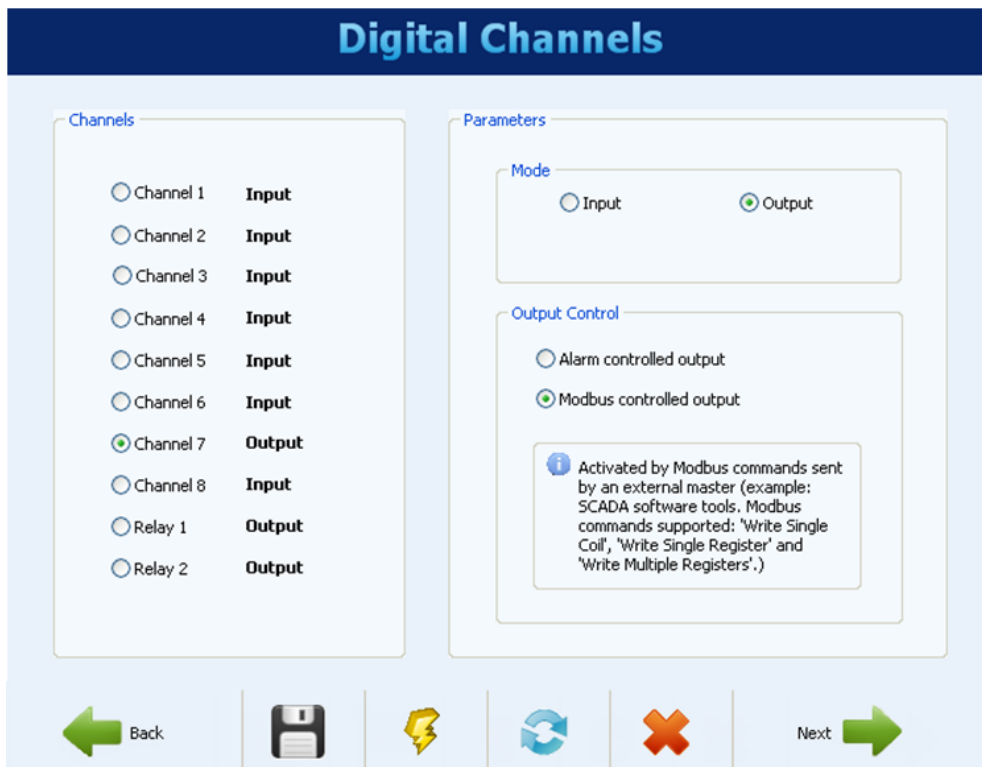

Digital Channels - Configuring a relay

REMOTE CHANNELS CONFIGURATION

The configuration of remote channels is only available when the RS485 interface has been configured as a Modbus master. In the case of the RS485 interface having been configured as a slave or disabled, the remote channels screen will display a message indicating the inability of its configuration.



If the RS485 interface was configured as Modbus master, the following screen will be displayed. You should set up a tag (name - maximum of 16 characters), unique for each channel, and optionally a unit (maximum of 10 characters) for the reading value.

In addition, for each channel, you should set up which network slave is to be read, what Modbus command should be used and what is the initial register to be read from the slave. In the current version, the number of registers is always "1", which means that you cannot do block reading.

An error value must also be configured. This value is shown on the channel when there is a problem, for example, a communication error with the slave.

After channel configuration, you must click on the "Add" button in order to enter the channel in the list to the left. If you want to remove a channel from the list, you must select it from the list and click on "Remove".

Remote Channels - Setting up a channel

At the bottom of the screen there are the general parameters for the Modbus Master configuration. The reading interval, given in tenths of seconds (maximum 18,000, equivalent to 30 minutes) is the time that you want the **Data Logger** to perform a new scan of all configured remote channels. The number of trials (valid range: 1 to 10) is how many attempts are made in sequence for the reading of each channel (if the communication fails in all attempts it will display the error value set up for the channel).

The maximum response time it will wait for the slave's response (valid range: 2 to 10,000 ms) indicates how long it will wait after sending the command from the master. If the answer does not come within this time, it will be considered a communication error and a retry (if configured) will be carried through. The time between commands (valid range: 1000 to 5000 ms) indicates how much time **Data Logger** will wait between receiving the slave's response and sending the next command.

Remote Channels

Channels

..... Temperature

1/64

Channels parameters

Tag

Modbus Slave Address

Modbus Command

Initial Register

Unit

Error Value

Unsigned value

+ Add/Modify

✖ Delete

✖ Delete All

Configuration

<p style="font-size: 0.8em;">Reading Interval (x 0.1 s)</p> <input style="width: 95%;" type="text" value="20"/>	<p style="font-size: 0.8em;">Attempts</p> <input style="width: 95%;" type="text" value="2"/>	<p style="font-size: 0.8em;">Max Response Time (ms)</p> <input style="width: 95%;" type="text" value="500"/>	<p style="font-size: 0.8em;">Time Between Commands (ms)</p> <input style="width: 95%;" type="text" value="50"/>
---	--	--	---

← Back

✖

Next →

Remote Channels - Inserting a channel in the list

VIRTUAL CHANNELS CONFIGURATION

The following screen allows configuration of the virtual channels. Each virtual channel is the result of a mathematical or logical operation and must be configured by selecting a unique tag (name - maximum of 16 characters) for this channel. You should then select the first channel that will serve as the operand (depending on the selected operation, it will be the only one). When you select "Constant Value", you will be able to assign a numeric value to the virtual channel (this value can be used as an operand in other virtual channels). Next, you must choose the operation to be performed and which channel is to be used as the second operand in the operation (when previously chosen "Constant Value", place the numeric value of the channel).

Finally, choose a unit (optional - maximum of 10 characters) for the channel, plus an error value and the number of decimal places desired in the indication of the same one. When clicking on "Add", the newly configured channel is added to the list of virtual channels.

When a virtual channel is configured, all enabled input channels are available for use as operands, including virtual channels already placed in the list. This enables you to generate relatively complex expressions, using the result of an operation as an operand in another one. For more details, please refer to the section on "Virtual Channels" under the chapter "Data Logger Operation".

Clicking on any virtual channel in the list, its parameters are loaded at the top fields. To delete a channel, you must select it from the list and click on "Remove". To delete all the virtual channels, you must click on "Remove All".

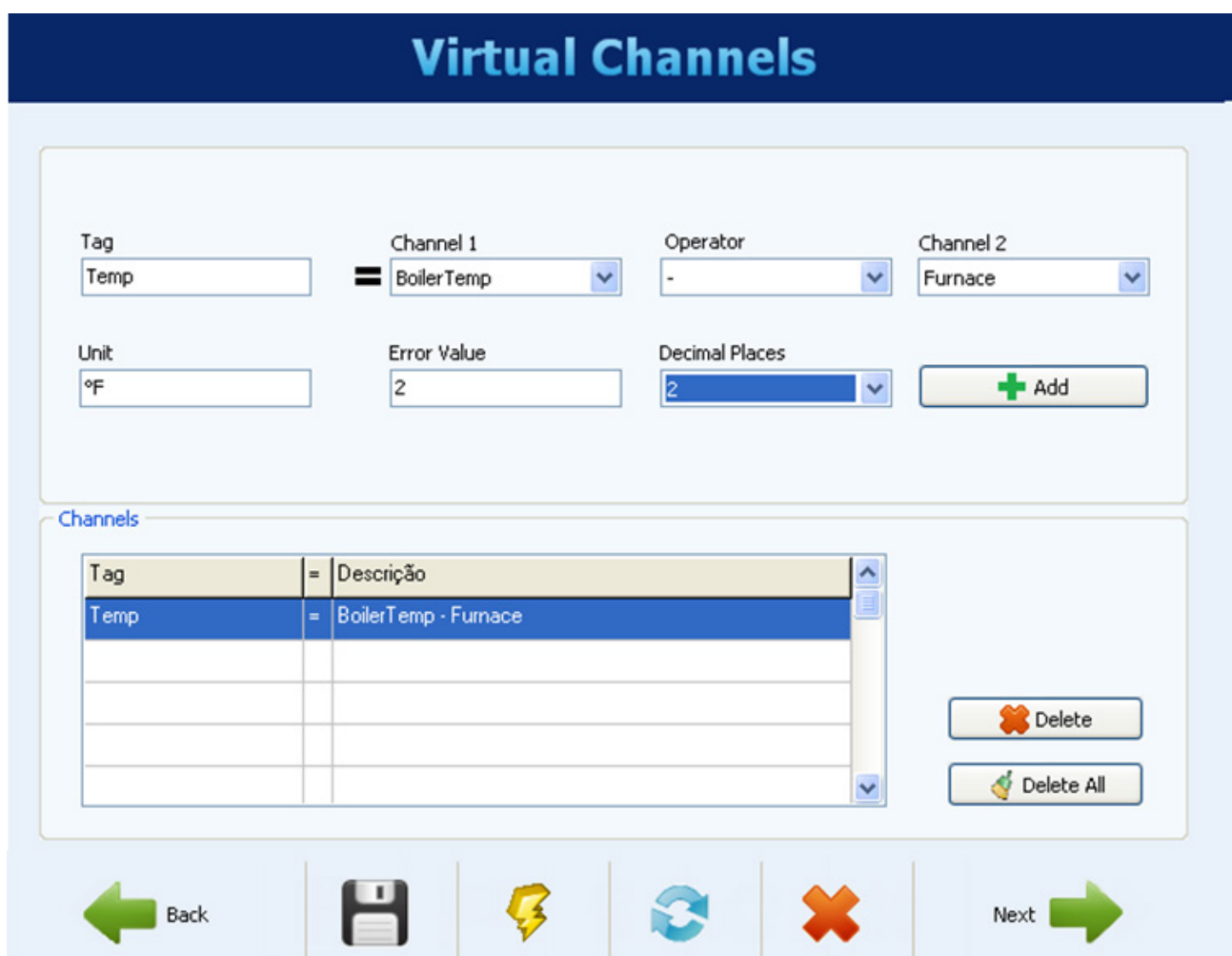

Virtual Channels

ALARMS CONFIGURATION

After setting up all channels, you can configure alarms to indicate error or exception conditions. You must choose which channel must be used for the alarm, what the alarm condition is, and what the set point (trigger value for the alarm) is. For example, you can select an analog temperature channel to alarm when the temperature exceeds a critical threshold, or a digital input channel to alarm when your state is different from the expected value.

A hysteresis can be configured to prevent a marginal condition, such as an input that hovers around the set point value, which would generate multiple alarm events. In some cases, like when the alarm channel is a digital input, the hysteresis does not make much sense and should be maintained at "0".

	Whenever a digital channel is used for an alarm, hysteresis shall not be used (must be configured with "0")!
---	--

Each alarm can have one or more associated actions. You should then choose what actions should be performed on the occurrence of an alarm or event (different actions are organized by tabs). The available actions are: activation of relays, activation of digital outputs (if they are configured to be triggered by an alarm), sending of e-mails to one or more receivers (selected from among the ones configured on the Ethernet interface configuration page), sending a SNMP trap and the start and/or stop of the recording. Finally, when everything is set up, include the alarm in the list by clicking on the "Add" button.

When clicking on an alarm from the list on the left, its parameters are loaded into the fields on the right. To delete a channel from the list, you must select it from the list and click on "Remove". To modify parameters of an alarm, you must select it from the list, make the desired changes and click on "Modify". The button "Delete all" deletes all alarms in the list.

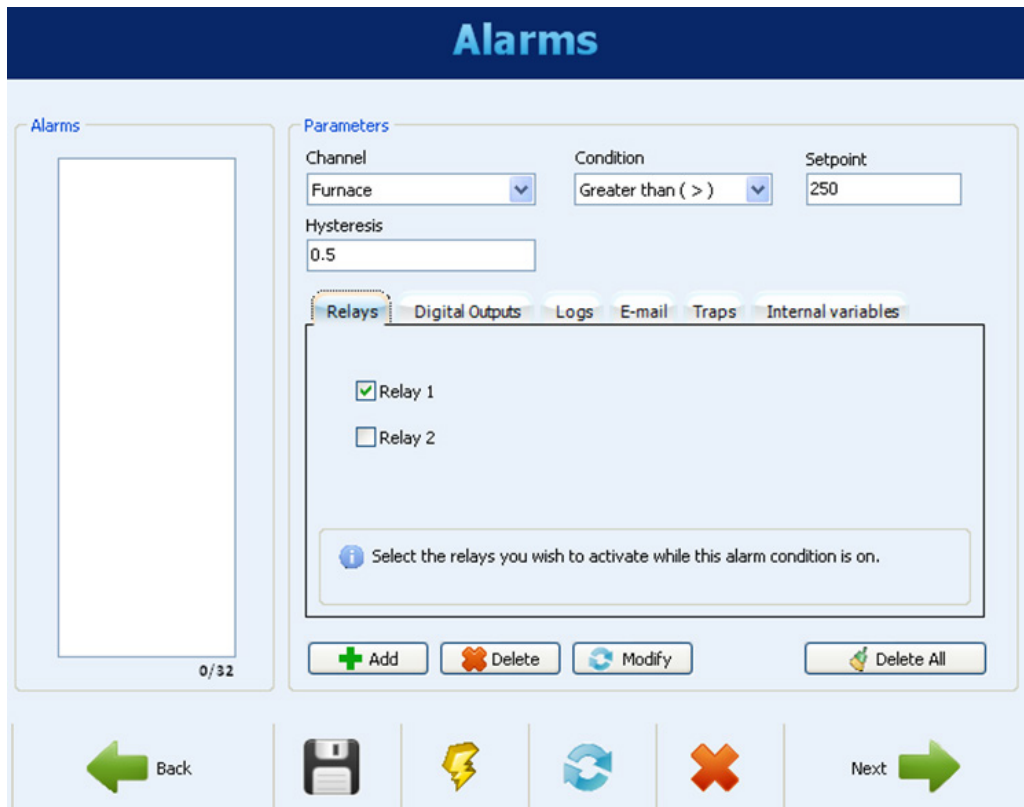

Alarms Configuration - Relays selection

The screenshot shows the 'Alarms' configuration page. On the left is a list of alarms, currently empty, with a '0/32' indicator. The main area is titled 'Parameters' and contains the following fields: 'Channel' set to 'Furnace', 'Condition' set to 'Greater than (>)', and 'Setpoint' set to '250'. Below these is a 'Hysteresis' field set to '0.5'. A series of tabs are visible: 'Relays', 'Digital Outputs' (which is selected and highlighted), 'Logs', 'E-mail', 'Traps', and 'Internal variables'. The 'Digital Outputs' tab contains a list of eight digital outputs, each with a checkbox: Digital 1, 2, 3, 4, 5, 6, 7, and 8. Only 'Digital 8' is checked. Below the list is an information icon and the text: 'Select the digital outputs you wish to activate while this alarm condition is on.' At the bottom of the parameters section are four buttons: '+ Add', 'Delete', 'Modify', and 'Delete All'. At the very bottom of the interface are navigation icons: a green arrow pointing left labeled 'Back', a floppy disk icon, a lightning bolt icon, a circular refresh icon, a red 'X' icon, and a green arrow pointing right labeled 'Next'.

Alarms Configuration - Digital outputs selection

This screenshot shows the same 'Alarms' configuration page, but with the 'Logs' tab selected. The 'Parameters' section remains the same as in the previous screenshot. The 'Logs' tab contains three checkboxes: 'Start Logging' (checked), 'Stop Logging' (unchecked), and 'Log while in alarm condition' (unchecked). Below these is an information icon and the text: 'Inform if this alarm condition must start and/or finish data logging.' The '+ Add', 'Delete', 'Modify', and 'Delete All' buttons are still present at the bottom of the parameters section. The navigation icons at the very bottom are identical to the previous screenshot.

Alarms Configuration - Logs control configuration

Alarms

Alarms

Parameters

Channel: Furnace Condition: Greater than (>) Setpoint: 250

Hysteresis: 0.5

Relays Digital Outputs Logs **E-mail** Traps Internal variables

supervisao@fieldlogger.com.br

Inform which e-mail receivers must be notified when entering this alarm condition.

+ Add Delete Modify Delete All

Back Next

Alarms Configuration - E-mail receivers selection

Alarms

Alarms

Parameters

Channel: Furnace Condition: Greater than (>) Setpoint: 250

Hysteresis: 0.5

Relays Digital Outputs Logs E-mail **Traps** Internal variables

Enable Traps

Inform if a SNMP trap must be triggered when entering this alarm condition.

+ Add Delete Modify Delete All

Back Next

Alarms Configuration - Enabling SNMP traps

Alarms

Alarms

Parameters

Channel: Furnace

Condition: Greater than (>)

Setpoint: 250

Hysteresis: 0.5

Relays | Digital Outputs | Logs | E-mail | Traps | **Internal variables**

Preset all accumulators

Preset all counters

Preset a single accumulator/counter

Channel name: [dropdown]

Preset value: 0

+ Add | Delete | Modify | Delete All

Back | Save | Refresh | Cancel | Next

Alarms Configuration – Selection the internal variables

Alarms

Alarms

Parameters

Channel: Furnace

Condition: Greater than (>)

Setpoint: 250,000

Hysteresis: 0.5

Relays | Digital Outputs | Logs | E-mail | Traps | **Internal variables**

Preset all accumulators

Preset all counters

Preset a single accumulator/counter

Channel name: [dropdown]

Preset value: 0,000

+ Add | Delete | Modify | Delete All

Back | Save | Refresh | Cancel | Next

Alarms Configuration - Alarm added to the list

LOG CONFIGURATION

The last page of the configuration is about logging. If data logging is not desired, you should disable it.

Log configuration should begin initially by choosing the start mode and stop mode for the logging process. If, on the previous screen, the start and/or stop of the loggings were assigned to one or two alarms or events, this option is disabled and cannot be changed on the Logs screen.

If you want to use the start and/or stop of the loggings through Modbus commands, you must enable these options. In addition, you must select where the logging data must be stored in the memory; in the internal flash (512k logs) or in the SD card inserted by the user.

Finally, you must select which channels you want to log and what is the desired storage rate. The channels can be selected for logging moving them from the left side column (available channels) to the right side column (channels to be logged). A maximum of 100 channels can be logged, but keep in mind that the more channels to be logged, the slower the storage rate that can be used.

The storage rate is given as a logging interval and it is common to all channels. For example, a rate of 1 second means that all channels selected will be stored once per second. Although the equipment allows for a rate of up to 1000 per second, you must bear in mind the following side effects:

- It is not good to have a storage rate faster than the scan rate of the analog channels or the scan rate of the remote channels. In this case, the logs would have repeated data.
- The more data that is in memory, the slower the download process will be and more data will be processed in preview and export.

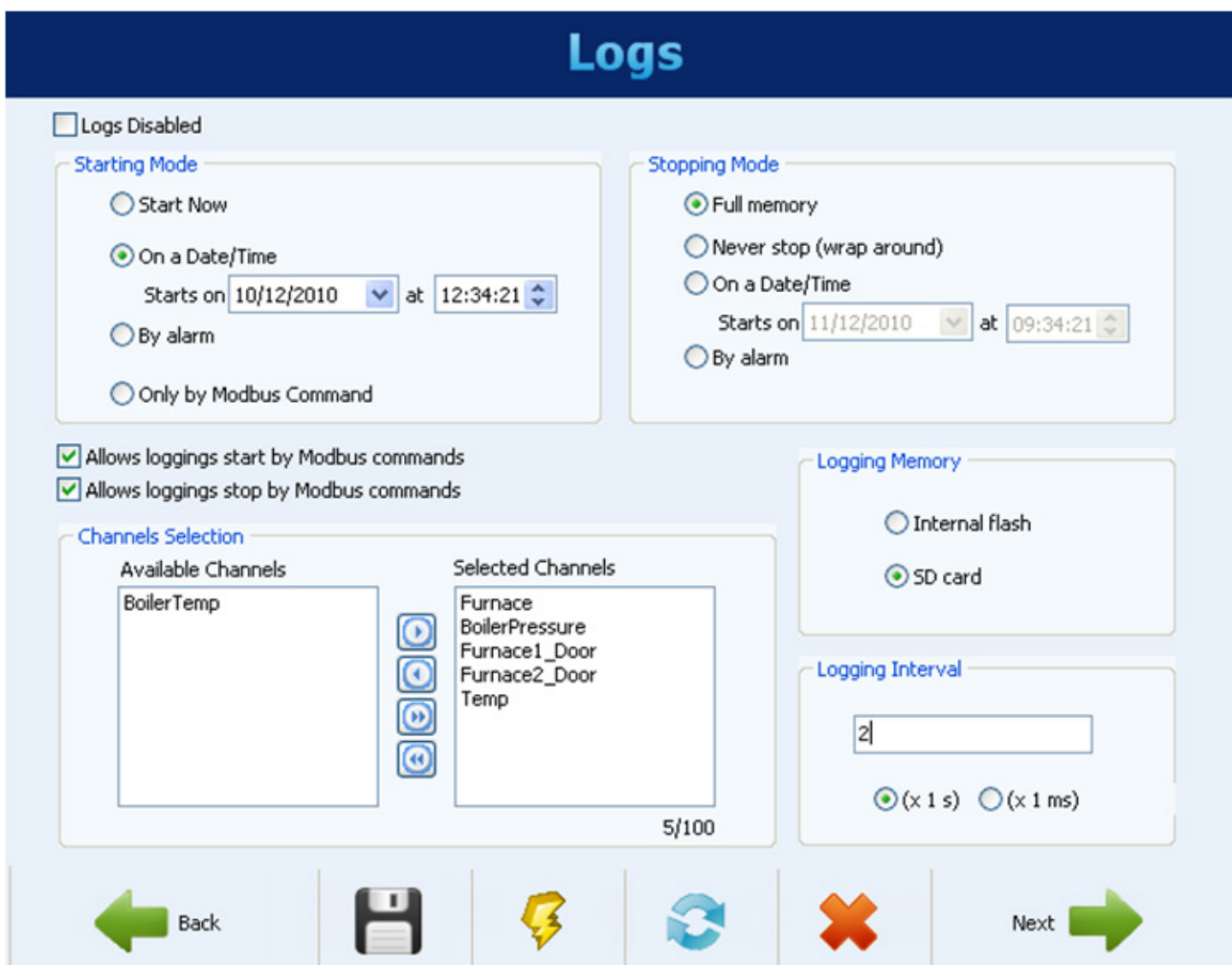

Logs Configuration – Logging configuration

After completing the configuration, you can send it to the data logger by clicking on the "Send" button. If the configuration was previously read from the data logger and the interface was not disconnected, the same interface used for reading will be used for writing otherwise you must choose which interface to use for sending the configuration.

Send Configuration to Equipment



Actions

Send

Reiniciar Registros ao Enviar Configuração

Save Configuration to File

File

Current configuration file

Save to a new file

Actions

Save

← Back

Next →

At the end of the transmission, a message will appear indicating the success (or failure) of the operation. You can save the configuration to a file to be retrieved in the future if desired.

Configuration

Writing 2 / 9

Writing Ethernet interface configuration...

If you just want to save it to a file instead of sending the configuration to the **Data Logger**, you must choose the file name and click on the "Save" button.

DIAGNOSTICS

When you select Diagnostics, the login screen will appear. You must indicate what interface will be used for reading the diagnostics parameters: RS485 (RS485 interface of the **Data Logger** should be selected as "slave"), USB or Ethernet (the Ethernet interface of the data logger must be enabled, as well as Modbus TCP protocol).

Reading parameters is then performed and the General parameters window is opened. This window shows the data logger's tag, serial number, firmware version and model. It also shows the time of its clock compared to the computer's clock. In this window you can also see the configuration parameters for the RS485 interface. For the Ethernet interface, the current status (connected or disconnected) is indicated, as well as the IP and MAC addresses. On the right side of the window, there is an indication of the connection status of the DISPLAY and the USB flash drive, in addition to the capacity and free space of the internal flash memory and the SD card (when connected). Finally, there is an indication of the current state of the recording and, when the start or stop of these through Modbus commands is enabled. There are buttons in order to perform the respective actions of starting and stopping the recording.

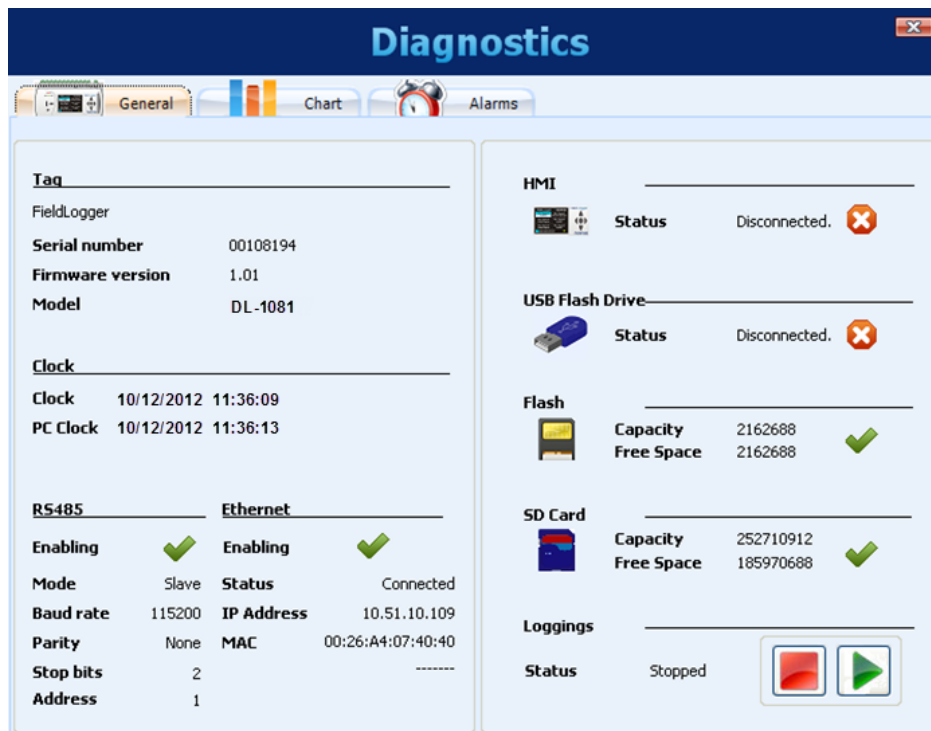

Diagnostics - General Status

On the Chart tab, you can select up to 6 channels to be viewed in a chart. At the bottom, you can select the channel to be displayed and its associated color on the chart. When all desired channels are selected, click on the "Start" button. The channel values will be read approximately every 2 seconds and will be plotted on the chart. If any channel is in error, the channel selection will be shown in red.

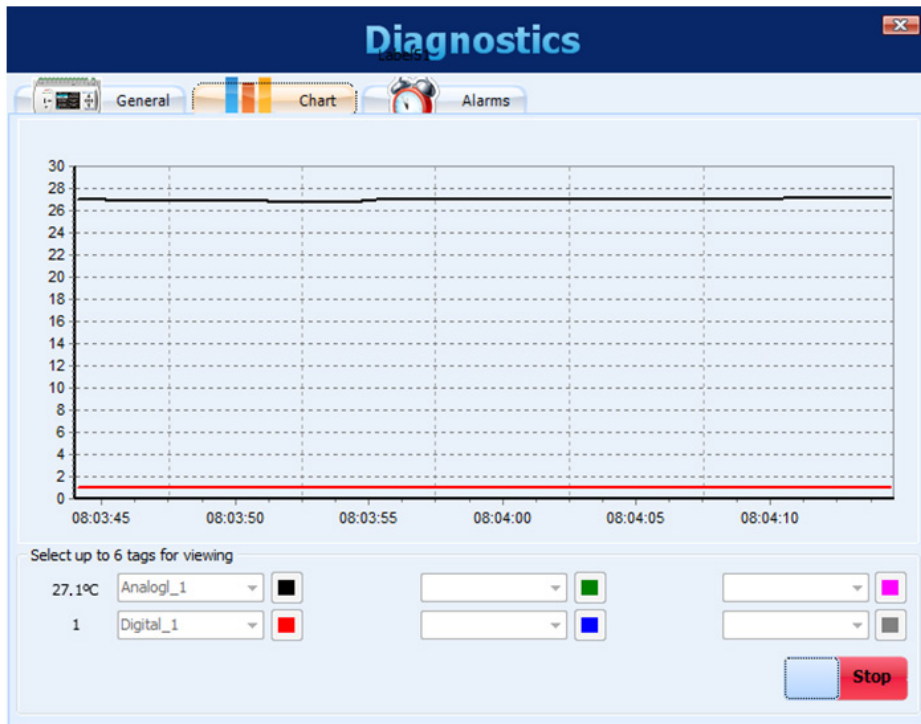

Diagnostics - Monitoring channels

On the Alarms tab, you can check the real-time status of all configured alarms or events. At the top, there is an indication of how many alarms are enabled and how many are in a state of alarm. In the list below, the settings for each alarm are shown. If the alarm is active, its configuration is shown in red.

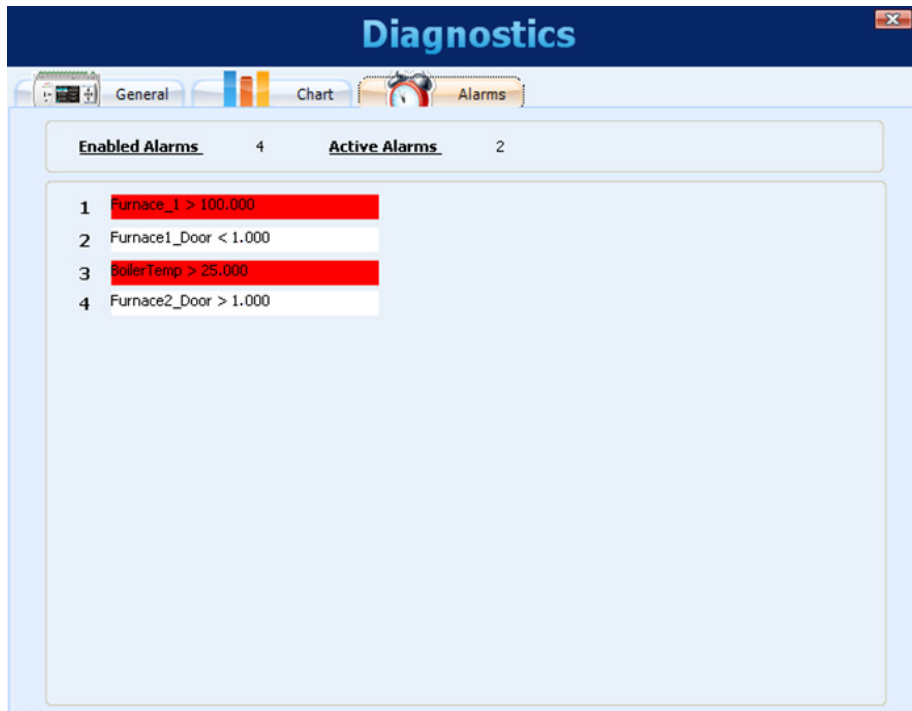

Enabled Alarms	4	Active Alarms	2
1	Furnace_1 > 100.000		
2	Furnace1_Door < 1.000		
3	Boiler Temp > 25.000		
4	Furnace2_Door > 1.000		

Diagnostics - Monitoring Alarms

DOWNLOAD

By selecting Download, you can download data from the **Data Logger**, search data previously downloaded from a folder or view or export logged data.

The user can create a folder on their computer (or their network) where a recording database will be created. This database may have data from one or more **Data Loggers** and will be the destination of all data downloaded from the **Data Logger**. From this database, the views and data export will look for the channel data.



The Download Manager screen has the following options:

- **Download Data**
- **Download Manager**

These options will be viewed in detail in the following sections.

DOWNLOAD DATA

When selecting this option, the first thing to do is choose the data source where the software should read data from.

The available options are:

- Download data from a Logger (requires a connection with the logger).
- Download data from a USB flash drive (in cases when the flash drive was used to retrieve data from **Data Logger**). The flash drive must be plugged in the computer.
- Download data from a SD card. The card must have been used in the **Data Logger** as the recording memory target. The SD card is recommended when large logging recording takes place because it is the fastest way of moving data to the computer.
- Download data from a Windows folder. This folder/directory can be located in your local computer or on your network. This option should be used to process data previously downloaded via FTP.



When selecting downloading data directly from **Data Logger**, a window will pop up asking for the connection mode to the logger. One of these interfaces can be selected to download data: Ethernet (Modbus TCP) interface, USB (device) interface or RS485 (Modbus RTU) interface.

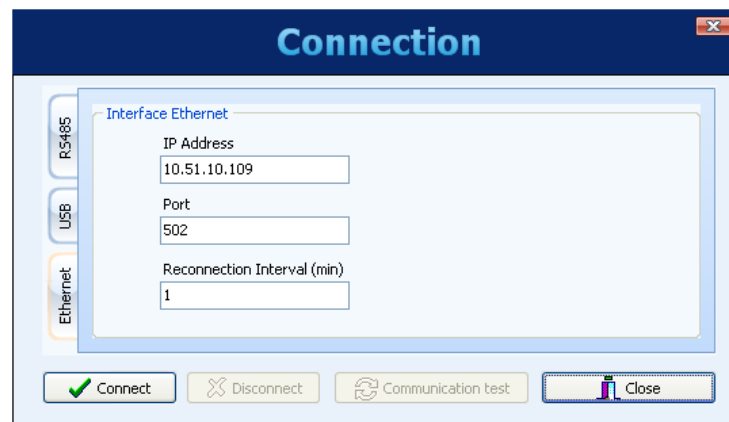

After completing the connection, the next screen will show data logger information.

This screen is very useful, as it helps to assure you are accessing the right logger when downloading via Ethernet/Modbus TCP or RS485/Modbus RTU if there are multiple **Data Loggers** in the network. Next, the **Data Logger** memory location, where logged data is stored (internal flash or SD card), must be chosen.

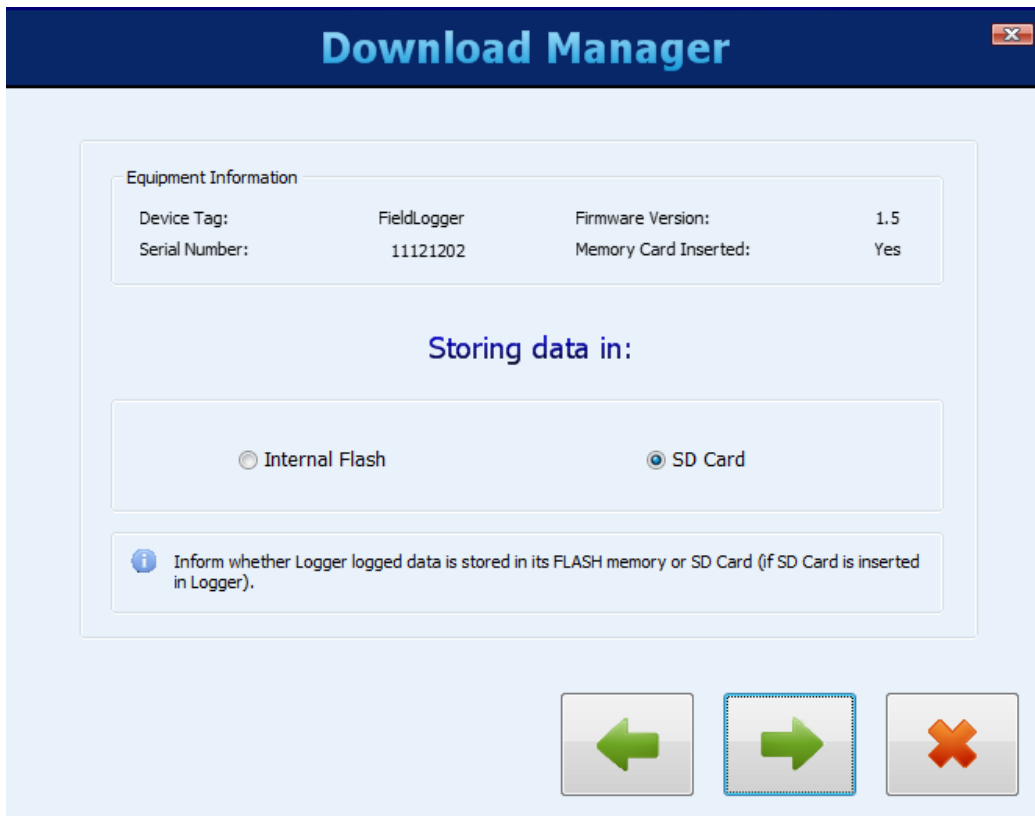

If you select to download data from the SD card, the next screen will ask the desired time period for the recorded data. You can download all data (in case of SD cards, the amount of data can be very large and take a long time to download) or data just from a certain period of time.

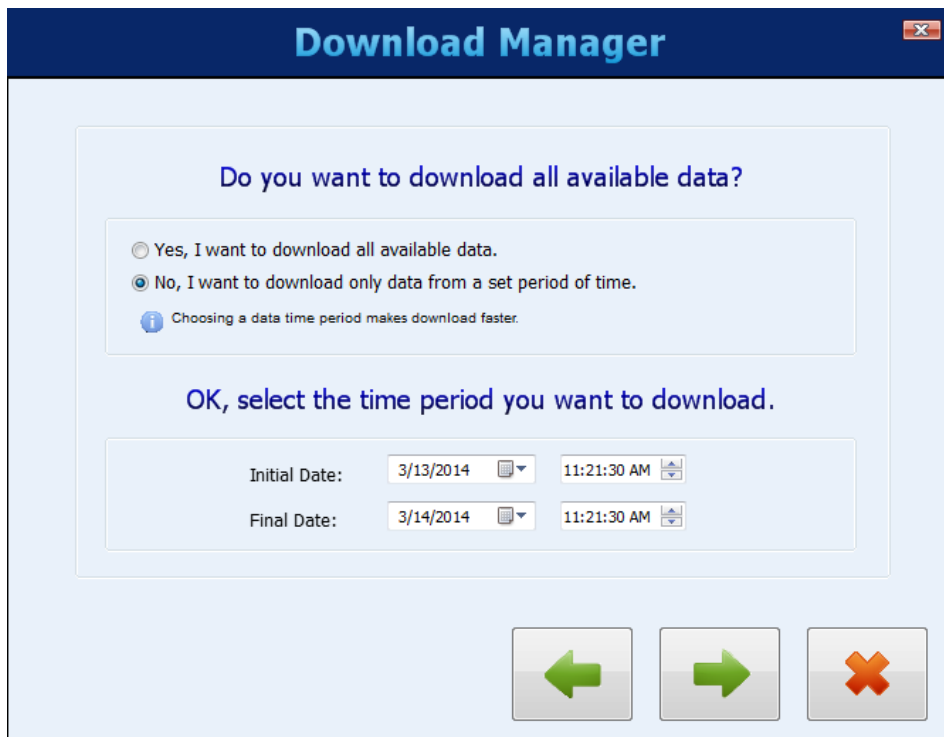

Next, you must confirm the data base folder (folder where all data should be stored in your computer or in the network) and choose whether downloaded data should be deleted from **Data Logger** memory or should be kept.



The screenshot shows a window titled "Download Manager" with a dark blue header. The main content area is light blue and contains the following elements:

- A heading: "Downloaded data will be saved in the folder below."
- A text input field labeled "My database folder:" containing the path "C:\Users\Public\Documents".
- A checkbox labeled "Change my database folder" which is currently unchecked.
- An information icon (i) followed by the text: "The database folder cannot be a root folder. e.g. C:\\".
- A heading: "Do you want to delete data from Logger after download?"
- Two radio button options:
 - Yes, data in Logger memory can be deleted.
 - No, keep data in Logger memory.
- At the bottom, three buttons: a left-pointing green arrow, a right-pointing green arrow (which is highlighted with a blue dashed border), and a red 'X' button.

The next step is to transfer the data from **Data Logger** to data base folder. Click the right green arrow button in order to proceed, downloading will start and a progress bar will be displayed indicating the download progress. Once downloaded, a new screen will be opened for data review/export as described in the "Download Manager" section.

DOWNLOAD MANAGER

The Download Manager allows you to choose the format for viewing the data and to choose the data to be viewed. Using the step-by-step “wizard” format makes it easy and intuitive to complete the download and viewing process.

USING THE STEP-BY-STEP (WIZARD)

First, choose the way data will be processed. The available ways include viewing in table format, viewing in chart format, exporting data to a file and creation of a report with the desired data.

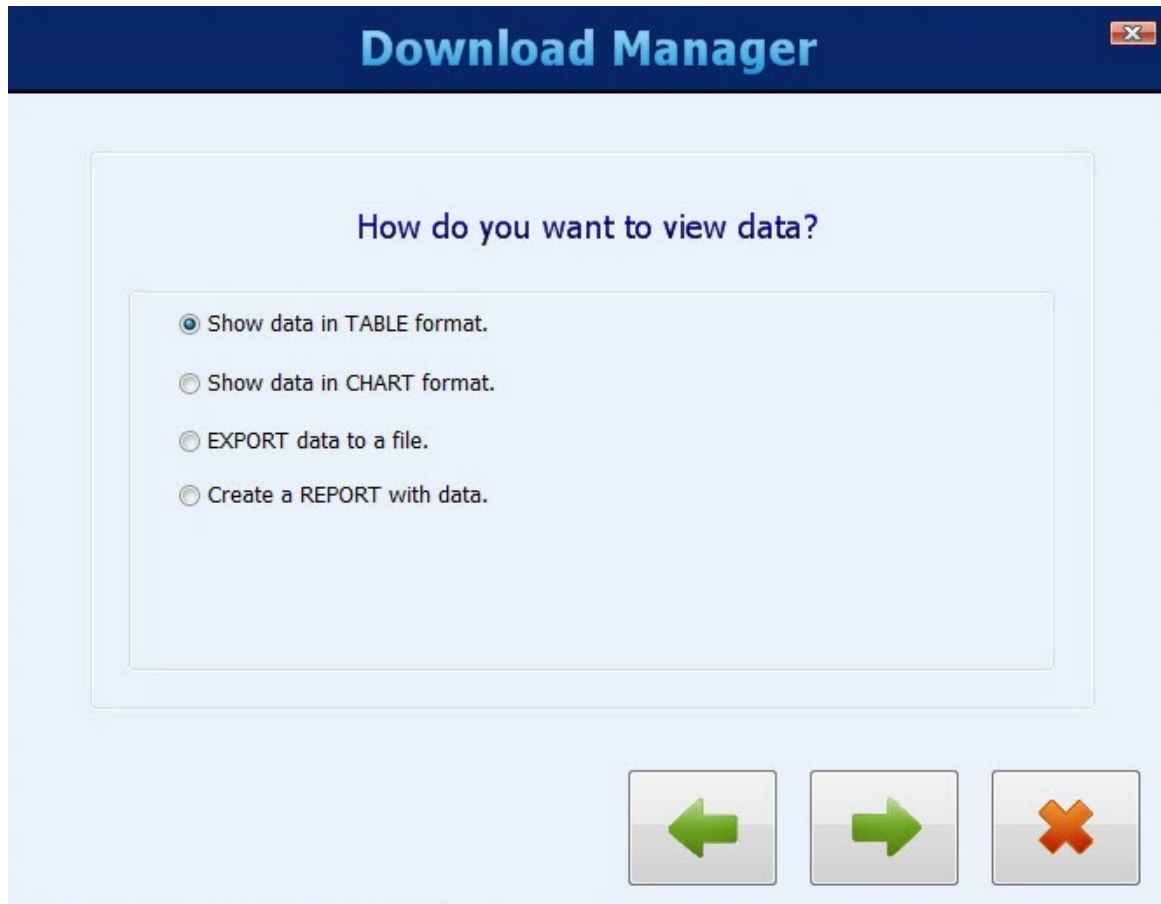

Next, choose the database folder, where data will be saved.

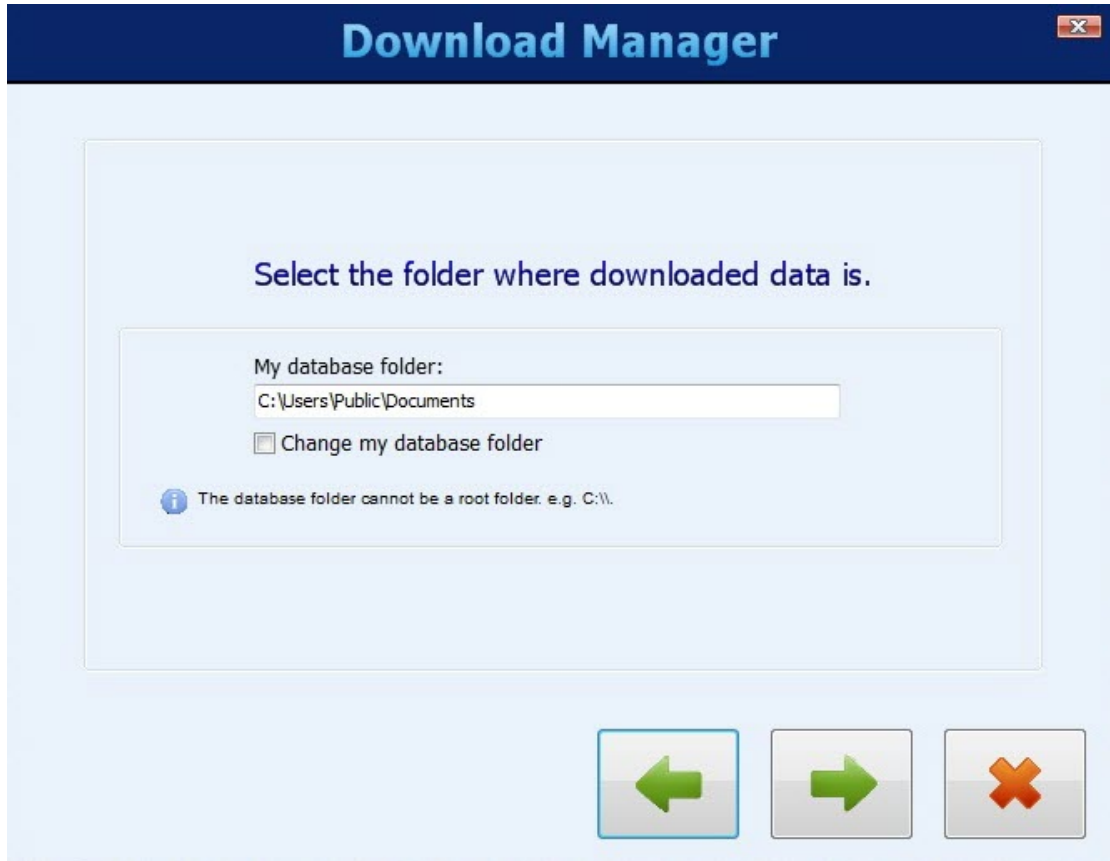

Next, you must select which **Data Logger's** data will be viewed. Selection is done by the logger's serial number.

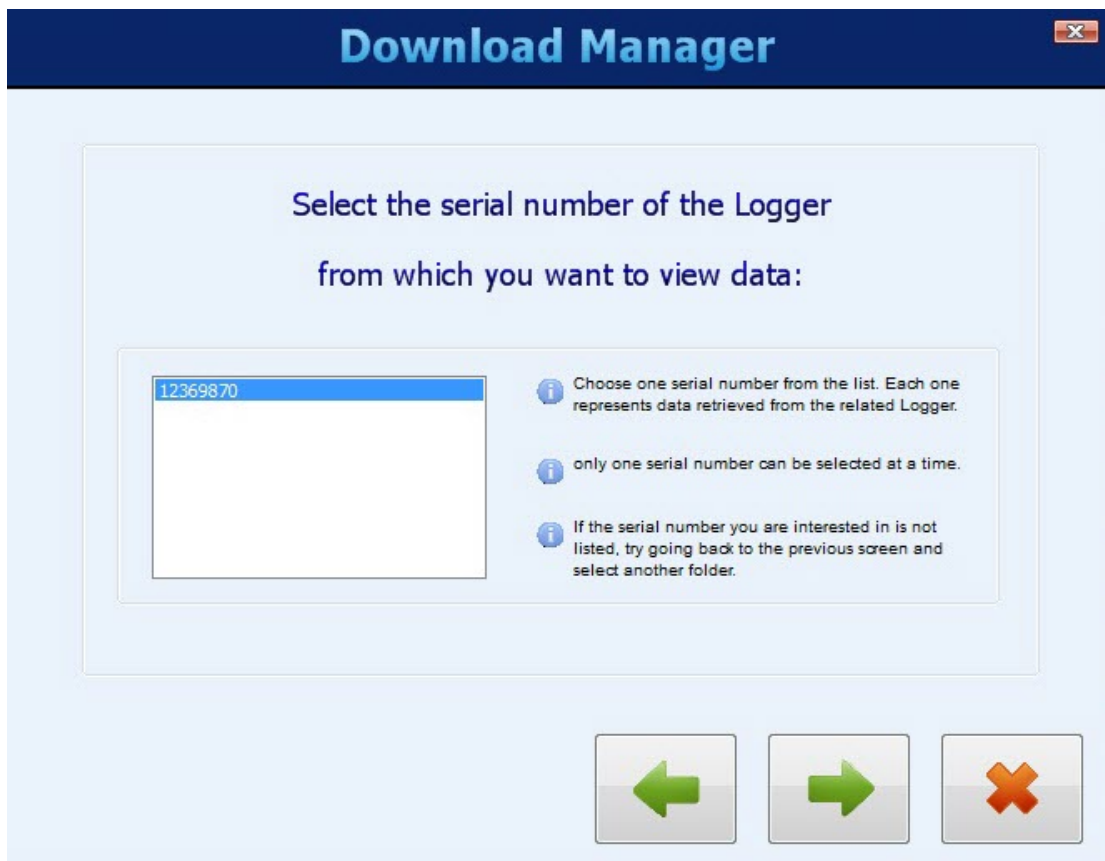

Next, the desired time period must be selected.

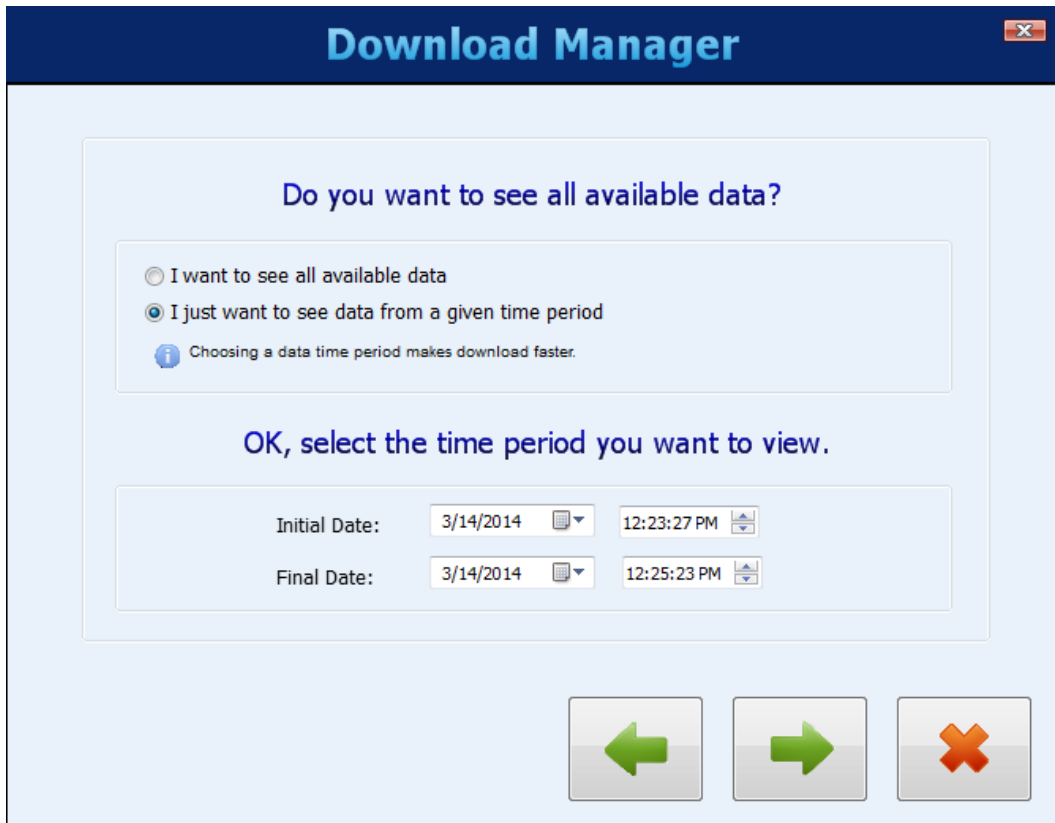

Lastly, choose which channels must be viewed or exported, as well as the number of decimal places for the channels.

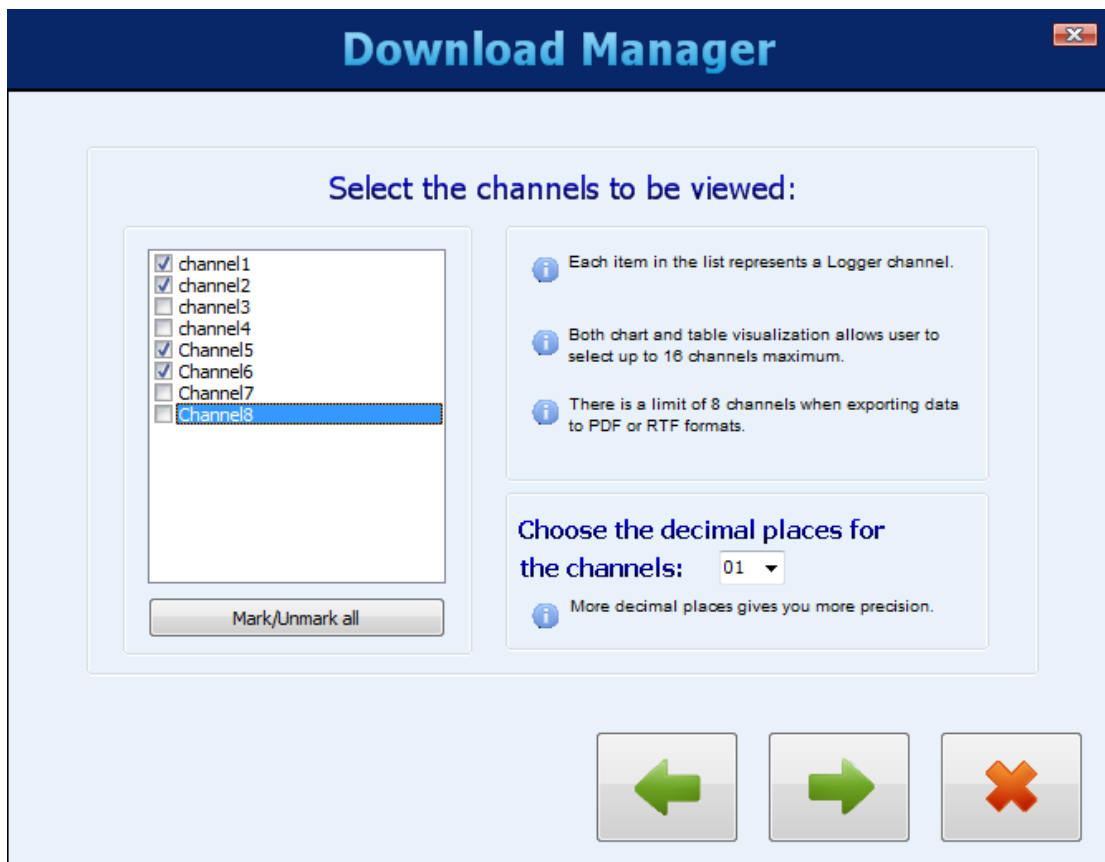

Table Format View

The table view shows data in a table sorted by time, with oldest data first. At the top of the dialog box, there are several navigation buttons that allow the user to move forward or back one screen, or go to the beginning or end of data. In order to view data in this format, no more than 16 channels can be viewed.

	TimeStamp	channel1	channel2	Channel5	Channel6
1	2014/03/14 12:23:27.047100	86.5	-1.0	-1.0	-1.0
2	2014/03/14 12:23:27.147100	86.5	-1.0	-1.0	-1.0
3	2014/03/14 12:23:27.247100	86.5	-1.0	-1.0	-1.0
4	2014/03/14 12:23:27.347100	86.5	-1.0	-1.0	-1.0
5	2014/03/14 12:23:27.447100	86.5	-1.0	-1.0	-1.0
6	2014/03/14 12:23:27.547100	86.5	-1.0	-1.0	-1.0
7	2014/03/14 12:23:27.647100	86.5	-1.0	-1.0	-1.0
8	2014/03/14 12:23:27.747100	86.5	-1.0	-1.0	-1.0
9	2014/03/14 12:23:27.847100	86.5	-1.0	-1.0	-1.0
10	2014/03/14 12:23:27.947100	86.5	-1.0	-1.0	-1.0
11	2014/03/14 12:23:28.047100	86.5	-1.0	-1.0	-1.0
12	2014/03/14 12:23:28.147100	86.5	-1.0	-1.0	-1.0
13	2014/03/14 12:23:28.247100	86.5	-1.0	-1.0	-1.0
14	2014/03/14 12:23:28.347100	86.5	-1.0	-1.0	-1.0
15	2014/03/14 12:23:28.447100	86.5	-1.0	-1.0	-1.0
16	2014/03/14 12:23:28.547100	86.5	-1.0	-1.0	-1.0
17	2014/03/14 12:23:28.647100	86.5	-1.0	-1.0	-1.0
18	2014/03/14 12:23:28.747100	86.5	-1.0	-1.0	-1.0
19	2014/03/14 12:23:28.847100	86.5	-1.0	-1.0	-1.0
20	2014/03/14 12:23:28.947100	86.5	-1.0	-1.0	-1.0

Viewing logged data in table format

Chart Format View

The chart view shows data in a chart format. Moving the mouse over the chart shows the instantaneous values of each viewed channel at the bottom of the screen. No more than 16 channels can be viewed at one time.

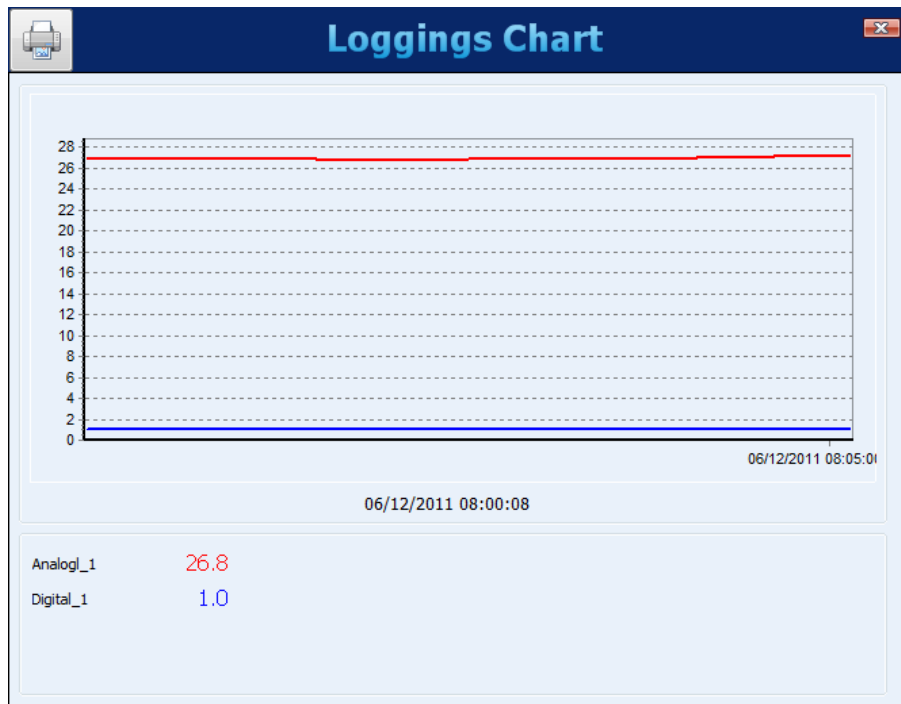

Viewing logged data in chart format

The button on the upper left corner of the screen allows the chart to be printed.

Data Export

To export selected data, click on the “Export” button. A window will appear where you must select the destination folder, the file name and the file extension to be exported.

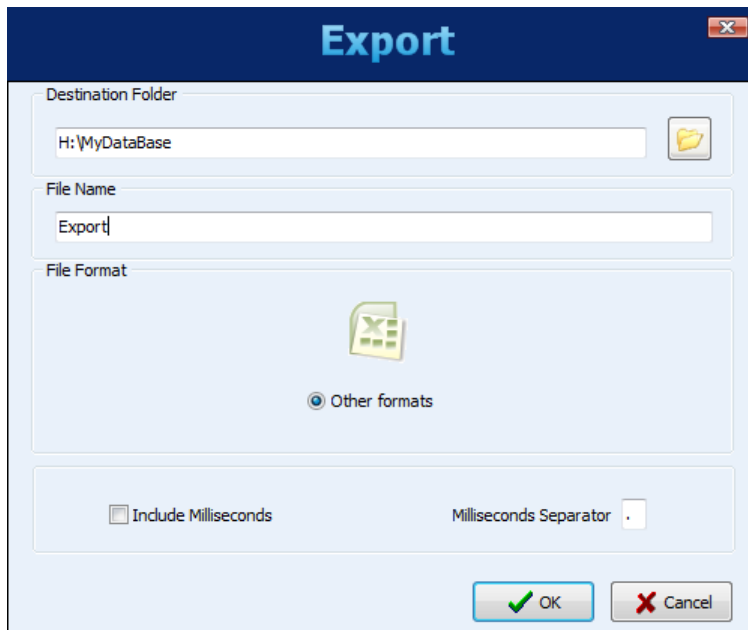

When selecting the “Other Formats” option, a second screen will show up, where it will be possible to choose some parameters related to the chosen format: RTF, HTML, XML, PDF, CSV, SQL, XLSX or DOCX. For exporting in “SuperView” or “FieldChart” format, there is a top limit of 16 channels. For exporting in “PDF” or “RTF” format, there is a top limit of 8 channels

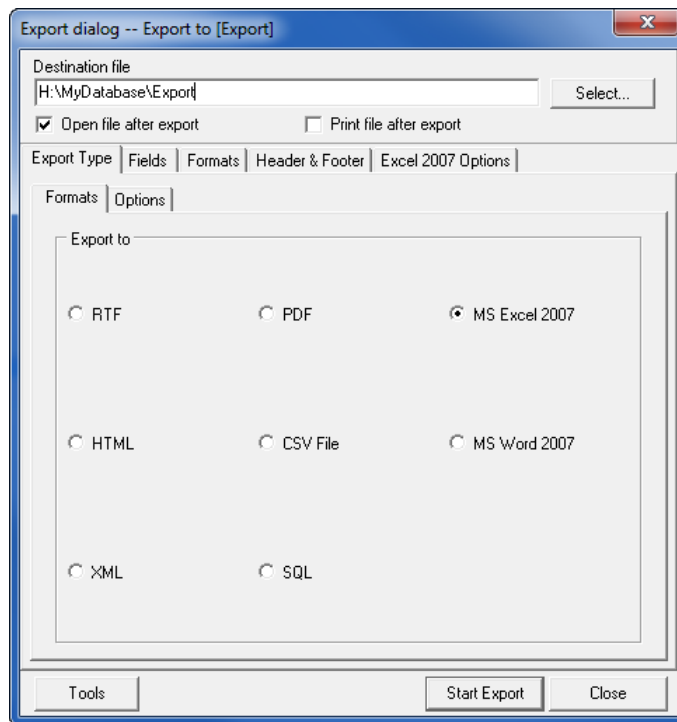

When a successful export is completed, the following window will open.



Report Generation

The file name and destination folder must be entered. Additionally, fields that will be used in the report must be filled in, including report and author names, company name and report title. An image can also be selected to be presented in the report, such as company logo.

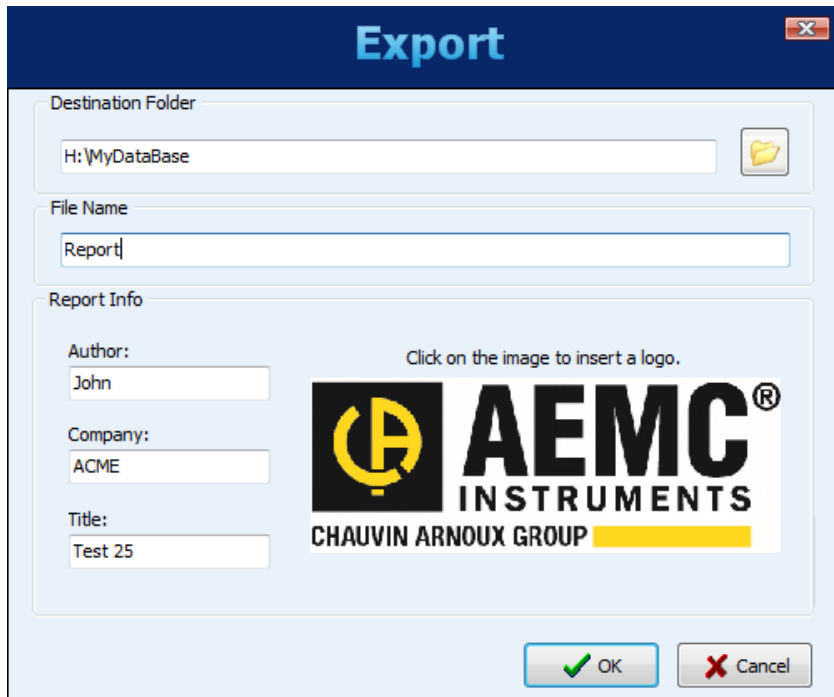

Clicking the “OK” button will bring up a progress bar shown at the bottom of the screen and, when ready, the chart from the desired period will display. A comment field is available to add text to be included with the final report.

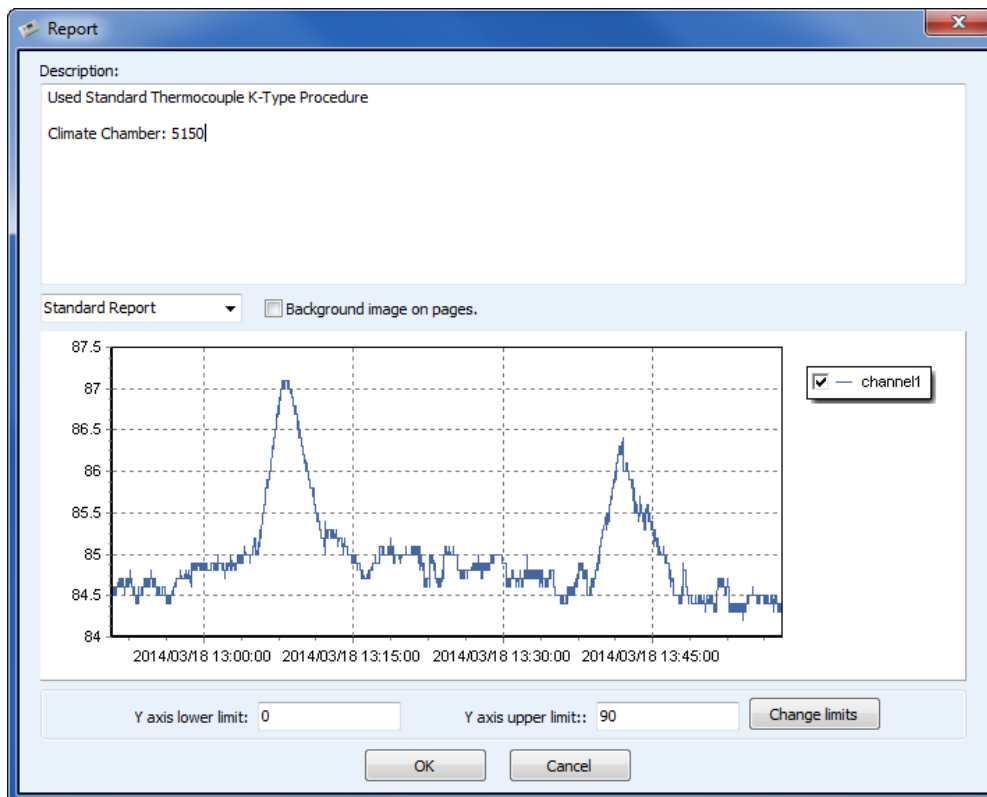

At this point, clicking on the "OK" button will generate and display the report. This report can be printed or saved to a file for later access.

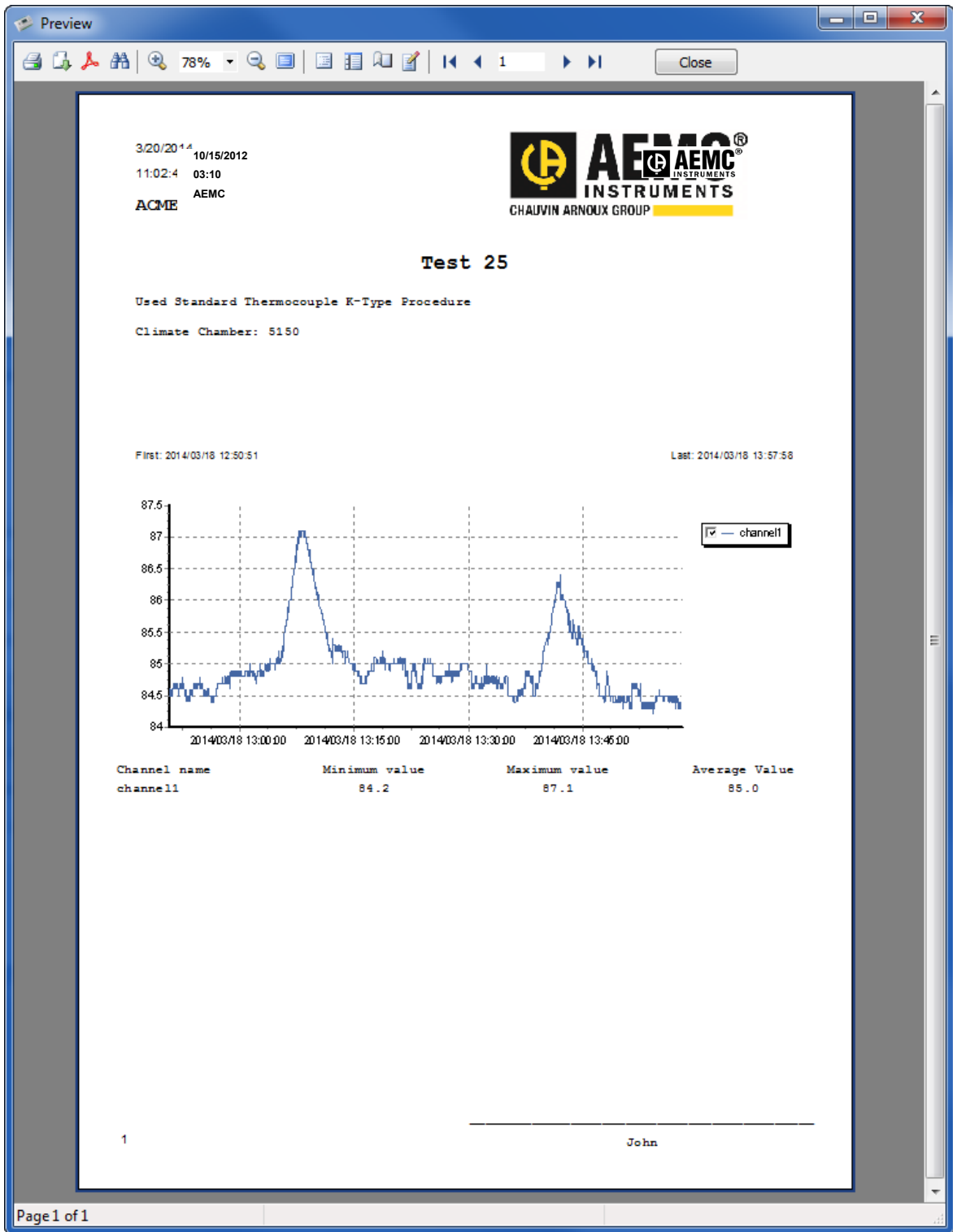

NON STEP-BY-STEP

In the previous versions of the configuration software, this was the only available procedure and it was kept for compatibility reasons.

The proper procedure is to select the source folder of the logged data (logging database). In the "available downloads" field will be displayed all devices that have downloaded data available.

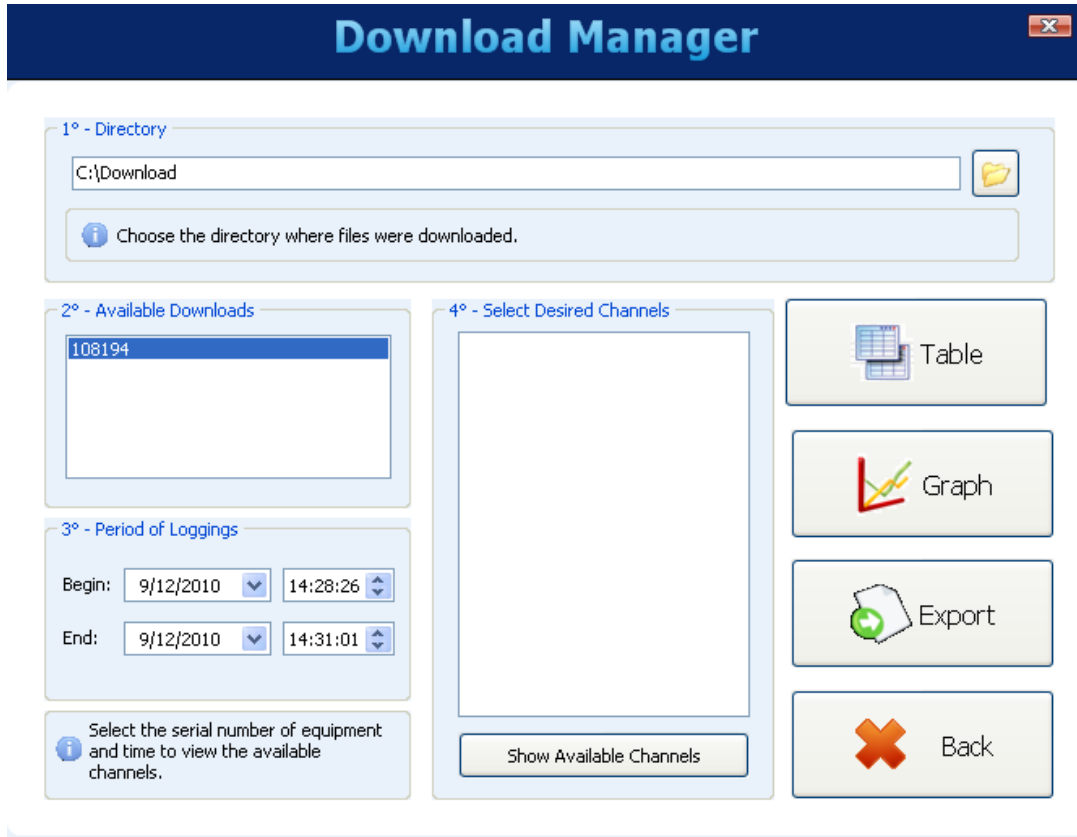

You must choose, through the respective serial number, the equipment that has data of interest at this time. After that, you must define the time period of interest and click on "Show available channels".

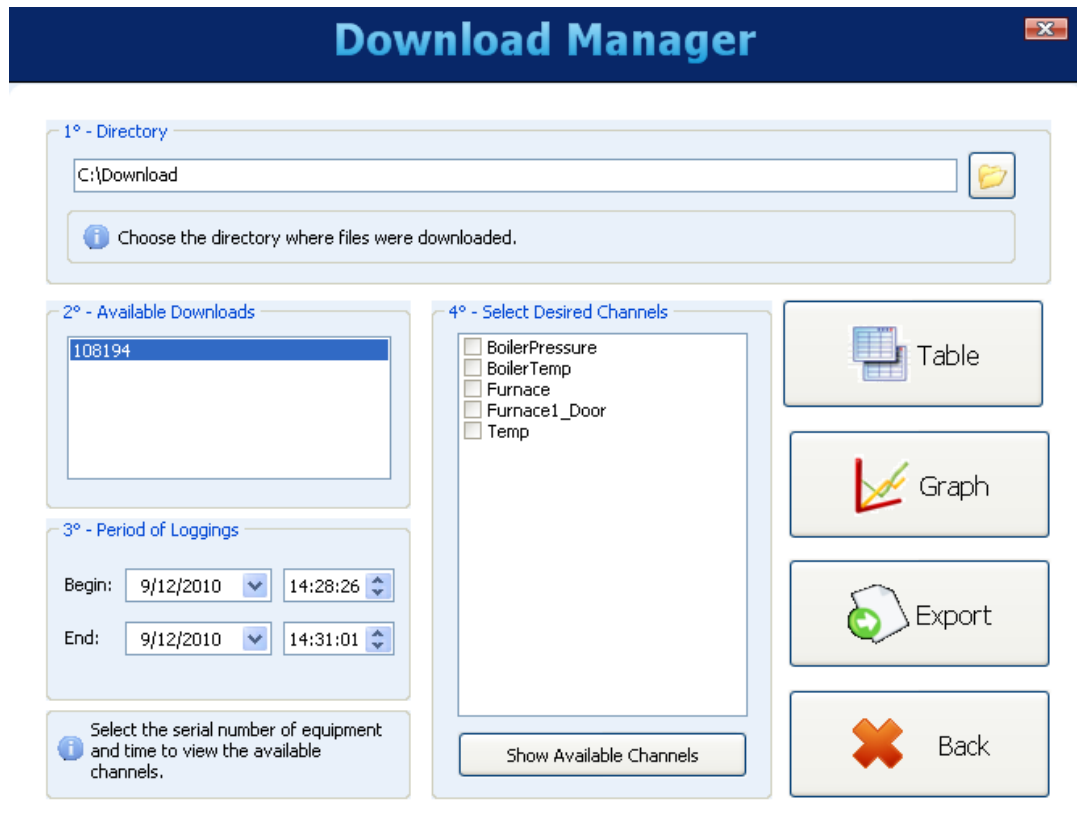

Then, select which channels, among those available, are of interest.

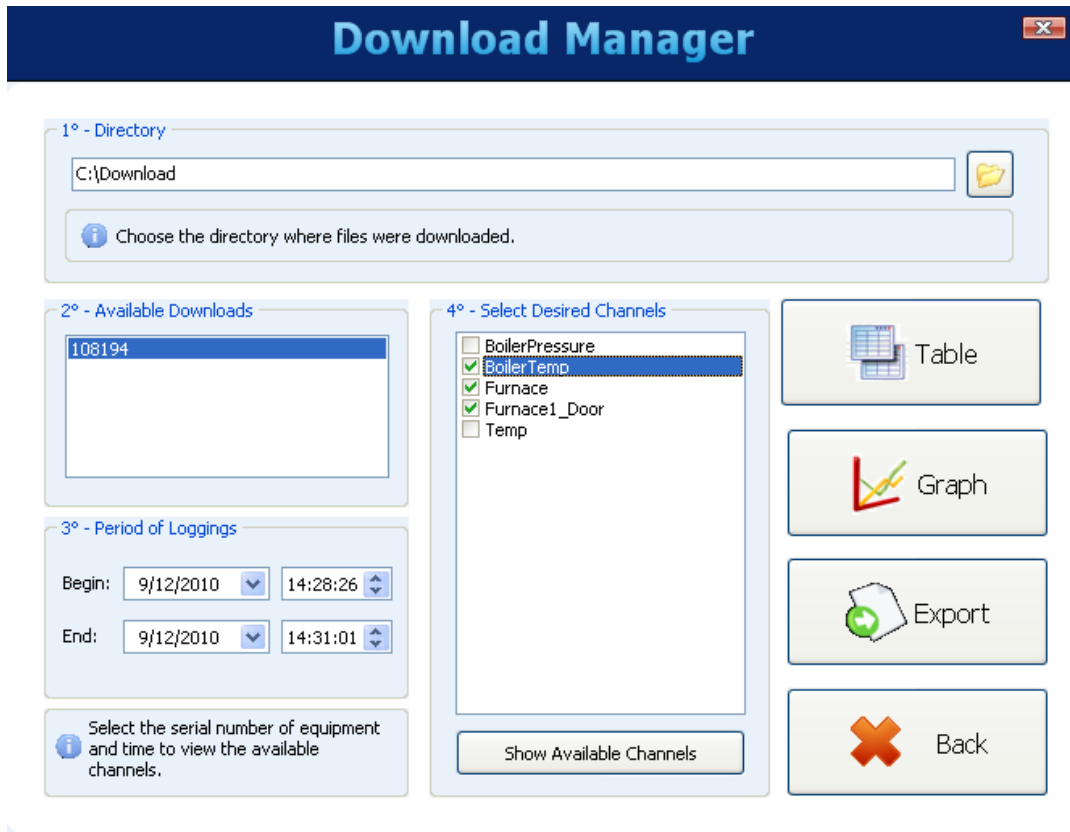

Finally, the chosen channels can be viewed in several ways.

	TimeStamp	BoilerTemp	Furnace	Furnace1_Door
1	2010/12/09 14:28:26.437900	26,077974319458	-1,98537170886993	1
2	2010/12/09 14:28:26.442900	26,077974319458	-1,98537170886993	1
3	2010/12/09 14:28:26.447900	26,077974319458	-1,98537170886993	1
4	2010/12/09 14:28:26.452900	26,077974319458	-1,98537170886993	1
5	2010/12/09 14:28:26.457900	26,077974319458	-1,98537170886993	1
6	2010/12/09 14:28:26.462900	26,077974319458	-1,98537170886993	1
7	2010/12/09 14:28:26.467900	26,077974319458	-1,98537170886993	1
8	2010/12/09 14:28:26.472900	26,077974319458	-1,98537170886993	1
9	2010/12/09 14:28:26.477900	26,077974319458	-1,98537170886993	1
10	2010/12/09 14:28:26.482900	26,077974319458	-1,98537170886993	1
11	2010/12/09 14:28:26.487900	26,077974319458	-1,98537170886993	1
12	2010/12/09 14:28:26.492900	26,077974319458	-1,98537170886993	1
13	2010/12/09 14:28:26.497900	26,077974319458	-1,98537170886993	1
14	2010/12/09 14:28:26.502900	26,077974319458	-1,98537170886993	1
15	2010/12/09 14:28:26.507900	26,077974319458	-1,98537170886993	1
16	2010/12/09 14:28:26.512900	26,077974319458	-1,98537170886993	1
17	2010/12/09 14:28:26.517900	26,077974319458	-1,98537170886993	1
18	2010/12/09 14:28:26.522900	26,077974319458	-1,98537170886993	1
19	2010/12/09 14:28:26.527900	26,077974319458	-1,98537170886993	1
20	2010/12/09 14:28:26.532900	26,077974319458	-1,98537170886993	1

Viewing logged data in table format

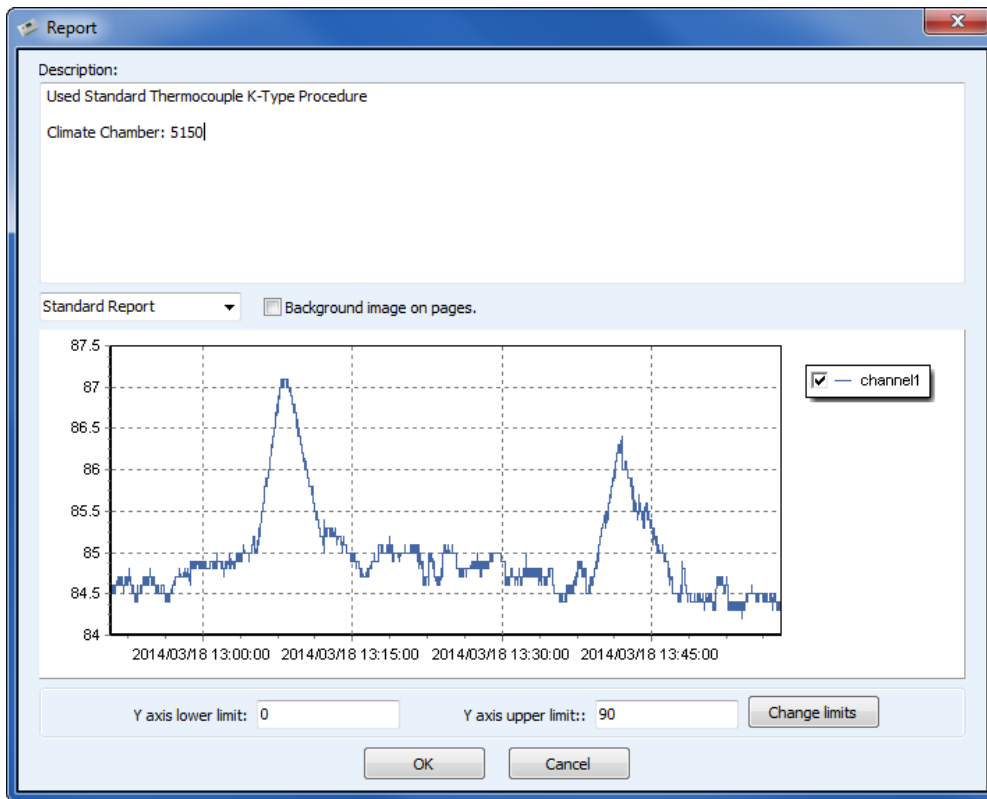

Viewing logged data in chart format

There is a button on the upper left corner that allows users to print the chart.

To export the selected data, you must click on the "Export" button. After a prior processing, a window will appear where you must select the destination folder, the file name and the file extension to be exported.

The screenshot shows an "Export" dialog box. The title bar is dark blue with the word "Export" in white. The main area is light blue and contains several sections:

- Destination Folder:** A text box containing "H:\MyDataBase" and a folder icon button to its right.
- File Name:** A text box containing "Export".
- File Format:** A section with a grid icon and a radio button selected for "Other formats".
- Include Milliseconds:** A checkbox that is currently unchecked.
- Milliseconds Separator:** A text box containing a period ".".

 At the bottom right, there are two buttons: a green "OK" button with a checkmark and a red "Cancel" button with an X.

Since configuration software version 1.50, the exporting process was improved, providing more control over the fields and formats of the exportation. The basic window with the format choice became different:

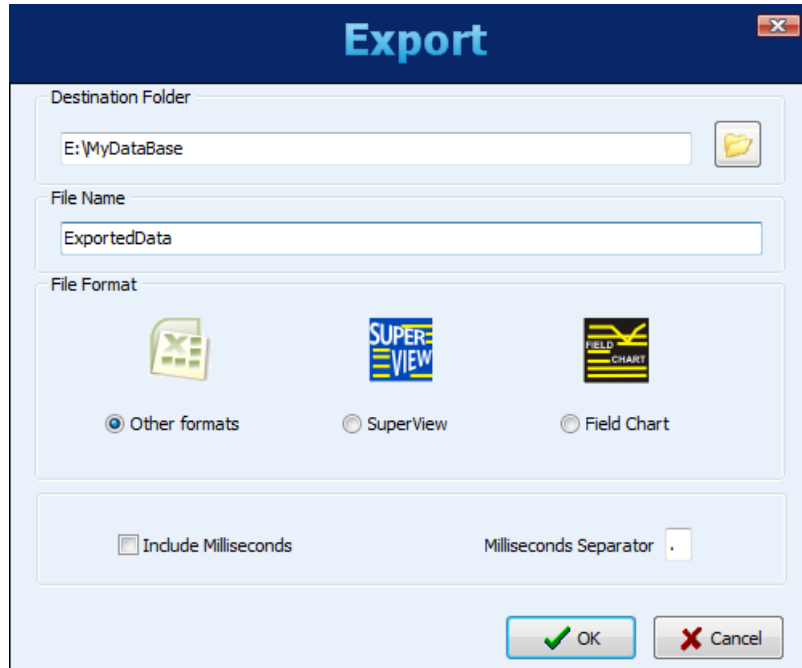

Whenever choosing the “Other formats” options, a second window pops up, allowing the choice of the type of the file and many other options.

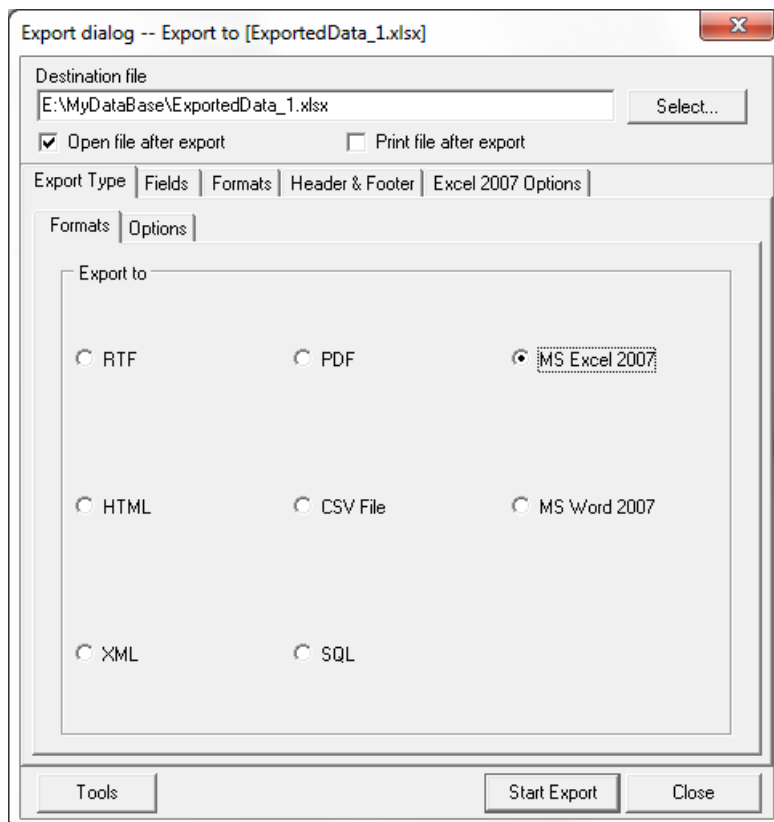

Upon completion of the export process, a window is displayed showing its success.



PREFERENCES

Using the Preferences screen, you can change the way the software application is started, adapting it to the procedure that is desired. The configurable options are:

- **Do Nothing:** Normal behavior of the software. You will see the initial application screen where you may select what tasks to perform.
- **Read Configuration:** The application will automatically open the connection screen and then execute reading the parameters configured in the data logger connected.
- **Open Last Configuration:** The application will read the last used configuration file and show it in the configuration screen, without connecting to the logger. If there is no last file, the software will indicate the error and display the initial screen.
- **Download Logging Data:** Will open the screen where you can choose what type of download will be performed.
- **Open Diagnostics Screen:** It will open the connection screen, and read from the connected logger.

On this screen you can also change the language that the software will adopt as default.

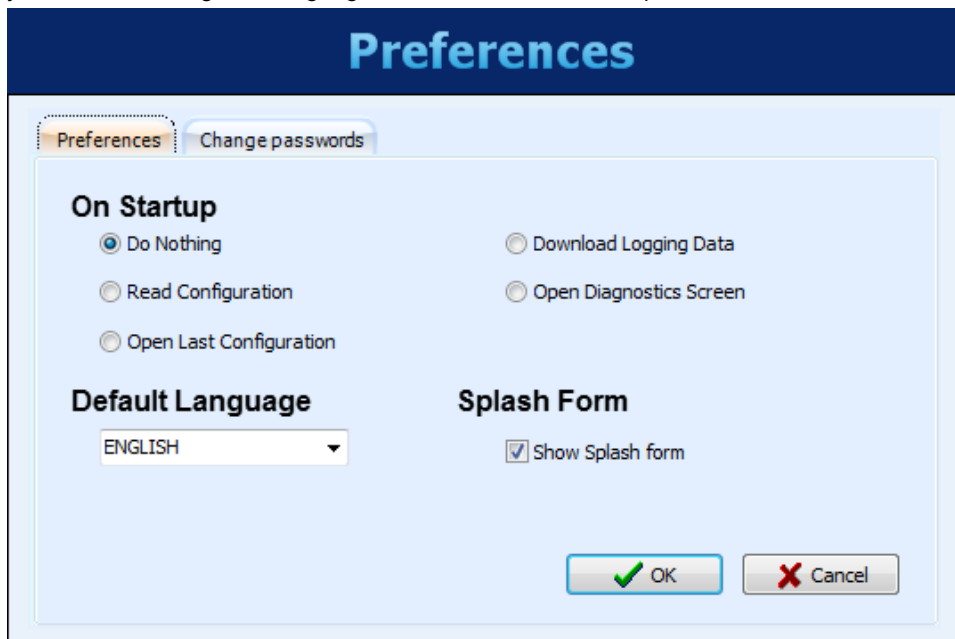

PASSWORD PROTECTION

It is possible to protect the access to the equipment by using passwords. You can register a password for configuration and another one for data download. First one protects the equipment from undesired changes in its configuration and the second one does not allow data to be downloaded by unauthorized people. In order to remove the need of a password to access the equipment, simply leave the new passwords fields blank.



This property is available since firmware version 1.40. **Data Logger** leaves factory with no passwords set.

Find Quality Products Online at: www.GlobalTestSupply.com sales@GlobalTestSupply.com

COMMAND-LINE OPERATION

The **Data Logger** Configurator has the ability to be called with “command-line” parameters, which means it can be used to download and export data by other applications.

It is advisable to create a batch file (.bat) to help organize the desired parameters. Once this batch file is done, it can be called (executed) from any other software in order to run the desired tasks, which include:

- Download data from the device.
- Get data from a folder where data has already been downloaded to.
- Export downloaded data to a file.
- Export data from the **Data Logger** data base to a file.
- Create a report with logged data.

Some parameters are sent in the command-line, others are read by the INI files of the Configurator. So, it is important that you perform the desired action with the Configurator at least once before trying to do it by the command-line. It assures you that the method you are about to use works properly, and it saves the needed parameters in the INI file as well, so they can be used later.

Parameter order is important! Do not try to use them in any order but the one shown here.

Parameter examples are shown inside quotation marks (“”). Do not use quotation marks in the real file.

BATCH FILE

The batch file is exactly the same of those ancient DOS batch files. Its name must have no more than 8 characters, a dot (.) and 3 more for its extension (“bat”).

In the file, we separate the parameters in four parts:

1. PART1 – Action type
2. PART2 – Connection mode
3. PART3 – Action parameters
4. PART4 – Export parameters

All parameters are separated by semicolons.

ACTION TYPE

The following actions are allowed:

- “1” to download and export data.
- “2” to export data from the data base.
- “3” to download data without exporting it.

CONNECTION MODE

The connection mode can be:

- “1” to connect by Ethernet/Modbus TCP. In this case, it will read the port and reconnection time from the Configurator “INI” file, which means that it should have been done before in the Configurator “normal” operation. This option requires the IP address as an additional parameter. For software version 1.30 and higher, a port number must be also included and a time out in milliseconds. Example: “1;10.51.10.78;502;3000;”
- “2” to connect by the USB cable. This option requires the COM port as an additional parameter. Example: “2;3;”
- “3” to connect by the RS485/Modbus RTU interface. In this case, it will read the baud rate, parity, stop bits and timeout from the Configurator “INI” file, which means that it should have been done before in the Configurator “normal” operation. This option requires the COM port and the Modbus address as additional parameters. Example: “3;2;7;”
- “4” getting data from a folder. This option should be used when data was already downloaded from the **Data Logger** through a USB flash drive, FTP or when reading directly from the device SD card (plugged in your computer). This option requires the folder path as an additional parameter (the folder with the device serial number must be included). Important: there must be no blank spaces in the path! Example: “4;E:\11097831;”

When the chosen Action is “2” (export only, no download), the parameter “NULL” must be used to indicate that no connection is needed. Example: “NULL;”

ACTION PARAMETERS

These parameters are directly related to the option chosen for the Action. The data base folder is read by the Configurator INI file, so be sure to set it in the software before trying to use it by the command-line.

- For Action “1”, we need the following additional parameters (their order should be respected):
 1. Data source. It can be: “0” when downloading data from device internal flash, “1” when downloading from device SD card and “2” when getting data from a folder in the computer/network (connection mode “4”).
 2. Time period. It can be: “0” to download all its data or any other integer “X” number to download data from the last “X” days.
 3. Erase option. It can be: “0” will keep data in the original memory, “1” will erase downloaded data from the original memory.
 4. Serial number. Device serial number should be placed here.
 5. Download password (needed for firmware versions 1.40 or higher). Registered password for downloads should be placed here. A “NULL” string must be used if there no password is used.
 - Example: “0;0;1;11097831;1234;”
- For Action “2”, we need the following additional parameters (their order should be respected):
 1. Serial number. Device serial number should be placed here.
 2. Time period. It can be: “0” to download all its data or any other integer “X” number to download data from the last “X” days.
 - Example: “11097831;3;”
- For Action “3”, we need the following additional parameters (their order should be respected):
 1. Data source. It can be: “0” when downloading data from device internal flash, “1” when downloading from device SD card and “2” when getting data from a folder in the computer/network (connection mode “4”).
 2. Time period. It can be: “0” to download all its data or any other integer “X” number to download data from the last “X” days.
 3. Erase option. It can be: “0” will keep data in the original memory, “1” will erase downloaded data from the original memory.
 4. Download password (needed for firmware versions 1.40 or higher). Registered password for downloads should be placed here. A “NULL” string must be used if there no password is used.

Example: “1;7;0;1234”

EXPORT PARAMETERS

These parameters are related to file export. The target folder for the exported files, as well as the Author, Company and Title fields for the reports are read by the Configurator INI file. Be sure to set it in the software before trying to use it by the command-line.

- File name with no extension or blank spaces.
- File type. Use “1” for PDF, “2” for CSV, “3” for RTF, “4” for XLS, “5” for SuperView, “6” for FieldChart and “7” for creating a report.
- Number of decimal places to be used for channels values. Valid values: 0 to 6.
- Example: “test_report;2;1;”

When the chosen Action is “3” (download only, no export), the parameter “NULL” must be used to indicate that no export is needed. Example: “NULL;”

DATA LOGGER OPERATION

ANALOG INPUTS

The **Data Logger** has eight analog input channels. The types of accepted inputs and sensors are the following: thermocouples J, K, T, E, N, R, S and B; RTDs Pt100 and Pt1000; DC 0 to 50mV; 0 to 60mV; 0 to 20mV; -20 to 20mV; 0 to 5V; 0 to 10V; 4 to 20mA and 0 to 20mA.

The accuracy of these signals is described in the *Specifications* section. The connection of these signals is described in the *Connections and Installation* section.

These inputs incorporate an analog/digital converter (A/D) with 24 bit resolution and accuracy. In the selected scan interval, all of the analog channels enabled will be read. The ratio between the number of channels enabled and the scan time is limited up 1000 readings per second. Therefore, one channel can be read 1000 times per second, two channels at 500 times per second and so on. So, the A/D converter will work faster in order to cope with the desired channels scan.

The A/D converter has a better signal-noise ratio when operating at low speeds (longer scan intervals), as well as higher effective resolution and better immunity to noise from the power line. It is recommended to use the longest possible scan interval for the application to obtain better results from the analog inputs. It is recommended to disable all the channels that are not necessary, because the increase in the number of enabled channels causes the A/D converter to work faster in order to cope with the scan rate. Each type of input signal has a valid range of measurement (detailed in the *Specifications* section of this manual). However, the logger usually can measure signals that exceed the limits of this range. How far beyond the valid range will depend on the type of the configured input and may vary from device to device.

The following table outlines what to expect depending on the signal applied at the input, for each type.

INPUT TYPE	CONDITION OF INPUT SIGNAL	INDICATION
Thermocouples: J, K, T, E, N, R, S and B	Within the range	Value read from input
	Open thermocouple	Value of configured error
	Just above the upper limit	Value read from input *
	A little below the lower limit	Value read from input *
	Far above the upper limit	Value of configured error
	Well below the lower limit	Value of configured error
Pt100 and Pt1000	Within the range	Value read from input
	Pt100/Pt1000 with one or more wires disconnected	Value of configured error
	Just above the upper limit	Value read from input *
	A little below the lower limit	Value read from input *
	Far above the upper limit	Value of configured error
	Well below the lower limit	Value of configured error
Voltage (mV): 0 to 50mV, 0 to 60mV, 0 to 20mV and -20 to 20mV	Within the range	Value read from input
	Disconnected signal	Value of configured error
	Just above the upper limit	Value read from input *
	A little below the lower limit	Value read from input *
	Far above the upper limit	Value of configured error
	Well below the lower limit	Value of configured error
Voltage (V): 0 to 5V and 0 to 10V	Within the range	Value read from input
	Disconnected signal	Value close to 1.8V
	Just above the upper limit	Value read from input *
	A little below the lower limit	Value read from input *
	Far above the upper limit	Value of configured error
	Well below the lower limit	Value of configured error
Current (mA): 4 to 20mA	Within the range	Value read from input
	4 to 20mA: Value of configured error	

INPUT TYPE	CONDITION OF INPUT SIGNAL	INDICATION
	Just above the upper limit	Value read from input *
	A little below the lower limit	4 to 20mA: Value read from input * 0 to 20mA: it is not possible to decrease besides the inferior limit
	Far above the upper limit	Value of configured error
	Far below the lower limit	4 to 20mA: Value of configured error 0 to 20mA: it is not possible to decrease besides the inferior limit

(*) **Note:** The indication of the analog channel is beyond the limits specified for the selected input type. Accuracy is not guaranteed in this condition.

Table 01 - Measurement and indication of the **Data Logger** input types

You must choose the digital filter to be used for each channel in use. Valid values between "0" (no filter) and "20" (maximum filter) are allowed. The higher the value of the filter, the lower the fluctuations read in the input, and the slower the channel responds to changes in the input signal.

There is also the ability to insert up to 10 points for each channel in order to correct distortions in the reading of these channels at these points. This is a "custom calibration," feature because it allows you to adjust the indication at the desired points, resetting the error at these points to zero. Between the inserted points, the adjustment is done linearly, depending on the entered values. It is important to point out that the insertion of custom calibration points is optional, available only to those who want to adjust the indication with a local standard. The **Data Logger** already comes fully calibrated from the factory.



Whenever you change the input type, make sure that the custom calibration points of the previous input are deleted!

For each channel, you must assign a unique name (tag), which will be used to reference the channel. You should also choose the type of input (sensor) that will be connected to that channel. In addition, you can assign the unit for the measured value: when temperature sensors (Pt100, Pt1000 or thermocouples) are involved you must choose between Centigrade (°C) and Fahrenheit degrees (°F); when linear sensors (voltage or current) are involved, you can type the desired unit.

In the case of linear input types, you can choose what the indication range of the channel will be, in other words, what the channel will indicate when the input is at its minimum value and at maximum value (minimum and maximum values determine the working range of the **Data Logger** for the selected input type). Example: selecting the 4-20mA input type connected to a 0 to 2 bar pressure transmitter, we must choose the minimum value in the configuration of the input "0.0" and the maximum value "2.0". All the available resolution and accuracy will be contained in the selected range.

When using any equipment on analog inputs that are connected to the power network (for example: thermocouples or voltage simulator), it is recommended not to use the USB interface for communicating due to the possible occurrence of noise and offsets in readings due to the influence of the USB cable connection, most likely associated with ground loops.

DIGITAL INPUTS/OUTPUTS

The **Data Logger** has eight digital channels that can be individually configured as inputs or outputs.

Channels configured as inputs, if enabled, may be logged in memory, used as alarm inputs and as operands of virtual channels. Channels configured as outputs are "open-drain" type and may be triggered by alarms or triggered via external Modbus commands.

The digital inputs have two (floating point) values associated with their logic states during the **Data Logger** configuration. Depending on the input's current logic state ("0" is equivalent to a low voltage or a closed contact in the input; "1" is equivalent to a high voltage or an open contact in the input), this corresponding value is used by the virtual channels, alarms and logs.

The digital outputs configured to be controlled by the alarms cannot be triggered by external Modbus commands. Likewise, the outputs configured to be controlled by external Modbus commands cannot be used by the alarms.

The outputs controlled by external commands can be used, for example, as control outputs or alarm outputs of SCADA software or PLCs.



The digital inputs/outputs terminals are not isolated from the analog inputs terminals!
Do not use analog and digital signals coming from the same voltage source; this will cause the logger to malfunction.

COUNTING

From firmware version 1.10 on, it is possible to perform pulse counting at the digital inputs of the **Data Logger**. Counting resolution is 32-bit, which means that each input can count from "0" up to $(2^{32} - 1) = 4294967295$. When the maximum value is reached, the next counted pulse will cause a roll-over and will reset the counting to zero.

The counting values can be accessed from Modbus registers (see the "Data Logger – Modbus" document) and can also

Counting values can be zeroed by writing it in the related Modbus registers.

Counting values are persistent and will remain even when Data Logger is turned off. When it is turned on again, counting continues with the next value.

OUTPUT RELAYS

The **Data Logger** has two relay type outputs (**RL1** and **RL2**) which can act as **Alarms** or **Digital Outputs**.

When configured as Alarms, they act according to the configuration adopted for the alarms. When configured as Digital Outputs, they are controlled remotely via Modbus commands (via RS485, USB or Ethernet).

RS485 INTERFACE

The **Data Logger** RS485 interface can be enabled or disabled. When disabled, it does not impact the traffic that may exist on the data bus. When enabled, it can be configured to operate as a Modbus RTU master or as a slave.

Slave

When operating as a Modbus RTU slave, the logger makes the channel values available to be accessed by the master on the Modbus network, either being a PLC, a SCADA application or any other device.

Master

When operating as a Modbus RTU master, it allows data from other devices on the bus to be read by the **Data Logger** and used in recording, alarms, virtual channels or simply made available via another interface such as Ethernet, for example. See the "Remote Channel" section for details of how to implement a Modbus RTU network with the **Data Logger** in the master role.

It can work as a gateway between a Modbus TCP network and a Modbus RTU network. This way, all Modbus TCP requests received by **Data Logger** with an identifier other than "255" will be forwarded to the Modbus RTU network, assuming that this request was addressed to a slave located in this network. Modbus TCP requests received by a **Data Logger** with an identifier equal to "255" will be answered by the **Data Logger** itself. This feature must be enabled in the Configurator software.

The RS485 interface can be configured to operate at the following speeds (baud rates): 1200, 2400, 4800, 9600, 19200, 38400, 57600 and 115200. Moreover, it can be configured to operate with one or two stop bits, and in even, odd or parity.

Further details about the implementation of a Modbus devices network via RS485 can be found in "RS485 & RS422 Basics", available in the product CD.

D1	D	D+	B	Bidirectional data line.	Terminal 50
D0	D	D-	A	Inverted bidirectional data line.	Terminal 49
C				Optional connection that improves communication performance.	Terminal 48
GND					

AUXILIARY RS485

The **Data Logger** auxiliary RS485 interface is in the DB9 connector which is located under the **Data Logger** cover. Its main function is to provide data to the **Data Logger** HMI, but from firmware version 1.20 on, it can be used as a generic interface, acting as a Modbus-RTU slave. Some further details can be seen in "HMI (Human-Machine Interface)" section.

As an interface to the HMI, it must be configured with baud rate 115200 bps, one stop bit and no parity.

As a generic interface, it can be configured to operate in the following baud rates: 1200, 2400, 4800, 9600, 19200, 38400, 57600 e 115200. Besides that, it can be configured to operate with one or two stop bits and with even, odd and no parity.

D1	D	D+	B	Bidirectional data line.	Pin 4
D0	D	D-	A	Inverted bidirectional data line.	Pin 8
C				Optional connection that improves communication performance.	Pin 7
GND					

REMOTE CHANNELS



Function not available in models "**Data Logger – USB, 512k logs, RS485**" and "**Data Logger – USB, 512k logs, RS485, 24 V**".

The **Data Logger** can act as a master on a Modbus RTU network (please check the RS485 interface configuration) to be

The **Data Logger** starts reading the channels in the same order that they were created at configuration time. It goes on reading all channels, respecting the times between commands, until it has read them all. When the scan interval has elapsed, it restarts the readings of all remote channels. In case the channels scan takes longer than the settled scan interval, it restarts the channels reading immediately.

If the slave takes longer than the configured time out to respond, this will be considered a communication error. In the same way, response packets with invalid CRCs or with times between bytes greater than those specified in the Modbus standard will be considered communication errors. In the occurrence of a communication error in a remote channel reading, it tries again until the configured number of attempts has been reached. If the error persists, the error value configured for the channel is assumed.

The communication flow can be monitored by the **Data Logger** Tx and Rx LEDs. Whenever a command is sent to a slave, the Tx led turns ON. When the slave responds to the command, the Rx led turns ON. This way, during a normal **Data Logger** scan of some slaves, Tx and Rx LEDs should flash alternately as many times as the number of the configured remote channels.

From firmware version 1.50 on, it is possible to assign a number of decimal places directly to the remote channels, therefore it is not necessary to use virtual channels to view a remote channel which has one or more decimal places. For example, reading a temperature from a Modbus slave that has a decimal place in integer format, e.g. multiplied by "10" (25.7°C is read as 257), it is now possible to read "25.7" directly. In older versions, you had to create a virtual channel that received this remote channel and divided its value by 10 to restore the original temperature value. This virtual channel could then be used to replace the remote channel for logging, alarms or simple indication.

VIRTUAL CHANNELS

There are up to 128 virtual channels available in the **Data Logger**. These channels are the result of logical or mathematical operations. Depending on the selected operation, one or two operands will be necessary, defining that the operands are always other channels (analog, digital, remote or even virtual). All operands are in "floating point" format, which allows a greater precision in the calculations by allowing use of several decimal places.

It is possible to "chain" several operations, causing the outcome of an operation to be the operand of another. If a channel used as an operand is in an error condition, the resulting virtual channel will also assume an error value.

Constant values can be used through the "Constant" operation, where a value chosen by the user may be assigned to a virtual channel.

The following operations are available and can be used:

Operation	Number of Operands	Function
Constant	1	Assigns a value to the virtual channel. Example: VC = 123.67
Addition	2	Receives the addition from two channels. Example: VC = C1 + C2
Subtraction	2	Receives the subtraction from two channels. Example: VC = C1 - C2
Multiplication	2	Receives the multiplication from two channels. Example: VC = C1 * C2
Division	2	Receives the division from two channels. Example: VC = C1 / C2
Logical "And"	2	Receives "0" if at least one of the two channels is zero. It receives "1" if both channels are different from zero.
Logical "OR"	2	Receives "0" if at least one of the two channels is not zero. It receives "0" if both channels are equal to zero.
Logical "Exclusive OR"	2	Receives "1" if only one of the two channels is not zero. It receives "0" if both channels are equal to zero or if both are different from zero.
FloatToFloat	2	Transforms two 16-bit values in a "float". Typically used when reading two Modbus registers (remote channels) from other device that, when combined, represent a floating point value.
Int32ToFloat	2	Transforms an integer 32-bit signaled value in a floating point value. The allowable range for the integer value (operand) is from -16777215 to 16777215. Values outside this range will truncate.
Square Root	1	Receives the square root from the operand (source channel).
Exponentiation	2	Receives the result from the first high channel to the second channel. Example: VC = C1 ^{C2} . The value of the exponent is limited to the range of -120 to 120, and must be an integer (the decimal part shall be disregarded).
Count ¹	1	Copies the current counting value of the selected digital channel (operand) to this virtual channel. It uses only 24 bits, which means it can count up to "16777215" (most significant byte of the counting's ignored).

		current channel value related to the previous time value. In other words, it has the value of the final time minus the value of the initial time. In case this operation is being performed in a digital channel, the variation of its countings will be computed.
Accumulation ²	1	Receives the accumulated value of the selected channel. At a configurable time rate (in seconds), gets the current channel value and sums to the accumulated amount.
ByteInv FloatToFloat ³	2	Transforms two 16-bit values in a "float". It works just like the FloatToFloat operation, but each register has its bytes swapped (byte high ↔ byte low) right before the operation. Useful when the register read from a slave has a byte order (<i>endianness</i>) which is opposite to the one expected by Data Logger .
ByteInv Int32ToFloat ³	2	Transforms an integer 32-bit signaled value in a floating point value. It works just like the Int32ToFloat operation, but each register has its bytes swapped (byte high ↔ byte low) right before the operation. Useful when the register read from a slave has a byte order (<i>endianness</i>) which is opposite to the one expected by Data Logger .

(1) **Note 1:** Available from firmware version 1.10 on.

(2) **Note 2:** Available from firmware version 1.20 on.

(3) **Note 3:** Available from firmware version 1.40 on.

When an error occurs on any channel (for example, disconnected sensor in an analog channel), its configured error value is set to it. If this channel is used as an operand of a virtual channel, its error value will be detected and the outcome of the virtual channel will be its own configured error value, leading to a propagation of the error values. The only exception is the operation "Int32ToFloat", that does not propagate the error of the source channels (operands), because it is typically used in the conversion of two remote channels in a 32-bit value and, in this case, it would show an error every time one of the remote channels would have the error value (all values are valid – there is no error value that can be set outside of the valid range).

Sample of chaining virtual channels in order to obtain more complex formulas

As an example, we will be using the formula for calculating the flow measurement using an orifice plate, which is very popular in the industrial instrumentation environment. The formula is the following:

$$Q = K \sqrt{\frac{\Delta P}{\rho}}$$

Where Q = flow

ρ = flow density

ΔP = differential pressure

K = constant that makes the appropriateness of units and dimensions involved

In this case, we will be considering that the differential pressure (ΔP) will be read as an analog channel (ChAnalog_1 = ΔP), with the limits configured for measuring the correct unit.

In the Configurator software, we must enter the following virtual channels:

VC1 = K ("constant" operation with the numeric value of K)

VC2 = ρ ("constant" operation with the numeric value of ρ)

VC3 = ChAnalog_1 / VC2 ("Division" operation)

VC4 = $\sqrt{\text{VC3}}$ ("square root" operation)

VC5 = VC1 x VC4 ("multiplication" operation)

As a result, VC5 has the flow value of Q.

USB INTERFACE

The **Data Logger** has two USB interfaces: one USB device, used for the configuration, monitoring and data downloading, and one USB host, used for data download and firmware updates, if and when necessary.

USB DEVICE

The USB interface device is the preferential interface for the equipment configuration. It is the only interface that can never be disabled.

To access it, use the USB cable supplied. The "USB" LED turns ON, indicating that the interface is ready for use. On first access, it may be necessary to install the USB drivers on your computer. If you have to do this, refer to the "USB Driver Installation" section.

The communication on this interface is Modbus RTU, just like as the slave interface RS485. The same commands and the same table of registers are available for this interface (refer to the document "**Data Logger** – Modbus").

USB HOST

The USB host interface can be used to download the recorded data from either the internal flash memory or the SD Card (it will download the memory currently configured), via a USB flash drive.

In order to perform the data download with a USB flash drive, this option must have been enabled on the Configurator software. If enabled, when you connect the USB flash drive in the USB host interface, the "USB" LED should turn ON indicating that it has been correctly recognized. From then on, the transfer of data to the USB flash drive is started and the "USB" LED starts to flash quickly. When all data has been transferred, the "USB" LED stops flashing and stays on, indicating that the USB flash drive can now be removed.

If data download with a USB flash drive has been disabled, nothing will happen when you plug in a USB flash drive in the USB interface, the LED will not turn on.

There is an option to download all the memory or to download data of a limited number of days. In the second case, you can still choose if to download the earlier or later data.

Example: When configuring the download of the most recent four-day data, the logger scans the memory and transfers to the USB flash drive all logging data found from the last four days that actually has some logged data.

Remarks:

- Use a USB flash drive with enough free capacity for all data that must be downloaded (preferably an empty USB flash drive).
- Depending on the volume of data and the busy rate of the **Data Logger** processor, the download may require a long period of time. To optimize data download via USB flash drive, try to download data more frequently and set the Download Period option for a few days, which will reduce the data volume in each download.

Throughout the **Data Logger** operation, while not downloading data to the USB flash drive, different types of errors generate 3 blinks on the status LED. When the USB flash drive is connected for download and an error occurs, it is indicated as shown in the table below:

NUMBER OF BLINKS	ERROR
1	Not enough space on the USB flash drive
2	File not found
3	USB flash drive disconnected before the end of the download
4	Writing error in USB flash drive
5	Error in creating the path in the USB flash drive
6	Error opening the download session: there is already an open session (configuration or download)

ETHERNET INTERFACE



Function not available in models "**Data Logger – USB, 512k logs, RS485**" and "**Data Logger – USB, 512k logs, RS485, 24 V**".

The **Data Logger** Ethernet interface allows connection to Ethernet 10/100 Mbps networks. There are several services available for this interface, all enabled and configured individually, which gives the **Data Logger** a high degree of versatility.

NOTE: It is always recommended to disable an interface or a service, when it is no longer needed.

For connection to the TCP-IP network, you can set a fixed IP or use DHCP (*dynamic host configuration protocol*, the protocol that allows an IP number assigned by the network server). Furthermore, if desired, you can enable the DNS service, where in some services, instead of the IP number of the servers, you can configure your name (URL).

The following services are available:

MODBUS-TCP

The **Data Logger** can be enabled to communicate through Modbus-TCP protocol, widely used in SCADA systems. By enabling this functionality, the **Data Logger** will act as a Modbus-TCP server, allowing channel values, as well as status and configuration information, to be read and written by external software applications. Enabling the gateway functionality (assuming the device is configured as a Modbus-RTU/RS485 master), the Data Logger can forward Modbus requests to slaves connected to the Modbus-RTU network.

The **Data Logger** must be accessed by the ID "255". Any other ID will be assumed to be targeting a Modbus-RTU/RS485 slave through **Data Logger** by the gateway function. In this case, if this functionality is enabled, the data packet will be forwarded to the RS485 bus.

The gateway functionality works as a multiplexer, receiving all the simultaneous Modbus-TCP connections and putting them in a line to be sent to the Modbus-RTU network, one at a time. Due to this line, in a worst-case scenario, Modbus-TCP clients' timeout should be set as long or longer than Modbus-RTU master timeout (configured in the Remote

shorter than that value, a timeout must occur instead of an exception code “0Bh” (Gateway Target Device Failed to Respond) in a missing slave situation.

SENDING E-MAILS - SMTP

The **Data Logger** can be configured to send e-mails to multiple receivers upon the occurrence of alarms or events. The receivers must be entered in the data logger through the logger configuration. In the alarm configuration, you must select which receivers should be notified via e-mail on the occurrence of each alarm or event.

For this service, you must configure an e-mail server that will be accessed at the time as the alarm occurrence. On this server, there must be a valid e-mail account for the **Data Logger** to login.

NOTE: SSL connections are not supported.

In the e-mail message body there are two parts: a constant part that is common to all messages, and a variable part that is dependent on the alarm or event that originated the message. The constant part is defined by the user, as well as the message subject. The variable part contains the **Data Logger** tag, its serial number and a string describing the alarm condition or event that caused the message.

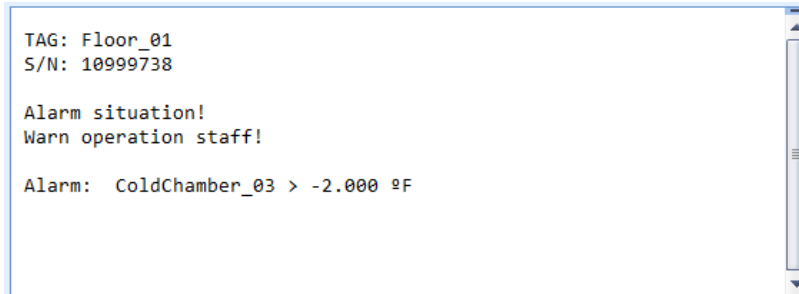

Fig. 22 - Example of alarm message

IMPORTANT: E-mails do not have delivery or reading guarantees. Thus, in alarm cases, it is desirable to use other ways to report alarm or events.

WEB PAGES - HTTP

Data Logger has the capacity to serve web pages. It has three unchangeable and always available pages with basic information about channels, configuration, status and alarms. Besides that, from firmware version 1.30 on, is is capable of serving custom web pages, which are hosted in the SD card.

UNCHANGABLE PAGES

Data Logger has the capacity to serve three unchangeable web pages: one that has basic information about the enabled channels, one that has configuration information and equipment status and one with configured alarms information. There are two possible formats for these pages: HTML or XML. These pages include simple HTML code and can be viewed with most popular browsers. They are reloaded automatically at a configurable rate. Pages in XML format have the same information as that found in the related HTML pages, in a standardized format (format descriptions are available in the product CD), which allows the external usage of this data, increasing application flexibility (a typical application is the generation of a customized HTML page with data read from the XML page). There is no automatic reload of XML pages.

In order to ease information access, it is possible to use links to get directly into the desired webpage and to the most interesting information, as the following table shows.

Web Pages	HTML	XML
Channels	DATA LOGGER_IP\channels.html	DATA LOGGER_IP\channels.xml
Configuration and Status	DATA LOGGER_IP\status.html	DATA LOGGER_IP\status.xml
Alarms	DATA LOGGER_IP\alarms.html	DATA LOGGER_IP\alarms.xml

If only the IP address of the logger is typed in the browser, the channels HTTP page will be loaded.

	Pages in XML format and the links with direct access to Data Logger pages are available only from firmware version 1.10 on.
--	--

The channel information page reports, for each enabled channel, its tag, its current value, its unit, its type (analog, digital, remote or virtual) and also if this channel is enabled for logging.

Index	Tag	Value	Unit	Type	Logged
1	Furnace_1	75.5	°F	ANALOG	Yes
2	Furnace_2	-1.0	°C	ANALOG	Yes
3	BoilerPressure	-1.000	bar	ANALOG	Yes
4	BoilerTemp	-1.0	°F	ANALOG	Yes
5	Furnace1_Door	1.0		DIGITAL	Yes
6	Furnace2_Door	1.0		DIGITAL	Yes
7	RHT_TEMP	227.0		REMOTE	No
8	RHT_RH	563.0		REMOTE	No
9	const	10		VIRTUAL	No
10	TEMP_RHT	22.7	°C	VIRTUAL	No
11	RH_RHT	56.3	%	VIRTUAL	No
12	T_RHT	2.2	°C	VIRTUAL	No
13	R_RHT	5.6	%	VIRTUAL	No
14	DiffTemp	-1.0	°F	VIRTUAL	No

Fig. 23 - Channels information HTML page

The configuration and status information page has the current status of parameters, as well as serial number, firmware version and other information from the equipment.

Information	Value
Tag	FieldLogger
Serial Number	11131033
Firmware Version	0.05
Date	21/09/2011
Time	14:53:28
Analog Scan Interval	500.0 ms
Logging Interval	250.0ms
Modbus Mode	Master
Logging Memory	SD Card
Start Logging Mode	Immediately
Stop Logging Mode	Full Memory
Logging Status	Stopped
Flash Memory	2162688 bytes
Flash Memory Free Space	2162688 bytes
SD Card	Yes
SD Card Free Space	3983966208 bytes
Pen Drive Inserted	No
HMI Inserted	No

Fig. 24 - Configuration and status information HTML page

The Alarms information page shows, for each enabled alarm, its index, the related channel, the condition, the set point, hysteresis, the unit (if configured) and if the alarm is activated (ON) or not (OFF).

Alarm	Channel	Condition	Set Point	Hysteresis	Unit	State
Alarm: 01	Furnace_1	>	250.000	0.000	°F	Off
Alarm: 02	Furnace_2	>	250.000	0.000	°C	Off
Alarm: 03	BoilerPressure	>	3.500	0.000	bar	Off
Alarm: 04	Furnace1_Door	!=	0.000	0.000		On
Alarm: 05	Furnace2_Door	!=	0.000	0.000		On
Alarm: 06	DiffTemp	>	20.000	0.000	°F	Off

Fig. 25 - Alarms information HTML page

CUSTOM PAGES

The **Data Logger** can serve web pages that are hosted in its SD card, since they are located in the “webserv” folder. These pages can use much information directly from the **Data Logger**, like channels values and units, clock time and serial number.

Working conditions

- All needed files must be placed inside the “webserv” folder in the SD card.
- **Data Logger** works in the “8.3” file name format, so no file should have more than 8 characters (plus the 3 of the extension).
- Files with markers that should be replaced by the **Data Logger** information need their names to start with the “_” character. Otherwise, these markers will not be replaced. Files which are not started with this “_” will not be parsed and will be served faster.
- Subfolders are accepted, though the maximum path length must be limited to 60 characters top (including the “webserv” folder and the “/” characters).
- If a valid marker is used with a channel or alarm that does not exist (example: analog channel 130), an “ERROR” message is returned.
- If a valid marker is used with a channel or alarm that is disabled, a “DISABLED” message is returned.
- Whenever you want to display the character “%”, it is advisable to use it doubled “%%”. It will assure that it will not be misinterpreted with a marker start.

MARKERS

A lot of information from **Data Logger** is available to be inserted in the custom web pages. It is done by the use of alphanumeric markers that, when found in the file, are replaced by their related value. Again, this will only happen in the files whose names start with a “_” (example: “_data.htm”).

These are all available markers:

Marker	Replacement information
%ANALOG__001.T%	Analog channel 1 tag
%ANALOG__001.V%	Analog channel 1 current value
%ANALOG__001.U%	Analog channel 1 unit
%ANALOG__001.D%	Analog channel 1 diagnostics information value: Bit 0: open sensor Bit 1: shorted Pt100/Pt1000 Bit 2: out of limits Bit 3: Pt100/Pt1000 open cable
...	...
%ANALOG__008.T%	Analog channel 8 tag
%ANALOG__008.V%	Analog channel 8 current value

%ANALOG__008.D%	Analog channel 8 diagnostics information value: Bit 0: open sensor Bit 1: shorted Pt100/Pt1000 Bit 2: out of limits Bit 3: Pt100/Pt1000 open cable
%DIGITAL__001.T%	Digital channel 1 tag
%DIGITAL__001.V%	Digital channel 1 current value
%DIGITAL__001.U%	Digital channel 1 unit
...	...
%DIGITAL__008.T%	Digital channel 8 tag
%DIGITAL__008.V%	Digital channel 8 current value
%DIGITAL__008.U%	Digital channel 8 unit
%REMOTE__001.T%	Remote channel 1 tag
%REMOTE__001.V%	Remote channel 1 current value
%REMOTE__001.U%	Remote channel 1 unit
...	...
%REMOTE__064.T%	Remote channel 64 tag
%REMOTE__064.V%	Remote channel 64 current value
%REMOTE__064.U%	Remote channel 64 unit
%VIRTUAL__001.T%	Virtual channel 1 tag
%VIRTUAL__001.V%	Virtual channel 1 current value
%VIRTUAL__001.U%	Virtual channel 1 unit
...	...
%VIRTUAL__128.T%	Virtual channel 128 tag
%VIRTUAL__128.V%	Virtual channel 128 current value
%VIRTUAL__128.U%	Virtual channel 128 unit
%ALARM__001.STS%	Alarm 1 tag
%ALARM__001.SPT%	Alarm 1 status: "ON" (active alarm) or "OFF" (not active)
%ALARM__001.CND%	Alarm 1 configured setpoint
%ALARM__001.UNI%	Alarm 1 configured condition: ">", ">=", "<", "<=", "==" or "!="
%ALARM__001.HYS%	Alarm 1 configured unit
...	...
%ALARM__032.TAG%	Alarm 32 tag
%ALARM__032.STS%	Alarm 32 status: "ON" (active alarm) or "OFF" (not active)
%ALARM__032.SPT%	Alarm 32 configured setpoint
%ALARM__032.CND%	Alarm 32 configured condition: ">", ">=", "<", "<=", "==" or "!="
%ALARM__032.UNI%	Alarm 32 configured unit
%ALARM__032.HYS%	Alarm 32 configured hysteresis
%INFO.IN.FLTAG_%	Data Logger tag
%INFO.IN.SERIAL%	Serial Number
%INFO.IN.FWVER_%	Firmware version
%INFO.IN.MBMODE%	Main RS485 interface Modbus mode: "Disabled", "Master" ou "Slave"
%INFO.IN.MBADDR%	Main RS485 interface Modbus address
%INFO.IN.D_TYPE%	Selected logging memory: "Flash" or "SD Card"
%INFO.IN.START_%	Start logging mode selected: "Immediately", "Date/Time", "Alarm" ou "Via Modbus Only"
%INFO.IN.STOP_%	Stop logging mode selected: "Full Memory", "Circular Memory", "Date/Time" ou "Alarm"
%INFO.IN.FDRVIN%	USB flash drive connection status:

%INFO.IN.SDSIZE%	SD card memory capacity, in kbytes
%INFO.IN.SDFREE%	SD card available free memory, in kbytes
%INFO.IN.INSIZE%	Internal flash memory capacity, in bytes
%INFO.IN.INFREE%	Internal flash available free memory, in bytes
%INFO.IN.ANLSCN%	Analog channels scan interval, in ms
%INFO.IN.LOGPER%	Logging interval, in ms
%INFO.IN.LOGSTS%	Current logging status: "Logging" or "Stopped"
%INFO.IN.HMICON%	HMI connection status: "0" (no HMI) or "1" (HMI connected)
%INFO.RTC.YEAR_%	Internal calendar year
%INFO.RTC.MONTH%	Internal calendar month
%INFO.RTC.DAY__%	Internal calendar day
%INFO.RTC.HOUR_%	Internal clock hour
%INFO.RTC.MIN__%	Internal clock minute
%INFO.RTC.SEC__%	Internal clock second

FILE TRANSFER - FTP

The **Data Logger** provides both FTP client and server for the transferring of data files.

Client

FTP client is used to make programmed downloads of logging data. It can be done once a day, in a determined time, or many times a day, in a determined time interval (this option requires firmware version 1.50 or higher). In order to use, simply configure the username and password to be used in server login and set the daily download start time or the interval between them, depending if the "periodic" download (more than once a day) option is enabled. In case of downloading at periodic intervals, start download moments are always referred to midnight (example: 4-hour interval will turn out to downloads at 00:00, 04:00, 08:00, 12:00, 16:00 and 20:00). If, at the time configured for starting the download, a problem with the connection arises, the **Data Logger** will retry for 30 minutes.

From firmware version 1.40 on, you can download data directly in the CSV (comma-separated values) format. When selecting this option for the client FTP download, the files created in the download folder will be in the CSV format instead of the binary (standard) format.

The created CSV file will have the equipment tag in its first row. In the second row, there will be the column names. From the third row on, there are the dates, times and channel values for each log. If the logging rate was configured in milliseconds, this extra column will be placed before the values columns. All fields are between quotation marks (") and the field separator used is the semi-colon (;).

Due to the extra processing to transform the files to the CSV format, this option may cause a delay in the download.

Note: Due to a limited size of the **Data Logger** internal buffer, it is recommended that FTP server welcome message should have sentences no longer than 60 characters (each sentence must necessarily be finished with "car return" and "new line" characters, or "0Dh" and "0Ah" in hexadecimal).

Server

To use FTP server on the **Data Logger**, simply enable this feature in the Configurator application and set up a username and password. In this way, the user will have access to the data files for read-only purposes. The standard used for the FTP is the "Unix" type.

Note: There is no support for simultaneous connections. Therefore, the used client will have to be configured to just use one connection. In addition, the client must be configured to use the passive mode.

NETWORK MANAGEMENT - SNMP

All of the enabled channels for reading, as well as several status information, have their values available via SNMP protocol (read-only, there is no writing implemented on the equipment via SNMP).

	<p>Standard MIBs are not available in Data Logger. Available SNMP information is listed below, besides the following OIDs of the "System" group:</p> <ul style="list-style-type: none"> • sysDescr • sysObjectID • sysUpTime
---	--

The available MIB is described below. A MIB file is available in the product CD. The branch "Enterprise" of MIB is used, where the "Enterprise number" is **34590**. The sub-branch assigned to **Data Logger** is **1**. Thus, all information will have the OID starting in **1.3.6.1.4.1.34590.1**.

The available OIDs:

- 1.3.6.1 .4.1.34590.1.0 = Device tag. [OCTET STRING]
- 1.3.6.1 .4.1.34590.1.1 = Device serial number. [OCTET STRING]

- 1.3.6.1.4.1.34590.1.3 = Device date year. [INTEGER]
- 1.3.6.1.4.1.34590.1.4 = Device date month. [INTEGER]
- 1.3.6.1.4.1.34590.1.5 = Device date day. [INTEGER]
- 1.3.6.1.4.1.34590.1.6 = Device time hour. [INTEGER]
- 1.3.6.1.4.1.34590.1.7 = Device time minute. [INTEGER]
- 1.3.6.1.4.1.34590.1.8 = Device time second. [INTEGER]
- 1.3.6.1.4.1.34590.1.9 = RS485 interface enabling and configuration (0 = disabled; 1 = master; 2 = slave). [INTEGER]
- 1.3.6.1.4.1.34590.1.10 = Selected logging memory (0 = internal memory; 1 = SD card). [INTEGER]
- 1.3.6.1.4.1.34590.1.11 = Logging status (0 = logging stopped; 1 = logging in progress). [INTEGER]
- 1.3.6.1.4.1.34590.1.12 = Available memory for logging in internal memory, in bytes. [INTEGER]
- 1.3.6.1.4.1.34590.1.13 = Presence of SD card (0 = no card; 1 = card present). [INTEGER]
- 1.3.6.1.4.1.34590.1.14 = Available memory for logging in the SD card, in kilobytes. [INTEGER]
- 1.3.6.1.4.1.34590.1.15 = Presence of USB flash drive (0 = no USB flash drive; 1 = USB flash drive present). [INTEGER]
- 1.3.6.1.4.1.34590.1.16 = Presence of the DISPLAY (0 = no DISPLAY; 1 = DISPLAY present). [INTEGER]
- 1.3.6.1.4.1.34590.1.17 = Total number of enabled channels. [INTEGER]
- 1.3.6.1.4.1.34590.1.18.X.Y
 - X = Sequential channel number, starting with analog channels and followed by the digital, remote and virtual ones:
 - X = 1: First channel enabled.
 - X = 2: Second channel enabled.
 - etc.
 - Y = Channel information:
 - Y = 1: Channel tag. [OCTET STRING]
 - Y = 2: Channel read value. Wherever appropriate (virtual and analog channels, for example), it will be multiplied by the number of decimal places configured by the user. [INTEGER]
 - Y = 3: Channel unit. [OCTET STRING]
 - Y = 4: Channel type indication (analog, digital, etc.), and the channel number related to this type. Examples: ANALOG_001, DIGITAL_005, REMOTE_014, VIRTUAL_103. [OCTET STRING]
 - Y = 5: Channel error indication (0 = channel ok; 1 = channel in error state). [INTEGER]
 - Y = 6: Indicates that the channel is enabled (value = 1) or disabled (value = 0) for logging. [INTEGER]

Traps

Traps will be generated if enabled and selected in the alarms in order to indicate their occurrence. The address and destination port are configurable.

They have the following fields:

- Community: "**Data Logger**".
- OID: .1.3.6.1.4.1.34590.1.100 (where **34590** is the "enterprise number" used and the **1** following is the branch of **Data Logger**)
- General number: 6 (indicating that the trap is "enterprise-specific").
- Specific number: Index for the occurred alarm (zero - based).
- Trap value
 - OID: .1.3.6.1.4.1.34590.1.100.XX, where XX is the index of the occurred alarm.
 - Type: OCTET STRING.
 - Value: String indicating the occurred alarm in the format: TAG + CONDITION + VALUE. Example: "Channel_1 > 129.43"

DATA LOGGING AND DOWNLOAD

Data logging can be done in the internal memory of the **Data Logger** or, optionally in a SD card (not included), which must be inserted into the proper compartment behind the cover (or DISPLAY). The internal memory capacity is up to 532,480 measurements, SD card logging capability will depend on its storage capacity (size), assuming that the card is empty.

NOTE: Poor quality SD cards can compromise data logging, causing missed recording periods at higher storage rates or become more susceptible to data write corruption. Therefore, it is always recommended you use high-speed (class 4 or higher) SD cards from established brands.

	SD Card logging not available in models “FieldLogger – USB, 512k logs, RS485” and “FieldLogger – USB, 512k logs, RS485, 24 V”.
---	--

Any channel (analog, digital, remote and virtual ones) can be written into the memory. Logging is periodic and has its storage (rate) set through the Configurator software. After each time interval, the current values of the configured channel are logged in the selected memory.

There are several ways to start and stop the recording, and many of them can be freely combined. During the recording, all the selected channels will be recorded in the requested memory (internal flash or SD card) based on the interval configured.

Depending on the start and stop modes selected, there may be "snippets" of data in memory, and therefore, periods without any data recorded. This is fully compatible with the data logger and is not a problem.

The start modes available are:

- **Immediate start:** Recording will start right after the data logger reconfiguration.
- **By date/time:** Recording will be started at the selected date/time.
- **By alarm:** When the alarm condition is met (alarm active), recording will be started.
- **Only by Modbus commands:** Recording will start only when a specific command is sent to the Modbus equipment.

The stop modes available are the following:

- **Full memory:** The recording will be stopped only when the selected memory (internal flash or SD card) is full.
- **Never stop (wrap around):** Recording will be continually stored in the selected memory. When the memory is full, the oldest data will be erased so that the most recent data may be saved.
- **By date/time:** Recording will start at the selected date/time.
- **By alarm:** If the recording started by the same alarm, when the alarm condition is no longer met (alarm inactive), the recording stops. If the recording was started for some other reason, as soon as the alarm condition takes place (alarm active), the recording will stop.
- **By Modbus command:** A specific Modbus command can be sent to stop the recording. This command is independent of the selected stop mode and has priority over it.

The following possibilities to start and stop recording are available:

		Logging start			
		Immediate	Date/Time	Alarm	Only Modbus command
Recording stop	Full memory	Yes	Yes	Yes	Yes
	Wrap around	Yes	Yes	No	Yes
	Date/Time	Yes	Yes	No	No
	Alarm	Yes	Yes	Yes	No

Here are the operation details for each of these modes:

- **Immediate start and stop when memory gets full:**
As soon as the new configuration is applied, recording is started. The **Data Logger** continues recording until the memory (internal or SD card) is full. In the case of a power failure, recording will be interrupted and begins again as soon as power is restored.
- **Immediate start and never stops (wrap around):**
As soon as the new configuration is applied, recording is started. The **Data Logger** goes on recording forever, overwriting the oldest data as soon as the memory is full. In the case of a power failure, recording is interrupted, and begins again as soon as power is restored.
- **Immediate start and stop by date/time:**
As soon as the new configuration is applied, recording is started. The **Data Logger** continues recording until the set date and time. In the case of a power failure, recording is interrupted and begins again as soon as power is restored. If the memory is full before the set date/time, the **Data Logger** will stop recording.
- **Immediate start and stop by alarm:**

alarm condition takes place (configured alarm for recording stop). When the alarm condition stops, recording continues. In the case of a power failure, recording is interrupted, and begins again as soon as power is restored. When the memory is full, the **Data Logger** will stop recording.

- **Start by date/time and stop when memory is full:**

Once the date/time set for recording start has occurred, recording will start. The **Data Logger** goes on recording until the memory (internal or SD card) is full. In the case of a power failure, recording is interrupted, and begins again as soon as power is restored. When memory is full, the **Data Logger** will stop recording.

- **Start by date/time and never stops (wrap around):**

Once the date/time set for recording start has arrived, the recording will start. The **Data Logger** will continue to record, overwriting oldest data as soon as the memory is full. In the case of a power failure, recording is interrupted and begins again as soon as power is restored.

- **Start and stop by date/time:**

Once the date/time set for recording start has arrived, recording will start. The **Data Logger** goes on recording until the stop date and time occurs. In the case of a power failure, recording is interrupted and begins again as soon as power is restored (if the stop date/time has not yet occurred). If the memory is full before the set stop date/time, the **Data Logger** will stop recording.

- **Start by date/time and stop by alarm:**

Once the date/time set for the recording start has occurred, recording will begin. The **Data Logger** goes on recording until the configured alarm condition takes place. When the alarm condition stops, recording continues. In the case of a power failure, recording is interrupted and begins again as soon as power is restored.

- **Start by alarm and stop when memory is full:**

When an alarm condition takes place, recording begins (it will not start if the alarm condition is already active. It will wait for the next alarm occurrence to begin recording.) The **Data Logger** continues recording until the memory is full (internal or SD card). In the case of a power failure, recording is interrupted and begins again as soon as power is restored.

- **Start and stop by alarm:**

When an alarm condition occurs, recording begins (it will not start if the alarm condition is already active. It will wait for the next alarm occurrence to begin recording). The **Data Logger** continues recording while this alarm condition is in progress. When the alarm condition stops, recording stops.

- **Start only by Modbus command and stop when memory is full:**

When the Modbus command (details about this command can be found in the document "Data Logger – Modbus" and in the chapter "Configuration and Download Software", "Diagnostics" section) to start recording is sent to the data logger, the recording will start. The **Data Logger** continues recording until the memory is full (internal or SD card).

- **Start only by Modbus command and never stops (wrap around memory):**

When the Modbus command (details about this command can be found in the document "Data Logger – Modbus" and in the chapter "Configuration and Download Software", "Diagnostics" section) to start recording is sent to the data logger, the recording will start. The **Data Logger** continues recording forever, overwriting the oldest data as soon as the memory is full.



Modbus commands to start and stop recording, when enabled, can be sent at any time and has precedence over the configured start and stop modes. In this way, if a Modbus command to start recording is sent to the data logger, recording will start, no matter the state of the data loggers' configured mode (the only exception is a configured mode different from "wrap around memory" when the memory is already full). Similarly, when sending a Modbus command to stop recording, it will stop regardless of the mode configured for start and stop. If a stop command has been sent and then there is a start command, per the configured mode, recording will not occur because the command has higher priority than the modes.

The sent command persists even after a power outage. When sending a new recording configuration, however, the previously sent commands are "over written".

When recording is on the SD card, a folder is generated for the purpose of organizing the recorded data and to simplify access for the software access to the data. The following figure shows an example of this structure:

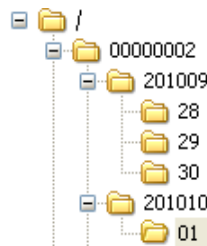

In the root folder a subfolder is created using the serial number of the data logger as its name. Inside this folder, subordinate folders are set up with the year and month in which the logging began used as the folder name. Inside of the year-months folders, other folders are generated whose names are the days in which the recording started. The data files are stored in these folders and their names are constructed by the information related to hour, minute, second and hundredths of second of the first record in the file, followed by the extension ".fl". For example, the file /00000002/201210/01/18243516.fl was generated by a **Data Logger** with the serial number 00000002 on October 01,

2012, and the first record contained in this file was recorded on this day at 18 hours, 24 minutes, 35 seconds and 16 hundredths.

The files generated by the registration process are composed of a header followed by periodic data blocks and *timestamps* (time markers). The header carries information relevant to the record from the file that is essential for the correct interpretation of its data. The data block stores values for each channel that is being recorded, in floating point format (IEEE 754) with simple precision. Each record occupies 4 bytes. The timestamps are used as time reference to identify when the channels were recorded. Periodic timestamps serve to ensure the integrity of the recording in time, even in the event of a power failure or fault in the SD card.

When recording to internal memory, the file format is exactly the same as when it is written on the SD card. However, because of the larger available memory, all data will be contained in one file.

The internal flash memory has approximately 2M bytes that will hold 512k (512000) records. The exact number depends on the enabled channels, number for recordings and on the storage interval. Storage intervals equal or longer than 30 seconds per record, requires extra data to indicate the time when the record happened (timestamp), which increases memory consumption and makes the total recording capacity decrease. Therefore, the worst possible scenario is logging only one channel on slow (longer than 30 s) intervals.

Data download consists of copying the data from the internal memory of the **Data Logger** or from the SD card to a computer. When using the configuration software supplied, the step-by-step "wizard" instructions simplify the process. When downloaded using a USB flash drive, it is also simple and automatic. When performed manually, via an FTP client, for example, you must ensure that the directory structure is kept, otherwise an error may occur in the interpretation of the data download.

It is not possible to download data through different interfaces at the same time. If you start a download through the Ethernet interface (FTP, for example) and another user tries to download via USB flash drive, this second access will not be allowed. You must wait until the first download has been terminated.

Depending on the amount of data stored, mainly when using high-capacity SD cards, the download process can take hours. In these cases, prepare to make the download through faster interfaces and, perhaps, in evening hours.

The simultaneous data download while recording is based on the assumption that the download rate is faster than the recording rate. This is particularly important when using the wrap around recording mode, because otherwise, you could not download all the data (the recording, being faster, might eventually turn around, reaching and surpassing the download, which would lead to data inconsistencies). In this case, whenever wrap around memory is used with high storage rates, you should use a faster interface for download.

ALARMS

32 alarms are available in each Data Logger. Each alarm requires you to choose a channel, a condition, a set point and hysteresis. When the alarm condition is met (example: Channel_1 > 45.0 ° C), an event is generated for which different actions can be associated. For each selected channel, its current value is used in the comparison. In the case of digital channels, use the values associated with the two logical states. When one channel is in error, the configured error value will be used in the alarm. The value of the channel to be used will always be the floating point value.

The available conditions are:

- **Greater than (>):** Alarm condition is met when the selected channel is greater than the set point.
- **Greater than or equal (>=):** Alarm condition is met when the selected channel is greater or equal to the set point.
- **Less than (<):** Alarm condition is met when the selected channel is less than the set point.
- **Less than or equal (<=):** Alarm condition is met when the selected channel is less than or equal to the set point.
- **Equal (==):** Alarm condition is met when the selected channel is equal to the set point. With this condition, hysteresis is not effective and should be maintained at "0.0". Analog channels can rarely have a value exactly equal to the set point value, so you should avoid this condition because it will be an alarm condition that might never be satisfied.
- **Different (!=):** This alarm condition is met when the selected channel differs from the set point. With this condition, hysteresis should be maintained at "0.0".
- Analog channels can rarely have a value exactly equal to the set point value, so you should avoid this condition because it will be an alarm condition that might never be satisfied.

Available actions are:

- Activating the relays (they must be configured to "activation by alarm" using the Configuration software).
- Activating the digital outputs (they be configured to "activation by alarm" using the Configuration software).
- **Recording start:** when the alarm condition is reached, recording starts if not already recording.
- **Recording stops:** when the alarm condition is reached, recording stops if not already stopped.
- **Recording start and stop:** records while the alarm condition exists.
- **Sending e-mails:** allows sending an e-mail and reporting the alarm condition to up to 10 receivers (they must have been included in the receivers list of the data logger).
- **Sending SNMP traps:** sends a trap to the configured server with a number regarding the index of the alarm.

Sending e-mails depends on the availability of TCP connections of the **Data Logger** (there is a limit of simultaneous connections, see the Specifications chapter). Sending traps depends on the availability of UDP connections in the **Data Logger** (it has a limit of simultaneous connections, see the *Specifications* chapter).

Only one alarm can start a recording, and only one alarm can stop it. When you configure the start and/or stop of the recording by alarms, there is no option of “wrap around memory”, recording will terminate as soon as memory is full.

The alarm condition must last at least 250 ms in order to ensure that it is detected. Also the output of the alarm condition must last at least 250 ms in order to guarantee that it is detected. Note that the analog channels can have a delay in the measurement of the true input value, depending on the sensor type, on intervals between readings and the configured filter, among others. The remote channels, in turn, depend directly on the set storage interval. Thus, these types of channels incur an additional latency in the detection of the alarm condition.

During power up of the **Data Logger**, there are no reliable channel values. In case of the analog and remote channels, you should wait for the first scan to be completed for valid values to be available. Alarms that use these channels may take a while before they are ready to compare with the configured set point. When using remote channels, a complete scan may take several seconds.

DATA COMMUNICATION

The **Data Logger** has several communication interfaces. Some can be used as Modbus slaves:

- RS485, acting as a slave on the Modbus RTU protocol.
- USB device, acting as a slave on the Modbus RTU protocol.
- Ethernet, acting as a server in the Modbus TCP protocol.

All **Data Logger** configurations, as well as reading the inputs, are accomplished via Modbus protocol.

You can find all the information needed to read data from the input channels without using the Configuration software in the document "**Data Logger** - Modbus.pdf" on the product CD. To ensure proper configuration and data download of, always use the Configuration software. After configuring the equipment, data on the inputs and/or outputs can be accessed by any other software capable of Modbus RTU or Modbus TCP communication.

DISPLAY (HUMAN-MACHINE INTERFACE)

The **DISPLAY** (Human-Machine Interface) is available as an accessory to the Model DL-1080 and is standard on the Model DL-1081. Several features are available with this display, such as enabled channel monitoring, viewing channels in chart mode, alarms monitoring, status checking and configuration of some basic **Data Logger** operation parameters.

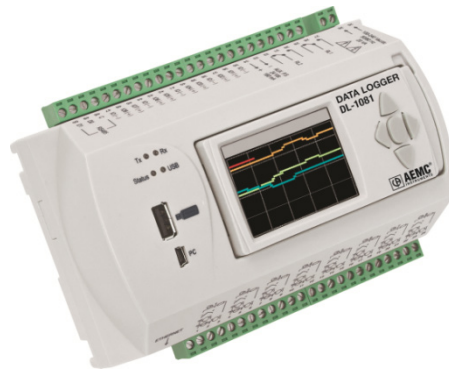

The **DISPLAY** is attached to the **Data Logger** through a DB9 connector located under the cover of the Model DL-1080. Check the *Attaching and Detaching the DISPLAY* section to see how the **DISPLAY** is connected to the **Data Logger**.

Both power and serial communication go through the DB9 connector. It is also possible to use the **DISPLAY** remotely, attaching it to the **Data Logger** through a serial extension cable. The communication between **DISPLAY** and the **Data Logger** is accomplished using RS485 at a baud rate of 115200 bps. This limits the **DISPLAY** operating distance. The voltage drop allowed in the power cables (both positive and negative leads summed) must be no more than 0.4V. Considering a current consumption of 80mA, the maximum cable resistance can be 5Ω. For some common cables, the **DISPLAY**'s maximum operation distance is shown in **Table 02**.

Gauge	Section	Maximum Length
24 AWG	0.21mm ²	29m
22 AWG	0.33mm ²	47m
20 AWG	0.52mm ²	75m

Table 02 – Wire resistance

Figure 27 below shows the pin-out needed to build an extension cable to the **DISPLAY**.

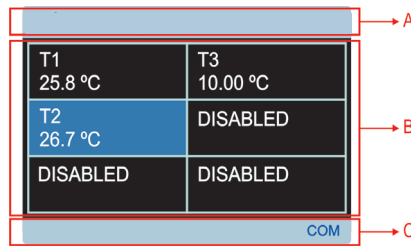

Figure 27 – Building an extension cable

PIN	SIGNAL	DESCRIPTION
1	-	-
2	+5 V	DISPLAY power input: +5 VDC
3	-	-
4	B / D1 / D+ / D	RS485 Tx/Rx positive data
5	-	-
6	-	-
7	GND	DISPLAY power input: ground
8	A / D0 / D- / D\	RS485 Tx/Rx negative data
9	-	-

Table 03 – Pin-out for building the DB9 connectors

The **DISPLAY** screen is divided into three sections: top bar, main area and bottom bar.
 The top bar (A) shows the **Data Logger** logo and the name of the current screen.
 The main area (B) shows the information associated with that screen.
 The bottom bar (C) shows alarms, download progress and serial communication indication whenever necessary.



The bottom bar has the following information:

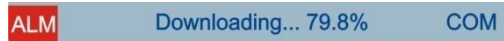
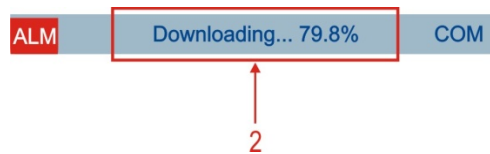

Figure 29 – DISPLAY bottom bar

- **Alarm events (1):** Shows that one or more alarms are active. In order to check which alarms are active, go to the Alarms screen.



- **Download progress (2):** When plugging a USB flash drive to download the data, there is a percentage indication of the download completed. If downloading data from internal flash memory, it shows the percentage of the total memory already downloaded. If downloading from the SD card, it shows the percentage of the current file being downloaded.



- **Communication in progress (3):** Informs that there is communication between the DISPLAY and the **Data Logger**. Typically, this flag will be on most of the time, varying from screen to screen. If this flag stays off and the DISPLAY stops updating, there most likely is a communication problem between the DISPLAY and the **Data Logger**.

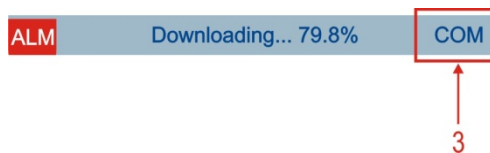

Interfacing with this DISPLAY is accomplished using the navigation buttons, which allow you to move between all the available screens and select and edit parameters. The following figure shows the keys and their functions.

Not all characters can be viewed on the DISPLAY. Limited characters for tags and units are recommended.

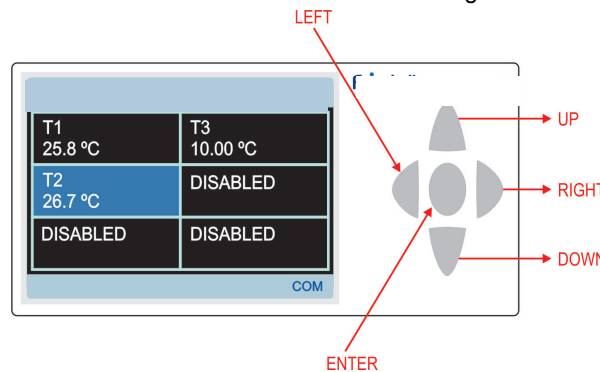

Navigation between the screens is accomplished through keys RIGHT and LEFT. There are six different screens, each one with specific functionality, as follows:

“FAVORITES” SCREEN

This screen shows a six-position grid where you can assign a channel to be displayed in each position. Every enabled channel in the *Data Logger* is available for assignment, this is accomplished using UP and DOWN keys to select the desired position in the grid and ENTER to open a list of the available channels. Next, use the UP and DOWN keys again to find the channel you want to display and ENTER to select it.

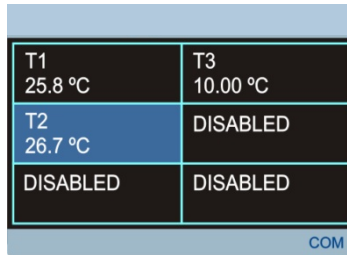

“CHART” SCREEN

This screen saves a log of the favorite channels values. The time period of this log, the limits of the channels displayed (vertical limits of the chart) and other parameters can be configured in the “Parameters” screen. Pressing the ENTER key will bring up a legend screen with the tags of your favorite channels that is on the chart along with their associated colors. Pressing the ENTER key again will show the parameters configured for the chart. Pressing the ENTER key one more time will return to the Chart screen. The red color is reserved to indicate that one or more channels have values over the high limit or under the low limit configured for the chart.

The log starts at the moment the *DISPLAY* is powered and it is updated constantly, no matter which *DISPLAY* screen is viewed. It is important to note that this log is limited to the data that can be seen in the screen (100 points) and it is not possible to retrieve old (out-of-the-screen) data. It is also important to note that this log is independent the recording in the *Data Logger*.

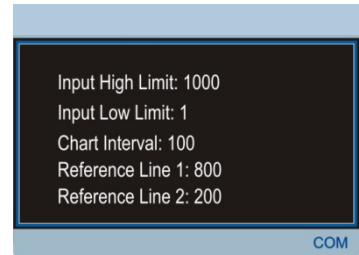
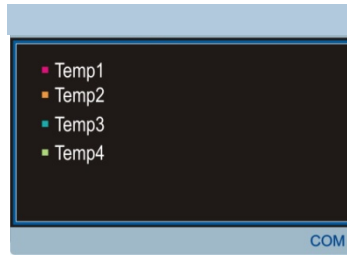
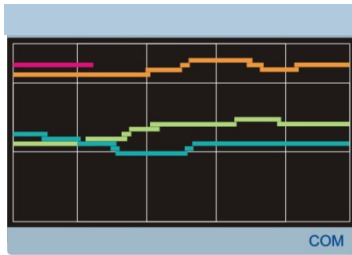

“CHANNEL LIST” SCREEN

This screen shows a list of all enabled channels (analog, digital, remote and virtual). The UP and DOWN keys are used to navigate between the channels. The ENTER key has no function on this screen.

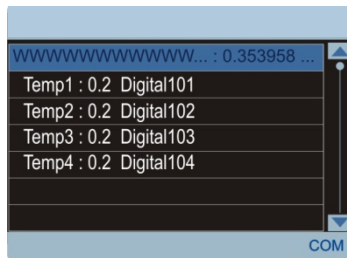

“ALARMS” SCREEN

The Alarms screen has a 32-position grid where each numbered position is related to its equivalent alarm or event. When an alarm is active, its number will be displayed in red on this screen.

An alarm flag will appear on the bottom left side as long as any of the enabled alarms are active. This flag will show in all screens. The UP, DOWN and ENTER keys have no function on this screen.

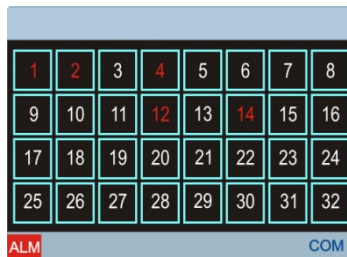

“STATUS” SCREEN

A list is shown in the status screen with information about the **Data Logger** and the DISPLAY itself. Navigation is accomplished using the UP and DOWN keys. The ENTER key has no function.

Information is organized in a hierarchical way, where hierarchical levels are displayed by indentation on the left side. Parameters that indented belong to the previous left justified parameter.

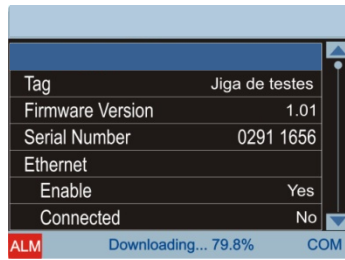

The following parameters can be monitored on this screen:

- Data Logger:** **Data Logger** information
 - Tag..... Configured tag for the **Data Logger**
 - Firmware Version **Data Logger** firmware version
 - Serial Number **Data Logger** serial number
 - Ethernet Ethernet interface information
 - Enabled..... Yes/No if interface enabled/disabled
 - Connected..... Yes/No if interface cable connected/disconnected
 - Data Logger: Information about data recording
 - Scan Interval Analog scan interval configured
 - Logging Rate..... Storage rate configured
 - Logging Enable Yes/No if logging is enabled/disabled
 - Storage Memory Shows where data is being stored
 - SD Card Connected..... Yes/No if SD card connected/disconnected
 - Recording Status Indicates if recording is active or stopped
 - Recording Mode..... Recording mode information
 - Start..... Indicates how recording will start
 - Stop..... Indicates how recording will stop
 - SD Free Memory..... Shows the available memory for recording on the SD card
 - Int. Free Memory..... Shows the available memory for recording using internal memory
- DISPLAY**..... **DISPLAY** information
 - Firmware Version **DISPLAY** firmware version
 - Serial Number **DISPLAY** serial number

“CONFIGURATION” SCREEN

Some *Data Logger* and DISPLAY parameters can be changed on this screen. In order to edit a parameter, you should first select it by pressing the UP and DOWN keys. Once it is selected, press the ENTER key to enter the edit mode. When in edit mode, the UP and DOWN keys can be used to edit the parameter value (increment and decrement). When editing a parameter composed by more than one field (like IP addresses) select the correct field using the RIGHT and LEFT keys. Single field parameters that have a wide range have a special way to change the increment/decrement factor using the RIGHT and LEFT keys during editing: it starts with a factor of “1”; every time you press the LEFT key, it multiplies this factor by 10 (tens, hundreds, thousands, ...); every time you press the RIGHT key, it divides this factor by 10 (thousands, hundreds, tens, ...). Once you have the desired value, press ENTER to complete the edit mode.

As with the “Status” screen, information here is organized in a hierarchical way:

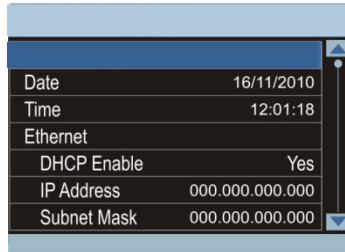

The available parameters on screen are:

- Data Logger** **Data Logger** configuration
 - Date Date configuration
 - Time Time configuration
 - Ethernet Ethernet interface configuration
 - DHCP Enable..... DHCP enabling
 - IP Address IP address configuration
 - Subnet Mask Subnet mask configuration
 - Gateway Gateway address configuration
 - Modbus RTU Modbus RTU interface configuration
 - Mode Operation mode: master/slave
 - Slave Address Modbus slave address
 - Baud rate Communication baud rate
 - Parity Communication parity
- DISPLAY** **DISPLAY** configuration
 - Backlight Timeout..... Backlight turn off time (0 = always on)
 - Chart “Chart” screen configuration
 - Color Background Background color: black/white
 - Interval Period of time displayed on the Chart
 - Reference Value 1 First reference line value*
 - Reference Value 2 Second reference line value*
 - Input High Limit Chart maximum displayed value**
 - Input Low Limit..... Chart minimum displayed value**

* For disabling the reference lines, configure them to a value outside of the input configured range.

** If the Low Limit is configured to a value greater than the High Limit, the Chart will not display the values of the channels in a correct way!

EQUIPMENT SOFTWARE/FIRMWARE UPDATE

The **Data Logger** allows firmware updating in the field, through a USB flash drive. The current firmware version is available on www.aemc.com. The procedure for updating firmware is as follows.



Before performing the update, download any data in the data loggers' memory and, if desired, also the data logger's configuration. Saving it to a file. Both the configuration and the logged data in flash memory will be lost in the upgrade process.

1. Turn off and unplug all **Data Logger** connections attached to it.
2. Copy the *flogger.flb* file, which is the binary firmware file of the **Data Logger** into USB flash drive root folder.
3. Insert the USB flash drive into the USB host of the **Data Logger** (that must remain off).
4. Plug in the power cord, apply power then turn the **Data Logger** ON again. The status and USB LEDs should flash together, indicating that the boot loader is running.
5. The status LED should still be flashing in the same pattern. The USB LED should flash quickly while the *flogger.flb* file copy is being performed. Once the copy has been completed, the USB LED should stay lit, indicating that the USB flash drive can be removed.
6. If there is an error while copying (writing) the firmware to the **Data Logger**, it will be indicated by the status LED. It will stop flashing periodically and begin repeatedly showing a pattern of blinking associated with the error that occurred.

Blinks	Description
1	An error occurred in reading <i>flogger.flb</i> file.
2	Error in initializing the Data Logger USB host (when inserting the USB flash drive)
3	Error in erasing the Data Logger program memory.
4	Error in writing to the Data Logger program memory.
5	The written firmware is larger than the program memory available in the Data Logger . The writing only partially occurred.
6	Error in closing <i>flogger.flb</i> file.
7	Invalid <i>flogger.flb</i> file.

7. Remove the USB flash drive from the USB host portion on the **Data Logger**.
The **Data Logger** should reset itself automatically and may be returned to normal use with the updated firmware. It is recommended that you delete the firmware file (*flogger.flb*) from the USB flash drive to prevent undesired updates in the future.

CLOCK BATTERY REPLACEMENT

The **Data Logger** clock is kept by an internal battery as long as the equipment is not supplied by the AC power. In case of battery discharge, logged dates and times may not be correct. Whenever the **Data Logger** detects such a situation, it informs you by continuously flashing the Status LED three times in a row (check the *Flags (LEDs)* section).



Replace battery with Panasonic lithium battery Part No. CR 2032 only.

Usage of another battery may present a risk of fire or explosion.

Replacement procedure is described as follows:

- Detach **Data Logger** from DIN rail.

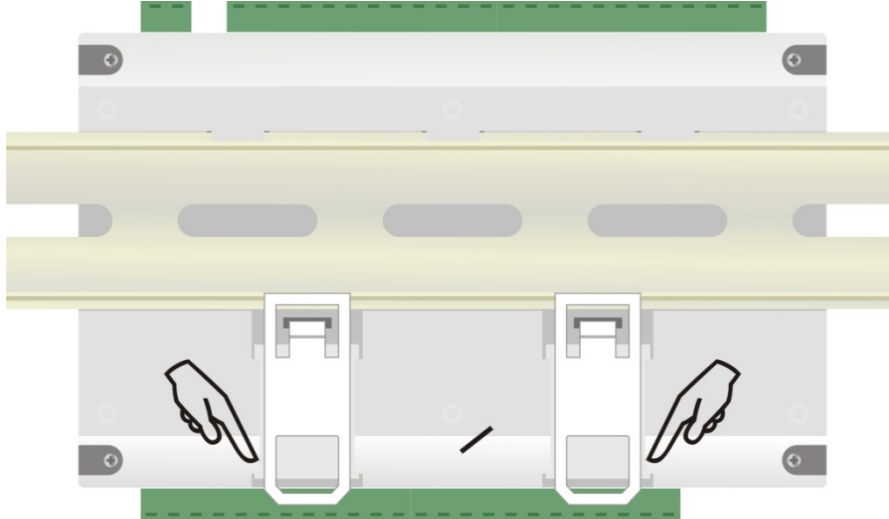

- Disconnect all terminals carefully.
- Unscrew the four screws located under the enclosure. Remove the back cover being careful not to remove the circuit board.

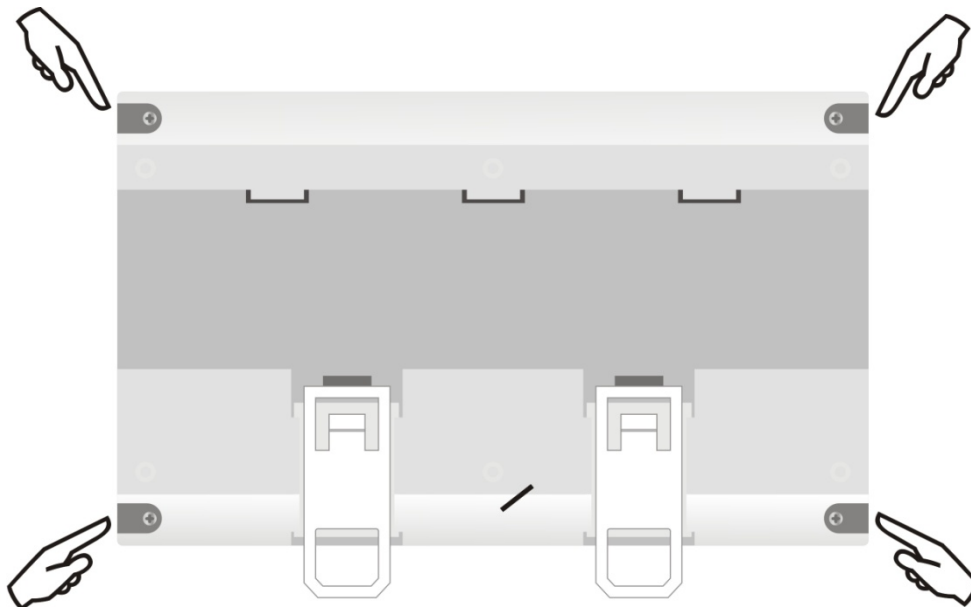

- After removing the back cover, remove the battery. Avoid touching the circuit board!

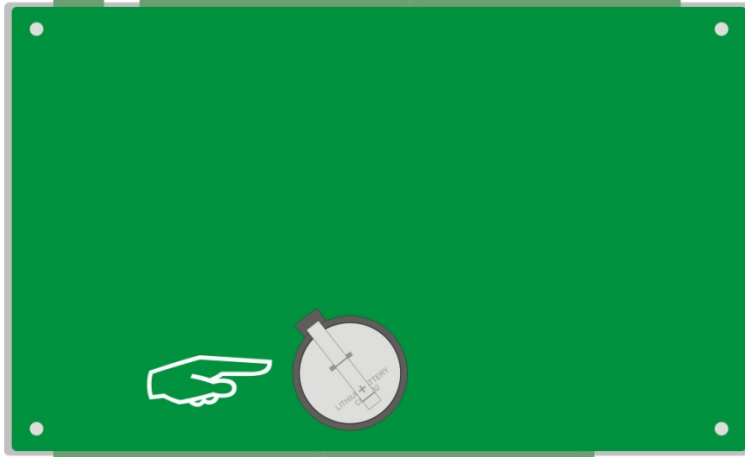

- Insert the new battery and reinstall the back cover and its four screws.

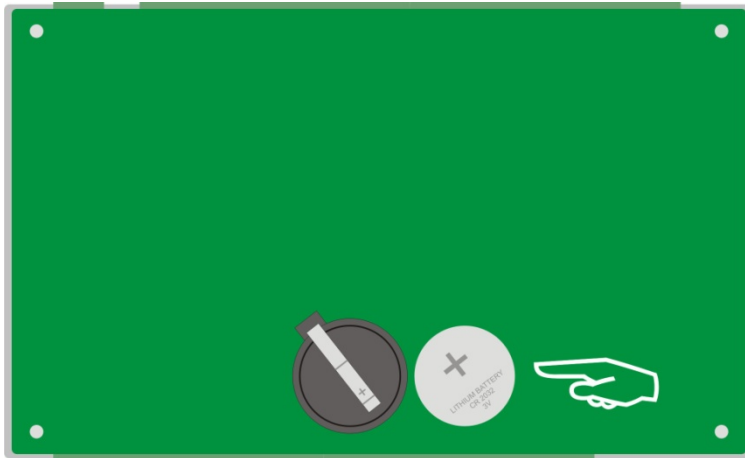

SPECIFICATIONS

Power:

- 100 to 240VAC \pm 10 %, 50/60 Hz. Maximum consumption: 20 VA.

Environmental Conditions: Operating temperature: 32° to 122°F (0° to 50°C). Relative Humidity: 80% to 85°F (30°C). For temperatures above 85°F (30°C), decrease 3% per °C.

For internal use

Electrical Safety: CAT II

Pollution Degree: II

Altitude: < 2000 m

Dimensions: 164 x 117 x 70 mm

Weight: 400 g

Housing: ABS+PC

Protection: IP20

Analog Inputs: The types of input signals accepted by the **Data Logger** and their maximum ranges of measurement are selected in the Configuration software and are listed below.

INPUT TYPE	MEASURING RANGE	ACCURACY
Thermocouple J	-184° to 1832°F (-120 to 1000°C)	\pm 0.2% (F.R.) \pm 1°C
Thermocouple K	-202° to 2501.6°F (-130 to 1372°C)	\pm 0.2% (F.R.) \pm 1°C
Thermocouple T	-202° to 752°F (-130 to 400°C)	\pm 0.2% (F.R.) \pm 1°C
Thermocouple E	-202° to 1436°F (-130 a 780°C)	\pm 0.2% (F.R.) \pm 1°C
Thermocouple N	-202° to 2372°F (-130 to 1300°C)	\pm 0.2% (F.R.) \pm 1°C
Thermocouple R	68° to 3214.4°F (20 to 1768°C)	\pm 0.2% (F.R.) \pm 3°C
Thermocouple S	68° to 3214.4°F (20 to 1768°C)	\pm 0.2% (F.R.) \pm 3°C
Thermocouple B	212° to 3308°F (100 to 1820°C)	\pm 0.2% (F.R.) \pm 3°C
Pt100	-328° to 1562°F (-200 to 850°C)	\pm 0.15% (F.R.)
Pt1000	-328° to 1562°F (-200 to 850°C)	\pm 0.15% (F.R.)
Linear 0 to 20mA	User Programmable	\pm 0.15% (F.R.) *
Linear 4 to 20mA	User Programmable	\pm 0.15% (F.R.) *
Linear 0 to 20mV	User Programmable	\pm 0.15% (F.R.) *
Linear 0 to 50mV	User Programmable	\pm 0.15% (F.R.) *
Linear 0 to 60mV	User Programmable	\pm 0.15% (F.R.) *
Linear -20 to 20mV	User Programmable	\pm 0.15% (F.R.) *
Linear 0 to 5V	User Programmable	\pm 0.15% (F.R.) *
Linear 0 to 10V	User Programmable	\pm 0.15% (F.R.) *

F.R. = Full Range = Span

(*) Note: The full scale refers to the input of the sensor signal and not the range of configured indication.

Table 04 - List of signals accepted by the **Data Logger**

Accuracy is guaranteed at reading intervals greater than 0.2 seconds per channel. For faster scan rates (intervals of less than 0.2 seconds), there will be a loss of accuracy that will increase as the scan rate increases. Although most of the channels can indicate beyond the range limits set, the specification is not guaranteed outside the range.

Input impedance of the analog channels:

- Thermocouples / Pt100 / Pt1000 / mV: > 2M Ω
- mA: 15 Ω + 1.5V
- V: 1.1M Ω

Maximum compensated Pt100/Pt1000 cable resistance: 40 Ω

Excitation current:

- Pt100s: 360 μ A
- Pt1000s: 320 μ A

Digital Inputs:

- Logical levels:
 - Logical level "0": from 0 to 0.8VDC
 - Logical level "1": from 3 to 30VDC
- Maximum input voltage: 30VDC
- Input Current @ 30VDC (typical): 3mA
- Counting:
 - Maximum pulse frequency for counting (square wave): 250Hz
 - Minimum pulse time in logic level "0": 2 ms
 - Minimum pulse time in logic level "1": 2 ms
 - Number of bits for counting: 32

Digital Outputs

- Maximum output voltage: 30VDC
- Maximum output current: 200mA

Relays:

- Maximum Current: 3A @ 250VAC; 3A @ 30VDC

Recording:

- Can log up to 1000 samples per second. Limits: 1 channel at 1000 samples per second or 100 channels at 10 samples per second.
- Can log either in the internal flash memory (2162688 bytes → approximately 512 k measurements) or in the SD card (*).
- Allows the option of circular logging, where, after filling up the memory, the oldest data will be overwritten by more recent data.
- Allows data to be downloaded during logging.

(* **IMPORTANT:** The effective storage rate depends heavily on the quality and speed of the SD card used. It is preferred to use cards of well-known brands. If the desired storage rate is high, use Class IV or above SD cards.

Maximum number of channels that can be logged: 100

Supported file systems: FAT32 e FAT16, both in USB flash drives and SD cards

24V output: 24VDC ± 20% with a minimum load current of 4mA. Maximum load current: 160mA. **This output is not provided in the 24V model.**

Clock battery: Panasonic lithium battery 3V (Part No. CR 2032).

Supported Modbus commands:

- Read Coil Status (01h)
- Read Holding Registers (03h)
- Write Single Coil (05h)
- Write Single Register (06h)
- Write Multiple Registers (0Fh)

Number of simultaneous TCP connections: 10

Number of simultaneous UDP connections: 10

FTP (Data Logger as a server):

Supported mode: passive.

Standard: UNIX.

Number of simultaneous connections: 1.

SMTP (e-mail):

Supported authentication mode: AUTH LOGIN.

Certifications: CE.

REPAIR AND CALIBRATION

To ensure that your instrument meets factory specifications, we recommend that it be submitted to our factory Service Center at one-year intervals for recalibration, or as required by other standards or internal procedures.

For instrument repair and calibration:

You must contact our Service Center for a Customer Service Authorization number (CSA#). This will ensure that when your instrument arrives, it will be tracked and processed promptly. Please write the CSA# on the outside of the shipping container. If the instrument is returned for calibration, we need to know if you want a standard calibration, or a calibration traceable to N.I.S.T. (includes calibration certificate plus recorded calibration data).

Chauvin Arnoux[®], Inc.
d.b.a. AEMC[®] Instruments
15 Faraday Drive
Dover, NH 03820 USA
Tel: (800) 945-2362 (Ext. 360)
(603) 749-6434 (Ext. 360)
Fax: (603) 742-2346 or (603) 749-6309
repair@aemc.com

(Or contact your authorized distributor)

Costs for repair, standard calibration, and calibration traceable to N.I.S.T. are available.

NOTE: All customers must obtain a CSA# before returning any instrument.

TECHNICAL AND SALES ASSISTANCE

If you are experiencing any technical problems, or require any assistance with the proper operation or application of your instrument, please call, mail, fax or e-mail our technical support hotline:

Chauvin Arnoux[®], Inc.
d.b.a. AEMC[®] Instruments
200 Foxborough Boulevard
Foxborough, MA 02035, USA
Phone: (800) 343-1391
(508) 698-2115
Fax: (508) 698-2118
techsupport@aemc.com
www.aemc.com

NOTE: Do not ship Instruments to our Foxborough, MA address

LIMITED WARRANTY

The Data Logger Models DL-1080 and DL-1081 are warranted to the owner for a period of one year from the date of original purchase against defects in manufacture. This limited warranty is given by AEMC® Instruments, not by the distributor from whom it was purchased. This warranty is void if the unit has been tampered with, abused or if the defect is related to service not performed by AEMC® Instruments.

Full warranty coverage and product registration is available on our website at:
www.aemc.com/warranty.html

Please print the online Warranty Coverage Information for your records.

What AEMC® Instruments will do:

If a malfunction occurs within the warranty period, you may return the instrument to us for repair, provided we have your warranty registration information on file or a proof of purchase. AEMC® Instruments will, at its option, repair or replace the faulty material.

WARRANTY REPAIRS

First, request a Customer Service Authorization Number (CSA#) by phone or by fax from our Service Department (see address below), then return the instrument along with the signed CSA Form. Please write the CSA# on the outside of the shipping container. Return the instrument, postage or shipment pre-paid to:

Ship To: Chauvin Arnoux®, Inc. d.b.a. AEMC® Instruments
15 Faraday Drive • Dover, NH 03820 USA
Phone: (800) 945-2362 (Ext. 360)
(603) 749-6434 (Ext. 360)
Fax: (603) 742-2346 or (603) 749-6309
E-mail: repair@aemc.com

Caution: To protect yourself against in-transit loss, we recommend you insure your returned material.

NOTE: You must obtain a CSA# before returning any instrument



04/14

99-MAN 100386 v5

Chauvin Arnoux® , Inc. d.b.a. AEMC® Instruments
15 Faraday Drive • Dover, NH 03820 USA • Phone: (603) 749-6434 • Fax: (603) 742-2346
www.aemc.com

Find Quality Products Online at: www.GlobalTestSupply.com

sales@GlobalTestSupply.com