

TRUE ECHO® RADAR LEVEL SENSOR

General Purpose
CR-L Radar Liquid Level Sensor

Installation Guide

Table of Contents

- | | | |
|------------------------------------|--------------------------|-------------------------|
| 1. Description | 4. General Care | 8. Wiring Information |
| 2. How To Read Your Label | 5. FCC Information | 9. Removal Instructions |
| 3. Warranty and Return Information | 6. Dimensions | 10. True Echo App |
| | 7. Mounting Instructions | 11. Quick Setup |

1 Description

The TRUE ECHO CR-L brings the accurate level readings of radar sensors to industrial liquid measurements. It can accurately measure in many adverse environments. The radar's narrow beam can detect small targets and achieve precise positioning with high resolution. It has a maximum measuring range of 49 feet (15 m) and a minimum blind zone of 8 inches (0.2 m). All TRUE ECHO CR-L sensors can be field calibrated and programmed via the TRUE ECHO app.

2 How To Read Your Label

Each sensor comes with a label on the body with a full model number, a part number, and a serial number. The model number for the TRUE ECHO Radar Level Sensor will look something like this:

SAMPLE: CR-L-GP-49-LI-P-E5-16-B0

The model number correlates with all the configurable options and tells you exactly what you have. Compare the model number to the options on the datasheet to identify your exact configuration. You can also call us with the model, part, or the serial number and we can help you.

3 Warranty and Return Information

This product is covered by APG's warranty to be free from defects in material and workmanship under normal use and service of the product for 24 months. For a full explanation of our Warranty, please visit apgsensors.com/warranty-returns. Contact Technical Support to receive a Return Material Authorization (RMA) before shipping your product back.

If your radar level sensor needs to be returned for evaluation, contact us via email, phone, or on-line chat on our website. We will issue you an RMA number with instructions. You can find RMA & Return form on our website by clicking "RMA" in the web footer, or go to apgsensors.com/RMA-Form

- Phone: 888-525-7300
- Email: sales@apgsensors.com
- Online chat at www.apgsensors.com

Please have your radar part number and serial number available.

4 General Care

Your TRUE ECHO Radar is very low maintenance and will need little care, as long as it is installed correctly. However, in general, you should:

- Avoid applications for which the sensor was not designed, such as extreme temperatures, contact with incompatible corrosive chemicals, or other damaging environments.
- Inspect the threads whenever you remove the sensor from duty or change its location.

5 FCC Information

FCC regulations require 75-85 GHz radars to be installed to ensure a vertically downward orientation at fixed locations only. They must not operate while being moved or while inside a moving container. Hand-held applications are prohibited as well as marketing to residential consumers.

FCC ID: VPKAPGTRUEEC80
Contains Transmitter Module FCC ID:
2ABN2-BG22A3



6 Dimensions

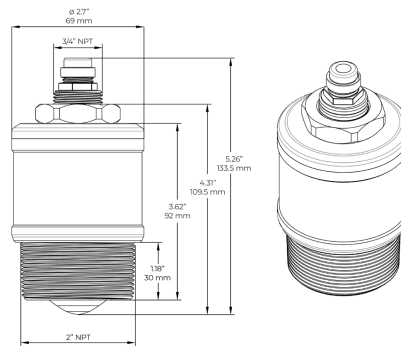

TRUE ECHO CR-L General Purpose Radar

7 Mounting Instructions

- Mount your TRUE ECHO series radar so it has a clear, perpendicular path to the surface being monitored. Your sensor should be mounted away from inlets and outlets.
- The radar path should be free from obstructions and as open as possible for the 4° off axis beam pattern.
- Install the radar at least 8" (20 cm) away from side walls.
- Wrap PTFE tape around threads before installing the radar. **Do NOT over tighten.**
- For proper performance and accuracy, do not suspend by cable without the use of optional weight.

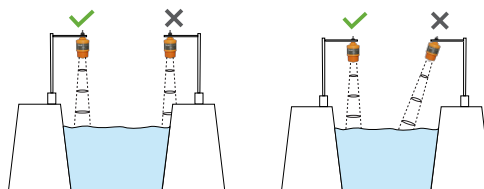

Ensure the radar is installed **perpendicular** to the measured surface. Ensure there are no interferences within the beam angle, such as walls, steps, ladders, river banks, etc.

Install the radar at least 8" (20 cm) away from side walls. When installing in wells or pipes, place the radar as close to the center as possible to avoid interference from side walls.

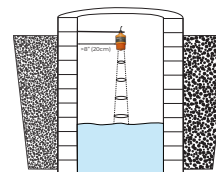

When installing in tanks with domed lids, install **off center** to avoid additional false echoes.

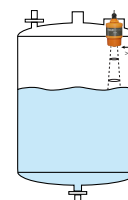

8 Wiring Information

Pin Out Tables

4-20 mA	
Red	Power Supply + 12 to 28 VDC
Black	4-20mA Out
Yellow	Shield, Earth Ground

RS-485	
Red	Power Supply + 12 to 28 VDC
Black	Power Supply Ground -
Blue	RS-485 A+
White	RS-485 B-
Yellow	Shield, Earth Ground

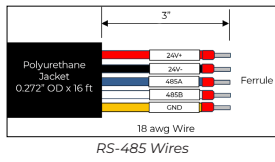
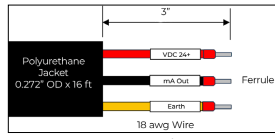

Power Supply Table

Output	Voltage	Typical RMS Current	Peak Current 3.3ms Pulse Every 1sec Update Cycle
4-20 mA	12-28 VDC	4-20 mA	n/a
RS-485	12-28 VDC	—	—
	24 VDC 12 VDC	9-12 mA 14.5-17.6 mA	145 mA 234 mA

9 Removal Instructions

Removing your radar from service must be done with care.

- STEP 1:** Ensure power is turned off.
- STEP 2:** Disconnect the radar wires.
- STEP 3:** Remove the radar from its mount.
- STEP 4:** Store it in a dry place, at a temperature between -40° to 158°F (-40° to 70°C).

10 True Echo App

Use your mobile device to connect wirelessly to your TRUE ECHO Radar, change radar parameters, and view the echo waveform graph.

- STEP 1:** Install the TRUE ECHO app from the app store.
- STEP 2:** Open the TRUE ECHO app. On the Select Device screen, press "Liquid Level Gauge."
- STEP 3:** Each radar's name is displayed with either its Level and Current for 4-20 mA units or its Level and Modbus Address for RS485 units. Press the radar's name to access it.
- STEP 4:** Enter the password. The factory default password is 000000. This can be changed in the app settings.



NOTE: When opening the app for the first time after installation, the app will prompt users to accept the Privacy Policy and will request Location and Relative Position permissions. These permissions are required to connect to the radar.

11 Quick Setup

Setup is simple using the TRUE ECHO App. For best results, adjust the following settings for your specific application, then check the Curve Display to validate sensor readings. Press "Read" to view the current settings in each tab. Press "Write" to save changes.

- **Application Setting:** Use "Liquid" for normal use. Use "Demo" for the quickest responses when demonstrating the radar.
- **Unit Setting:** Select the desired units.
- **High and Low Level Setting:** Set the Low Level to be the distance from the sensor face to the tank bottom or measurement bottom. Set the High Level to be the highest level measured from the sensor face.
- **Range Setting:** Set the Range at or a little longer than the Low Level setting to optimize performance.
- **Current Output:** For 4-20mA units, the Output Mode is set to "4mA Low, 20mA High" by default. It can be changed to "20mA Low, 4mA High" if needed. The Failure Mode is set to "Hold Last Value" by default.
- **RS485 Setting:** For RS-485 units, set the desired Modbus Address, Baud Rate, Parity Bit, and Stop Bit.
- **False Echo Learning:** In the case of obstructions, define the start and end settings to create a false echo mask.

Curve Display: Press the Curve Display button to view the echo waveform graph and validate the radar is sensing the target correctly. The horizontal axis is the distance range, with 0 being the sensor face. The vertical axis is the echo strength in dBs.

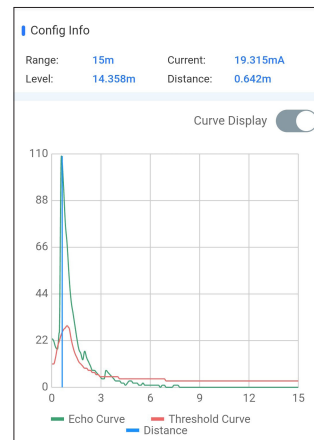
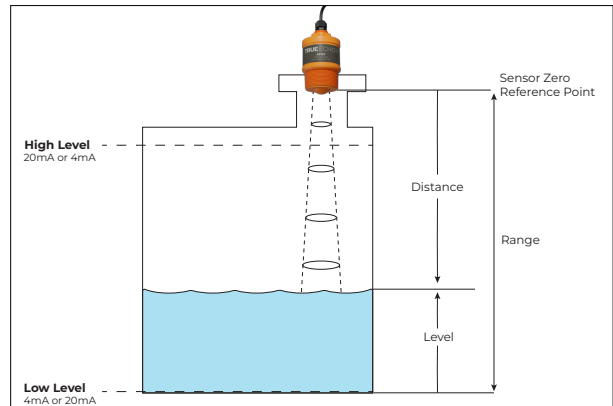

Curve Display